

**UNITED STATES
SECURITIES AND EXCHANGE COMMISSION
Washington, D.C. 20549**

Amendment No. 9

to

FORM S-1

REGISTRATION STATEMENT

UNDER

THE SECURITIES ACT OF 1933

ENPHASE ENERGY, INC.

(Exact name of registrant as specified in its charter)

Delaware
(State or other jurisdiction of
incorporation or organization)

3674
(Primary Standard Industrial
Classification Code Number)

20-4645388
(I.R.S. Employer
Identification Number)

201 1st Street, Suite 100
Petaluma, CA 94952
(707) 774-7000

(Address, including zip code, and telephone number, including area code, of Registrant's principal executive offices)

Paul B. Nahi
Chief Executive Officer
c/o Enphase Energy, Inc.
201 1st Street, Suite 100
Petaluma, CA 94952
(707) 774-7000

(Name, address, including zip code, and telephone number, including area code, of agent for service)

Copies to:

John H. Sellers
Cooley LLP
3175 Hanover Street
Palo Alto, CA 94304
(650) 843-5000

Bruce K. Dallas
Davis Polk & Wardwell LLP
1600 El Camino Real
Menlo Park, CA 94025
(650) 752-2000

Approximate date of commencement of proposed sale to the public: As soon as practicable after the effective date of this registration statement.

If any of the securities being registered on this Form are to be offered on a delayed or continuous basis pursuant to Rule 415 under the Securities Act of 1933, check the following box.

If this Form is filed to register additional securities for an offering pursuant to Rule 462(b) under the Securities Act, check the following box and list the Securities Act registration statement number of the earlier effective registration statement for the same offering.

If this Form is a post-effective amendment filed pursuant to Rule 462(c) under the Securities Act, check the following box and list the Securities Act registration statement number of the earlier effective registration statement for the same offering.

If this Form is a post-effective amendment filed pursuant to Rule 462(d) under the Securities Act, check the following box and list the Securities Act registration number of the earlier effective registration statement for the same offering.

Indicate by check mark whether the registrant is a large accelerated filer, an accelerated filer, a non-accelerated filer, or a smaller reporting company. See the definition of "accelerated filer," "large accelerated filer," "non-accelerated filer" and "smaller reporting company" in Rule 12b-2 of the Act.

Large accelerated filer

Accelerated filer

Non-accelerated filer
(Do not check if a smaller reporting company)

Smaller reporting company

CALCULATION OF REGISTRATION FEE

Title of Each Class of Securities to be Registered	Amount to be Registered(2)	Proposed Maximum Offering Price Per Share(1)	Proposed Maximum Aggregate Offering Price(1)(2)	Amount of Registration Fee(3)(4)
Common Stock, \$0.00001 par value	8,363,636 shares	\$7.00	\$58,545,452	\$6,709.31

(1) Estimated solely for the purpose of calculating the amount of the registration fee in accordance with Rule 457(a) of the Securities Act of 1933, as amended.

(2) Includes 1,090,909 shares that the underwriters have the option to purchase to cover over-allotments, if any.

(3) Calculated pursuant to Rule 457(a) based on an estimate of the proposed maximum aggregate offering price.

(4) The registrant previously paid a registration fee of \$11,610 in connection with the initial filing of this registration statement.

The Registrant hereby amends this Registration Statement on such date or dates as may be necessary to delay its effective date until the Registrant shall file a further amendment that specifically states that this Registration Statement shall thereafter become effective in accordance with Section 8(a) of the Securities Act of 1933, as amended, or until the Registration Statement shall become effective on such date as the Commission, acting pursuant to said Section 8(a), may determine.

[Table of Contents](#)

The information in this prospectus is not complete and may be changed. We may not sell these securities until the registration statement filed with the Securities and Exchange Commission is effective. This prospectus is not an offer to sell these securities and we are not soliciting offers to buy these securities in any state where the offer or sale is not permitted.

PROSPECTUS (Subject to Completion)
Issued March 28, 2012

7,272,727 Shares



Enphase Energy, Inc. is offering 7,272,727 shares of its common stock. This is our initial public offering and no public market currently exists for our shares. We anticipate that the initial public offering price of our common stock will be between \$6.00 and \$7.00 per share.

We have applied for the listing of our common stock on the NASDAQ Global Market under the symbol "ENPH."

Investing in our common stock involves substantial risks. See "[Risk Factors](#)" beginning on page 10.

	PRICE \$	A SHARE		
			Underwriting Discounts and Commissions	Proceeds to Enphase
Per Share				
Total				
	\$		\$	\$
	\$		\$	\$

We have granted the underwriters the right to purchase up to an additional 1,090,909 shares of common stock to cover over-allotments.

Entities affiliated with Third Point LLC ("Third Point"), Madrone Partners, L.P. ("Madrone"), KPCB Holdings, Inc., as nominee ("KPCB") and Bay Partners have indicated an interest in purchasing up to an aggregate of \$15.0 million of shares of our common stock in this offering at the price offered to the public. As of March 1, 2012, each of Third Point, Madrone, KPCB and Bay Partners beneficially owned more than 5% of our common stock and each is affiliated with a member of our board of directors. Because indications of interest are not binding agreements or commitments to purchase, these stockholders may elect not to purchase shares in this offering or the underwriters may elect not to sell any shares in this offering to such stockholders.

The Securities and Exchange Commission and state securities regulators have not approved or disapproved of these securities or determined if this prospectus is truthful or complete. Any representation to the contrary is a criminal offense.

The underwriters expect to deliver the shares of common stock to purchasers on _____, 2012.

MORGAN STANLEY

BofA MERRILL LYNCH

DEUTSCHE BANK SECURITIES

JEFFERIES

LAZARD CAPITAL MARKETS

THINKEQUITY LLC

, 2012

Welcome

to the next phase of solar



[e] enphase
ENERGY

TABLE OF CONTENTS

	<u>Page</u>		<u>Page</u>
Prospectus Summary	1	Compensation Discussion and Analysis	99
Risk Factors	10	Executive Compensation	106
Special Note Regarding Forward-Looking Statements and Industry Data	32	Certain Relationships and Related Party Transactions	124
Use of Proceeds	34	Principal Stockholders	132
Dividend Policy	35	Description of Capital Stock	136
Capitalization	36	Shares Eligible for Future Sale	141
Dilution	38	Material U.S. Federal Income and Estate Tax Consequences to Non-U.S. Holders	144
Selected Consolidated Financial Data	40	Underwriters	147
Management's Discussion and Analysis of Financial Condition and Results of Operations	42	Legal Matters	154
Business	66	Experts	154
Management	91	Where You Can Find More Information	154
		Index to Consolidated Financial Statements	F-1

Neither we nor the underwriters have authorized anyone to provide you with information other than that contained in this prospectus or any free writing prospectus prepared by or on behalf of us or to which we have referred you. We take no responsibility for, and can provide no assurance as to the reliability of, any information that others may give you.

We are offering to sell, and seeking offers to buy, common stock only in jurisdictions where offers and sales are permitted. The information contained in this prospectus is accurate only as of the date of this prospectus, regardless of the time of delivery of this prospectus or of any sale of our common stock.

Until and including [redacted], 2012 (25 days after the date of this prospectus), all dealers that buy, sell or trade our common stock, whether or not participating in this offering, may be required to deliver a prospectus. This delivery requirement is in addition to the obligation of dealers to deliver a prospectus when acting as underwriters and with respect to their unsold allotments or subscriptions.

No action is being taken in any jurisdiction outside the United States to permit a public offering of the common stock or possession or distribution of this prospectus in that jurisdiction. Persons who come into possession of this prospectus in jurisdictions outside the United States are required to inform themselves about and to observe any restrictions as to this offering and the distribution of this prospectus applicable to that jurisdiction.

Unless the context indicates otherwise, we use the terms "Enphase Energy," "Enphase," "we," "us" and "our" in this prospectus to refer to Enphase Energy, Inc. and its subsidiaries.

PROSPECTUS SUMMARY

This summary highlights information contained elsewhere in this prospectus and does not contain all of the information that you should consider in making your investment decision. Before investing in our common stock, you should carefully read this entire prospectus, including our consolidated financial statements and the related notes thereto and the information set forth under the sections “Risk Factors” and “Management’s Discussion and Analysis of Financial Condition and Results of Operations,” in each case appearing elsewhere in this prospectus.

ENPHASE ENERGY, INC.

We deliver microinverter technology for the solar industry that increases energy production, simplifies design and installation, improves system uptime and reliability, reduces fire safety risk and provides a platform for intelligent energy management. To date, the solar industry has relied on the traditional central inverter approach that has largely remained unchanged for the past two decades. We have built from the ground up a semiconductor-based microinverter system that converts direct current (DC) electricity to alternating current (AC) electricity at the individual solar module level, and bring a system-based, high technology approach to solar energy generation leveraging our design expertise across power electronics, semiconductors, networking and embedded and web-based software technologies. We are the market leader in the microinverter category and have grown rapidly since our first commercial shipment in mid-2008, with more than 1,700,000 units sold to date, representing over an estimated 42,000 solar installations. Given significant advantages over traditional central inverters, we believe that microinverter solutions will become the standard for residential and commercial solar.

Our microinverter systems have been installed in all 50 U.S. states and eight Canadian provinces. We sell our microinverter systems primarily to distributors who resell them to solar installers. Over 3,700 installers in North America have installed our microinverters through March 1, 2012, and this number is increasing by approximately 100 new installers per month. We also sell directly to large installers as well as through original equipment manufacturers, or OEMs, and strategic partners. A substantial majority of our revenue has been generated by sales within the United States. Sales to customers in Canada commenced in 2009 and accounted for approximately 12% of our total net revenues in 2011. In the fourth quarter of 2011, we began selling our microinverter systems in France, Italy and the Benelux region.

Market Opportunity

The global solar PV market witnessed rapid growth from 18 gigawatts (GW), or \$75.3 billion, of installed capacity coming online during 2010 to 25 GW, or \$86.3 billion, in 2011. While global solar PV installations are expected to decline 7% to 23 GW in 2012, in future years growth is expected to remain robust, with new solar installations expected to reach 48 GW, or \$105.8 billion, in 2015, according to IHS iSuppli. The solar PV market consists of two primary on-grid solar markets: distributed solar systems for residential and commercial buildings, and centralized large scale solar PV installations owned and operated by utilities.

The global market for inverter technology in 2011 was almost 27 GW, or \$6.8 billion, and the market is expected to grow to 46 GW, or \$10.1 billion, by 2015, according to IMS Research. Historically, traditional central inverters have been the only inverter technology used for solar PV installations. As compared to microinverter systems, we believe that traditional central inverters have a number of design and performance challenges limiting innovation and their ability to reduce cost of solar systems, including the following:

- *Productivity limits.* If solar modules are wired using a traditional central inverter—such that a group or “string” of modules are wired in series—an entire string’s output is limited by the output of the lowest-performing module. Because of its string design, there is a single point of failure risk with the traditional central inverter approach.

- *Reliability issues.* Traditional central inverters are the single most common component of solar installations to fail, resulting in system downtime and adversely impacting total energy output. As a result, central inverters typically carry warranties of only 5 to 10 years.
- *Complex design and installation requirements.* The central inverter-based solar PV installation requires greater effort on the part of the installer, both in terms of design and on-site labor. Central inverter installations require string design and calculations for safe and reliable operation, as well as specialized equipment such as DC combiners, conduits and disconnects. In addition, the use of high-voltage DC requires specialized knowledge and training and safety precautions to install central inverter technology.
- *Lack of monitoring.* The majority of solar installations with central inverter technology offer limited monitoring capabilities. A failure of the central inverter will often go unnoticed for days or even weeks. If a module fails or is not performing to specification, the resulting loss of energy can go unnoticed for an extended period of time.
- *Safety issues.* Central inverter solar PV installations have a wide distribution of high-voltage (600 volts in the United States and 1,000 volts in Europe) DC wiring. If damaged, DC wires can generate sustained electrical arcs, reaching temperatures of more than 5,000 °F. This creates the risk of fire for solar PV installation owners and injury for installers and maintenance personnel.

These challenges of traditional central inverters have a direct impact on the cost and expected return on investment of solar installations to both installers and system owners:

- *Installer.* Solar PV installers aim for simple installation design, fast installation times and maximum system performance and predictability. The installation of high-voltage DC central inverter technology, however, requires significant preparation, precautionary safety measures, time-consuming string calculations, extensive design expertise and specialized installation equipment, training and knowledge. Together, these factors significantly increase complexity and cost of installation and limit overall productivity for the installer.
- *System owner.* Solar system owners aim for high energy production, low cost, high reliability and low maintenance requirements, as well as reduced fire risks. With traditional central inverters, owners often are unable to optimize the size or shape of their solar PV installations due to string design limitations. As such, they experience performance loss from shading and other obstructions, can face frequent system failures and lack the ability to effectively monitor the performance of their solar PV installation. In addition, central inverter installations operate at high-voltage DC which bears significant fire risks. Further, due to their large size, central inverter installations can affect architectural aesthetics of the house or commercial building.

Our Solution

Our microinverter solution brings a system-based, high technology approach to solar energy generation leveraging our design expertise across power electronics, semiconductors, networking, and embedded and web-based software technologies. Our microinverter system consists of three key components: our Enphase microinverter, Envoy communications gateway and Enlighten web-based software:

- Our Enphase microinverter delivers efficient and reliable power conversion at the individual solar module level by introducing a digital architecture that incorporates custom application specific integrated circuits, or ASICs, specialized power electronics devices and an embedded software subsystem that optimizes energy production from each module and manages the core ASIC functions. A residential solar installation consists of 5 to 50 microinverters; a small commercial solar installation consists of 50 to 500 microinverters.

- Our Envoy communications gateway is installed in the system owner's home or business and serves as a networking hub that collects data from the microinverter array and sends the information to our hosted data center. One Envoy is typically sold with each solar installation and can support up to 100 Enphase microinverters.
- Our Enlighten web-based software collects and analyzes this information to enable system owners to monitor and realize the highest performance of their solar PV system and also provides an online portal specifically designed for installers to enable them to track and manage all of their Enphase enabled projects and monitor and analyze the performance of their installed systems. Historically, Enlighten service revenue has represented less than 1% of total revenues in each reporting period.

Together, our Enphase microinverter, Envoy communications gateway and Enlighten web-based software function as a single unified system that enhances energy production, simplifies design and installation, reduces costs, increases system uptime and reliability, reduces fire safety risk and provides the ability to monitor performance at the individual module level in real-time. With an Enphase microinverter system, we believe solar system owners can achieve a higher return on investment over the lifetime of the solar system than would be achieved using a traditional central inverter approach.

Key elements of our solution include:

- *Productive—Superior Energy Production.* Our microinverter system enables the maximum possible energy production from each module, overcoming a fundamental design limitation of central inverters which are limited by the lowest performing module.
- *Reliable—Longer Life and No Single Point of Failure.* Reduction of component count, primarily through semiconductor integration in our microinverter, and the distributed architecture of our microinverter system, allow us to design a reliable system that can withstand harsh environmental conditions and offer system owners a 100% system uptime guarantee.
- *Simple—Ease of Design and Installation.* Using microinverter technology, an installer can design a system of any size and any roof configuration with a simple modular approach, with minimal impact to the aesthetics of a home or building.
- *Smart—Module-Level Monitoring and Analytics.* Our microinverter system allows us to collect energy production information in real-time on a per solar module basis, offering installers and system owners visibility into how their system is performing and the ability to continuously optimize energy production.
- *Safe—"All AC" Solution.* Important to both installers and system owners, microinverters are safer because they process low DC voltages relative to central inverters.

Competitive Strengths

We believe the following combination of capabilities and features of our business model distinguish us from our competitors and position us well to capitalize on the expected growth in the solar market and to become a global leader in the broader solar power industry:

- *Market Leader and Rapid Adoption.* We are the market leader in the microinverter product category, and believe that our proven ability to innovate quickly will continue to allow us to build on our leading market position.
- *System Approach.* By integrating the Enphase microinverter technology with Envoy, our proprietary communications gateway, and our Enlighten web-based software, we offer significant design and operating benefits beyond the core power conversion functionality.

- *Strong Focus on Technology and Research and Development.* Our proximity to Silicon Valley and the past experience of our founders and executive officers in the technology industry have enabled us to recruit engineers with strong skills in power electronics, semiconductors, powerline communications and networking, and software design, which we have complemented with significant solar industry expertise from other members of our team.
- *Field-Proven Reliability.* Our microinverters have established significantly improved reliability relative to traditional central inverter technology. Based on data from a sample of 2009 and 2010 North American residential and small commercial installations, Westinghouse Solar indicates that our microinverters have a failure rate of 0.207% compared to a significantly higher failure rate of 9.43% for traditional central inverters.
- *Capital Efficient and Scalable Manufacturing.* We outsource all of our hardware manufacturing to manufacturing partners, including Flextronics, resulting in a low fixed-cost structure and reduced capital expenditure and working capital requirements.
- *Rapidly Expanding Distribution Channels.* Since we sold our first microinverter system in 2008, the base of installers using our products has grown to over 3,700 installers in North America as of March 1, 2012, and this number is increasing at a rate of approximately 100 each month.
- *Intense Focus on Customer Service for Installers.* We believe we have cultivated an organizational focus on installer satisfaction that differentiates us from central inverter manufacturers, resulting in a high level of installer retention and “repeat” business.

Our Strategy

Our objective is to continue to be the leading provider of microinverter systems for the solar industry worldwide and to accelerate the shift from traditional central inverters to microinverter technology. Key elements of our strategy include:

- *Continue to Penetrate Our Core Markets.* We intend to capitalize on our market leadership in the microinverter category and our growing momentum with installers and owners to further our market share position in our core markets in the United States and Canada.
- *Enter New Geographic Markets Rapidly.* We intend to expand into new markets with new products and local go-to-market capabilities, including further expansion in France, Italy and the Benelux region.
- *Increase Power and Efficiency and Reduce Cost per Watt.* Our engineering team is focused on continuing to increase average power conversion efficiency above 96% and AC output power beyond 215 watts and further reducing cost per watt.
- *Extend Our Technological Innovation.* We distinguish ourselves from other inverter companies with our system-based and high-tech approach, and the ability to leverage strong research and development capabilities.
- *Expand Our Product Offering for Larger Commercial and Utility-Scale Installations.* We intend to expand our product offering by introducing new microinverter systems targeted at larger commercial and utility-scale installations.
- *Development of a Smart Energy Management Platform.* We intend to build upon our strong position as the leading supplier of microinverters and energy management systems to expand beyond solar and to create a smart energy management platform for integrated smart energy devices and services.

Challenges

Before you invest in our stock, you should carefully consider all the information in this prospectus, including matters set forth under the heading “Risk Factors.” We believe that the following are some of the major risks and uncertainties that may affect us:

- *Operating Losses.* We have incurred net losses each year since our inception, and we may continue to incur additional net losses in future years as we continue to invest substantial resources to support the growth of our business.
- *Operating History.* We have only been in existence since 2006 and did not begin shipping our products in commercial quantities until mid-2008, and this limited operating history makes it difficult to evaluate our current business and future prospects.
- *Demand for Solar Energy Solutions.* Our future success depends on continued demand for solar energy solutions and the ability of solar equipment vendors to meet this demand. If the demand for solar energy solutions does not continue to grow or grows at a slower rate than we anticipate, our business will suffer.
- *Government Subsidies.* Reductions in, or eliminations or expirations of, governmental incentives could result in decreased demand for and lower revenue from solar PV systems, which would adversely affect sales of our products.
- *Market Acceptance.* If we fail to achieve broad market acceptance of our products, or fail to develop solutions to address larger commercial and utility scale markets, there would be an adverse impact on our ability to increase our revenue, gain market share and achieve and sustain profitability.
- *Gross Profit and Profitability.* Our gross profit has varied in the past and is likely to continue to vary significantly from period to period, and fluctuations in gross profit may adversely affect our ability to manage our business or achieve or maintain profitability.
- *Competition.* The inverter industry is highly competitive and we expect to face increased competition as new and existing companies introduce microinverter products which could negatively impact our results of operations and market share. SMA Solar Technology AG, Power-One Inc. and SunPower Corp., leading inverter vendors serving the residential and small commercial inverter markets, are expected to introduce microinverter products in 2012. In addition, several new entrants to the microinverter market have recently announced plans to ship or have already shipped products, including some of our OEM customers and partners.
- *Initial Capital Investments.* Our microinverter system requires a higher upfront capital investment than our competition’s central inverter products, and our potential customers may be unwilling to invest more capital upfront, which would negatively impact our growth and sales.

Corporate Information

We were incorporated as PVI Solutions, Inc. in March 2006 in the State of Delaware and changed our name to Enphase Energy, Inc. in July 2007. Our principal executive offices are located at 201 1st Street, Suite 100, Petaluma, CA 94952, USA, and our telephone number is (707) 774-7000. Our website address is www.enphase.com. Information contained on our website is not incorporated by reference into this prospectus, and you should not consider information contained on our website to be part of this prospectus or in deciding whether to purchase shares of our common stock.

Our name is a registered trademark of Enphase Energy, Inc. This prospectus contains additional trade names and trademarks of ours and of other companies.

THE OFFERING

Common stock offered by us	7,272,727 shares
Over-allotment option	1,090,909 shares
Common stock to be outstanding after this offering	37,328,347 shares
Use of proceeds	We anticipate that we will use the net proceeds of this offering primarily for general corporate purposes. Pending the specific use of net proceeds as described in this prospectus, we intend to invest the net proceeds to us from this offering in short-term investment grade and U.S. government securities. See "Use of Proceeds."
Proposed NASDAQ symbol	"ENPH"

Entities affiliated with Third Point LLC ("Third Point"), Madrone Partners L.P. ("Madrone"), KPCB Holdings, Inc., as nominee ("KPCB") and Bay Partners have indicated an interest in purchasing up to an aggregate of \$15.0 million of shares of our common stock in this offering at the price offered to the public. As of March 1, 2012, each of Third Point, Madrone, KPCB and Bay Partners beneficially owned more than 5% of our common stock and each is affiliated with a member of our board of directors. Because these indications of interest are not binding agreements or commitments to purchase, these stockholders may elect not to purchase shares in this offering or the underwriters may elect not to sell any shares in this offering to such stockholders. The underwriters will not receive any underwriting discounts or commissions from any sales of shares to these existing stockholders.

The number of shares of our common stock that will be outstanding immediately after this offering is based on 30,055,620 shares of common stock outstanding as of December 31, 2011, after giving effect to (i) the conversion of our outstanding convertible preferred stock into 25,170,918 shares of common stock immediately prior to the completion of this offering and (ii) the conversion of the outstanding principal amount of our junior secured convertible loan facility and paid-in-kind interest as of December 31, 2011 into 3,186,644 shares of common stock at a conversion price of \$6.50, the midpoint of the price range set forth on the cover page of this prospectus, and excludes:

- 357,459 shares of common stock issuable upon exercise of outstanding warrants as of December 31, 2011, with a weighted-average exercise price of \$5.86 per share;
- 6,255,867 shares of common stock issuable upon the exercise of outstanding stock options under our 2006 Equity Incentive Plan, as of December 31, 2011, with a weighted-average exercise price of \$1.83 per share;
- 2,643,171 shares of common stock reserved for future issuance under our 2011 Equity Incentive Plan, which will become effective prior to the completion of this offering and contains provisions that will automatically increase its share reserve each year, as more fully described in "Executive Compensation—Employee Benefit Plans"; and
- 669,603 shares of common stock reserved for future issuance under our 2011 Employee Stock Purchase Plan, which will become effective prior to the completion of this offering and contains provisions that will automatically increase its share reserve each year, as more fully described in "Executive Compensation—Employee Benefit Plans".

Unless otherwise indicated, all information in this prospectus assumes:

- the automatic conversion of all outstanding shares of our preferred stock into shares of our common stock effective immediately prior to the closing of this offering;

- the automatic conversion of outstanding warrants to purchase shares of our convertible preferred stock into warrants to purchase an aggregate number of 214,930 shares of common stock immediately prior to the completion of this offering;
- the amendment and restatement of our certificate of incorporation and the amendment and restatement of our bylaws immediately upon the completion of this offering;
- the automatic conversion of the outstanding principal amount of our junior secured convertible loan facility and paid-in-kind interest into 3,262,118 shares of common stock upon closing of this offering at a conversion price equal to \$6.50, the midpoint of the price range set forth on the cover page of this prospectus, on April 4, 2012;
- no exercise by the underwriters of their right to purchase up to an additional 1,090,909 shares of common stock from us; and
- a 1-for-9.08 reverse stock split of our common stock and preferred stock, which was effected on March 23, 2012.

The outstanding principal amount of our junior secured convertible loan facility and paid-in-kind interest automatically converts into shares of our common stock upon closing of this offering at a conversion price equal to the lesser of \$8.8984 or the initial public offering price. Because the number of shares that will be issued upon conversion of our junior secured convertible loan facility depends upon the actual initial public offering price per share in this offering and the closing date of this offering, the actual number of shares issuable upon such conversion and the number of shares outstanding following this offering may differ from the number of shares set forth above.

If our junior secured convertible loan facility converts at the initial public offering price, a \$1.00 increase in the assumed initial public offering price of \$6.50 per share, the midpoint of the price range set forth on the cover page of this prospectus, would decrease the number of shares of our common stock issued on conversion of our junior secured convertible loan facility, and therefore the number of shares to be outstanding after this offering, by 434,951 shares, assuming that the closing date of this offering is April 4, 2012. A \$1.00 decrease in the assumed initial public offering price of \$6.50 per share, the midpoint of the price range set forth on the cover page of this prospectus, would increase the number of shares of our common stock issued on conversion of the junior secured convertible loan facility, and therefore the number of shares to be outstanding after this offering, by 593,115 shares, assuming that the closing date of this offering is April 4, 2012. To the extent the closing date of this offering occurs after April 4, 2012, the junior secured convertible loan facility will continue to accrue interest at a rate of 9% and additional shares of our common stock will be issued upon conversion of this additional accrued interest. Likewise, if the closing date occurs prior to April 4, 2012, fewer shares will be issued upon conversion of the junior secured convertible loan facility.

SUMMARY CONSOLIDATED FINANCIAL DATA

The following table summarizes our consolidated financial data. We have derived the summary consolidated statements of operations data for the years ended December 31, 2009, 2010 and 2011 and the consolidated balance sheet data as of December 31, 2011 from our audited consolidated financial statements included elsewhere in this prospectus. Our historical results are not necessarily indicative of our results to be expected in any future period. The summary of our consolidated financial data set forth below should be read together with our consolidated financial statements and the related notes, as well as the section entitled "Management's Discussion and Analysis of Financial Condition and Results of Operations," appearing elsewhere in this prospectus.

	Year Ended December 31,		
	2009	2010	2011
(in thousands, except per share data)			
Consolidated Statements of Operations Data:			
Net revenues	\$ 20,194	\$ 61,661	\$ 149,523
Cost of revenues ⁽¹⁾	23,223	55,159	120,454
Gross profit (loss)	(3,029)	6,502	29,069
Operating expenses:			
Research and development ⁽¹⁾	8,411	14,296	25,099
Sales and marketing ⁽¹⁾	2,651	6,558	17,454
General and administrative ⁽¹⁾	2,603	6,365	15,228
Total operating expenses	13,665	27,219	57,781
Loss from operations	(16,694)	(20,717)	(28,712)
Other income (expense), net:			
Interest income	125	39	4
Interest expense	(356)	(914)	(3,006)
Other income (expense)	—	(185)	(576)
Total other income (expense), net	(231)	(1,060)	(3,578)
Net loss attributable to common stockholders	\$(16,925)	\$(21,777)	\$(32,290)
Net loss per share attributable to common stockholders, basic and diluted	\$ (25.92)	\$ (28.96)	\$ (25.73)
Shares used in computing net loss per share attributable to common stockholders, basic and diluted ⁽²⁾	653	752	1,255
Pro forma net loss per share attributable to common stockholders, basic and diluted ⁽²⁾			\$ (1.26)
Pro forma shares used in computing pro forma net loss per share attributable to common stockholders, basic and diluted ⁽²⁾			27,657

	As of December 31, 2011		
	Actual	Pro Forma ⁽³⁾	Pro Forma as Adjusted ⁽⁴⁾
(in thousands)			
Consolidated Balance Sheet Data:			
Cash and cash equivalents	\$ 51,524	\$ 51,524	\$ 91,738
Working capital	29,417	30,816	71,030
Total assets	106,242	104,759	144,973
Term loans	14,677	14,677	14,677
Convertible notes	19,202	—	—
Convertible preferred stock	93,596	—	—
Common stock and additional paid-in capital	9,103	124,811	165,025
Total stockholders' equity	13,974	33,092	73,306

	Year Ended December 31,		
	2009	2010	2011
(in thousands)			
Other Operating Data:			
Microinverter units sold	126	414	1,002

(1) Includes stock-based compensation expense as follows:

	Year Ended December 31,		
	2009	2010	2011
(in thousands)			
Cost of revenues	\$ 17	\$ 9	\$ 39
Research and development	62	286	795
Sales and marketing	36	256	671
General and administrative	65	278	615
Total stock-based compensation expense	\$ 180	\$ 829	\$ 2,120

- (2) See Note 14 to Consolidated Financial Statements for a description of how we compute basic and diluted net loss attributable to common stockholders, basic and diluted net loss per share attributable to common stockholders and pro forma basic and diluted net loss per share attributable to common stockholders.
- (3) Reflects the conversion of all outstanding shares of preferred stock into 25,170,918 shares of common stock, the conversion of outstanding warrants to purchase 198,256 shares of preferred stock into warrants to purchase 214,930 shares of common stock upon the closing of this offering, and conversion of the outstanding principal amount and paid-in-kind interest under our junior subordinated convertible loan facility into 3,186,644 shares of common stock (at an assumed offering price of \$6.50 per share, which is the midpoint of the price range set forth on the cover of this prospectus).
- (4) Reflects the pro forma adjustments described in (3) above and the sale of 7,272,727 shares of our common stock by us in this offering at an assumed initial public offering price of \$6.50 per share (which is the midpoint of the price range set forth on the cover page of this prospectus), after deducting the estimated underwriting discounts and commissions and estimated offering expenses payable by us in connection with the offering. A \$1.00 increase or decrease in the assumed initial public offering price of \$6.50 per share of common stock would increase or decrease pro forma cash and cash equivalents, working capital, total assets, common stock and additional paid in capital and total stockholders' equity, each by \$6.8 million, assuming the number of shares offered by us, as set forth on the cover page of this prospectus, remains the same and after deducting the estimated underwriting discounts and commissions and estimated offering expenses payable by us in connection with the offering. The pro forma as adjusted information discussed above is illustrative only and will adjust based on the actual public offering price and other terms of this offering determined at pricing.

Because the number of shares that will be issued upon conversion of our junior secured convertible loan facility depends upon the actual initial public offering price per share in this offering and the closing date of this offering, the actual number of shares issuable upon such conversion may differ from the number of shares set forth above. See "Prospectus Summary – The Offering."

RISK FACTORS

You should carefully consider the following risk factors and all other information contained in this prospectus before purchasing our common stock. Investing in our common stock involves a high degree of risk. If any of the following risks actually occurs, we may be unable to conduct our business as currently planned and our financial condition and results of operations could be seriously harmed. In addition, the trading price of our common stock could decline due to the occurrence of any of these risks, and you may lose all or part of your investment. See "Special Note Regarding Forward-Looking Statements and Industry Data" beginning on page 32.

Risks Related to Our Business

We have a history of losses which may continue in the future, and we cannot be certain that we will achieve or sustain profitability.

We have incurred net losses each year since our inception, and we may continue to incur additional net losses in future years as we continue to invest substantial resources to support the growth of our business. We incurred net losses of \$16.9 million, \$21.8 million and \$32.3 million in 2009, 2010 and 2011, respectively. As of December 31, 2011, our accumulated deficit was \$88.8 million. We expect to incur additional costs and expenses related to the continued development and expansion of our business, including in connection with hiring additional personnel, marketing and developing our products, expanding into new product markets and geographies, and maintaining and enhancing our research and development operations. In addition, revenue growth may slow or revenue may decline for a number of possible reasons, many of which are outside our control, including a decline in demand for our offerings, increased competition, a decrease in the growth of the solar industry or our market share, or our failure to continue to capitalize on growth opportunities. If we fail to generate sufficient revenue to support our operations, we may not be able to achieve or sustain profitability.

Our limited operating history makes it difficult to evaluate our current business and future prospects.

We have only been in existence since 2006 and did not begin shipping our products in commercial quantities until mid-2008. Much of our growth has occurred in recent periods. Our limited operating history makes it difficult to evaluate our current business and future prospects. We have encountered and will continue to encounter risks and difficulties frequently experienced by growing companies in rapidly changing industries, including increased expenses as we continue to grow our business. If we do not manage these risks and overcome these difficulties successfully, our business will suffer.

Since we began commercial shipments of our products, our revenue, gross profit and results of operations have varied and are likely to continue to vary from quarter to quarter due to a number of factors, many of which are not within our control. It is difficult for us to accurately forecast our future revenue and gross profit and plan expenses accordingly and, therefore, it is difficult for us to predict our future results of operations.

Further, our efforts to achieve broader market acceptance for our microinverter systems and to expand beyond our existing markets may never succeed, which would adversely impact our ability to generate additional revenue or become profitable.

If demand for solar energy solutions does not continue to grow or grows at a slower rate than we anticipate, our business will suffer.

Our microinverter solution is utilized in solar PV installations, which provide on-site distributed power generation. As a result, our future success depends on continued demand for solar energy solutions and the ability of solar equipment vendors to meet this demand. The solar industry is an evolving industry that has experienced substantial changes in recent years, and we cannot be certain that consumers and businesses will adopt solar PV

[Table of Contents](#)

systems as an alternative energy source at levels sufficient to grow our business. Traditional electricity distribution is based on the regulated industry model whereby businesses and consumers obtain their electricity from a government regulated utility. For alternative methods of distributed power to succeed, businesses and consumers must adopt new purchasing practices. The viability and continued growth in demand for solar energy solutions, and in turn, our products, may be impacted by many factors outside of our control, including:

- market acceptance of solar PV systems based on our product platform;
- cost competitiveness, reliability and performance of solar PV systems compared to conventional and non-solar renewable energy sources and products;
- availability and amount of government subsidies and incentives to support the development and deployment of solar energy solutions;
- the extent to which the electric power industry and broader energy industries are deregulated to permit broader adoption of solar electricity generation;
- the cost and availability of key raw materials and components used in the production of solar PV systems;
- prices of traditional carbon-based energy sources;
- levels of investment by end-users of solar energy products, which tend to decrease when economic growth slows; and
- the emergence, continuance or success of, or increased government support for, other alternative energy generation technologies and products.

If demand for solar energy solutions fails to develop sufficiently, demand for our customers' products as well as demand for our products will decrease, which would have an adverse impact on our ability to increase our revenue and grow our business.

Short-term demand and supply imbalances, especially for solar module technology, recently have caused prices for solar technology solutions to decline rapidly. Furthermore, competition has increased due to the emergence of Asian manufacturers along the entire solar value chain causing further price declines, excess inventory and oversupply. These market disruptions may continue to occur and may increase pressure to reduce prices, which could adversely affect our business and financial results.

The reduction, elimination or expiration of government subsidies and economic incentives for on-grid solar electricity applications could reduce demand for solar PV systems and harm our business.

The market for on-grid applications, where solar power is used to supplement a customer's electricity purchased from the utility network or sold to a utility under tariff, depends in large part on the availability and size of government and economic incentives that vary by geographic market. Because our customers' sales are typically into the on-grid market, the reduction, elimination or expiration of government subsidies and economic incentives for on-grid solar electricity may negatively affect the competitiveness of solar electricity relative to conventional and non-solar renewable sources of electricity, and could harm or halt the growth of the solar electricity industry and our business.

The cost of solar power currently exceeds retail electricity rates, and we believe will continue to do so for the foreseeable future. As a result, national, state and local government bodies in many countries, most notably Canada, France, Germany, Italy, Japan, Republic of China, Spain and the United States, have provided incentives in the form of feed-in tariffs, or FiTs, rebates, tax credits and other incentives to system owners, distributors, system integrators and manufacturers of solar PV systems to promote the use of solar electricity in on-grid applications and to reduce dependency on other forms of energy. Many of these government incentives expire, phase out over time, terminate upon the exhaustion of the allocated funding, require renewal by the applicable

[Table of Contents](#)

authority or are being amended by governments due to changing market circumstances or changes to national, state or local energy policy.

To date we have generated substantially all of our revenues from North America and expect to generate a substantial amount of revenues from North America in the future. There are a number of important incentives that are expected to phase-out or terminate in the future, which could adversely affect sales of our products. A substantial majority of our revenues come from the United States, which has both federal and state incentives. The Renewable Energy and Job Creation Act of 2008 provides a 30% federal tax credit for residential and commercial solar installations. The American Recovery and Reinvestment Act of 2009, as amended, created a renewable energy grant program that offered cash payments in lieu of investment tax credits to renewable energy project developers for eligible property placed in service prior to December 31, 2011 or placed in service by the specified credit termination date, if construction began prior to December 31, 2011. The guidelines include a “safe harbor” provision setting the beginning of construction at the point where the applicant has incurred or paid at least 5% of the total cost of the property, excluding land and certain preliminary planning activities. We believe the December 31, 2011 deadline associated with this program had a positive effect on our sales in the fourth quarter of 2011, as customers and installers took actions to begin construction or place eligible property into service before the deadline. While we expect this to continue to have a positive impact on our revenues for the first half of 2012 as deferred revenues recorded in connection with these sales are recognized, unless this program is further extended, the eventual phase-out of this program could adversely affect sales of our products in the future.

California is the largest single solar market in the United States, based on SEIA data, and a significant portion of our revenues are generated in California. In 2007, the State of California launched its 10-year, \$3 billion “Go Solar California” campaign, which encourages the installation of an aggregate of 3,000 MW of solar energy systems in homes and businesses by the end of 2016. The largest part of the campaign, the “California Solar Initiative,” provides performance-based incentives which decrease in intervals over time. The “Go Solar California” program is scheduled to expire on December 31, 2016.

We also sell our products in Ontario, Canada, and consider this an important market. The Ontario Power Authority Green Energy and Green Economy Act of 2009 created two separate FiT programs for projects greater than 10kW and for projects less than 10kW. These FiT programs provide participants with a fixed price for the electricity produced over a 20-year contract term. The Government of Ontario has the authority to change the FiTs for future contracts at its discretion.

In the fourth quarter of 2011, we began selling our products in France, Italy and the Benelux region. A number of European countries, including Germany, Italy and the United Kingdom, have adopted reductions to their FiTs, and Spain recently announced a temporary suspension of all subsidies for new renewable energy projects. As we do increased business in Europe, reductions in European tariffs and subsidies could negatively affect our business, financial condition and results of operations.

Electric utility companies or generators of electricity from other non-solar renewable sources of electricity may successfully lobby for changes in the relevant legislation in their markets that are harmful to the solar industry. Reductions in, or eliminations or expirations of, governmental incentives could result in decreased demand for and lower revenue from solar PV systems, which would adversely affect sales of our products. In addition, our ability to successfully penetrate new geographic markets may depend on new countries adopting and maintaining incentives to promote solar electricity, to the extent such incentives are not currently in place.

Our microinverter systems may not achieve broad market acceptance, which would prevent us from increasing our revenue and market share.

If we fail to achieve broad market acceptance of our products, there would be an adverse impact on our ability to increase our revenue, gain market share and achieve and sustain profitability. Our ability to achieve broad market acceptance for our products will be impacted by a number of factors, including:

- our ability to timely introduce and complete new designs and timely qualify and certify our products;
- whether installers and system owners will continue to adopt our microinverter solution, which is a relatively new technology with a limited history with respect to reliability and performance;
- whether installers and system owners will be willing to purchase microinverter systems from us given our limited operating history;
- the ability of prospective system owners to obtain long-term financing for solar PV installations based on our product platform on acceptable terms or at all;
- our ability to produce microinverter systems that compete favorably against other solutions on the basis of price, quality, reliability and performance;
- our ability to develop products that comply with local standards and regulatory requirements, as well as potential in-country manufacturing requirements; and
- our ability to develop and maintain successful relationships with our customers and suppliers.

In addition, our ability to achieve increased market share will depend on our ability to increase sales to established solar installers, who have traditionally sold central inverters. These installers often have made substantial investments in design, installation resources and training in traditional central inverter systems, which may create challenges for us to achieve their adoption of our microinverter solution.

Our gross profit may fluctuate over time, which could impair our ability to achieve or maintain profitability.

Our gross profit has varied in the past and is likely to continue to vary significantly from period to period. Our gross profit may be adversely affected by numerous factors, some of which are beyond our control, including:

- changes in customer, geographic or product mix;
- increased price competition, including the impact of customer discounts and rebates;
- our ability to reduce and control product costs;
- loss of cost savings due to changes in component or raw material pricing or charges incurred due to inventory holding periods if product demand is not correctly anticipated;
- introduction of new products;
- price reductions on older generation products to sell remaining inventory;
- our ability to reduce production costs, such as through technology innovations, in order to offset price declines in older products over time;
- changes in shipment volume;
- changes in distribution channels;
- increased warranty costs and reserves;
- excess and obsolete inventory and inventory holding charges; and
- expediting costs incurred to meet customer delivery requirements.

Fluctuations in gross profit may adversely affect our ability to manage our business or achieve or maintain profitability.

The inverter industry is highly competitive and we expect to face increased competition as new and existing competitors introduce microinverter products, which could negatively impact our results of operations and market share.

To date, we have competed primarily against central inverter manufacturers and have faced almost no direct competition in selling our microinverter systems. Marketing and selling our microinverter solutions against traditional inverter solutions is highly competitive, and we expect competition to intensify as new and existing competitors enter the microinverter market. We believe that a number of companies have developed or are developing microinverters and other products that will compete directly with our microinverter systems. SMA Solar Technology AG, Power-One Inc. and SunPower Corp., leading inverter vendors serving the residential and small commercial inverter markets, are expected to introduce microinverter products in 2012. In addition, several new entrants to the microinverter market have recently announced plans to ship or have already shipped products, including some of our OEM customers and partners.

Currently, competitors in the inverter market range from large companies such as SMA Solar Technology AG, Fronius International GmbH and Power-One Inc. to emerging companies offering alternative microinverter or other solar electronics products. Some of our competitors have announced plans to introduce microinverter products that could compete with our microinverter systems. Several of our existing and potential competitors are significantly larger, have greater financial, marketing, distribution, customer support and other resources, are more established than we are, and have significantly better brand recognition. Some of our competitors have more resources to develop or acquire, and more experience in developing or acquiring, new products and technologies and in creating market awareness for these products and technologies. Further, certain competitors may be able to develop new products more quickly than us and may be able to develop products that are more reliable or which provide more functionality than ours. In addition, some of our competitors have the financial resources to offer competitive products at aggressive or below-market pricing levels, which could cause us to lose sales or market share or require us to lower prices for our microinverter systems in order to compete effectively. Suppliers of solar products, particularly solar modules, have experienced eroding prices over the last several years and as a result many have faced margin compression and declining revenues. If we have to reduce our prices by more than we anticipated, or if we are unable to offset any future reductions in our average selling prices by increasing our sales volume, reducing our costs and expenses or introducing new products, our revenues and gross profit would suffer.

We also may face competition from some of our customers who evaluate our capabilities against the merits of manufacturing products internally. For instance, solar module manufacturers could attempt to develop components that directly perform DC to AC conversion in the module itself. Due to the fact that such customers may not seek to make a profit directly from the manufacture of these products, they may have the ability to manufacture competitive products at a lower cost than we would charge such customers. As a result, these customers may purchase fewer of our microinverter systems or sell products that compete with our microinverters systems, which would negatively impact our revenue and gross profit.

If we are unable to effectively manage our growth, our business and operating results may suffer.

We have recently experienced, and expect to continue to experience, significant growth in our sales and operations. Our historical growth has placed, and planned future growth is expected to continue to place, significant demands on our management, as well as our financial and operational resources, to:

- manage a larger organization;
- expand third-party manufacturing, testing and distribution capacity;

[Table of Contents](#)

- build additional custom manufacturing test equipment;
- manage an increasing number of relationships with customers, suppliers and other third parties;
- increase our sales and marketing efforts;
- train and manage a growing employee base;
- broaden our customer support capabilities;
- implement new and upgrade existing operational and financial systems; and
- enhance our financial disclosure controls and procedures.

We cannot assure you that our current and planned operations, personnel, systems, internal procedures and controls will be adequate to support our future growth. If we cannot manage our growth effectively, we may be unable to take advantage of market opportunities, execute our business strategies or respond to competitive pressures, any of which could have a material adverse effect on our financial condition, results of operation, business or prospects.

Our planned expansion into new markets could subject us to additional business, financial and competitive risks.

We currently offer microinverter systems targeting the residential and commercial markets in North America, France, Italy and the Benelux region. However, we intend to introduce new microinverter systems targeted at larger commercial and utility-scale installations and to expand into other international markets. Our success in these new product and geographic markets will depend on a number of factors, such as:

- timely qualification and certification of new products for larger commercial and utility-scale installations;
- acceptance of microinverters in markets in which they have not traditionally been used;
- our ability to compete in new product markets to which we are not accustomed;
- our ability to manage an increasing manufacturing capacity and production;
- willingness of our potential customers to incur a higher upfront capital investment than may be required for competing solutions;
- our ability to develop solutions to address the requirements of the larger commercial and utility-scale markets;
- our ability to reduce production costs in order to price our products competitively over time;
- accurate forecasting and effective management of inventory levels in line with anticipated product demand; and
- our customer service capabilities and responsiveness.

Further, new geographic markets and the larger commercial and utility-scale installation markets have different characteristics from the markets in which we currently sell products, and our success will depend on our ability to properly address these differences. These differences may include:

- differing regulatory requirements, including tax laws, trade laws, labor regulations, tariffs, export quotas, customs duties or other trade restrictions;
- limited or unfavorable intellectual property protection;
- risk of change in international political or economic conditions;

Table of Contents

- restrictions on the repatriation of earnings;
- fluctuations in the value of foreign currencies and interest rates;
- difficulties and increased expenses in complying with a variety of U.S. and foreign laws, regulations and trade standards, including the Foreign Corrupt Practices Act;
- potentially longer sales cycles;
- higher volume requirements;
- increased customer concentrations;
- warranty expectations and product return policies; and
- cost, performance and compatibility requirements.

Failure to develop and introduce these new products successfully, to generate sufficient revenue from these products to offset associated research and development, marketing and manufacturing costs, or to otherwise effectively anticipate and manage the risks and challenges associated with our potential expansion into new product and geographic markets, could adversely affect our revenues and our ability to achieve or sustain profitability.

A drop in the retail price of electricity derived from the utility grid or from alternative energy sources may harm our business, financial condition and results of operations.

We believe that a system owner's decision to purchase a solar PV system is strongly influenced by the cost of electricity generated by solar PV installations relative to the retail price of electricity from the utility grid and the cost of other renewable energy sources, including electricity from solar PV installations using central inverters. Decreases in the retail prices of electricity from the utility grid would make it more difficult for all solar PV systems to compete. In particular, growth in unconventional natural gas production and an increase in global liquefied natural gas capacity are expected to keep natural gas prices relatively low for the foreseeable future. Persistent low natural gas prices, lower prices of electricity produced from other energy sources, such as nuclear power, or improvements to the utility infrastructure could reduce the retail price of electricity from the utility grid, making the purchase of solar PV systems less economically attractive and lowering sales of our microinverter systems. In addition, energy conservation technologies and public initiatives to reduce demand for electricity also could cause a fall in the retail price of electricity from the utility grid. Moreover, technological developments by our competitors in the solar components industry, including manufacturers of central inverters, could allow these competitors or their partners to offer electricity at costs lower than those that can be achieved from solar PV installations based on our product platform, which could result in reduced demand for our products. If the cost of electricity generated by solar PV installations incorporating our microinverter systems is high relative to the cost of electricity from other sources, our business, financial condition and results of operations may be harmed.

Problems with product quality or product performance may cause us to incur warranty expenses and may damage our market reputation and cause our revenue to decline.

We have offered 15-year limited warranties for our first and second generation microinverters and offer a 25-year limited warranty on our third generation microinverters. Our limited warranties cover defects in materials and workmanship of our microinverters under normal use and service conditions for up to 25 years following installation. As a result, we bear the risk of warranty claims long after we have sold product and recognized revenue. Our estimated costs of warranty for previously sold products may change to the extent future products are not compatible with earlier generation products under warranty.

While we offer 15 or 25-year warranties, our microinverters have only been in use since mid-2008, when we first commenced commercial sales of our products. Although we conduct accelerated life cycle testing to

[Table of Contents](#)

measure performance and reliability, our microinverter systems have not been tested over the full warranty cycle and do not have a sufficient operating history to confirm how they will perform over their estimated useful life. In addition, under real-world operating conditions, which may vary by location and design, as well as insolation, soiling and weather conditions, a typical solar PV installation may perform in a different way than under standard test conditions. If our products perform below expectations or have unexpected reliability problems, we may be unable to gain or retain customers and could face substantial warranty expense. In addition, any widespread product failures may damage our market reputation and cause us to lose customers.

Because of the limited operating history of our products, we have been required to make assumptions and apply judgments, based on our accelerated life cycle testing, regarding a number of factors, including our anticipated rate of warranty claims and the durability and reliability of our products. Our assumptions could prove to be materially different from the actual performance of our products, causing us to incur substantial expense to repair or replace defective products in the future. An increase in our estimates of future warranty obligations due to product failure rates, shipment volumes, field service obligations and rework costs incurred in correcting product failures, could cause us to increase the amount of warranty reserves and have a corresponding negative impact on our results of operations.

If we do not forecast demand for our products accurately, we may experience product shortages, delays in product shipment, excess product inventory, or difficulties in planning expenses, which will adversely affect our business and financial condition.

We manufacture our products according to our estimates of customer demand. This process requires us to make multiple forecasts and assumptions relating to the demand of our distributors, their end customers and general market conditions. Because we sell most of our products to distributors, who in turn sell to their end customers, we have limited visibility as to end-customer demand. We depend significantly on our distributors to provide us visibility into their end customer demand, and we use these forecasts to make our own forecasts and planning decisions. If the information from our distributors turns out to be incorrect, then our own forecasts may also be inaccurate. Furthermore, we do not have long-term purchase commitments from our distributors or end customers, and our sales are generally made by purchase orders that may be cancelled, changed or deferred without notice to us or penalty. As a result, it is difficult to forecast future customer demand to plan our operations.

If we overestimate demand for our products, or if purchase orders are cancelled or shipments are delayed, we may have excess inventory that we cannot sell. Historically, provisions for write-downs of inventories have not been significant. In the future we may have to make significant provisions for inventory write-downs based on events that are currently not known, and such provisions or any adjustments to such provisions could be material. Conversely, if we underestimate demand, we may not have sufficient inventory to meet end-customer demand, and we may lose market share, damage relationships with our distributors and end customers and forego potential revenue opportunities. Obtaining additional supply in the face of product shortages may be costly or impossible, particularly in the short term and in light of our outsourced manufacturing processes, which could prevent us from fulfilling orders in a timely and cost efficient manner or at all. In addition, if we overestimate our production requirements, our contract manufacturers may purchase excess components and build excess inventory. If our contract manufacturers, at our request, purchase excess components that are unique to our products and are unable to recoup the costs of such excess through resale or return or build excess products, we could be required to pay for these excess parts or products and recognize related inventory write-downs.

In addition, we plan our operating expenses, including research and development expenses, hiring needs and inventory investments, in part on our estimates of customer demand and future revenue. If customer demand or revenue for a particular period is lower than we expect, we may not be able to proportionately reduce our fixed operating expenses for that period, which would harm our operating results for that period.

[Table of Contents](#)

We depend upon a small number of outside contract manufacturers. Our operations could be disrupted if we encounter problems with these contract manufacturers.

We do not have internal manufacturing capabilities, and rely upon a small number of contract manufacturers to build our products. In particular, we rely on contract manufacturers for the manufacture of microinverter products, cabling and our communications gateway related to our microinverter systems. Our reliance on a small number of contract manufacturers makes us vulnerable to possible capacity constraints and reduced control over component availability, delivery schedules, manufacturing yields and costs. We do not have long-term supply contracts with our other manufacturing partners. Consequently, these manufacturers are not obligated to supply products to us for any period, in any specified quantity or at any certain price.

The revenues that our contract manufacturers generate from our orders represent a relatively small percentage of their overall revenues. As a result, fulfilling our orders may not be considered a priority in the event of constrained ability to fulfill all of their customer obligations in a timely manner. In addition, the facilities in which our microinverters, related cabling and communications gateway products are manufactured are located outside of the United States. We believe that the location of these facilities outside of the United States increases supply risk, including the risk of supply interruptions or reductions in manufacturing quality or controls.

If any of our contract manufacturers were unable or unwilling to manufacture our products in required volumes and at high quality levels or renew existing terms under supply agreements, we would have to identify, qualify and select acceptable alternative contract manufacturers. An alternative contract manufacturer may not be available to us when needed or may not be in a position to satisfy our quality or production requirements on commercially reasonable terms, including price. Any significant interruption in manufacturing would require us to reduce our supply of products to our customers, which in turn would reduce our revenues, harm our relationships with our customers and damage our relationships with our distributors and end customers and cause us to forego potential revenue opportunities.

Manufacturing problems could result in delays in product shipments to customers and could adversely affect our revenue, competitive position and reputation.

We may experience delays, disruptions or quality control problems in our manufacturing operations. Our product development, manufacturing and testing processes are complex and require significant technological and production process expertise. Such processes involve a number of precise steps from design to production. Any change in our processes could cause one or more production errors, requiring a temporary suspension or delay in our production line until the errors can be researched, identified and properly addressed and rectified. This may occur particularly as we introduce new products, modify our engineering and production techniques, and/or expand our capacity. In addition, our failure to maintain appropriate quality assurance processes could result in increased product failures, loss of customers, increased production costs and delays. Any of these developments could have a material adverse effect on our business, financial condition, and results of operations.

A disruption could also occur in our manufacturing partner's fabrication facility due to any number of reasons, such as equipment failure, contaminated materials or process deviations, which could adversely impact manufacturing yields or delay product shipments. As a result, we could incur additional costs that would adversely affect our gross profit, and product shipments to our customers could be delayed beyond the shipment schedules requested by our customers, which would negatively affect our revenue, competitive position and reputation.

Additionally, manufacturing yields depend on a number of factors, including the stability and manufacturability of the product design, manufacturing improvements gained over cumulative production volumes and the quality and consistency of component parts. Capacity constraints, raw materials shortages, logistics issues, labor shortages, changes in customer requirements, manufacturing facilities or processes, or those of some third-party contract manufacturers and suppliers of raw materials and components have historically caused, and may in the future cause, reduced manufacturing yields, negatively impacting the gross profit on, and

[Table of Contents](#)

our production capacity for, those products. Moreover, an increase in the rejection and rework rate of products during the quality control process before, during or after manufacture would result in our experiencing lower yields, gross profit and production capacity.

The risks of these types of manufacturing problems are further increased during the introduction of new product lines, which has from time to time caused, and may in the future cause, temporary suspension of production lines while problems are addressed or corrected. Since our business is substantially dependent on a limited number of product lines, any prolonged or substantial suspension of manufacturing production lines could result in a material adverse effect on our revenue, gross profit, competitive position, and distributor and customer relationships.

We depend on sole source and limited source suppliers for key components and products. If we are unable to source these components on a timely basis, we will not be able to deliver our products to our customers.

We depend on sole source and limited source suppliers for key components of our products. For example, our ASICs are purchased from a sole source supplier or developed for us by sole source suppliers. Any of the sole source and limited source suppliers upon whom we rely could stop producing our components, cease operations or be acquired by, or enter into exclusive arrangements with, our competitors. We generally do not have long-term supply agreements with our suppliers, and our purchase volumes are currently too low for us to be considered a priority customer by most of our suppliers. As a result, most of these suppliers could stop selling to us at commercially reasonable prices, or at all. Any such interruption or delay may force us to seek similar components or products from alternative sources, which may not be available on commercially reasonable terms, including price, or at all. Switching suppliers may require that we redesign our products to accommodate new components, and may potentially require us to re-qualify our products, which would be costly and time-consuming. Any interruption in the supply of sole source or limited source components for our products would adversely affect our ability to meet scheduled product deliveries to our customers, could result in lost revenue or higher expenses and would harm our business.

If we or our contract manufacturers are unable to obtain raw materials in a timely manner or if the price of raw materials increases significantly, production time and product costs could increase, which may adversely affect our business.

The manufacturing and packaging processes used by our contract manufacturers depend on raw materials such as copper, aluminum, silicon and petroleum-based products. From time to time, suppliers may extend lead times, limit supplies or increase prices due to capacity constraints or other factors. Certain of our suppliers have the ability to pass along to us directly or through our contract manufacturers any increases in the price of raw materials. If the prices of these raw materials rise significantly, we may be unable to pass on the increased cost to our customers. While we may from time to time enter into hedging transactions to reduce our exposure to wide fluctuations in the cost of raw materials, the availability and effectiveness of these hedging transactions may be limited. Due to all these factors, our results of operations could be adversely affected if we or our contract manufacturers are unable to obtain adequate supplies of raw materials in a timely manner or at reasonable cost. In addition, from time to time, we or our contract manufacturers may need to reject raw materials that do not meet our specifications, resulting in potential delays or declines in output. Furthermore, problems with our raw materials may give rise to compatibility or performance issues in our products, which could lead to an increase in customer returns or product warranty claims. Errors or defects may arise from raw materials supplied by third parties that are beyond our detection or control, which could lead to additional customer returns or product warranty claims that may adversely affect our business and results of operations.

If potential owners of solar PV systems based on our product platform are unable to secure financing on acceptable terms, we could experience a reduction in the demand for our solar PV systems.

Many owners of solar PV systems depend on financing to purchase their systems. The limited use of microinverters to date, coupled with our limited operating history, could result in lenders refusing to provide the

financing necessary to purchase solar PV systems based on our product platform on favorable terms, or at all. Moreover, in the case of debt financed projects, even if lenders are willing to finance the purchase of these systems, an increase in interest rates or a change in tax incentives could make it difficult for owners to secure the financing necessary to purchase a solar PV system on favorable terms, or at all. In addition, we believe that a significant percentage of owners purchase solar PV systems as an investment, funding the initial capital expenditure through a combination of upfront cash and financing. Difficulties in obtaining financing for solar PV installations on favorable terms, or increases in interest rates or changes in tax incentives, could lower an investor's return on investment in a solar PV installation, or make alternative solar PV systems or other investments more attractive relative to solar PV systems based on our product platform. Any of these events could result in reduced demand for our products, which could have a material adverse effect on our financial condition and results of operations.

We rely primarily on distributors to assist in selling our products, and the failure of these distributors to perform as expected could reduce our future revenue.

We sell our microinverter systems primarily through distributors, as well as through direct sales to solar equipment installers. For the year ended December 31, 2011, Focused Energy, Inc., Sunwize Technologies, Inc., and Solarnet Holdings, LLC collectively accounted for 38% of our total net revenues. In 2010, Focused Energy, Inc. and DC Power Systems, collectively accounted for 25% of our total net revenues. We do not have exclusive arrangements with these third parties and, as a result, many of our distributors also market and sell products from our competitors, which may reduce our sales. Our distributors may terminate their relationships with us at any time, or with short notice. Our distributors may fail to devote resources necessary to sell our products at the prices, in the volumes and within the time frames that we expect, or may focus their marketing and sales efforts on products of our competitors. Our future performance depends on our ability to effectively manage our relationships with our existing distributors, as well as to attract additional distributors that will be able to market and support our products effectively, especially in markets in which we have not previously distributed our products. Termination of agreements with current distributors, failure by these distributors to perform as expected, or failure by us to cultivate new distributor relationships, could hinder our ability to expand our operations and harm our revenue and operating results.

Ordering patterns from our distributors may cause our revenue to fluctuate significantly from period to period.

Our distributors place purchase orders with us based on their assessment of end-customer demand and their forecasts. Because these forecasts may not be accurate, channel inventory held at our distributors may fluctuate significantly due to the difference between their forecasts and actual demand. As a result, distributors adjust their purchase orders placed with us in response to changing channel inventory levels, as well as their assessment of the latest market demand trends. We have limited visibility into future end customer demand. A significant decrease in our distributors' channel inventory in one period may lead to a significant rebuilding of channel inventory in subsequent periods, or vice versa, which may cause our quarterly revenue and operating results to fluctuate significantly. This fluctuation may cause our results to fall short of analyst or investor expectations in a certain period, which may cause our stock price to decline.

Our success in an "AC module" version of our microinverter system may depend in part upon our ability to continue to work closely with leading solar module manufacturers.

We are currently working on a variant of our microinverter system that will enable an "AC module" for direct attachment of the microinverter to the backsheet of the solar modules. The market success of such solutions will depend in part on our ability to continue to work closely with solar module manufacturers to design solar modules that are compatible with such direct attachment microinverter solutions. We may not be able to encourage solar module manufacturers to work with us on the development of such compatible solutions combining our microinverter system and solar modules for a variety of reasons, including differences in marketing or selling strategy, competitive considerations, lack of competitive pricing, and technological compatibility.

[Table of Contents](#)

If we fail to retain our key personnel or if we fail to attract additional qualified personnel, we may not be able to achieve our anticipated level of growth and our business could suffer.

Our future success and ability to implement our business strategy depends, in part, on our ability to attract and retain key personnel, and on the continued contributions of members of our senior management team and key technical personnel, each of whom would be difficult to replace. All of our employees, including our senior management, are free to terminate their employment relationships with us at any time. Competition for highly skilled technical people is extremely intense, and we face challenges identifying, hiring and retaining qualified personnel in many areas of our business. If we fail to retain our senior management and other key personnel or if we fail to attract additional qualified personnel, we may not be able to achieve our strategic objectives and our business could suffer.

If we fail to protect, or incur significant costs in defending, our intellectual property and other proprietary rights, our business and results of operations could be materially harmed.

Our success depends to a significant degree on our ability to protect our intellectual property and other proprietary rights. We rely on a combination of patent, trademark, copyright, trade secret and unfair competition laws, as well as confidentiality and license agreements and other contractual provisions, to establish and protect our intellectual property and other proprietary rights. We have applied for patent and trademark registrations in the United States and in certain other countries, some of which have been issued. We cannot guarantee that any of our pending applications will be approved or that our existing and future intellectual property rights will be sufficiently broad to protect our proprietary technology, and any failure to obtain such approvals or finding that our intellectual property rights are invalid or unenforceable could force us to, among other things, rebrand or re-design our affected products. In countries where we have not applied for patent protection or where effective intellectual property protection is not available to the same extent as in the United States, we may be at greater risk that our proprietary rights will be misappropriated, infringed or otherwise violated.

To protect our unregistered intellectual property, including our trade secrets and know-how, we rely in part on trade secret laws and confidentiality and invention assignment agreements with our employees and independent consultants. We also require other third parties who may have access to our proprietary technologies and information to enter into non-disclosure agreements. Such measures, however, provide only limited protection, and we cannot assure that our confidentiality and non-disclosure agreements will prevent unauthorized disclosure or use of our confidential information, especially after our employees or third parties end their employment or engagement with us, or provide us with an adequate remedy in the event of such disclosure. Furthermore, competitors or other third parties may independently discover our trade secrets, in which case we would not be able to assert trade secret rights, copy or reverse engineer our products or portions thereof or develop similar technology. If we fail to protect our intellectual property and other proprietary rights, or if such intellectual property and proprietary rights are infringed, misappropriated or otherwise violated, our business, results of operations or financial condition could be materially harmed.

In the future, we may need to take legal action to prevent third parties from infringing upon or misappropriating our intellectual property or from otherwise gaining access to our technology. Protecting and enforcing our intellectual property rights and determining their validity and scope could result in significant litigation costs and require significant time and attention from our technical and management personnel, which could significantly harm our business. In addition, we may not prevail in such proceedings. An adverse outcome of any such proceeding may reduce our competitive advantage or otherwise harm our financial condition and our business.

Third parties may assert that we are infringing upon their intellectual property rights, which could divert management's attention, cause us to incur significant costs and prevent us from selling or using the technology to which such rights relate.

Our competitors and other third parties hold numerous patents related to technology used in our industry, and claims of patent or other intellectual property right infringement or violation have been litigated against certain of

[Table of Contents](#)

our competitors. From time to time we may also be subject to such claims and litigation. Regardless of their merit, responding to such claims can be time consuming, divert management's attention and resources and may cause us to incur significant expenses. While we believe that our products and technology do not infringe in any material respect upon any valid intellectual property rights of third parties, we cannot be certain that we would be successful in defending against any such claims. Furthermore, patent applications in the United States and most other countries are confidential for a period of time before being published, so we cannot be certain that we are not infringing third parties' patent rights or that we were the first to conceive inventions covered by our patents or patent applications. As we become more visible as a publicly traded company, the possibility that third parties may make claims of intellectual property infringement or other violations against us may grow. An adverse outcome with respect to any such claim could invalidate our proprietary rights and force us to do one or more of the following:

- obtain from a third party claiming infringement a license to sell or use the relevant technology, which may not be available on reasonable terms, or at all;
- stop manufacturing, selling, incorporating or using our products that embody the asserted intellectual property;
- pay substantial monetary damages;
- indemnify our customers pursuant to indemnification obligations under some of our customer contracts; or
- expend significant resources to redesign the products that use the infringing technology and to develop or acquire non-infringing technology.

Any of these actions could result in a substantial reduction in our revenue and could result in losses over an extended period of time.

Our failure to obtain the right to use necessary third-party intellectual property rights on reasonable terms, or our failure to maintain, and comply with the terms and conditions applicable to, these rights, could harm our business and prospects.

From time to time we have licensed, and in the future we may choose to or be required to license, technology or intellectual property from third parties in connection with the development of our products. We cannot assure that such licenses will be available to us on commercially reasonable terms, or at all, and our inability to obtain such licenses could require us to substitute technology of lower quality or of greater cost. In addition, we incorporate open source software code in our proprietary software. Use of open source software can lead to greater risks than use of third-party commercial software since open source licensors generally do not provide warranties or controls with respect to origin, functionality or other features of the software. Some open source software licenses require users who distribute open source software as part of their products to publicly disclose all or part of the source code in their software and make any derivative works of the open source code available for limited fees or at no cost. Although we monitor our use of open source software, open source license terms may be ambiguous, and many of the risks associated with the use of open source software cannot be eliminated. If we were found to have inappropriately used open source software, we may be required to release our proprietary source code, re-engineer our software, discontinue the sale of certain products in the event re-engineering cannot be accomplished on a timely basis or take other remedial action. Furthermore, if we are unable to obtain or maintain licenses from third parties or fail to comply with applicable open source licenses, we may be subject to costly third party claims of intellectual property infringement or ownership of our proprietary source code. Any of the foregoing could harm our business and put us at a competitive disadvantage.

Defects and poor performance in our products could result in loss of customers, decreased revenue and unexpected expenses, and we may face warranty, indemnity and product liability claims arising from defective products.

Our products must meet stringent quality requirements and may contain undetected errors or defects, especially when first introduced or when new generations are released. Errors, defects or poor performance can arise due to

[Table of Contents](#)

design flaws, defects in raw materials or components or manufacturing difficulties, which can affect both the quality and the yield of the product. These errors or defects may be dangerous, as defective power components may cause power overloads, potentially resulting in explosion or fire. As we develop new generations of our products and enter new markets, we face higher risk of undetected defects, because our testing protocols may not be able to fully test the products under all possible operating conditions. In the past, we have experienced defects in our products due to certain errors in the manufacturing and design process. Any actual or perceived errors, defects or poor performance in our products could result in the replacement or recall of our products, shipment delays, rejection of our products, damage to our reputation, lost revenue, diversion of our engineering personnel from our product development efforts in order to address or remedy any defects and increases in customer service and support costs, all of which could have a material adverse effect on our business and operations.

Furthermore, defective, inefficient or poorly performing power components may give rise to warranty, indemnity or product liability claims against us that exceed any revenue or profit we receive from the affected products. We could incur significant costs and liabilities if we are sued and if damages are awarded against us. We currently maintain a moderate level of product liability insurance, and there can be no assurance that this insurance will provide sufficient coverage in the event of a claim. Also, we cannot predict whether we will be able to maintain this coverage on acceptable terms, if at all, or that a product liability claim would not harm our business or financial condition. Costs or payments we may make in connection with warranty and product liability claims or product recalls may adversely affect our financial condition and results of operations.

Our Enlighten web-based monitoring service, which our customers use to track and monitor the performance of their solar PV systems based on our product platform, may contain undetected errors, failures, or bugs, especially when new versions or enhancements are released. We have from time to time found defects in our service and new errors in our existing service may be detected in the future. Any errors, defects, disruptions in service or other performance problems with our monitoring service could harm our reputation and may damage our customers' businesses.

Our business has been and could continue to be affected by seasonal trends and construction cycles.

We have been and could continue to be subject to industry-specific seasonal fluctuations in the future, particularly in climates that experience colder weather during the winter months, such as northern Europe, Canada, and the United States. In general, we expect our product revenue in the third and fourth quarters to be positively affected by seasonal customer demand trends, including solar economic incentives, weather patterns and construction cycles. In the United States, customers will sometimes make purchasing decisions towards the end of the year in order to take advantage of tax credits or for budgetary reasons. In addition, construction levels are typically slower in colder months. In European countries with FiTs, the construction of solar PV systems may be concentrated during the second half of the calendar year, largely due to the annual reduction of the applicable minimum FiT and the fact that the coldest winter months are January through March. Accordingly, our business and quarterly results of operations could be affected by seasonal fluctuations in the future.

Covenants in our credit facilities may limit our flexibility in responding to business opportunities and competitive developments and increase our vulnerability to adverse economic or industry conditions.

We have lending arrangements with several financial institutions, including loan and security agreements with Comerica Bank and Bridge Bank, National Association, with Horizon Technology Finance Corporation, and with Hercules Technology Growth Capital, Inc., as well as a junior convertible loan facility with certain of our existing preferred shareholders. The loan and security agreements with Comerica Bank and Bridge Bank, with Horizon Technology Finance, with Hercules, and with the lenders under our junior convertible loan facility, all restrict our ability to take certain actions such as incurring additional debt, encumbering our tangible or intangible property, paying dividends, or engaging in certain transactions, such as mergers and acquisitions, investments and asset sales. Our loan and security agreement with Bridge Bank and Comerica Bank also requires us to maintain certain financial covenants, including liquidity and tangible net worth ratios. These restrictions may limit our

[Table of Contents](#)

flexibility in responding to business opportunities, competitive developments and adverse economic or industry conditions. In addition, our obligations under our loan and security agreements with Bridge Bank and Comerica Bank, Horizon Technology Finance, as well as for our junior convertible loan facility, are secured by substantially all of our assets (excluding intellectual property), which limits our ability to provide collateral for additional financing. A breach of any of these covenants, or a failure to pay interest or indebtedness when due under any of our credit facilities, could result in a variety of adverse consequences, including the acceleration of our indebtedness and the forfeiture of our assets subject to security interests in favor of the lenders.

If we fail to maintain an effective system of internal controls or are unable to remediate any deficiencies in our internal controls, we might not be able to report our financial results accurately or prevent fraud; in that case, our stockholders could lose confidence in our financial reporting, which would harm our business and could negatively impact the price of our stock.

Effective internal controls are necessary for us to provide reliable financial reports and prevent fraud. In addition, Section 404 of the Sarbanes-Oxley Act of 2002, or the Sarbanes-Oxley Act, will require us and potentially our independent registered public accounting firm to evaluate and report on our internal control over financial reporting beginning with our Annual Report on Form 10-K for the year ending December 31, 2013. The process of implementing our internal controls and complying with Section 404 will be expensive and time consuming, and will require significant attention of management. We cannot be certain that these measures will ensure that we implement and maintain adequate controls over our financial processes and reporting in the future. Even if we conclude, and our independent registered public accounting firm concurs, that our internal control over financial reporting provides reasonable assurance regarding the reliability of financial reporting and the preparation of financial statements for external purposes in accordance with generally accepted accounting principles, because of its inherent limitations, internal control over financial reporting may not prevent or detect fraud or misstatements. Failure to implement required new or improved controls, or difficulties encountered in their implementation, could harm our results of operations or cause us to fail to meet our reporting obligations. If we or our independent registered public accounting firm discover a material weakness, the disclosure of that fact, even if quickly remedied, could reduce the market's confidence in our financial statements and harm our stock price. In addition, a delay in compliance with Section 404 could subject us to a variety of administrative sanctions, including SEC action, ineligibility for short form resale registration, the suspension or delisting of our common stock from the stock exchange on which it is listed and the inability of registered broker-dealers to make a market in our common stock, which would further reduce our stock price and could harm our business.

With respect to 2011, we and our independent registered public accounting firm identified a significant deficiency in our internal controls over financial reporting but this deficiency did not create a material weakness. The significant deficiency related to our need for continued improvements in the documentation of accounting policies and procedures and segregation of duties. We have made efforts to remediate this significant deficiency through hiring additional experienced accounting personnel and by realigning certain roles and responsibilities to improve segregation of duties. If significant deficiencies in our internal controls are not fully remediated or if additional significant deficiencies are identified, those significant deficiencies could lead to material weaknesses in the future, potentially causing us to fail to meet our future reporting obligations and the price of our common stock to decline.

Our ability to use net operating losses to reduce future tax payments may be limited by provisions of the Internal Revenue Code, and may be subject to further limitation as a result of future transactions.

Sections 382 and 383 of the Internal Revenue Code of 1986, as amended, contain rules that limit the ability of a company that undergoes an ownership change, which is generally any cumulative change in ownership of more than 50% of its stock over a three-year period, to utilize its net operating loss and tax credit carryforwards and certain built-in losses recognized in the years after the ownership change. These rules generally operate by focusing on ownership changes involving stockholders who directly or indirectly own 5% or more of the stock of a company and any change in ownership arising from a new issuance of stock by the company. Generally, if an ownership change occurs, the yearly taxable income limitation on the use of net operating loss and tax credit

[Table of Contents](#)

carryforwards is equal to the product of the applicable long-term tax exempt rate and the value of the company's stock immediately before the ownership change. As a result, we may be unable to offset our taxable income with net operating losses, or our tax liability with credits, before these losses and credits expire.

In addition, it is possible that future transactions (including issuances of new shares of our common stock and sales of shares of our common stock) will cause us to undergo one or more additional ownership changes. In that event, we generally would not be able to use our net operating losses from periods prior to this ownership change to offset future taxable income in excess of the annual limitations imposed by Sections 382 and 383 and those attributes that are already subject to limitations (as a result of our prior ownership changes) may be subject to more stringent limitations.

We will incur increased costs as a result of operating as a public company, and our management will be required to devote substantial time to new compliance initiatives.

As a public company, we will incur legal, accounting and other expenses that we did not incur as a private company. The Dodd-Frank Wall Street Reform and Consumer Protection Act, or the Dodd-Frank Act, the Sarbanes-Oxley Act and the rules implemented by the SEC and the NASDAQ Global Market impose significant regulatory requirements on public companies, including specific corporate governance practices. For example, the listing requirements of the NASDAQ Global Market require that we satisfy certain corporate governance requirements relating to independent directors, audit and compensation committees, distribution of annual and interim reports, stockholder meetings, stockholder approvals, solicitation of proxies, conflicts of interest, stockholder voting rights and codes of conduct. Our management and other personnel will need to devote a substantial amount of time to these compliance initiatives. Moreover, these rules and regulations will increase our legal and financial compliance costs and will make some activities more time-consuming and costly. For example, we expect these rules and regulations to make it more difficult and more expensive for us to obtain director and officer liability insurance, and we may be required to accept reduced policy limits and coverage or incur substantial additional costs to maintain the same or similar coverage. These rules and regulations could also make it more difficult for us to attract and retain qualified persons to serve on our board of directors, our board committees or as executive officers.

These rules and regulations also contain requirements that apply to manufacturers of products incorporating specified minerals. The Dodd-Frank Act requires public companies to report on their use of so-called conflict minerals originating from the Democratic Republic of Congo or its nine immediate neighbors. Certain minerals commonly used in semiconductors are on the list of conflict minerals, and additional minerals may be added to the list in the future. Compliance with these rules, which will require us to disclose our use of these minerals and to obtain an annual audit of our sourcing and the chain of custody of these minerals, will be time-consuming and costly.

We may not be able to raise additional capital to execute on our current or future business opportunities on favorable terms, if at all, or without dilution to our stockholders.

We believe that our existing cash and cash equivalents, excluding any proceeds from this offering, available credit facilities and cash flows from our operating activities, will be sufficient to meet our anticipated cash needs for at least the next 12 months. However, we expect that ultimately we may need to raise additional capital to execute on our current or future business strategies, including to:

- invest in our research and development efforts by hiring additional technical and other personnel;
- expand our operations into new product markets and new geographies;
- acquire complementary businesses, products, services or technologies; or
- otherwise pursue our strategic plans and respond to competitive pressures.

We do not know what forms of financing, if any, will be available to us for this planned expansion. If financing is not available on acceptable terms, if and when needed, our ability to fund our operations, expand our

[Table of Contents](#)

research and development, sales and marketing functions, develop and enhance our products, respond to unanticipated events, including unanticipated opportunities, or otherwise respond to competitive pressures would be significantly limited. In any such event, our business, financial condition and results of operations could be materially harmed, and we may be unable to continue our operations. Moreover, if we raise additional funds through the issuance of equity or convertible debt securities, the percentage ownership of our stockholders could be significantly diluted, and these newly issued securities may have rights, preferences or privileges senior to those of existing stockholders, including those acquiring shares in this offering.

Natural disasters, terrorist attacks or other catastrophic events could harm our operations.

Our worldwide operations could be subject to natural disasters and other business disruptions, which could harm our future revenue and financial condition and increase our costs and expenses. For example, our corporate headquarters in Petaluma, California is located near major earthquake fault lines. Further, a terrorist attack, including one aimed at energy or communications infrastructure suppliers, could hinder or delay the development and sale of our products. In the event that an earthquake, tsunami, typhoon, terrorist attack or other natural, manmade or technical catastrophe were to destroy any part of our facilities or those of our contract manufacturer, destroy or disrupt vital infrastructure systems or interrupt our operations for any extended period of time, our business, financial condition and results of operations would be materially adversely affected.

Changes in current or future laws or regulations or the imposition of new laws or regulations, or new interpretations thereof, by federal or state agencies or foreign governments could impair our ability to compete in international markets.

Changes in current laws or regulations applicable to us or the imposition of new laws and regulations in the United States or other jurisdictions in which we do business, such as Canada, France, Italy and China, could materially and adversely affect our business, financial condition and results of operations. In addition, changes in our products or changes in export and import laws and implementing regulations may create delays in the introduction of new products in international markets, prevent our customers from deploying our products internationally or, in some cases, prevent the export or import of our products to certain countries altogether. While we are not aware of any current or proposed export or import regulations which would materially restrict our ability to sell our products in countries such as Canada, France, Italy or China, any change in export or import regulations or related legislation, shift in approach to the enforcement or scope of existing regulations, or change in the countries, persons or technologies targeted by these regulations, could result in decreased use of our products by, or in our decreased ability to export or sell our products to, existing or potential customers with international operations. In such event, our business and results of operations could be adversely affected.

Risks Related to This Offering and Our Common Stock

An active, liquid and orderly market for our common stock may not develop or be sustained, the trading prices of our common stock may be volatile and you may be unable to sell your shares at or above the offering price.

There has not been a public trading market for shares of our common stock prior to this offering. An active trading market may not develop or be sustained after this offering, which could depress the market price of our common stock and affect your ability to sell your shares. The initial public offering price for the shares of common stock sold in this offering may not be indicative of the price at which our common stock will trade after this offering.

The market price of our common stock could be subject to wide fluctuations in response to, among other things, the risk factors described in this section of this prospectus, and other factors beyond our control, such as fluctuations in the valuation of companies perceived by investors to be comparable to us. Furthermore, the stock markets have experienced price and volume fluctuations that have affected and continue to affect the market prices of equity securities of many companies. These fluctuations often have been unrelated or disproportionate to the operating performance of those companies. These broad market and industry fluctuations, as well as general economic,

[Table of Contents](#)

political and market conditions, such as recessions, interest rate changes or international currency fluctuations, may negatively affect the market price of our common stock. In the past, many companies that have experienced volatility in the market price of their stock have been subject to securities class action litigation. We may become the target of this type of litigation in the future. Securities litigation against us could result in substantial costs and divert our management's attention from other business concerns, which could seriously harm our business.

Our financial results may vary significantly from quarter to quarter due to a number of factors, which may lead to volatility in our stock price.

Our quarterly revenue and results of operations have varied in the past and may continue to vary significantly from quarter to quarter. This variability may lead to volatility in our stock price as research analysts and investors respond to these quarterly fluctuations. These fluctuations are due to numerous factors, including:

- fluctuations in demand for our products;
- the timing, volume and product mix of sales of our products, which may have different average selling prices or profit margins;
- changes in our pricing and sales policies or the pricing and sales policies of our competitors;
- our ability to design, manufacture and deliver products to our customers in a timely and cost-effective manner and that meet customer requirements;
- our ability to manage our relationships with our contract manufacturers, customers and suppliers;
- quality control or yield problems in our manufacturing operations;
- the anticipation, announcement or introductions of new or enhanced products by our competitors and ourselves;
- reductions in the retail price of electricity;
- changes in laws, regulations and policies applicable to our business and products, particularly those relating to government incentives for solar energy applications;
- unanticipated increases in costs or expenses;
- the amount and timing of operating costs and capital expenditures related to the maintenance and expansion of our business operations;
- the impact of government-sponsored programs on our customers;
- our exposure to the credit risks of our customers, particularly in light of the fact that some of our customers are relatively new entrants to the solar market without long operating or credit histories;
- our ability to estimate future warranty obligations due to product failure rates;
- our ability to forecast our customer demand, manufacturing requirements and manage our inventory;
- fluctuations in our gross profit;
- our ability to predict our revenue and plan our expenses appropriately; and
- fluctuations in foreign currency exchange rates.

The foregoing factors are difficult to forecast, and these, as well as other factors, could materially and adversely affect our quarterly and annual results of operations. Any failure to adjust spending quickly enough to compensate for a revenue shortfall could magnify the adverse impact of this revenue shortfall on our results of operations. Moreover, our results of operations may not meet our announced guidance or the expectations of research analysts or investors, in which case the price of our common stock could decrease significantly. There can be no assurance that we will be able to successfully address these risks.

[Table of Contents](#)

If research analysts do not publish research about our business or if they issue unfavorable commentary or downgrade our common stock, our stock price and trading volume could decline.

The trading market for our common stock will depend in part on the research and reports that research analysts publish about us and our business. The price of our common stock could decline if one or more research analysts downgrade our stock or if those analysts issue other unfavorable commentary or cease publishing reports about us or our business. If one or more of the research analysts ceases coverage of our company or fails to publish reports on us regularly, demand for our common stock could decrease, which could cause our stock price or trading volume to decline.

Our principal stockholders, executive officers and directors own a significant percentage of our stock and will continue to have significant control of our management and affairs after the offering, and they may take actions that our stockholders may not view as beneficial.

Following the completion of this offering, our executive officers, directors, greater than 5% stockholders, and entities that are affiliated with them, will beneficially own an aggregate of approximately 63.7% of our outstanding common stock, on an as-converted basis, assuming these persons and entities do not purchase any shares of our common stock in this offering. However, certain of our current stockholders have indicated an interest in purchasing an aggregate of \$15.0 million of shares of common stock in this offering, or 2,307,692 shares at the assumed initial public offering price of \$6.50 per share, the midpoint of the price range set forth on the cover page of this prospectus. If these current stockholders purchase all such shares of common stock in this offering, our executive officers, directors, greater than 5% stockholders, and entities that are affiliated with them would beneficially own shares representing approximately 69.2% of our common stock after this offering. This significant concentration of share ownership may adversely affect the trading price for our common stock because investors often perceive disadvantages in owning stock in companies with controlling stockholders. Also, as a result, these stockholders, acting together, may be able to control our management and affairs and matters requiring stockholder approval, including the election of directors and approval of significant corporate transactions, such as mergers, consolidations or the sale of substantially all of our assets. Consequently, this concentration of ownership may have the effect of delaying or preventing a change in control, including a merger, consolidation or other business combination involving us, or discouraging a potential acquirer from making a tender offer or otherwise attempting to obtain control, even if this change in control would benefit our other stockholders.

Our stock price could decline due to the large number of outstanding shares of our common stock eligible for future sale, which may dilute your voting power and your ownership interest in us.

Sales of substantial amounts of our common stock in the public market following this offering, or the perception that these sales could occur, could cause the market price of our common stock to decline. These sales could also make it more difficult for us to sell equity or equity-related securities in the future at a time and price that we deem appropriate.

Upon completion of this offering, as of December 31, 2011, we will have an aggregate of approximately 37,328,347 shares of common stock outstanding, assuming no exercise of the underwriters' over-allotment option, no exercise of outstanding options and no exercise of outstanding warrants. The 7,272,727 shares sold pursuant to this offering will be immediately tradable without restriction. Of the remaining shares:

- no shares will be eligible for sale immediately upon completion of this offering; and
- 30,055,620 shares, as of December 31, 2011, will be eligible for sale upon the expiration of lock-up agreements, subject in some cases to volume and other restrictions of Rule 144 and Rule 701 under the Securities Act of 1933, as amended, or the Securities Act.

The number of shares eligible for sale upon expiration of lock-up agreements assumes (1) the conversion of all outstanding shares of our preferred stock into an aggregate of 25,170,918 shares of common stock and (2) the automatic conversion of the outstanding principal amount of our junior secured convertible loan facility and paid-in-kind interest as of December 31, 2011 into 3,186,644 shares of common stock upon closing of this offering at a conversion price

[Table of Contents](#)

equal to \$6.50, assuming an initial public offering price of \$6.50 per share, the midpoint of the price range set forth on the cover page of this prospectus.

The lock-up agreements expire 180 days after the date of this prospectus, subject to potential extension in the event we release earning results or material news or a material event relating to us occurs near the end of the lock-up period. Morgan Stanley, as one of the representatives of the underwriters, may, in their sole discretion and at any time without notice, release all or any portion of the securities subject to lock-up agreements.

Based on shares of common stock and warrants outstanding on December 31, 2011, holders of approximately 29,747,889 shares and 293,474 shares of common stock issuable upon the exercise of outstanding warrants, representing 80% of our common stock, will have rights, subject to some conditions, to require us to file registration statements covering the sale of their shares or to include their shares in registration statements that we may file for ourselves or other stockholders. After the completion of this offering, we also intend to register approximately 3,312,774 shares of our common stock that have been issued or reserved for future issuance under our stock incentive plans. Once we register the offer and sale of shares for the holders of registration rights and option holders, they can be freely sold in the public market upon issuance, subject to the lock-up agreements or unless they are held by "affiliates," as that term is defined in Rule 144 of the Securities Act.

We may also issue shares of our common stock or securities convertible into our common stock from time to time in connection with a financing, acquisition, investments or otherwise. Any such issuance could result in substantial dilution to our existing stockholders and cause the trading price of our common stock to decline.

Participation in this offering by certain existing stockholders would reduce the available public float for our shares.

Entities affiliated with Third Point, Madrone, KPCB Holdings and Bay Partners have indicated an interest in purchasing up to an aggregate of \$15.0 million of shares of our common stock in this offering at the price offered to the public, or an aggregate of 2,307,692 shares based on an initial public offering price of \$6.50 per share, the midpoint of the price range set forth on the cover page of this prospectus. As of March 1, 2012, each of Third Point, Madrone, KPCB and Bay Partners beneficially owned more than 5% of our common stock and each is affiliated with a member of our board of directors. If these entities purchase all of these shares, the number of shares beneficially owned by each such stockholder after this offering, and the percentage of our common stock beneficially owned by each such stockholder after this offering, will increase. In addition, if these entities purchase all of these shares, the number of shares beneficially owned by all of our executive officers, directors and stockholders who beneficially owned more than 5% of our outstanding common stock after this offering as a group after this offering will be 28,428,587, and the percentage of common stock beneficially owned by this group after this offering will be approximately 69.2%.

If such existing stockholders purchase all or a portion of the shares in which they have indicated an interest in purchasing in this offering, such purchases would reduce the available public float for our shares because these entities would be restricted from selling the shares pursuant to lock-up agreements they have entered into with the underwriters in this offering and pursuant to restrictions under applicable securities laws. As a result, any purchase of shares by such existing stockholders in this offering would reduce the liquidity of our common stock relative to what it would have been had these shares been purchased by investors that were not affiliated with us.

Because our initial public offering price is substantially higher than the pro forma as adjusted net tangible book value per share of our outstanding common stock, new investors will incur immediate and substantial dilution.

The initial public offering price is substantially higher than the pro forma as adjusted net tangible book value per share of our common stock based on the expected total value of our total assets, less our intangible assets, less our total liabilities immediately following this offering. Therefore, if you purchase shares of our common stock in this offering, you will experience immediate and substantial dilution of \$4.54 per share in the

[Table of Contents](#)

price you pay for our common stock based on the assumed initial public offering price of \$6.50 per share, the midpoint of the price range set forth on the front cover of this prospectus, as compared to the pro forma as adjusted net tangible book value as of December 31, 2011. Furthermore, investors purchasing our common stock in this offering will own only 19% of our shares outstanding even though they will have contributed 29% of the total consideration received by us in connection with our sales of common stock. To the extent outstanding options and warrants to purchase common stock are exercised, there will be further dilution. For a further description of the dilution that you will experience immediately after this offering, see the section titled "Dilution."

Our management has broad discretion in the use of the net proceeds from this offering and may not use the net proceeds in ways that increase the value of your investment.

Our management will have broad discretion in the application of the net proceeds of this offering, and you will be relying on the judgment of our management regarding the application of these proceeds. We cannot assure you that our management will apply the net proceeds from this offering in ways that increase the value of your investment. We have not allocated the net proceeds from this offering for any specific purpose and we cannot specify with certainty the uses to which we will apply the net proceeds we will receive from this offering. Until we use the net proceeds from this offering, we plan to invest them, and these investments may not yield a favorable rate of return. If we do not invest or apply the net proceeds from this offering in ways that enhance stockholder value, we may fail to achieve expected financial results, which could cause our stock price to decline.

We currently do not intend to pay dividends on our common stock and, consequently, your only opportunity to achieve a return on your investment is if the price of our common stock appreciates.

We currently do not plan to declare dividends on shares of our common stock in the foreseeable future. In addition, the terms of our bank loan agreements restrict our ability to pay dividends. See "Dividend Policy" for more information. Consequently, your only opportunity to achieve a return on your investment in our company will be if the market price of our common stock appreciates and you sell your shares at a profit. There is no guarantee that the price of our common stock that will prevail in the market after this offering will ever exceed the price that you pay.

Our charter documents and Delaware law could prevent a takeover that stockholders consider favorable and could also reduce the market price of our stock.

Our certificate of incorporation and our bylaws that will be in effect upon the closing of this offering contain provisions that could delay or prevent a change in control of our company. These provisions could also make it more difficult for stockholders to elect directors and take other corporate actions, including effecting changes in our management. These provisions include:

- providing for a classified board of directors with staggered, three-year terms, which could delay the ability of stockholders to change the membership of a majority of our board of directors;
- not providing for cumulative voting in the election of directors, which limits the ability of minority stockholders to elect directory candidates;
- authorizing our board of directors to issue, without stockholder approval, preferred stock rights senior to those of common stock, which could be used to significantly dilute the ownership of a hostile acquiror;
- prohibiting stockholder action by written consent, which forces stockholder action to be taken at an annual or special meeting of our stockholders;
- requiring the affirmative vote of holders of at least 66 2/3% of the voting power of all of the then outstanding shares of voting stock, voting as a single class, to amend provisions of our certificate of incorporation relating to the management of our business, our board of directors, stockholder action by written consent, advance notification of stockholder nominations and proposals, forum selection and

Table of Contents

the liability of our directors, or to amend our bylaws, which may inhibit the ability of stockholders or an acquiror to effect such amendments to facilitate changes in management or an unsolicited takeover attempt;

- requiring special meetings of stockholders may only be called by our chairman of the board, our chief executive officer or a majority of our board of directors, which could delay the ability of our stockholders to force consideration of a proposal or to take action, including the removal of directors; and
- requiring advance notification of stockholder nominations and proposals, which may discourage or deter a potential acquiror from conducting a solicitation of proxies to elect the acquiror's own slate of directors or otherwise attempting to obtain control of us.

In addition, the provisions of Section 203 of the Delaware General Corporate Law will govern us upon completion of this offering. These provisions may prohibit large stockholders, in particular those owning 15% or more of our outstanding common stock, from engaging in certain business combinations without approval of substantially all of our stockholders for a certain period of time.

These provisions in our certificate of incorporation, our bylaws and under Delaware law could discourage potential takeover attempts, reduce the price that investors might be willing to pay for shares of our common stock in the future and result in the market price being lower than it would be without these provisions. See "Description of Capital Stock—Preferred Stock" and "Description of Capital Stock—Anti-Takeover Effects of Delaware Law and our Charter Documents."

SPECIAL NOTE REGARDING FORWARD-LOOKING STATEMENTS AND INDUSTRY DATA

This prospectus contains forward-looking statements that are based on our management's beliefs and assumptions and on information currently available to our management. The forward-looking statements are contained principally in the sections entitled "Prospectus Summary," "Risk Factors," "Management's Discussion and Analysis of Financial Condition and Results of Operations," "Business" and "Compensation Discussion and Analysis." Forward-looking statements include information concerning our possible or assumed future results of operations, business strategies, technology developments, financing and investment plans, competitive position, industry and regulatory environment, potential growth opportunities and the effects of competition. Forward-looking statements include statements that are not historical facts and can be identified by terms such as "anticipates," "believes," "could," "seeks," "estimates," "expects," "intends," "may," "plans," "potential," "predicts," "projects," "should," "will," "would" or similar expressions and the negatives of those terms.

Forward-looking statements involve known and unknown risks, uncertainties and other factors that may cause our actual results, performance or achievements to be materially different from any future results, performance or achievements expressed or implied by the forward-looking statements. Given these uncertainties, you should not place undue reliance on these forward-looking statements. Also, forward-looking statements represent our management's beliefs and assumptions only as of the date of this prospectus. You should read this prospectus and the documents that we have filed as exhibits to the registration statement, of which this prospectus is a part, completely and with the understanding that our actual future results may be materially different from what we expect.

Important factors that could cause actual results to differ materially from our expectations are disclosed under "Risk Factors" and elsewhere in this prospectus, including, without limitation, in conjunction with the forward-looking statements appearing elsewhere in this prospectus. Some of the factors that we believe could affect our results include:

- our history of losses, which may continue in the future;
- our limited operating history, which makes it difficult to predict future results;
- the future demand for solar energy solutions;
- the reduction, elimination or expiration of government subsidies and economic incentives for on-grid solar electricity applications;
- our ability to achieve broad market acceptance of our microinverter systems;
- changes in the retail price of electricity derived from the utility grid or alternative energy sources;
- our ability to develop new and enhanced products in response to customer demands and rapid market and technological changes in the solar industry;
- the success of competing solar solutions that are or become available;
- our ability to effectively manage the growth of our organization and expansion into new markets;
- our ability to maintain or achieve anticipated product quality, product performance and cost metrics;
- our inability to accurately estimate future warranty expense;
- competition and other factors that may cause potential future price reductions for our products;
- our ability to optimally match production with demand;
- our dependence on a limited number of outside contract manufacturers and lack of supply contracts with these manufacturers;
- general economic conditions in our domestic and international markets;

[Table of Contents](#)

- our ability to retain key personnel and attract additional qualified personnel;
- our ability to protect and defend our intellectual property; and
- the other factors set forth under “Risk Factors.”

Except as required by law, we assume no obligation to update these forward-looking statements, or to update the reasons actual results could differ materially from those anticipated in these forward-looking statements, even if new information becomes available in the future.

This prospectus also contains estimates and other information concerning our industry, including market size and growth rates, that are based on industry publications, surveys and forecasts, including those generated by the California Solar Initiative (CSI), the Solar Energy Industries Association (SEIA), IMS Research, the Datamonitor Group (Datamonitor), and IHS, Inc. (IHS iSuppli). Reports generated by IMS Research are “The World Market for Photovoltaic Inverters—2011 Edition” and “Preliminary PV Inverter Quarterly Market Tracker Report—4Q11.” This information involves a number of assumptions and limitations. Although we believe the information in these industry publications, surveys and forecasts is reliable, we have not independently verified the accuracy or completeness of the information. The industry in which we operate is subject to a high degree of uncertainty and risk due to variety of factors, including those described in “Risk Factors.” These and other factors could cause actual results to differ materially from those expressed in these publications, surveys and forecasts. This prospectus also contains product comparison data generated by Westinghouse Solar, a large solar installer that deploys our microinverter solution along with other inverter products. Although we believe the data generated by Westinghouse Solar is reliable, we have not independently verified the accuracy or completeness of the information.

USE OF PROCEEDS

We estimate that the net proceeds from our sale of shares of 7,272,727 common stock in this offering at an assumed initial public offering price of \$6.50 per share, the midpoint of the price range set forth on the front cover of this prospectus, after deducting estimated underwriting discounts and commissions and estimated offering expenses, will be approximately \$40.2 million, or \$46.8 million if the underwriters' option to purchase additional shares is exercised in full. A \$1.00 increase (decrease) in the assumed initial public offering price would increase (decrease) the net proceeds to us from this offering by \$6.8 million, assuming the number of shares offered by us, as set forth on the cover page of this prospectus, remains the same and after deducting the estimated underwriting discounts and commissions.

The principal reasons for this offering are to increase our capitalization and financial flexibility, increase our visibility in the marketplace and create a public market for our common stock. As of the date of this prospectus, we have no current specific plans for the use for the net proceeds of this offering, or a significant portion thereof. We currently intend to use the net proceeds of this offering primarily for general corporate purposes. Overall, our management will have broad discretion in the application of our net proceeds from this offering, and investors will be relying on the judgment of our management regarding the application of these proceeds. Pending their use, we plan to invest the net proceeds from this offering in short term, interest bearing obligations, investment grade instruments, certificates of deposit or direct or guaranteed obligations of the U.S. government.

DIVIDEND POLICY

We have never declared or paid dividends on our common stock and do not expect to pay dividends on our common stock for the foreseeable future. Instead, we anticipate that all of our earnings in the foreseeable future will be used for the operation and growth of our business. Any future determination to pay dividends on our common stock would be subject to the discretion of our board of directors and would depend upon various factors, including our results of operations, financial condition, liquidity requirements, restrictions that may be imposed by applicable law and our agreements and other factors deemed relevant by our board of directors. Our loan and security agreements with Horizon Technology Finance Corporation, Hercules Technology Growth Capital, Inc., Bridge Bank, National Association and Comerica Bank, as well as with the lenders under our junior convertible loan facility, all prohibit the payment of dividends.

CAPITALIZATION

The following table sets forth our consolidated capitalization as of December 31, 2011 on:

- an actual basis;
- on a pro forma basis to reflect (1) the conversion of all outstanding shares of our preferred stock into 25,170,918 shares of common stock, (2) the automatic conversion of the outstanding principal amount of our junior secured convertible loan facility and paid-in-kind interest as of December 31, 2011 into 3,186,644 shares of common stock upon closing of this offering at a conversion price equal to \$6.50, the midpoint of the price range set forth on the cover page of this prospectus, (3) the reclassification of our convertible preferred stock warrant liability to additional paid-in capital immediately prior to the completion of this offering, and (4) the write-off of debt issuance costs and debt discounts of \$2,994,000 to accumulated deficit, as a result of the closing of this offering.
- on a pro forma as adjusted basis to reflect (1) the pro forma adjustment described above, (2) the sale of 7,272,727 shares of common stock in this offering at an assumed initial public offering price of \$6.50 per share, the midpoint of the price range reflected on the front cover of this prospectus, after deducting estimated underwriting discounts and commissions and estimated offering expenses payable by us and (3) the filing of our amended and restated certificate of incorporation in connection with this offering.

Because the number of shares that will be issued upon conversion of our junior secured convertible loan facility depends upon the actual initial public offering price per share in this offering and the closing date of this offering, the actual number of shares issuable upon such conversion may differ from the number of shares set forth above. See “Prospectus Summary – The Offering.”

You should read this table together with “Management’s Discussion and Analysis of Financial Condition and Results of Operations” and our audited and unaudited consolidated financial statements and the related notes, each appearing elsewhere in this prospectus.

	As of December 31, 2011		
	Actual	Pro Forma	Pro Forma As Adjusted ⁽¹⁾
	(in thousands, except par value)		
Term loans	\$ 14,677	\$ 14,677	\$ 14,677
Convertible notes ⁽²⁾	19,202	—	—
Convertible preferred stock warrant liability	1,399	—	—
Stockholders’ equity:			
Convertible preferred stock, \$0.00001 par value, 23,559 shares authorized, 22,221 shares issued and outstanding actual; no shares authorized, issued and outstanding pro forma and pro forma as adjusted	93,596	—	—
Preferred stock, \$0.00001 par value, no shares authorized, issued and outstanding actual; 10,000 shares authorized, no shares issued and outstanding pro forma and pro forma as adjusted	—	—	—
Common stock, \$0.00001 par value; 41,410 shares authorized, 1,698 shares issued and outstanding actual; 41,410 shares authorized, 30,057 issued and outstanding pro forma; and 100,000 shares authorized, 37,328 shares issued and outstanding pro forma as adjusted	—	—	—
Additional paid-in capital	9,103	124,811	165,025
Accumulated deficit	(88,808)	(91,802)	(91,802)
Accumulated other comprehensive income	83	83	83
Total stockholders’ equity	13,974	33,092	73,306
Total capitalization	<u>\$ 49,252</u>	<u>\$ 47,769</u>	<u>\$ 87,983</u>

Table of Contents

-
- (1) A \$1.00 increase (decrease) in the assumed initial public offering price would result in an approximately \$6.8 million increase (decrease) in each of pro forma as adjusted additional paid-in capital, total stockholders' equity and total capitalization. If the underwriters exercise their over-allotment option in full, there would be a \$6.6 million increase in each of pro forma as adjusted additional paid-in capital, total stockholders' equity and total capitalization.
 - (2) The convertible notes mature upon the closing of this offering, at which time each note will automatically convert into our common stock at a conversion price of \$6.50, assuming an initial public offering price of \$6.50 per share, the midpoint of the price range set forth on the cover page of this prospectus.

The number of shares of common stock shown as issued and outstanding in the above table excludes:

- 357,459 shares of common stock issuable upon exercise of outstanding warrants, as of December 31, 2011, with a weighted-average exercise price of \$5.86 per share;
- 6,255,867 shares of common stock issuable upon the exercise of outstanding stock options under our 2006 Equity Incentive Plan, as of December 31, 2011, with a weighted-average exercise price of \$1.83 per share;
- 2,643,171 shares of common stock reserved for future issuance under our 2011 Equity Incentive Plan, which will become effective prior to the completion of this offering and contains provisions that will automatically increase its share reserve each year, as more fully described in "Executive Compensation—Employee Benefit Plans"; and
- 669,603 shares of common stock reserved for future issuance under our 2011 Employee Stock Purchase Plan, which will become effective prior to the completion of this offering and contains provisions that will automatically increase its share reserve each year, as more fully described in "Executive Compensation—Employee Benefit Plans".

DILUTION

If you invest in our common stock, your interest will be diluted to the extent of the difference between the amount per share paid by purchasers of shares of our common stock in this initial public offering and the pro forma as adjusted net tangible book value per share of our common stock immediately after completion of this offering.

At December 31, 2011, we had net tangible book value of \$13.7 million. Net tangible book value represents the amount of our net assets of \$14.0 million less our intangible assets of \$0.3 million. At December 31, 2011, our pro forma net tangible book value was \$32.8 million (pro forma net assets of \$33.1 million less pro forma intangible assets of \$0.3 million) or \$1.09 per share of common stock. Pro forma net tangible book value per share represents the amount of our net tangible book value increased by the amount of our convertible preferred stock warrant liability and divided by the pro forma shares of common stock outstanding at December 31, 2011, assuming (1) the automatic conversion of all outstanding shares of our preferred stock into an aggregate of 25,170,918 shares of common stock, (2) the automatic conversion of the outstanding principal amount of our junior secured convertible loan facility and paid-in-kind interest as of December 31, 2011 into 3,186,644 shares of common stock upon closing of this offering at a conversion price equal to \$6.50, assuming an initial public offering price of \$6.50 per share, the midpoint of the price range set forth on the cover page of this prospectus, and (3) the conversion of warrants to purchase 198,256 shares of preferred stock into warrants to purchase 214,930 shares of common stock in connection with this offering.

Because the number of shares that will be issued upon conversion of our junior secured convertible loan facility depends upon the actual initial public offering price per share in this offering and the closing date of this offering, the actual number of shares issuable upon such conversion may differ from the number of shares set forth above. See “Prospectus Summary—The Offering.”

After giving effect to our sale of 7,272,727 shares of common stock in this offering at an assumed initial public offering price of \$6.50 per share, the midpoint of the price range set forth on the front cover of this prospectus, and after deducting estimated underwriting discounts and commissions and estimated offering expenses, our pro forma as adjusted net tangible book value at December 31, 2011 would have been \$73.0 million, or \$1.96 per share of common stock. This represents an immediate increase in pro forma net tangible book value of \$0.87 per share to existing stockholders and an immediate dilution of \$4.54 per share to new investors.

The following table illustrates this dilution:

Assumed initial public offering price per share		\$6.50
Pro forma net tangible book value per share as of December 31, 2011 before giving effect to this offering	\$1.09	
Increase in pro forma net tangible book value per share attributable to new investors purchasing shares in this offering	<u>0.87</u>	
Pro forma as adjusted net tangible book value per share after this offering		<u>1.96</u>
Dilution per share to new investors in this offering		<u>\$4.54</u>

[Table of Contents](#)

The following table summarizes, on a pro forma as adjusted basis as of December 31, 2011, the total number of shares of common stock purchased from us, the total consideration paid to us and the average price per share paid to us by existing stockholders and by new investors purchasing shares in this offering at the assumed initial public offering price of \$6.50 per share, the midpoint of the price range set forth on the front cover of this prospectus, before deducting estimated underwriting discounts and commissions and estimated offering expenses:

	<u>Shares Purchased</u>		<u>Total Consideration</u>		<u>Average Price Per Share</u>
	<u>Number</u>	<u>Percent</u>	<u>Amount</u>	<u>Percent</u>	
Existing stockholders	30,055,620	81%	\$116,145,392	71%	\$ 3.86
New investors	7,272,727	19%	47,272,726	29%	6.50
Total	37,328,347	100%	\$163,418,118	100%	

A \$1.00 increase or decrease in the assumed initial public offering price would increase or decrease, as applicable, total consideration paid to us by new investors and total consideration paid to us by all stockholders by approximately \$6.8 million, assuming the number of shares offered by us remains the same as set forth on the cover page of this prospectus and without deducting the estimated underwriting discounts and commissions and estimated offering expenses that we must pay.

The foregoing dilution calculations exclude:

- 357,459 shares of common stock issuable upon exercise of outstanding warrants, as of December 31, 2011, with a weighted-average exercise price of \$5.86 per share;
- 6,255,867 shares of common stock issuable upon the exercise of outstanding stock options under our 2006 Equity Incentive Plan, as of December 31, 2011, with a weighted-average exercise price of \$1.83 per share;
- 2,643,171 shares of common stock reserved for future issuance under our 2011 Equity Incentive Plan, which will become effective prior to the completion of this offering and contains provisions that will automatically increase its share reserve each year, as more fully described in “Executive Compensation—Employee Benefit Plans”; and
- 669,603 shares of common stock reserved for future issuance under our 2011 Employee Stock Purchase Plan, which will become effective prior to the completion of this offering and contains provisions that will automatically increase its share reserve each year, as more fully described in “Executive Compensation—Employee Benefit Plans”.

To the extent that any outstanding options or warrants are exercised, there will be further dilution to new investors.

SELECTED CONSOLIDATED FINANCIAL DATA

The selected consolidated statement of operations data for each of the years ended December 2009, 2010 and 2011 and the selected consolidated balance sheet data as of December 31, 2010 and 2011 are derived from our audited consolidated financial statements included elsewhere in this prospectus. The selected consolidated statement of operations data for the year ended December 31, 2008 and the selected consolidated balance sheet data as of December 31, 2008 and 2009 are derived from our audited financial statements not included in this prospectus. The selected balance sheet data and the selected statement of operations data as of and for the year ended December 31, 2007 are derived from our unaudited consolidated financial statements not included in this prospectus. Our historical results are not indicative of the results to be expected in any future period. You should read these selected financial data in conjunction with “Management’s Discussion and Analysis of Financial Condition and Results of Operations” and our financial statements and the related notes included elsewhere in this prospectus.

	Year Ended December 31,				
	2007	2008	2009	2010	2011
	(in thousands, except per share data)				
Consolidated Statement of Operations Data:					
Net revenues	\$ —	\$ 1,668	\$ 20,194	\$ 61,661	\$ 149,523
Cost of revenues ⁽¹⁾	—	7,475	23,223	55,159	120,454
Gross profit (loss)	—	(5,807)	(3,029)	6,502	29,069
Operating expenses:					
Research and development ⁽¹⁾	2,068	5,354	8,411	14,296	25,099
Sales and marketing ⁽¹⁾	458	1,809	2,651	6,558	17,454
General and administrative ⁽¹⁾	742	1,727	2,603	6,365	15,228
Total operating expenses	3,268	8,890	13,665	27,219	57,781
Loss from operations	(3,268)	(14,697)	(16,694)	(20,717)	(28,712)
Other income (expense), net:					
Interest income	179	206	125	39	4
Interest expense	—	(9)	(356)	(914)	(3,006)
Other income (expense)	—	(1)	—	(185)	(576)
Total other income (expense), net	179	196	(231)	(1,060)	(3,578)
Net loss attributable to common stockholders	\$ (3,089)	\$ (14,501)	\$ (16,925)	\$ (21,777)	\$ (32,290)
Net loss per share attributable to common stockholders, basic and diluted ⁽²⁾	\$ (9.22)	\$ (24.70)	\$ (25.92)	\$ (28.96)	\$ (25.73)
Shares used in computing net loss per share attributable to common stockholders, basic and diluted ⁽²⁾	335	587	653	752	1,255
Pro forma net loss per share attributable to common stockholders, basic and diluted ⁽²⁾					\$ (1.26)
Pro forma shares used in computing pro forma net loss per share attributable to common stockholders basic and diluted ⁽²⁾					27,657

[Table of Contents](#)

	As of December 31,				
	2007	2008	2009	2010	2011
	(in thousands)				
Consolidated Balance Sheet Data:					
Cash and cash equivalents	\$ 2,548	\$ 4,136	\$ 8,642	\$39,993	\$ 51,524
Working capital	2,322	2,521	11,004	39,753	29,417
Total assets	3,325	8,710	20,947	59,504	106,242
Term loans	—	571	411	6,903	14,677
Convertible notes	—	—	—	—	19,202
Convertible preferred stock	6,209	21,871	47,859	93,596	93,596
Common stock and additional paid-in capital	81	298	509	1,403	9,103
Total stockholders' equity	2,975	4,353	13,627	38,481	13,974

(1) Includes stock-based compensation expense as follows:

	Year Ended December 31,				
	2007	2008	2009	2010	2011
	(in thousands)				
Cost of revenues	\$—	\$ 4	\$ 17	\$ 9	\$ 39
Research and development	—	27	62	286	795
Sales and marketing	—	7	36	256	671
General and administrative	70	170	65	278	615
Total stock-based compensation expense	<u>\$70</u>	<u>\$208</u>	<u>\$180</u>	<u>\$829</u>	<u>\$2,120</u>

(2) See Note 14 to Consolidated Financial Statements for a description of how we compute basic and diluted net loss attributable to common stockholders, basic and diluted net loss per share attributable to common stockholders and pro forma basic and diluted net loss per share attributable to common stockholders.

MANAGEMENT'S DISCUSSION AND ANALYSIS OF FINANCIAL CONDITION AND RESULTS OF OPERATIONS

The following discussion and analysis of our financial condition and results of operations should be read in conjunction with the consolidated financial statements and related notes thereto included in this prospectus. In addition to historical information, this discussion and analysis contains forward-looking statements that involve risks, uncertainties and assumptions. Our actual results could differ materially from those discussed in the forward-looking statements. We discuss factors that we believe could cause or contribute to these differences below and elsewhere in this prospectus, particularly the "Special Note Regarding Forward-Looking Statements and Industry Data" and "Risk Factors" sections.

Overview

We deliver microinverter technology for the solar industry that increases energy production, simplifies design and installation, improves system uptime and reliability, reduces fire safety risk and provides a platform for intelligent energy management. We are the market leader in the microinverter category and have grown rapidly since our first commercial shipment in mid-2008, with over 1,550,000 microinverter units sold as of December 31, 2011, representing over an estimated 40,000 system installations. We were the first company to commercially ship microinverter systems in volume. Our products have been installed in all 50 U.S. states and eight Canadian provinces, and we are rapidly taking market share from traditional central inverter manufacturers.

We were founded in March 2006 and began generating revenue in June 2008. From inception to December 31, 2011, we have raised over \$115.2 million in net proceeds from the private placements of convertible preferred stock and convertible debt. The history of our product development and sales and marketing efforts is as follows:

- From inception to the second quarter of fiscal 2008, our efforts focused on developing a complete microinverter solution for the solar PV industry;
- In the second quarter of 2008, we began selling our first generation microinverter along with our Envoy communications gateway device and our Enlighten web-based monitoring service;
- In the first half of 2009, we focused on the development of our second generation microinverter and migrated our contract manufacturing to Flextronics, which provided us with access to commercial scale manufacturing and logistics services;
- In the third quarter of 2009, we began selling our second generation microinverter in volume;
- In 2010, we invested in our sales and marketing organization to increase market penetration, continued design innovations for our second generation microinverter, sold more than 400,000 units and commenced development of our third generation microinverter;
- In the second quarter of 2011, we began selling our third generation microinverter;
- In the fourth quarter of 2011, we began selling our products in France, Italy and the Benelux region; and
- During 2011, we sold more than 1,000,000 microinverters.

We sell our microinverter systems primarily to distributors who resell them to solar installers. Over 3,400 installers in North America have installed our microinverters through December 31, 2011, and this number is increasing by approximately 100 new installers per month. We also sell directly to large installers and through OEMs and strategic partners.

A substantial majority of our revenue has been generated by sales within the United States. Sales to customers in Canada commenced in 2009 and accounted for approximately 3%, 13% and 12% of our net

[Table of Contents](#)

revenues in 2009, 2010 and 2011, respectively. We anticipate that the majority of our 2012 revenues will continue to come from the United States, with the balance from Canada and Europe.

We have achieved substantial growth since we commenced commercial production in 2008. Our net revenues were \$20.2 million, \$61.7 million and \$149.5 million for the years ended December 31, 2009, 2010 and 2011, respectively. Net losses were \$16.9 million, \$21.8 million and \$32.3 million for the years ended December 31, 2009, 2010 and 2011, respectively. We expect to incur a net loss in 2012 and may continue to incur net losses in future years as we continue to invest substantial resources to support the growth of our business. However, over time, we believe the significant investments we are making to scale our business will allow us to achieve an increasingly efficient operating cost structure. We believe that this, combined with the differentiated value proposition of our microinverter solution including product cost reductions through further semiconductor integration, will allow us to improve our gross profit and reduce our operating expenses as a percentage of revenue.

Results of Operations

The following describes the line items in our Consolidated Statements of Operations.

Net Revenues

We generate revenue from sales of our microinverter systems, which include microinverter units, an Envoy communications gateway device, and our Enlighten web-based monitoring service. We sell to distributors, large installers, OEMs and strategic partners.

Our revenue is affected by changes in the volume and average selling prices of our microinverter systems, driven by supply and demand, sales incentives, and competitive product offerings. Our revenue growth is dependent on our ability to market our products in a manner that increases awareness for microinverter technology, the continual development and introduction of new products to meet the changing technology and performance requirements of our customers, and the diversification and expansion of our revenue base.

Cost of Revenues and Gross Profit

Cost of revenues is comprised primarily of product costs consisting of purchases from our contract manufacturers and other suppliers, warranty, personnel and logistics costs, depreciation and amortization of test equipment and hosting services costs. Our product costs are impacted by technological innovations, such as advances in semiconductor integration and new product introductions, economies of scale resulting in lower component costs, and improvements in production processes and automation. Certain of these costs, primarily personnel and depreciation and amortization of test equipment, are not directly affected by sales volume.

We outsource our manufacturing to third-party manufacturers and negotiate product pricing on a quarterly basis. In addition, a contract manufacturer also serves as our logistics provider by warehousing and delivering our products in the United States and Canada. We believe our contract manufacturing partners have sufficient production capacity to meet the growing demand for our products for the foreseeable future. However, shortages in the supply of certain key raw materials could adversely affect our ability to meet customer demand for our products.

Gross profit may vary from quarter to quarter and is primarily affected by our average selling prices, product costs, geographical mix and seasonality.

Operating Expenses

Operating expenses consist of research and development, sales and marketing and general and administrative expenses. Personnel-related costs are the most significant component of each of these expense

[Table of Contents](#)

categories and include salaries, benefits, payroll taxes, recruiting costs, commissions and stock-based compensation. Our full-time employee headcount has grown from 58 at December 31, 2008, to 79 at December 31, 2009, to 153 at December 31, 2010 and to 298 at December 31, 2011. We expect to continue to hire significant numbers of new employees to support our growth. The timing of these additional hires could materially affect our operating expenses, both in absolute dollars and as a percentage of revenue, in any particular period. We expect to continue to invest substantial resources to support the growth of our company globally and anticipate that each of the following categories of operating expenses will increase in absolute dollar amounts for the foreseeable future.

Research and development expense includes personnel-related expenses such as salaries, stock-based compensation and employee benefits. Our research and development employees are engaged in the design and development of power electronics, semiconductors, powerline communications and networking and software functionality. Our research and development expense also includes third-party design and development costs, testing and evaluation costs, depreciation expense and other indirect costs. We devote substantial resources in ongoing research and development programs that focus on enhancements to and cost efficiencies in our existing products and timely development of new products that utilize technological innovation to drive down products costs. We intend to continue to invest substantial resources in our research and development efforts because we believe they are essential to maintaining our competitive position. Investments in research and development personnel costs are expected to increase in total dollars for the foreseeable future.

Sales and marketing expense consists primarily of personnel-related expenses such as salaries, commissions, stock-based compensation, employee benefits, and travel. It also includes trade shows, marketing, customer support and other indirect costs. We expect our sales and marketing expense to increase in absolute dollars for the foreseeable future as we continue to increase the number of our sales and channel support personnel to enable us to increase our market penetration geographically and into new markets by expanding our customer base of distributors, large installers, OEMs and strategic partners. Historically, all of our sales have been in the United States and Canada. In the first quarter of 2011 we opened sales offices in Italy and France, and began selling into France, Italy and the Benelux region in the fourth quarter of 2011. We expect to continue to expand our geographic footprint in the future.

General and administrative expense consists primarily of salaries, stock-based compensation and employee benefits for personnel related to our executive, finance, human resources, information technology and legal organizations, facilities cost, and fees for professional services. Professional services consist of outside legal, accounting and information technology consulting costs. We expect that after this offering we will incur additional accounting and legal costs related to compliance with securities and other regulations, as well as additional insurance, investor relations and other costs associated with being a public company.

Other Income (Expense), Net

Other income (expense), net includes interest income on invested cash balances and interest expense on amounts outstanding under our credit and convertible note facilities and non-cash interest expense related to the amortization of debt discounts and deferred financing costs. Other income (expense), net also includes mark-to-market adjustments to record our preferred stock warrants at fair value, which were issued in conjunction with credit facilities, as well as losses or gains on conversion of non-U.S. dollar transactions into U.S. dollars.

Provision (Benefit) for Income Taxes

We are subject to income taxes in the countries where we sell our products. Historically, we have primarily been subject to taxation in the United States because we have sold the vast majority of our products to customers in the United States. We anticipate that in the future, as we expand our sale of products to customers outside the United States, we would become subject to taxation based on the foreign statutory rates in the countries where

[Table of Contents](#)

these sales took place and our effective tax rate could fluctuate accordingly. We have not recorded any United States federal or state income tax provision for any of the periods presented because we have experienced operating losses since inception. Due to the history of losses we have generated since inception, we have recorded a full valuation allowance on our deferred tax assets.

Summary Consolidated Statements of Operations

The following table sets forth a summary of our consolidated statements of operations for the periods presented (in thousands):

	Year Ended December 31,		
	2009	2010	2011
Net revenues	\$ 20,194	\$ 61,661	\$ 149,523
Cost of revenues	23,223	55,159	120,454
Gross profit (loss)	(3,029)	6,502	29,069
Operating expenses:			
Research and development	8,411	14,296	25,099
Sales and marketing	2,651	6,558	17,454
General and administrative	2,603	6,365	15,228
Total operating expenses	13,665	27,219	57,781
Loss from operations	(16,694)	(20,717)	(28,712)
Other income (expense), net	(231)	(1,060)	(3,578)
Net loss	\$ (16,925)	\$ (21,777)	\$ (32,290)

Comparison of 2009, 2010 and 2011

Net Revenues

	Year Ended December 31,			Change	
	2009	2010	2011	2009 to 2010	2010 to 2011
			(in thousands)		
Net revenues	\$20,194	\$61,661	\$149,523	\$ 41,467	\$ 87,862

Net revenues for 2011 increased by 142% compared to 2010 due primarily to the number of microinverter units sold, which increased by 142% from approximately 414,000 units in 2010 to approximately 1.0 million units in 2011. The increase in units sold was attributable to sales of our third generation microinverter, which was introduced during the second quarter of 2011. The overall increase in unit sales was driven by deeper penetration of our existing customer base, the addition of new customers, further expansion into Canada, and broader acceptance of our products resulting from, among other factors, investments made in sales and marketing. During 2011, we continued to experience a slight decline in the average selling price of our microinverters. If 2010 average selling prices of our microinverters had remained constant, net revenues for 2011 would have been higher by approximately \$5.3 million. The decline in average selling prices reflects, and is consistent with, recent market trends in the solar industry. We expect these trends to continue in the foreseeable future.

Net revenues for 2010 increased by 205% compared to 2009. The increase in net revenues was due to the number of microinverter units sold increasing by 229% from approximately 126,000 units in 2009 to approximately 414,000 units in 2010. The increase in units sold was driven by deeper penetration of our existing customer base, the addition of new customers, further expansion into Canada, and broader acceptance of our products resulting, among other factors, from investments made in sales and marketing. If 2009 average selling

[Table of Contents](#)

prices of our microinverters had remained constant, net revenues for 2010 would have been higher by approximately \$1.7 million. The decline in average selling prices reflects, and was consistent with market trends in the solar industry.

Cost of Revenues and Gross Profit (Loss)

	Year Ended December 31,			Change	
	2009	2010	2011	2009 to 2010	2010 to 2011
Cost of revenues	\$23,223	\$55,159	\$120,454	\$ 31,936	\$ 65,295
Gross profit (loss)	(3,029)	6,502	29,069	9,531	22,567

Cost of revenues for 2011 increased from 2010 primarily due to an increase in the number of microinverter units sold to customers, consistent with the overall increase in net revenues as described above. Gross profit as a percentage of revenue increased from 10.5% in 2010 to 19.4% in 2011. Substantially all of this increase in gross profit as a percentage of revenue was driven by a reduction in material cost per unit primarily resulting from the introduction of our third generation microinverter. Our 2011 gross profit as a percentage of net revenues was also positively impacted by a 2% decrease in raw materials costs over the comparable 2010 period, design enhancements resulting in a higher level of product integration and efficiency gains in the manufacturing process of our third generation microinverter.

Cost of revenues for 2010 increased from 2009 primarily due to an increase in the number of microinverter units sold to customers, consistent with the overall increase in net revenues as described above. Gross profit (loss) as a percentage of revenue increased from (15%) in 2009 to 10.5% in 2010. Prior to 2010, we had negative gross profit as our sales were insufficient to cover our product costs as well as personnel costs, which are not directly affected by sales volume. In 2010, we achieved economies of scale and positive gross profit as we ramped up production of our higher margin second generation product.

Research and Development

	Year Ended December 31,			Change	
	2009	2010	2011	2009 to 2010	2010 to 2011
Research and development	\$8,411	\$14,296	\$25,099	\$ 5,885	\$ 10,803

Research and development expenses increased by \$10.8 million in 2011 as compared to 2010, primarily due to a \$7.1 million increase in personnel-related costs as a result of increases in research and development headcount. The increase in headcount reflects our continuing investment in enhancements of existing products as well as efforts to bring new products to market, including our third generation microinverter. In addition, depreciation and amortization related to research and development and the use of outside services for the development of new products increased by \$2.2 million and \$1.4 million, respectively, as compared to the prior year period.

Research and development expenses increased from 2009 to 2010 primarily due to increases in research and development headcount. Salaries and related personnel expenses accounted for \$4.2 million of the \$5.9 million increase in research and development expenses. In addition, outsourced engineering fees and other outside services fees increased by approximately \$1.6 million related to the development of new features for our next generation of products. We plan to continue to invest in research and development as we develop new products and make further enhancements to existing products.

Sales and Marketing

	Year Ended December 31,			Change	
	2009	2010	2011	2009 to 2010	2010 to 2011
	(in thousands)				
Sales and marketing	\$2,651	\$6,558	\$17,454	\$ 3,907	\$ 10,896

Sales and marketing expenses increased by \$10.9 million in 2011 as compared to 2010, primarily due to increases in sales and marketing headcount to support higher sales volumes and international expansion. Personnel-related costs increased by \$8.1 million, which included a \$2.3 million increase due to additions in sales and marketing headcount for international locations in 2011 compared to 2010. In addition, costs related to trade shows, the use of outside services and other directly related overhead costs contributed an additional \$1.2 million, \$1.1 million and \$0.5 million, respectively, to the increase in fiscal 2011.

Sales and marketing expenses increased from 2009 to 2010 primarily due to increases in sales and marketing headcount. Salaries and related personnel expenses accounted for \$3.0 million of the \$3.9 million increase in sales and marketing expenses as a result of expansion of our sales organization in order to increase product awareness and expand our sales presence. We expect that sales and marketing expenses will continue to increase in absolute dollars as we expand sales operations domestically and internationally.

General and Administrative

	Year Ended December 31,			Change	
	2009	2010	2011	2009 to 2010	2010 to 2011
	(in thousands)				
General and administrative	\$2,603	\$6,365	\$15,228	\$ 3,762	\$ 8,863

General and administrative expenses increased by \$8.9 million in 2011 as compared to 2010, primarily due to a \$4.7 million increase in personnel-related costs as a result of increases in general and administrative headcount and a \$2.5 million increase in accounting, legal and other professional services incurred to assist us with building an infrastructure to support public company requirements. In addition, depreciation and amortization and facilities costs contributed \$1.7 million to the increase in 2011 compared to 2010 as a result of increased capital expenditures and facilities costs incurred to support our increased headcount and the expansion of our operations. We expect to incur additional expenses as a result of operating as a public company, including costs to comply with the Sarbanes-Oxley Act and the rules and regulations applicable to companies listed on the NASDAQ Stock Market.

General and administrative expenses increased from 2009 to 2010 due to increases in general and administrative headcount. Salaries and related personnel expenses accounted for \$2.3 million of the \$3.8 million increase in general and administrative expenses. Also, professional services fees increased \$690,000. The additional personnel and professional services fees are primarily the result of our on-going efforts to build the legal, finance, human resources, recruiting and information technology functions required of a public company. In addition, depreciation and amortization and facilities costs also contributed \$0.6 million to the increase in 2010 over 2009.

[Table of Contents](#)

Other Income (Expense), Net

	Year Ended December 31,			Change	
	2009	2010	2011	2009 to 2010	2010 to 2011
	(in thousands)				
Other income (expense), net	\$(231)	\$(1,060)	\$(3,578)	\$ (829)	\$(2,518)

Other expense increased by \$2.5 million in 2011 as compared to 2010. This increase was primarily due to an increase in interest expense from higher debt balances and non-cash interest charges. Non-cash interest charges totaled \$1.8 million and \$0.1 million for 2011 and 2010, respectively, and consisted of amortization of debt discounts as well as paid-in-kind interest on our convertible notes.

Other expense increased from 2009 to 2010 primarily due to interest expense related to increased borrowings in 2010.

Quarterly Results of Operations

The following table presents our unaudited quarterly results of operations for the 12 quarters in the period ended December 31, 2011. This unaudited quarterly information has been prepared on the same basis as our audited financial statements and includes all adjustments, consisting only of normal recurring adjustments, necessary for the fair presentation of the information for the quarters presented. You should read this information in conjunction with our audited consolidated financial statements and the related notes thereto. The results of operations for any quarter are not necessarily indicative of results of operations for any future period.

	Three Months Ended											
	Mar 31, 2009	Jun 30, 2009	Sep 30, 2009	Dec 31, 2009	Mar 31, 2010	Jun 30, 2010	Sep 30, 2010	Dec 31, 2010	Mar 31, 2011	Jun 30, 2011	Sep 30, 2011	Dec 31, 2011
	(in thousands)											
Net revenues	\$ 1,159	\$ 1,625	\$ 5,407	\$12,003	\$ 11,587	\$10,769	\$18,690	\$ 20,615	\$ 18,069	\$ 29,592	\$44,728	\$ 57,134
Costs of revenues	<u>2,672</u>	<u>3,725</u>	<u>5,681</u>	<u>11,145</u>	<u>10,631</u>	<u>9,464</u>	<u>16,650</u>	<u>18,414</u>	<u>15,421</u>	<u>24,785</u>	<u>36,185</u>	<u>44,063</u>
Gross profit	<u>(1,513)</u>	<u>(2,100)</u>	<u>(274)</u>	<u>858</u>	<u>956</u>	<u>1,305</u>	<u>2,040</u>	<u>2,201</u>	<u>2,648</u>	<u>4,807</u>	<u>8,543</u>	<u>13,071</u>
Operating expense:												
Research and development	1,752	2,061	2,249	2,349	2,735	3,160	3,968	4,433	5,345	6,143	6,431	7,180
Sales and marketing	513	489	661	988	855	1,280	1,954	2,468	3,010	4,265	4,567	5,612
General and administrative	534	482	533	1,054	1,099	1,387	1,900	1,979	3,250	3,889	3,980	4,109
Total operating expenses	<u>2,799</u>	<u>3,032</u>	<u>3,443</u>	<u>4,391</u>	<u>4,689</u>	<u>5,827</u>	<u>7,822</u>	<u>8,880</u>	<u>11,605</u>	<u>14,297</u>	<u>14,978</u>	<u>16,901</u>
Loss from operations	<u>(4,312)</u>	<u>(5,132)</u>	<u>(3,717)</u>	<u>(3,533)</u>	<u>(3,733)</u>	<u>(4,522)</u>	<u>(5,782)</u>	<u>(6,679)</u>	<u>(8,957)</u>	<u>(9,490)</u>	<u>(6,435)</u>	<u>(3,830)</u>
Other income (expense), net	<u>(9)</u>	<u>(250)</u>	<u>28</u>	<u>—</u>	<u>(66)</u>	<u>(329)</u>	<u>(322)</u>	<u>(342)</u>	<u>(332)</u>	<u>(798)</u>	<u>(741)</u>	<u>(1,707)</u>
Net loss	<u>\$ (4,321)</u>	<u>\$ (5,382)</u>	<u>\$ (3,689)</u>	<u>\$ (3,533)</u>	<u>\$ (3,799)</u>	<u>\$ (4,851)</u>	<u>\$ (6,104)</u>	<u>\$ (7,021)</u>	<u>\$ (9,289)</u>	<u>\$ (10,288)</u>	<u>\$ (7,176)</u>	<u>\$ (5,537)</u>

[Table of Contents](#)

The following table presents the unaudited quarterly results of operations as a percentage of revenue:

	Three Months Ended											
	Mar 31, 2009	Jun 30, 2009	Sep 30, 2009	Dec 31, 2009	Mar 31, 2010	Jun 30, 2010	Sep 30, 2010	Dec 31, 2010	Mar 31, 2011	Jun 30, 2011	Sep 30, 2011	Dec 30, 2011
Net revenues	100%	100%	100%	100%	100%	100%	100%	100%	100%	100%	100%	100%
Costs of revenues	231	229	105	93	92	88	89	89	85	84	81	77
Gross profit	(131)	(129)	(5)	7	8	12	11	11	15	16	19	23
Operating expense:												
Research and development	151	127	42	20	24	29	21	22	30	21	14	13
Sales and marketing	44	30	12	8	7	12	10	12	17	14	10	10
General and administrative	46	30	10	9	9	13	10	10	18	13	9	7
Total operating expenses	242	187	64	37	40	54	42	43	64	48	33	30
Loss from operations	(372)	(316)	(69)	(29)	(32)	(42)	(31)	(32)	(50)	(32)	(14)	(7)
Other income (expense), net	(1)	(15)	1	—	(1)	(3)	(2)	(2)	(2)	(3)	(2)	(3)
Net loss	(373%)	(331%)	(68%)	(29%)	(33%)	(45%)	(33%)	(34%)	(51%)	(35%)	(16%)	(10%)

Quarterly Revenue Trends

Our quarterly results reflect seasonality and cyclicity in the sale of our products. In general, we expect our product revenue in the third and fourth quarters to be positively affected by seasonal customer demand trends, including solar economic incentives, weather patterns and construction cycles. Although these seasonal factors are common in the solar sector, historical patterns should not be considered a reliable indicator of our future sales activity or performance. In the future, the effects of seasonality and cyclicity may also be impacted by our expansion into international markets.

Total revenue and unit sales have generally increased over the 12 quarters presented due to the adoption of our existing products, the success of new product introductions and our ability to acquire new customers in our target markets as well as increased sales to existing customers. Quarterly revenue generally has increased sequentially during the last 12 quarters, with revenue increasing from the preceding period in nine of the 12 quarters presented. Sequential revenue growth in the fourth quarter of 2009 resulted from the successful introduction of our second generation microinverter launched at the end of the previous quarter. In the second quarter of 2010, revenues were negatively affected by an unexpected increase in channel inventory caused by temporary weakness in installer demand and overall market dynamics in the solar industry. Installer demand in early 2010 was impacted by an unseasonably long winter, resulting in sluggish consumer demand for solar systems. Since this time, we have improved our visibility into channel inventory levels through programs designed to incent our distributors to provide timely reporting related to inventory levels. In the first quarter of 2011, the decline in net revenues from the preceding quarter was primarily the result of seasonality. We experienced substantial increases in revenues in the second and third quarters of 2011 due, in part, to the launch of our third generation microinverter in June 2011. During the fourth quarter of 2011, net revenues were positively impacted by sales driven, in part, by the anticipated expiration of certain government incentives for investments in renewable energy projects on December 31, 2011, including our sale of \$6.4 million in December 2011 to a customer that is majority-owned by KPCB Holdings, Inc., as nominee, a related party which holds shares of our preferred and common stock and our convertible notes.

Quarterly Gross Profit Trends

Our gross profit, as a percentage of revenue, is impacted by average selling prices, product costs, geographical mix and seasonality. Gross profit generally has improved over the 12 quarters presented due to improvements in product costs resulting from economies of scale and improvements in production processes and automation, which have lowered the overall unit production cost over time. Gross profit has also benefited from our generating sales volumes sufficient to cover personnel and other costs not directly affected by sales volume. Gross profit has improved sequentially in eleven of the 12 quarters presented. Gross profit has fluctuated on a quarterly basis primarily due to shifts in the average selling prices for our products and product costs. Gross profits in the third and fourth quarters of 2009 improved sequentially primarily due to the successful introduction of our lower-cost, second generation microinverter which had completely replaced our first-generation product by the end of 2009. Gross profits in the third and fourth quarters of 2010 were negatively impacted by costs incurred to expedite the procurement and delivery of certain raw materials and finished goods. Gross profit in the first quarter of 2011 increased sequentially due to lower product cost per unit and reduced use of expedited air-freight for finished goods to meet demand due to improvements in delivery scheduling. Gross profit continued to improve sequentially in each of the last three quarters of 2011 primarily due to an increasing mix of our third generation microinverter (introduced in June 2011), which has a lower cost per unit than our second generation microinverter. We anticipate that gross profit will fluctuate from quarter to quarter as a result of changes in average selling prices, product costs, geographical mix and seasonality.

Quarterly Operating Expense Trends

To establish operational scale and to accommodate our growth, our operating expenses increased sequentially in all quarters. Increases in operating expenses have been largely attributable to adding headcount in all areas including investments in research and development activities, sales and marketing efforts and increases in general and administrative expenses for accounting and professional fees. We expect to continue to increase our operating expenses in absolute dollar amounts to support the growth of our company, although over time we expect these expenses to decrease as a percentage of revenue.

Liquidity and Capital Resources

We have financed our operating activities and capital expenditures to date primarily through proceeds from the issuances of convertible preferred stock, debt borrowings and cash receipts from customers. As of December 31, 2011, we had \$51.5 million in cash and cash equivalents and \$29.4 million of working capital.

The following table summarizes our cash flows for the periods indicated:

	Year Ended December 31,		
	2009	2010	2011
	(in thousands)		
Net cash used in operating activities	\$(18,887)	\$(17,852)	\$ (367)
Net cash used in investing activities	(2,122)	(3,262)	(14,662)
Net cash provided by financing activities	25,515	52,465	26,482

Net Cash Used in Operating Activities

We have experienced net negative cash flows from operations as we have expanded our business and built our infrastructure. Our cash flows from operating activities will continue to be affected principally by the extent to which we manage our working capital and spend on increasing personnel in order to grow our business. Our largest source of operating cash flows is cash collections from our customers.

For the year ended December 31, 2011, despite a net loss of \$32.3 million, cash used in operating activities approximated break-even primarily due to a \$25.4 million increase in deferred revenues. In December 2011, we

[Table of Contents](#)

entered into agreements to sell microinverters to customers, with product delivery in 2012. These agreements were due, in part, to the anticipated expiration of certain government incentives for investments in renewable energy projects on December 31, 2011. Prior to December 31, 2011, we received \$23.5 million in cash in advance from these customers, of which \$23.0 million was included in deferred revenues. Delivery and recognition of these deferred revenues is expected in the first half of 2012. Our net loss included non-cash charges in the form of depreciation and amortization of \$3.0 million, stock-based compensation of \$2.1 million and non-cash interest expense of \$1.8 million related to the amortization of debt discounts and deferred financing costs. Changes in working capital items other than deferred revenues used \$1.0 million of operating cash flow and consisted of increases in accounts receivable, inventory and prepaid and other assets offset by increases in accounts payable and other accrued liabilities.

Accounts receivable and inventory increased by a total of \$16.5 million from \$12.5 million at December 31, 2010 to \$29.0 million at December 31, 2011, reflecting increased revenue and inventory purchases. Increases in prepaid and other assets contributed an additional \$1.6 million decrease in cash. These decreases in cash were offset by increases in accounts payable and other accrued liabilities of \$17.3 million, due in large part to higher inventory levels required to fulfill our deferred revenue obligations.

Cash used in operating activities decreased from 2009 to 2010 by \$1.0 million. The decrease was primarily driven by an improvement of working capital management of approximately \$4.5 million as our sales volume increased substantially, partially offset by a \$4.9 million increase in net loss due to the overall growth in our business activities and an increase in employee headcount across all functions.

Net Cash Used in Investing Activities

Net cash used in investing activities primarily relates to capital expenditures to support our growth.

Net cash used in investing activities in 2011 were \$14.7 million and related primarily to purchases of manufacturing test equipment and the development of software for internal use.

Net cash used in investing activities in 2010 were \$3.3 million and consisted of leasehold improvements for corporate offices, manufacturing test equipment, lab equipment for research and development, and the development of software for internal use.

Net cash used in investing activities in 2009 were \$2.1 million and related primarily to purchases of manufacturing test equipment and lab equipment for research and development.

Net Cash Provided by Financing Activities

We have financed our operations primarily through private sales of convertible preferred stock and convertible notes totaling \$115.2 million through December 31, 2011, and, to a lesser extent, the use of venture debt and credit facilities.

Net cash provided by financing activities in 2011 consisted of \$19.7 million in net proceeds received from the issuance of our convertible notes, \$9.3 million in net proceeds from an equipment financing facility and a venture debt term loan and \$1.9 million from the sale of common stock partially offset by \$2.6 million in direct costs incurred in connection with the preparation of our registration statement of which this prospectus is a part and \$2.0 million related to payments on our term loans and capital lease obligations.

Net cash provided by financing activities in 2010 consisted of \$45.7 million in net proceeds received from our Series E convertible preferred stock issuance and \$7.0 million from a venture debt term loan.

Net cash provided by financing activities in 2009 consisted of \$24.2 million in net proceeds received from our Series D convertible preferred stock issuance and \$1.5 million from the issuance of convertible notes.

Debt Obligations

Our debt obligations are summarized below. Our Convertible Facility, Term Loans and Revolving Line of Credit Facility are secured by substantially all of our assets except intellectual property and contain certain required financial covenants. As of December 31, 2011, we were in compliance with these required financial covenants.

Convertible Facility

In June 2011, we entered into a junior secured convertible loan facility, or Convertible Facility, with certain existing preferred stockholders that provided for up to \$50.0 million in borrowings, of which we borrowed \$12.5 million in an initial advance upon signing. In November 2011, we amended the Convertible Facility to provide for an aggregate of up to \$80.0 million in borrowings. We borrowed \$7.5 million in a second advance in November 2011 and may borrow up to an additional \$60.0 million prior to the earlier of (i) a subsequent equity financing of more than \$10.0 million or (ii) June 14, 2013, subject to the attainment of certain financial and operating conditions. In March 2012, we further amended the Convertible Facility to provide for the automatic conversion of the principal amount and paid-in-kind interest under the Convertible Facility into common stock upon closing of this offering at a conversion price equal to the lesser of \$8.8984 or the initial public offering price. The Convertible Facility bears interest at a rate of 9.0%, with interest payable in-kind at maturity, which is the earlier to occur of the closing of (i) our initial public offering, (ii) a change in control or (iii) June 14, 2014. Because the notes were issued at a discount, we record interest expense in excess of the stated rate. The initial and second advances totaling \$20.0 million, together with any accrued interest, are convertible into common stock at a conversion price equal to the lesser of \$8.8984 or the initial public offering price. Additional borrowings and accrued interest are repayable at the holders' option as follows: up to 50% convertible into common stock at a price equal to the lesser of \$8.8984 or the initial public offering price, and the remainder in cash. In addition, we may prepay, at our election, up to 50% of any additional borrowings and related accrued interest at any time. In connection with this facility, in June and November 2011 we issued shares of common stock and warrants to purchase common stock. See Notes 7 and 10 to Consolidated Financial Statements. The Convertible Facility is secured by all of our assets except intellectual property, prohibits dividend payments and restricts prepayment of the convertible portion of any outstanding loans under the facility. The agreement also requires us to meet certain minimum gross profit metrics and maximum warranty claim rates in order to be eligible for further advances under the facility.

Equipment Financing Facility

On June 13, 2011, we entered into \$5.0 million equipment financing facility with Hercules Technology Growth Capital, Inc. The equipment financing facility has a variable interest rate set at the higher of 5.75% above the prime lending rate and 9.0% annually and expires July 1, 2014. This facility is secured by the financed equipment and restricts our ability to pay dividends and take on certain types of additional liens. In connection with this facility, we issued warrants to purchase Series E preferred stock. See Note 10 to Consolidated Financial Statements. As of December 31, 2011, we have borrowed \$4.9 million under the equipment financing facility.

Term Loans

We have a loan and security agreement with Horizon Technology Finance Corporation, or Original Term Loan, pursuant to which we borrowed \$7.0 million at an interest rate of 12.6% for a 42-month term, maturing on October 1, 2013. On March 25, 2011, we entered into an amendment to the Original Term Loan to provide for an additional \$2.0 million term loan, which was fully drawn upon at execution of the amendment and an additional \$3.0 million term loan, which was fully drawn upon on September 22, 2011, together, the Additional Term Loans, both of which mature on the first calendar day of the month that follows the 42-month anniversary of the date of advance. As of December 31, 2011, \$2.0 million of the outstanding principal balance of the Additional

[Table of Contents](#)

Term Loans will mature on October 1, 2014 and the remaining \$3.0 million outstanding principal balance will mature on April 1, 2015. The Additional Term Loans have an interest rate of 10.75% and all borrowings have a 42-month term. Monthly payments for the first 12 months are interest only; subsequent monthly payments include interest and principal, based on a 30-month remaining amortization period. The other terms and conditions of the Original Term Loan remain substantially unchanged. The loan provides for penalties for early repayment and is secured by all our assets except intellectual property. The loan also prohibits any dividend payments and restricts our ability to take on certain additional liens, or make prepayments on certain other indebtedness.

Revolving Line of Credit Facility

In March, 2011, we entered into a revolving line of credit under a loan and security agreement with Bridge Bank, National Association and Comerica Bank that provides for up to \$25.0 million in borrowings, based on a percentage of eligible receivables and a percentage of inventory, up to \$10.0 million. The line of credit has a variable interest rate set at 1.25% above the bank's prime lending rate and was to expire March 24, 2013. The facility included a \$5.0 million letter of credit subfacility. Any advance under the facility is collateralized by the underlying receivables or inventory and is secured by all of our assets except intellectual property. The agreement requires us to maintain minimum asset coverage and tangible net worth requirements and restricts our ability to pay dividends, take on certain additional liens, or make prepayments on certain other indebtedness.

On December 30, 2011, we increased our revolving line of credit from \$25.0 million to \$33.0 million, including an increase of the letter of credit subfacility from \$5.0 million to \$10.0 million, and further extended the availability of the facility until December 30, 2013. Available borrowings are based on 80% of eligible receivables and 50% of inventory, up to \$13.2 million. As of December 31, 2011, we had not drawn down under this facility. As required by the terms of the agreement, in March 2012 we borrowed \$2.6 million under this facility.

Line of Credit Agreement

We had a line of credit agreement with ATEL Ventures, Inc. that provided for borrowings of up to \$1.0 million. The line of credit had an interest rate of approximately 14% and expired on January 1, 2012. As of December 31, 2011, this line of credit had an outstanding principal balance of \$28,000, which was repaid in January 2012. Specific assets were pledged as collateral for amounts drawn under the line of credit. Any amounts drawn under the line of credit are subject to penalties for early repayment. The line of credit does not include financial covenants or other material covenant requirements.

Operating and Capital Expenditure Requirements

Since inception, our operations have been financed primarily through sales of our convertible preferred stock and convertible notes. Our principal current sources of liquidity are cash on our balance sheet, cash generated by sales of products, borrowings under our credit facilities and our Convertible Facility.

Based on our current financial condition, we believe that liquidity from available sources without giving effect to the proceeds from this offering will be adequate to fund our current and long-term debt obligations as well as our planned capital expenditures and business plans over the next 12 months. In the future, we expect our operating and capital expenditures to increase as we increase headcount, expand our business activities and grow our customer base which will result in higher needs for working capital. Our ability to generate cash from operations is also subject to substantial risks described under the caption "Risk Factors." If any of these risks occur, we may be unable to generate or sustain positive cash flow from operating activities or raise additional capital. We would then be required to use existing cash and cash equivalents to support our working capital and other cash requirements. If additional sources of liquidity are required to support our working capital requirements or operational expansion, we may seek to raise funds through debt financing or from other sources, but we can provide no assurance that these transactions could be consummated on acceptable terms to us or at all. Failure to raise sufficient capital when needed could have a material adverse effect on our business, results of operations and financial position.

[Table of Contents](#)

Contractual Obligations

The following table summarizes our outstanding contractual obligations as of December 31, 2011:

	Payments Due by Period				
	Total	Less Than 1 Year	1-3 Years	4-5 Years	More Than 5 Years
Term Loans	\$ 15,268	\$ 5,095	(in thousands) \$ 9,725	\$ 448	\$ —
Interest payments on debt	2,426	1,459	957	10	—
Convertible notes	20,713	—	20,713	—	—
Capital leases	189	112	77	—	—
Operating leases	15,032	1,457	2,949	3,090	7,536
Purchase commitments under agreements ⁽¹⁾	138,194	33,653	37,530	67,011	—
Total	\$191,822	\$41,776	\$71,951	\$70,559	\$7,536

(1) Represents amounts associated with our contract manufacturers that are non-cancelable. Such purchase commitments are based on our forecasted manufacturing requirements and typically provide for fulfillment within agreed upon lead-times and/or commercially standard lead-times for the particular part or product. The timing and amount of payments represent our best estimate and may change due to changing business needs and other factors. Certain agreements specify future quantities and pricing of products to be supplied by our contract manufacturers for periods up to seven years. In the event we do not meet our minimum purchase commitments or if we terminate such long-term agreements, we are responsible for liquidated damages of up to \$5.4 million.

Off-Balance Sheet Arrangements

Since our inception, we have not engaged in any off-balance sheet arrangements, such as the use of structured finance, special purpose entities or variable interest entities.

Critical Accounting Policies and Significant Management Estimates

Our consolidated financial statements are prepared in accordance with accounting principles generally accepted in the U.S., or GAAP. In connection with the preparation of our consolidated financial statements, we are required to make assumptions and estimates about future events, and apply judgments that affect the reported amounts of assets, liabilities, revenue, expenses and the related disclosures. We base our assumptions, estimates and judgments on historical experience, current trends and other factors that management believes to be relevant at the time our consolidated financial statements are prepared. On a regular basis, we review the accounting policies, assumptions, estimates and judgments to ensure that our consolidated financial statements are presented fairly and in accordance with GAAP. However, because future events and their effects cannot be determined with certainty, actual results could differ from our assumptions and estimates, and such differences could be material.

Our significant accounting policies are discussed in Note 2 to Consolidated Financial Statements. We believe that the following accounting estimates are the most critical to aid in fully understanding and evaluating our reported financial results, and they require our most difficult, subjective or complex judgments, resulting from the need to make estimates about the effect of matters that are inherently uncertain.

Revenue Recognition

Our primary source of revenues is the sale of microinverter systems. Our products are fully functional at the time of shipment and do not require production, modification or customization. We currently sell our products primarily to distributors, who typically resell our products to end users. We also sell directly to large installers as well as through OEMs, who integrate our products into complete solutions, and strategic partners.

Revenues from the sales of microinverters and communication gateway devices are recognized when: (i) persuasive evidence of an arrangement exists; (ii) delivery of the products has occurred in accordance with the

[Table of Contents](#)

terms of the sales agreement and title of and risk of loss has passed to the customer; (iii) the sale price is fixed or determinable; and (iv) collection is reasonably assured. Title to the product typically passes upon shipment of the product, as our products are typically shipped FOB shipping point. We do not offer rights to return our products other than for normal warranty conditions. As such, we recognize revenues upon shipment, assuming all other revenue recognition criteria have been met. As of December 31, 2011, deferred revenues related to products included \$23.0 million in payments received from customers in advance of revenue recognition, as delivery of the products has not yet occurred. See Note 16 to the Consolidated Financial Statements. We occasionally offer promotional program incentives including rebates and discounts on a limited time basis to installers and distributors based on the number of installations and unit sales, respectively. Such customer incentives are not material and are estimated using our historical experience. Incentives are recorded as reductions to net revenues at the time of sale or over the period of time in which they are earned, depending on the nature of the program.

Prior to June 2011, we sold Envoy communications gateway devices and our Enlighten web-based monitoring service separately. Revenues from our Enlighten web-based monitoring services were recognized ratably over the term of the service period, which is generally one or five years. Historically, Enlighten service revenue has represented less than 1% of total revenues in any given reporting period. Beginning in June 2011, each sale of an Envoy communications gateway device includes our Enlighten web-based monitoring service. After allocating the overall consideration from such sale to each deliverable using a best estimate of the selling price, (i) revenues from the sale of Envoy devices is recognized upon shipment, assuming all other revenue recognition criteria have been met and (ii) revenues from the web-based monitoring service is recognized ratably over the estimated economic life of the related Envoy devices. We expect revenues from our web-based monitoring service will continue to be insignificant.

Inventory Valuation

Inventories are valued at the lower of cost or market, on a first-in, first-out basis. Certain factors could affect the realizable value of our inventories including market and economic conditions, technological changes, new product introductions and changes in strategic direction. We consider historic usage, expected demand, anticipated sales price, the effect of new product introductions, product obsolescence, customer concentrations, product merchantability and other factors when evaluating the value of inventories. Inventory write-downs are equal to the difference between the cost of inventories and their estimated fair market value. Inventory write-downs are recorded as cost of revenues in the accompanying statements of operations and were \$50,000, \$0.1 million and \$2.7 million in 2009, 2010 and 2011, respectively. Inventory write-downs in 2011 were primarily the result of inventory obsolescence related to products discontinued during the year.

We do not believe there is a reasonable likelihood that there will be a material change in the future estimates or assumptions that we use to record inventory at the lower of cost or market. However, if estimates regarding customer demand are inaccurate or changes in technology affect demand for certain products in an unforeseen manner, we may be exposed to losses that could be material.

Product Warranty

We provide a warranty against defects in materials and workmanship under normal use and service conditions for our microinverters. Our first and second generation microinverters include a 15-year limited warranty. Our third generation microinverters provide for a 25-year limited warranty period. Since we have only been producing microinverters for a comparatively short period, the calculation of warranty provisions is inherently uncertain. We accrue for estimated warranty costs at the time of sale based on anticipated warranty claims and actual historical warranty claims experience. Warranty provisions are computed on a per unit sold basis and are based on our best estimate of such costs and are included in cost of revenues. The warranty obligation is determined based on product failure rates, cost of replacement and service and delivery costs incurred to correct a product failure. Our warranty obligation requires management to make assumptions regarding estimated failure rates and replacement costs. Our estimated costs of warranty for previously sold products may change to the extent future products are not compatible with earlier generation products under

[Table of Contents](#)

warranty. Product failure rates are estimated primarily by using field monitoring of the actual failure rates of the microinverters we have sold to date. With over 1,550,000 of our microinverter units sold across North America through December 31, 2011, we have established reliability based on the units' estimated mean time between failure, or MTBF, a metric that equates to a steady-state failure rate of approximately 0.3% per year for current generation products. The MTBF represents the predicted mean elapsed time to microinverter unit failure during system operation. In addition, due to our limited operating history, we also utilize third party data collected on similar equipment deployed in outdoor environments similar to those in which our microinverters are installed, as well as accelerated life cycle testing, which simulates the service life of the product in a short period of time. The accelerated life cycle tests incorporate test methodologies derived from standard tests used by solar module vendors to evaluate the period over which solar modules wear out. Predicted failure rates are updated periodically based on field return data. Corresponding replacement costs are updated periodically to reflect changes in our actual and estimated production costs for our microinverters. Furthermore, changes to the warranty provision as a percentage of microinverter units sold will vary based on the replacement cost of the specific generation of microinverter unit under warranty. In addition, different generations of microinverters may have different warranty terms which further contribute to changes in the warranty provision as a percentage of microinverter units sold. For example, our first and second generation microinverters have a 15-year warranty while our third generation microinverter has a 25-year warranty. If actual warranty costs differ significantly from these estimates, adjustments may be required in the future, which could adversely affect our gross profit and operating results. The warranty provision was \$1.0 million, \$1.9 million and \$7.0 million in 2009, 2010 and 2011, respectively. The increase in warranty provision in 2011 compared to 2010 was comprised of approximately \$3.7 million due to the number of microinverters sold, which increased by 142% from approximately 414,000 units in 2010 to approximately 1.0 million units in 2011, and approximately \$1.4 million to reflect increased estimated replacement costs for certain products and other changes in estimates.

In addition, we support our microinverters with our Entrust program. We reimburse the system owner for any lost energy for up to one month if a microinverter unit should fail (which we refer to as our "100% uptime guarantee"). We estimate that our microinverter systems achieve system uptimes of over 99.8%. Historically, disbursements under the Entrust program have been insignificant, and therefore no accruals have been recorded for any such future obligations.

Stock-Based Compensation

The accounting for share-based payments requires the measurement and recognition of compensation expense for all share-based payment awards made to employees and directors based on the grant date fair values of the awards. The fair value of each stock option granted is estimated using the Black-Scholes option pricing model. Stock-based compensation, net of estimated forfeitures, is recognized on a straight-line basis over the requisite service period, which is typically four years. Stock-based compensation expenses are classified based on the employee's functional department.

The Black-Scholes option pricing model requires management to make assumptions and to apply judgment in determining the fair value of our awards. The most significant assumptions and judgments include estimating the fair value of underlying stock, expected volatility and expected term. In addition, the recognition of stock-based compensation expense is impacted by estimated forfeiture rates.

Our board of directors has historically set the exercise price of options to purchase our common stock at a price per share not less than the fair value of the common stock at the time of grant. To determine the fair value of our common stock, our board of directors, with input from management, considered many factors, including but not limited to:

- valuations we performed using the methodologies described below;
- our historical, current and expected future operating performance;

[Table of Contents](#)

- recent prices at which our preferred stock was sold, including the liquidation rights and other preferences of our preferred stock;
- our financial condition at the date of grant;
- achievement of product development milestones;
- lack of marketability of our common stock associated with private company status and the potential future marketability of our common stock as a result of a liquidity event, such as an initial public offering;
- business risks inherent in our business and in technology, solar and clean technology companies generally; and
- macroeconomic trends and capital market conditions.

We estimated the expected volatility based on the historical volatilities of several comparable public companies within the solar and clean technology industries because our common stock has no trading history. The weighted-average expected life of options was calculated using the “simplified” method developed by the SEC staff. The risk-free interest rate is based on the U.S. Treasury yields in effect at the time of grant for periods corresponding to the expected term of the options. The expected dividend rate is zero based on the fact that we have not historically paid dividends and have no intention to pay cash dividends in the foreseeable future. The forfeiture rate is estimated based on the historical average period of time that options were outstanding and adjusted for expected changes in future exercise patterns.

Total stock-based compensation expense recognized for 2009, 2010 and 2011 was \$0.2 million, \$0.8 million and \$2.1 million, respectively. The fair value of each option granted during the periods presented was estimated on the date of grant using the Black-Scholes option pricing model with the following weighted-average assumptions:

	Year Ended December 31,		
	2009	2010	2011
Expected term (in years)	5.9	6.0	6.0
Expected volatility	76.4%	73.3%	72.0%
Annual risk-free rate of return	2.8%	2.2%	1.8%
Dividend yield	0.0%	0.0%	0.0%

As of December 31, 2011, there was approximately \$6.5 million of total unrecognized compensation cost related to unvested stock options, net of expected forfeitures, which is expected to be recognized over a weighted-average period of 3.0 years.

No income tax benefit has been recognized relating to stock-based compensation expense and no tax benefits have been realized from exercised stock options.

[Table of Contents](#)

The following table summarizes all option grants from January 1, 2010 through December 31, 2011:

<u>Grant Date</u>	<u>Number of Options Granted</u>	<u>Per Share Exercise Price</u>	<u>Common Stock Fair Value Per Share at Grant Date</u>
November 2011	46,024	\$ 9.53	\$ 9.81
September 2011	96,581	9.53	9.53
August 2011	342,970	9.53	9.53
June 2011	90,238	5.27	8.35
May 2011	244,810	4.09	6.99
January 2011	289,784	2.54	4.09
November 2010	325,534	2.09	3.54
July 2010	1,427,659	1.63	2.63
June 2010	481,530	1.63	2.27
January 2010	313,473	0.64	0.64

In February and March 2012, we granted options to purchase approximately 78,732 and 214,917 shares of common stock with an exercise price of \$10.35 and \$11.00 per share, respectively.

In the absence of a public trading market for our common stock, management and our board of directors determined the estimated fair value at the grant date of our common stock. We performed the valuation of our common stock in accordance with the guidelines outlined in the American Institute of Certified Public Accountants Practice Aid, Valuation of Privately-Held-Company Equity Securities Issued as Compensation. In order to value the common stock underlying all option grants, we determined our business equity value by taking a weighted combination of the value indications using two valuation approaches: an income approach and a market approach.

Valuation models employed in determining our enterprise value require the input of highly subjective assumptions. In determining enterprise value under the income approach, a discount rate is applied to the estimated future net cash flows of a company to derive a single present value representing the value of the enterprise. The discounted cash flow model used to calculate our enterprise value included, among others, the following assumptions: projections of revenues and expenses and related cash flows based on assumed long-term growth rates and demand trends; expected future investments to grow our business; and, an appropriate risk-adjusted discount rate. The market approach estimates the fair value of a company by applying market multiples of the corresponding financial metrics of publicly traded firms in similar lines of business to our historical and/or projected financial metrics. We selected comparable companies based on factors such as business similarity, financial risk, company size and geographic markets. In applying this method, valuation multiples were: (i) derived from historical operating data of the selected comparable entities; (ii) evaluated and/or adjusted based on our strengths and weaknesses relative to the comparable entities; and (iii) applied to our operating data to arrive at a value indication.

Enterprise value, adjusted for cash and debt, was allocated to the shares of convertible preferred stock, warrants, options and shares of common stock using an option pricing method or a probability-weighted estimated return method, or PWERM, depending on our stage of development. The option pricing method treats convertible preferred stock, warrants, options and shares of common stock as call options on the total equity value of a company, and uses the Black-Scholes option pricing model to price the call options. This model defines the securities' fair values as functions of the current fair value of a company and requires the use of assumptions such as the anticipated holding period and the estimated volatility of the equity securities.

Under the PWERM, the value of common stock is estimated based upon an analysis of future values for the enterprise assuming various scenarios and potential future expected outcomes (e.g., an initial public offering, or

[Table of Contents](#)

IPO, a merger or sale, continuing as a private company, or dissolution with no value to common stockholders). Enterprise value is allocated to convertible preferred stock, warrants, options and shares of common stock based on the rights and characteristics of each equity instrument. The resulting share value is based upon the probability-weighted present value of expected future investment returns.

In 2010 and prior periods, our valuations were based upon the option-pricing method. Beginning January 2011, our valuations have been prepared based upon the PWERM.

The following discusses the factors considered by our board of directors in determining the exercise price of our common stock at each of the grant dates specified below and management's consideration of fair value for stock compensation purposes.

November 3, 2011. Our board of directors determined the exercise price of our common stock of \$9.53 per share at the grant date based upon the results of our valuation as of September 30, 2011, which estimated the value of our common stock at \$9.53 per share, and included the following key assumptions:

- Discount rate of 25% based on the calculated weighted average cost of capital and lack of marketability discount of 10% based on a reduction in the assumed time to a liquidity event to occur to approximately two months;
- Application of the PWERM, assuming 85% probability of an IPO, 10% probability of merger or sale, 5% probability of continuing as a private company and a 0% probability of dissolution/no value to common stockholders; and
- Reduction in the revenue multiples of the comparable companies used in the analysis due to the declines in the valuation of public solar companies from June 30, 2011 to September 30, 2011.

However, we subsequently determined that a stock compensation charge should be calculated for the difference between the \$9.53 per share exercise price at the grant date and a revised estimated fair value of \$9.81 per common share at the grant date, based on the following:

- Increase in net revenues of 28% from \$44.7 million in the three months ended September 30, 2011 to \$57.1 million in the three months ended December 31, 2011;
- Increase in gross profit percentage from 19.1% in the three months ended September 30, 2011 to 22.8% in the three months ended December 31, 2011.

We subsequently conducted a valuation as of December 31, 2011, which estimated the value of our common stock at \$10.35 per share, and included the following key assumptions:

- Discount rate of 25% based on the calculated weighted average cost of capital and lack of marketability discount of 5% based on a reduction in the assumed time to a liquidity event to occur to approximately two months;
- Application of the PWERM, assuming 90% probability of an IPO and 10% probability of merger or sale; and
- A slight reduction in the revenue multiples of the comparable companies used in the analysis due to continued weakness in the valuation of public solar companies from September 30, 2011 to December 31, 2011.

A retrospective extrapolation based upon the fair value determined as of December 31, 2011 and consideration of the items discussed above resulted in a revised estimated fair value of \$9.81 as of the November 3, 2011 grant date.

[Table of Contents](#)

As a result, additional compensation expense of \$10,000 related to the November 3, 2011 grants will be recognized over the four year vesting period of the options.

August 23, 2011 and September 15, 2011. Our board of directors determined the exercise price of our common stock of \$9.53 per share at the grant date based upon the results of our valuation as of June 30, 2011, which estimated the value of our common stock at \$9.53 per share, and included the following key assumptions:

- Discount rate of 24% based on the calculated weighted average cost of capital and lack of marketability discount of 10% based on a reduction in the assumed time to a liquidity event to occur to approximately three months; and
- Application of the PWERM, assuming 75% probability of an IPO, 15% probability of merger or sale, 10% probability of continuing as a private company and a 0% probability of dissolution/no value to common stockholders.

We subsequently conducted a valuation as of September 30, 2011, which estimated the value of our common stock at \$9.53 per share, and included the following key assumptions:

- Discount rate of 25% based on the calculated weighted average cost of capital and lack of marketability discount of 10% based on a reduction in the assumed time to a liquidity event to occur to approximately two months;
- Application of the PWERM, assuming 85% probability of an IPO, 10% probability of merger or sale, 5% probability of continuing as a private company and a 0% probability of dissolution/no value to common stockholders; and
- Reduction in the revenue multiples of the comparable companies used in the analysis due to the declines in the valuation of public solar companies from June 30, 2011 to September 30, 2011.

As a result, no additional stock compensation expense was recorded related to these grants.

June 3, 2011. Our board of directors determined the exercise price of our common stock of \$5.27 per share at the grant date based upon the results of our valuation as of March 31, 2011, which estimated the value of our common stock at \$5.27 per share, and included the following key assumptions:

- Discount rate of 23% based on the calculated weighted average cost of capital and lack of marketability discount of 14% based on a reduction in the assumed time to a liquidity event to occur to approximately six months; and
- Application of the PWERM, assuming 65% probability of an IPO, 15% probability of merger or sale, 15% probability of continuing as a private company and a 5% probability of dissolution/no value to common stockholders.

However, we subsequently determined that a stock compensation charge should be calculated for the difference between the \$5.27 per share exercise price at the grant date and a revised estimated fair value of \$8.35 per common share at the grant date, based on the following:

- June 6, 2011 launch of our third generation microinverter and the sale of a significant amount of units in June 2011;
- June 13, 2011 equipment financing with an unrelated third party of \$5 million and the related issuance of warrants to purchase 25,285 shares of Series E convertible preferred stock at \$8.8984 per share and consideration of the voting, conversion, dividend, liquidation, and other rights and preferences of the preferred shares relative to those of the outstanding common shares;
- June 14, 2011 Convertible Facility with certain existing preferred stockholders that provided for up to \$50.0 million in borrowings and in consideration thereon, we issued (i) 208,209 shares of common

[Table of Contents](#)

stock at \$5.27 per share in cash, and (ii) warrants to purchase 76,601 shares of common stock at \$5.27 per share;

- The June 15, 2011 filing of a registration statement on Form S-1 with the Securities and Exchange Commission for an initial public offering of common stock;
- Substantial increase in revenues from \$18.1 million in the three months ended March 31, 2011 to \$29.6 million in the three months ended June 30, 2011;
- Increase in the number of microinverters sold from 148,000 units in the first six months of 2010 to 327,000 units in the first six months of 2011 or 121%, and from 123,000 units in the three months ended March 31, 2011 to 204,000 units in the three months ended June 30, 2011 or 66% ;
- Increase in gross profit percentage from 14.7 % in the three months ended March 31, 2011 to 16.2% in the three months ended June 30, 2011;
- The results of our valuation as of June 30, 2011, which estimated the value of our common stock at \$9.53 per share, and included the following key assumptions:
 - Discount rate of 24% based on the calculated weighted average cost of capital and lack of marketability discount of 10% based on a reduction in the assumed time to a liquidity event to occur to approximately three months; and
 - Application of the PWERM, assuming 75% probability of an IPO, 15% probability of merger or sale, and 10% probability of continuing as a private company.

A retrospective extrapolation based upon the fair value determined as of June 30, 2011 and consideration of the items discussed above resulted in a revised estimated fair value of \$8.35 as of the June 3, 2011 grant date.

As a result, additional compensation expense of \$241,000 related to the June 3, 2011 grants will be recognized over the four year vesting period of the options.

May 5, 2011. Our board of directors determined the exercise price of our common stock of \$4.09 per share at the grant date based on results of our valuation as of January 31, 2011, which estimated the value of our common stock at \$4.09 per share (as discussed below).

However, we subsequently determined that a stock compensation charge should be calculated for the difference between the \$4.09 per share exercise price at the grant date and the estimated fair value of \$6.99 per common share at the grant date, based on the following:

- June 6, 2011 launch of our third generation microinverter;
- June 13, 2011 equipment financing with an unrelated third party of \$5 million and the related issuance of warrants to purchase 25,285 shares of Series E convertible preferred stock at \$8.8984 per share and consideration of the voting, conversion, dividend, liquidation, and other rights and preferences of the preferred shares relative to those of the outstanding common shares;
- June 14, 2011 Convertible Facility with certain existing preferred stockholders that provided for up to \$50.0 million in borrowings and in consideration thereon, we issued (i) 208,209 shares of common stock at \$5.27 per share in cash, and (ii) warrants to purchase 76,601 shares of common stock at \$5.27 per share;
- The June 15, 2011 filing of a registration statement on Form S-1 with the Securities and Exchange Commission for an initial public offering of common stock;
- Consideration of the results of our valuation as of June 30, 2011, which estimated the value of our common stock at \$9.53 per share as of June 30, 2011, as discussed above; a retrospective extrapolation based upon the fair value determined as of June 30, 2011 and consideration of items discussed above resulted in a revised estimated fair value of \$6.99 as of the May 5, 2011 grant date.

[Table of Contents](#)

As a result, additional compensation expense of \$618,000 related to the May 5, 2011 grants will be recognized over the four year vesting period of the options.

January 2011. Our board of directors determined the exercise price of our common stock of \$2.54 per share at the grant date based on results of our valuation as of November 30, 2010, which estimated the value of our common stock at \$2.54 per share and included the following key assumptions:

- The business enterprise value based on a weighted income approach and market approach of \$184.0 million, an increase from the prior external valuation of \$167.5 million as of August 31, 2010;
- Discount rate of 35% based on the calculated weighted average cost of capital; and
- Lack of marketability discount of 24%.

However, we subsequently determined that a stock compensation charge should be calculated for the difference between the \$2.54 per share exercise price at the grant date and the estimated fair value of \$4.09 per common share at the grant date, based on the following:

- The issuance of Series E Convertible Preferred Stock at \$6.174 per share in March, April and May 2010 resulting in cash proceeds of \$45.7 million, and consideration of the voting, conversion, dividend, liquidation, and other rights and preferences of the preferred shares relative to those of the outstanding common shares. We took into account all preferences and other rights, as described in Note 9 to Consolidated Financial Statements, when determining the value of our common stock as compared to the value of our convertible preferred stock. In particular, liquidation preferences ascribed to convertible preferred stock prior to any distribution of proceeds to holders of our common stock resulted in the value per share of our convertible preferred stock being more than the value per share of our common stock. In addition, we considered the application of PWERM which assumed a 50% probability of an IPO;
- Substantial increase in revenues from \$18.7 million in the three months ended September 30, 2010, to \$20.6 million in the three months ended December 31, 2010;
- Substantial increase in sales of microinverters from 126,000 in 2009 to 414,000 in 2010;
- Meaningful increase in gross profit percentage from (15)% in 2009 to 10.5% in 2010;
- Successful hiring of essential research and development, technical, sales and marketing and administrative personnel, increasing total headcount from 80 at December 31, 2009 to 154 at December 31, 2010;
- Considerable progress made throughout 2010 in the development of our third generation microinverter, which was expected to be available for sale in mid-2011; and
- Consideration of the results of our valuation as of January 31, 2011, which estimated the value of our common stock at \$4.09 per share, and included the following key assumptions:
 - Discount rate of 24% based on the calculated weighted average cost of capital and lack of marketability discount of 15% based on a reduction in the assumed time to a liquidity event to occur to approximately one year; and
 - Application of the PWERM, assuming 50% probability of an IPO, 20% probability of merger or sale, 20% probability of continuing as a private company and a 10% probability of dissolution/no value to common stockholders.

As a result, additional compensation expense of \$388,000 related to the January 2011 grants will be recognized over the four year vesting period of the options.

[Table of Contents](#)

November 2010. Our board of directors determined the exercise price of our common stock of \$2.09 per share at the grant date based on results of our valuation as of August 31, 2010, which estimated the value of our common stock at \$2.09 per share and included the following key assumptions:

- The business enterprise value based on a weighted income approach and market approach of \$167.5 million, an increase from our prior valuation of \$133.5 million as of February 28, 2010;
- Discount rate of 33% based on the calculated weighted average cost of capital; and
- Lack of marketability discount of 28% based on an assumed time to a liquidity event to occur of 1.75 years.

However, we subsequently determined that a stock compensation charge should be calculated for the difference between the \$2.09 per share exercise price at the grant date and the estimated fair value of \$3.54 per common share at the grant date, based on the following:

- The issuance of Series E Convertible Preferred Stock at \$6.174 per share in March, April and May 2010 resulting in cash proceeds of \$45.7 million, and consideration of the voting, conversion, dividend, liquidation, and other rights and preferences of the preferred shares relative to those of the outstanding common shares;
- Substantial increase in revenues from \$10.8 million in the three months ended June 30, 2010, to \$18.7 million and \$20.6 million in the three months ended September 30 and December 31, 2010, respectively;
- Substantial increase in sales of microinverters from 126,000 in 2009 to 414,000 in 2010;
- Meaningful increase in gross profit percentage from (15)% in 2009 to 10.5% in 2010;
- Successful hiring of essential research and development, technical, sales and marketing and administrative personnel, increasing total headcount from 80 at December 31, 2009 to 154 at December 31, 2010;
- Continued improvement in U.S. economy and financial and stock markets;
- Considerable progress made throughout 2010 in the development of our third generation microinverter, which was expected to be available for sale in mid-2011; and
- Consideration of our valuation as of January 31, 2011, which estimated the value of our common stock at \$4.09 per share as of January 2011 (as discussed above); a retrospective straight-line extrapolation based on the fair value determined as of January 31, 2011 resulted in a revised estimated fair value of \$3.54 per common share as of the November 11, 2010 grant date.

As a result, additional compensation expense of \$408,000 related to the November 2010 grants will be recognized over the four year vesting period of the options.

July 2010. Our board of directors determined the exercise price of our common stock of \$1.63 per share at the grant date based on our valuation as of February 28, 2010, which estimated the value of our common stock at \$1.63 per share and included the following key assumptions:

- The business enterprise value based on a weighted income approach and market approach of \$133.5 million, an increase from the prior valuation of \$49.9 million as of October 31, 2009;
- Discount rate of 33% based on the calculated weighted average cost of capital; and
- Lack of marketability discount of 45% based on an assumed time to a liquidity event to occur of approximately two years.

[Table of Contents](#)

However, we subsequently determined that a stock compensation charge should be calculated for the difference between the \$1.63 per share exercise price at the grant date and the estimated fair value of \$2.63 per common share at the grant date, based on the following:

- The issuance of Series E Convertible Preferred Stock at \$6.174 per share in March, April and May 2010 resulting in cash proceeds of \$45.7 million, and consideration of the voting, conversion, dividend, liquidation, and other rights and preferences of the preferred shares relative to those of the outstanding common shares;
- Substantial increase in gross profit percentage from 8.3% in the three months ended March 31, 2010 to 12.1% in the three months ended June 30, 2010;
- Increased likelihood of meeting operating performance benchmarks and forecasted results for the second half of 2010; and
- Consideration of our valuation as of January 31, 2011, which estimated the value of our common stock at \$4.09 per share as of January 2011 (as discussed above); a retrospective straight-line extrapolation based on the fair value determined as of January 31, 2011 resulted in a revised estimated fair value of \$2.63 per common share as of the July 15, 2010 grant date.

As a result, additional compensation expense of \$1,236,000 related to the July 2010 grants will be recognized over the four-year vesting period of the options.

June 2010. Our board of directors determined the exercise price of our common stock of \$1.63 per share at the grant date based on our valuation as of February 28, 2010, described above.

However, we subsequently determined that a stock compensation charge should be calculated for the difference between the \$1.63 per share exercise price at the grant date and the estimated fair value of \$2.27 per common share at the grant date, based on the following:

- The issuance of Series E Convertible Preferred Stock at \$6.174 per share in March, April and May 2010, resulting in cash proceeds of \$45.7 million, and consideration of the voting, conversion, dividend, liquidation, and other rights and preferences of the preferred shares relative to those of the outstanding common shares;
- Substantial increase in the level of quarterly revenues from \$5.4 million in the three months ended September 30, 2009 to \$12.0 million and \$11.6 million in the three months ended December 31, 2009 and March 31, 2010, respectively, and a concurrent improvement in gross profit percentage over such periods;
- Revised increased forecasts for operating performance for 2010 and subsequent years; and
- Consideration of our valuation as of January 31, 2011, which estimated the value of our common stock at \$4.09 per share as of January 2011 (as discussed above); a retrospective straight-line extrapolation based on the fair value determined as of January 31, 2011 resulted in a revised estimated fair value of \$2.27 per common share as of the June 3, 2010 grant date.

As a result, additional compensation expense of \$264,000 related to the June 2010 grants will be recognized over the four year vesting period of the options.

January 2010. Our board of directors determined the exercise price of our common stock of \$0.64 per share at the grant date based on our valuation as of October 31, 2009, which estimated the value of our common stock at \$0.64 per share and included the following key assumptions:

- The business enterprise value based on a weighted income approach and market approach of \$49.9 million;
- Discount rate of 43% based on the calculated weighted average cost of capital;

[Table of Contents](#)

- Lack of marketability discount of 38% based upon an assumed time to a liquidity event to occur of approximately 2.5 years;
- Our financial condition and related need for additional working capital; and
- The sale of Series D Convertible Preferred Stock at \$2.134 per share in April and June 2009; resulting in cash proceeds of approximately \$24.2 million, and consideration of the voting, conversion, dividend, liquidation, and other rights and preferences of the preferred shares relative to those of the outstanding common shares.

Quantitative and Qualitative Disclosures about Market Risk

Concentrations of Credit Risk and Major Customers

We are potentially subject to financial instrument concentration of credit risk through our cash equivalents and trade accounts receivables. We place our cash and cash equivalents with major financial institutions that management assesses to be of high credit quality, to limit the exposure of each investment. Trade accounts receivables can be potentially exposed to a concentration of credit risk with our major customers. At December 31, 2011, we had amounts due from two customers that represented 24% and 10%, respectively, of the total accounts receivable balance. We currently do not foresee a credit risk associated with these receivables. As of December 31, 2010, our three largest accounts receivable balances represented 14%, 13% and 10% of the total accounts receivable balance. For the year ended December 31, 2011, three customers accounted for 17%, 11% and 10% of total net revenues. In 2010, two customers accounted for 14% and 11% of total net revenues. In 2009, three customers accounted for 19%, 10% and 10% of total net revenues.

Interest Rate Sensitivity

We had cash and cash equivalents of \$51.5 million, \$40.0 million and \$8.6 million at December 31, 2011, 2010 and 2009, respectively, which was held for working capital purposes. We do not enter into investments for trading or speculative purposes. Due to the short-term nature of these investments, we do not believe that we have any material exposure to changes in the fair value as a result of changes in interest rates. Declines in interest rates, however, will reduce future investment income. Interest income was not material for all periods presented. Our revolving line of credit agreement was the only instrument we held with variable interest rates which could, if drawn upon, subject us to risks associated with changes in interest rates. As of December 31, 2011 and 2010, there were no amounts outstanding under this line of credit. If the interest rate on our line of credit rose 10%, our results from operations and cash flows would not be materially affected.

Foreign Currency Exchange Risk

Through December 31, 2010, substantially all of our transactions were denominated in U.S. dollars. In 2011, we began to operate and conduct business in foreign countries where our foreign entities use the local currency as their respective functional currency and, as a result, are exposed to movements in foreign currency exchange rates. More specifically, we face foreign currency exposure from the effect of fluctuating exchange rates on payables and receivables relating to transactions that are denominated in Euros and the New Zealand Dollar. These payables and receivables primarily arise from sales to customers and intercompany transactions. We also face currency exposure that arises from translating the results of our European and New Zealand operations, including sales and marketing and research and development expenses, to the U.S. dollar at exchange rates that have fluctuated from the beginning of a reporting period. Our exposure to foreign currency exchange risk related to our foreign operations was not material to our results of operations, cash flows or financial position.

BUSINESS

Overview

We deliver microinverter technology for the solar industry that increases energy production, simplifies design and installation, improves system uptime and reliability, reduces fire safety risk and provides a platform for intelligent energy management. To date, the solar industry has relied on the traditional central inverter approach to power conversion that has largely remained unchanged for the past two decades. We have built from the ground up a semiconductor-based microinverter system that converts energy at the individual solar module level and, combined with our proprietary networking and software technologies, provides advanced energy monitoring and control. Given the significant advantages over traditional central inverters, we believe that microinverter solutions will become the standard for residential and commercial solar.

We are the market leader in the microinverter category and have grown rapidly since our first commercial shipment in mid-2008, with more than 1,700,000 units sold to date, representing over an estimated 42,000 solar installations. We were the first company to commercially ship microinverter systems in volume. Our products have been installed in all 50 U.S. states and eight Canadian provinces, and we are rapidly taking market share from traditional central inverter manufacturers. For example, in California and according to CSI, based on total wattage of installations, our market share of the <10kW residential solar photovoltaics, or PV, inverter market and the 10kW to 100kW small commercial solar PV inverter market has increased from 0% in July 2008 to 28.1% and 15.8%, respectively, based on the three month moving averages at the end of December 2011. According to a 2010 SEIA report, California was the largest single solar market in the United States accounting for over 30% of all solar installations.

California Residential and Small Commercial Market Share (July 2008 – December 2011)
 Enphase Energy Market Share – 3 Month Moving Average

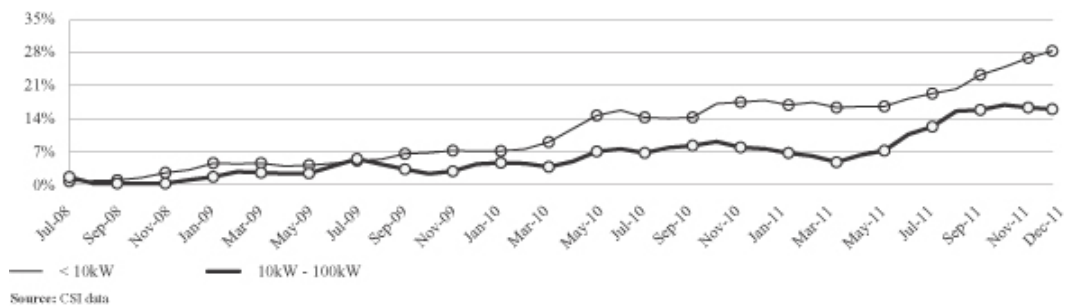

Our market share of the broader Americas market, based on total dollar sales volume across all inverter technologies and all installation sizes, had increased to 10.6% in 2010, according to IMS Research data.

Our microinverter solution brings a system-based, high technology approach to solar energy generation leveraging our design expertise across power electronics, semiconductors, networking and software technologies. Our microinverter system consists of three key components: the Enphase microinverter; the Envoy communications gateway; and the Enlighten web-based software:

- Our Enphase microinverter delivers efficient and reliable power conversion at the individual solar module level by introducing digital architecture that incorporates a custom ASIC, specialized power electronics devices and an embedded software subsystem that optimizes energy production from each module and manages the core ASIC functions. A residential solar installation consists of 5 to 50 microinverters; a small commercial solar installation consists of 50 to 500 microinverters.
- Our Envoy communications gateway is installed within the system owner’s home or business and serves as a networking hub that collects data from the microinverter array and sends the information to

[Table of Contents](#)

our hosted data center. One Envoy is typically sold with each solar installation and can support up to 100 Enphase microinverters.

- Our Enlighten web-based software collects and processes this information to enable system owners to monitor and analyze the performance of their solar PV system down to the individual solar module level. Enlighten also provides an online portal specifically designed for installers to enable them to track and manage all of their Enphase enabled projects. Historically, Enlighten service revenue has represented less than 1% of total revenues in each reporting period.

Together, our Enphase microinverter, Envoy communications gateway and Enlighten web-based software function as a single unified system that enhances energy production, simplifies design and installation, reduces costs, increases reliability and uptime, reduces fire risk, and provides the ability to monitor performance down to the module level in real-time compared to central inverter system. With an Enphase microinverter system, we believe system owners can achieve a higher return on investment over the lifetime of the solar system.

We sell our microinverter systems primarily to distributors who resell them to solar installers. Over 3,700 installers in North America have installed our microinverters through March 1, 2012, and this number is increasing by approximately 100 new installers per month. We also sell directly to large installers as well as through OEMs and strategic partners. We have achieved substantial growth since we commenced commercial production in 2008. The majority of our revenue has been generated by sales within the United States. Sales to customers in Canada commenced in 2009 and accounted for approximately 12% of our total net revenues in 2011. In early 2011 we established sales offices in France and Italy, and began selling into France, Italy and the Benelux region in the fourth quarter of 2011. Our total net revenues were \$20.2 million, \$61.7 million and \$149.5 million for fiscal years 2009, 2010, and 2011, respectively.

Industry Overview

Solar Energy Is a Large and Growing Industry

According to The Datamonitor Group, the global electricity market represented \$1.6 trillion in annual consumption in 2009. With global electricity needs expected to increase by approximately 45% from 2009 to 2035, according to the U.S. Department of Energy, coupled with increasing energy security and environmental concerns associated with traditional fossil fuels, suppliers and users of electricity are seeking more renewable sources of energy. Among renewable sources of electricity, solar energy has the most potential to meet the world's growing electricity needs. The global solar PV market witnessed rapid growth from 18 GW, or \$75.3 billion, of installed capacity coming online during 2010 to 25 GW, or \$86.3 billion, in 2011, and is expected to grow to 48 GW, or \$105.8 billion, in 2015, according to IHS iSuppli.

The solar PV market has grown in Europe, largely driven by subsidies that have been implemented by numerous countries to develop a renewable energy industry and create jobs at the local level. In Europe, these subsidies take the form of FiTs, which guarantee eligible renewable electricity generators a premium price for the electricity they produce over a long term time horizon. The U.S. solar PV market is growing rapidly, as there are both federal incentive programs for solar energy available such as the Business Energy Investment Tax Credits, as well state-level implementations of Renewable Portfolio Standards and other state, local and utility subsidies and other programs geared toward encouraging the development of solar energy. The U.S. solar PV market grew over 100% in 2010 over 2009 and is projected to become the largest solar PV market in the world by 2015 by number of annual installations as the price of solar approaches the price of other electricity sources on the grid. Nearly 1 GW, or \$5.1 billion, was installed in the United States in 2010, and the U.S. solar PV market is expected to grow to 6 GW, or \$16.4 billion by 2015 according to IHS iSuppli.

Smaller solar installations typically attract higher FiT rates as the costs are higher and installed by residential owners rather than financial investors. Recent changes to local FiT rules by governments in Italy,

Germany and Spain are favoring the smaller installations even more than before. As a result, growth in the global solar industry is expected to shift from utility-scale and commercial solar greenfield installations to residential and commercial rooftop solar installations.

Recent Market Developments

The solar PV installation market grew strongly in 2011 and new installations reached an estimated 25 GW, up 39% from 18 GW in 2010 according to IHS iSuppli. However, several European countries experienced a slowdown in new installations in 2011, as national governments revised solar tariffs and subsidies. This slowdown was offset by strong growth in other regions, including the United States. Given current budget difficulties, several governments are expected to revise solar tariffs and reduce support for solar PV installations in 2012. In addition, oversupply for solar modules and increasing competition from low cost Chinese module manufacturers weigh on the sector. Some of these challenges are expected to continue in 2012, with global solar PV installations expected to decline 7% to 23 GW, according to IHS iSuppli. Beyond 2012, growth is expected to remain robust with new solar installations expected to reach 48 GW by 2015, according to IHS iSuppli.

Solar Industry Segmentation

The solar PV market consists of two primary on-grid solar markets: distributed solar systems for residential and commercial buildings; and centralized large scale solar PV installations owned and operated by utilities. Residential deployments are typically small (<10 kW) roof-mounted installations to supplement power usage to residential dwellings. Commercial installations are small to large (>10 kW to 1 MW) deployments, typically also roof-mounted, to supplement electricity requirements of commercial buildings such as retail stores, apartment complexes, industrial manufacturing facilities and state and federally owned government office buildings. Utility-scale solar PV installations are very large (several MWs) PV arrays that are typically ground-mounted and located in remote regions that receive high solar irradiation, such as the American desert southwest region, and generate significant amounts of electricity that is transported by utility transmission lines to load centers. In 2010, the residential and commercial markets represented 72% of the U.S. solar inverter market, according to SEIA.

Typical Solar System Costs

There are four key components of the cost of installing a typical solar PV system: solar modules; installation; DC to AC inverters; and cabling and other. Solar modules represent 59% of the total cost. Installation represents 25% of the total cost and includes the costs of specialized solar installation and design professionals to construct the solar system at the home or business. The inverter represents 10% of the total cost and is used to transform the DC power generated by the solar module array to standard AC power used in homes and buildings. Finally, cabling and other represent 6% of the total cost and include wiring systems used to integrate the solar modules into the electrical systems. The wiring systems include disconnects for the DC side of the inverter, ground-fault protection, and over current protection for the solar modules.

Table of Contents

Breakdown of Total Solar System Costs % of Total System Cost

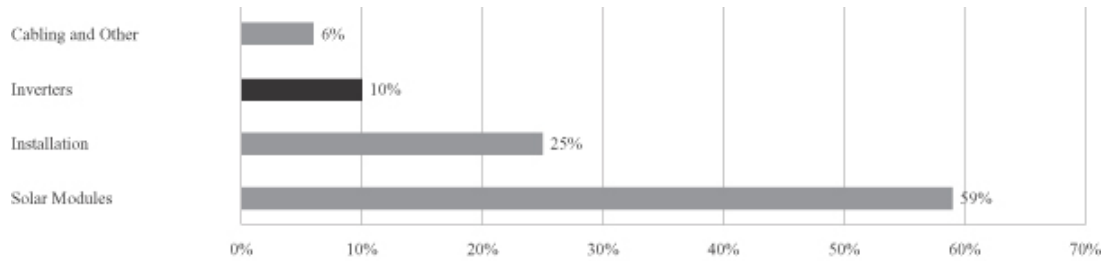

Source : iSuppli data

Inverter Industry

Historically, traditional central inverters have been the only inverter technology used for solar PV installations. In an installation consisting of a traditional central inverter, the solar PV modules are connected in series strings. In a large installation, there are multiple series strings connected in parallel. The aggregated voltage from each of these strings is then fed into a large central inverter. The central inverter performs two key functions: (i) it establishes a maximum power point tracking, or MPPT, operating point for the system and (ii) converts power from high-voltage DC to grid-complaint AC. Since the beginning of solar PV industry, traditional central inverters have continued to use high-voltage analog technologies to convert DC to AC requiring complex design and string calculations to ensure safe and reliable system operation. In 2010, 99% of the GW volume of solar inverters deployed were traditional central inverters. The worldwide market for inverter technology in 2011 was almost 27 GW, or \$6.8 billion, and the market is expected to grow to 46 GW, or \$10.1 billion, by 2015, according to IMS Research.

Traditional Central Inverter Architecture

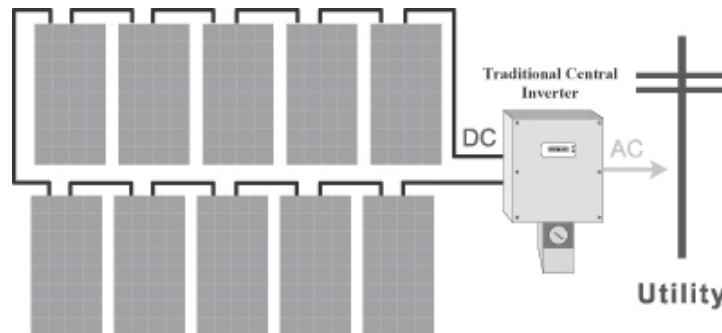

Challenges of Traditional Central Inverters

As compared to microinverter systems, we believe that traditional central inverters have a number of design and performance challenges limiting innovation and their ability to reduce the cost of solar systems, including the following:

- *Productivity limits.* If solar modules are wired using a traditional central inverter—such that a group or “string” of modules are wired in series—an entire string’s output is limited by the output of the lowest-performing module. If one module is dirty, shaded, or is not operating to its maximum specification, the whole string’s output is lowered to the level of that module resulting in a loss of energy production. In addition, due to string design requirements, central inverters also limit the design and site selection

for solar PV arrays, particularly in rooftop applications. As such, many of today's central inverter installations are not maximizing energy production and, therefore, the system owners are not realizing the full benefit of their investment.

- *Reliability issues.* Traditional central inverters are the single most common component of solar installations to fail, resulting in system downtime and adversely impacting total energy output. If a central inverter fails, the downtime is significant since the entire array will not be producing energy until the inverter is repaired or replaced. The high-DC voltage and power levels processed by central inverters result in higher inverter failure rates and shorter product life due to higher stress on components. As a result, central inverters typically carry warranties of only 5-10 years while solar modules have warranties of 25 years, potentially requiring several inverter repairs or replacements over the life of the solar PV system.
- *Complex design and installation requirements.* The central inverter-based solar PV installation requires greater effort on the part of the installer, both in terms of design and on-site labor. Central inverter installations require string design and calculations for safe and reliable operation, as well as specialized equipment such as DC combiners, conduits and disconnects. In addition, the use of high-voltage DC requires specialized knowledge and training and safety precautions to install central inverter technology. Installers must also know and inventory a family of inverters to manage different solar PV installation sizes. Once installed, the system is not expandable without a purchase of another central inverter. Central inverters also tend to be heavy, bulky and noisy and often have to be protected and located outside of plain view.
- *Lack of monitoring.* The majority of solar installations with central inverter technology offer limited monitoring capabilities. A failure of the central inverter will often go unnoticed for days or even weeks. Even if some form of monitoring is available, it is limited to the inverter and cannot monitor the health and performance of individual solar modules. Therefore, if a module fails or is not performing to specification, the resulting loss of energy can go unnoticed.
- *Safety issues.* Central inverter solar PV installations have a wide distribution of high-voltage DC wiring. If damaged, DC wires can generate sustained electrical arcs, reaching temperatures of more than 5,000 °F. This creates the risk of fire for solar PV installation owners and injury for installers and maintenance personnel. In fact, due to an increasing number of incidents, the 2011 National Electric Code now requires all inverters to be able to detect and interrupt DC arc faults.

These challenges of traditional central inverters have a direct impact on the cost and expected return on investment of solar installations to both installers and system owners:

- *Installer.* Solar system installers aim for simple installation design, fast installation times and maximum system performance and predictability. The installation of high-voltage DC central inverter technology, however, requires significant preparation, precautionary safety measures, time-consuming string calculations, extensive design expertise and specialized installation equipment, training and knowledge. Together, these factors significantly increase complexity and cost of installation and limit overall productivity for the installer.
- *System owner.* Solar system owners aim for high energy production, low cost, high reliability and low maintenance requirements, as well as reducing fire risks. With central inverter solutions, owners often are unable to optimize the size or shape of their solar PV installations due to string design limitations, experience performance loss from shading and other obstructions, can face frequent system failures and lack the ability to effectively monitor the performance of their solar PV installation. In addition, central inverter installations operate at high-voltage DC which bears significant fire risks. Further, central inverter installations can affect architectural aesthetics of the house or commercial building.

Our Solution

We design, develop, manufacture and sell the leading microinverter system for the solar PV industry. To date the solar industry has relied on the traditional central inverter approach that has largely remained unchanged for the past two decades. We have built from the ground up a semiconductor-based microinverter system that converts energy at the individual solar module level and, combined with our proprietary networking and software technologies, provides advanced energy monitoring and control. This is vastly different than the central inverter approach that can only convert energy of the entire array of solar modules from a single high voltage electrical unit, and lacks intelligence about the energy producing capacity of the solar array. The different approaches are depicted in the figure below.

Traditional Central Inverter System vs. Microinverter System

Traditional Central Inverter Approach

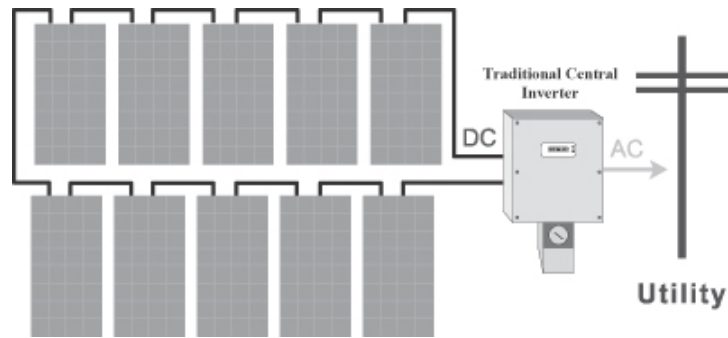

Enphase Microinverter System

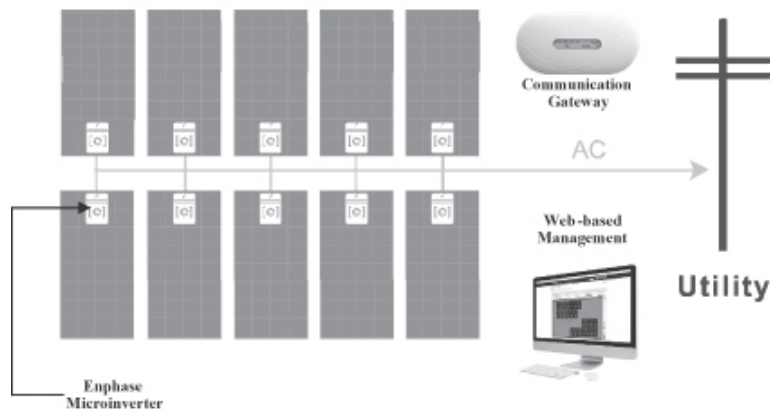

Our microinverter solution brings a system-based, high technology approach to solar energy generation leveraging our design expertise across power electronics, semiconductors, networking, and embedded and web-based software technologies. Our microinverter system consists of the following hardware and service components: our Enphase microinverter; our Envoy communications gateway; and our Enlighten web-based software service. Since inception approximately 99% of our net revenues have been derived from the sale of hardware products.

[Table of Contents](#)

- Our Enphase microinverter delivers efficient and reliable power conversion at the individual solar module level by introducing a digital architecture that incorporates custom ASICs, specialized power electronics devices and an embedded software subsystem that optimizes energy production from each module and manages the core ASIC functions. A residential solar installation consists of 5 to 50 microinverters; a small commercial solar installation consists of 50 to 500 microinverters.
- Our Envoy communications gateway is installed within the system owner's home or business and serves as a networking hub that collects data from the microinverter array and sends the information to our hosted data center. One Envoy is typically sold with each solar installation and can support up to 100 Enphase microinverters.
- Our Enlighten web-based software collects and processes this information to enable system owners to monitor and analyze the performance of their solar PV system at the individual solar module level. Enlighten also provides an online portal specifically designed for installers to enable them to track and manage all of their Enphase enabled projects and monitor and analyze the performance of their systems. Historically, Enlighten service revenue has represented less than 1% of total revenues in any given reporting period.

Together, our Enphase microinverter, Envoy communications gateway and Enlighten web-based software function as a single unified system that enhances energy production, simplifies design and installation, reduces costs, increases system uptime and reliability, reduces fire safety risk, and provides the ability to monitor performance at the individual module level in real-time. With an Enphase microinverter system, we believe solar system owners can achieve a higher return on investment over the lifetime of the solar system than would be achieved using a traditional central inverter approach.

Key elements of our solution include:

- *Productive—Superior Energy Production.* Our microinverter system enables the maximum possible energy production from each module, overcoming a fundamental design limitation of central inverters which are limited by the lowest performing module. We believe that our microinverter systems achieve higher energy production and can generate superior returns on investment relative to central inverter solutions for system owners.
- *Reliable—Longer Life and No Single Point of Failure.* Reduction of component count, primarily through semiconductor integration in our microinverter, allows us to design a reliable system that can withstand harsh environmental conditions. In addition, because we process low voltages and power levels, our components experience less stress and last longer than traditional central inverters. Furthermore, the distributed architecture of our microinverter system improves system uptime. If a microinverter unit fails, it results in lost energy production from a single solar module only and not the entire array. We estimate that our microinverter systems achieve system uptimes of over 99.8%. Enphase microinverters are fully certified and comply with certain electrical standards, such as UL 1741 of the National Electrical Code standard, or NEC, and safety standards, such as CSA in Canada or UL in the United States. We offer a 25-year limited warranty on our latest generation microinverter and 100% system uptime guarantee.
- *Simple—Ease of Design and Installation.* Using microinverter technology, an installer can design a system of any size and any roof configuration with a simple modular approach. After initial installation, the system can be easily expanded by even a single module. Our single inverter per module approach converts directly to AC and enables a simpler, all AC design, eliminating the extra cost, training and complexity associated with typical high voltage DC implementation. Without these complexities, installation of microinverter technology is greatly simplified, improving installers' productivity. This also enables a new class of solar installer, such as electricians and general contractors. Finally, our microinverters are installed on the roof and hidden from view, with minimal impact to the aesthetics of a home or building.

[Table of Contents](#)

- *Smart—Module-Level Monitoring and Analytics.* Our microinverter system allows us to collect energy production information in real time on a per solar module basis. This enables powerful system analytics and allows Enphase to offer installers and system owners visibility into how their system is performing and the ability to continuously optimize energy production—which is particularly important when operating commercial solar installations. Such services include system performance and diagnostics, benchmarking, as well as system and module alerts and fault statistics.
- *Safe—“All AC” Solution.* Perhaps most important to both installers and system owners, microinverters are safer because they process low DC voltages relative to central inverters. High voltage arc faults associated with traditional central inverter are the leading cause of fires of solar PV installations. Microinverter technology mitigates this safety risk.

Due to the benefits of our solution, we believe solar installers achieve greater productivity and competitive differentiation over installers of traditional central inverter solar PV installations, and the solar system owner achieves a higher return on investment with an Enphase microinverter system over the life of the solar system.

LCOE Case Studies

The levelized cost of energy, or LCOE, case studies selected represent residential (<10kW) and small commercial (10-100kW) solar energy systems, and we believe the LCOE results are typical of the system sizes represented. Each case study represents an actual Enphase installation.

Upfront System Costs

Each case study identifies four primary cost areas:

- *Modules and Racking*—The modules and racking line item includes the cost of the solar modules and the racking and labor to construct the solar module array. These costs are generally consistent for either inverter type. We estimated the solar module costs at the time of installation, and they represent about 40% of the total upfront system cost. We estimated the racking and solar module array construction costs using an industry guideline of roughly \$1 per Watt, or approximately 20% of the total upfront system cost. Together, these costs account for roughly 60% of the total upfront system cost.
- *Inverter*—The inverter line item includes the cost of the inverters (either microinverters or traditional central inverters) and the electrical system and labor to install them. The inverter alone represents about 10% of the total upfront system cost and the electrical system and labor costs represent an additional 5% of the total upfront system cost. We estimated the traditional central inverter, microinverter, electrical system and labor costs at the time of installation.
- *Design, Permit and Other*—The design, permit and other costs include the cost to design and permit the solar energy system. We estimated these costs which represent 3-4% of the total upfront system cost. In general, we believe that traditional central inverter-based systems are more complex and require more design time, resources and expertise.
- *Profit and Sales Tax*—We estimated the profit mark-up and sales tax, which together represent about 22% of the total upfront system cost.

The total upfront system cost includes each of the costs listed above. The total upfront system cost is represented both in absolute dollars and on a dollar per watt basis in each case study table presented below. These costs exclude any available federal or state rebates and incentives for both the microinverter and central inverter figures.

LCOE and IRR

We determined the financial return of each system using LCOE and IRR analyses. Both analyses incorporate the savings in electricity costs offset by solar energy production, in addition to rebates and incentives.

[Table of Contents](#)

Energy Harvest—Additional “energy harvest” refers to the additional energy production that would be achieved by an Enphase microinverter system, as compared to the estimated energy production of a traditional central inverter for an installation of a similar size, as a result of the microinverter system’s ability to convert energy at the individual solar module level. We calculated estimated energy production by using PVWatts, an online calculation tool developed by the National Renewable Energy Laboratory and used by solar industry participants, to estimate the energy production of grid connected PV systems at locations around the world. Then we applied a 5-6% increase in energy production to the Enphase system to account for the additional energy harvest expected by the microinverter system. In both case studies, the actual energy production results reported from Enlighten, our web-based monitoring system, are trending at or higher than predicted in the case studies, except for a brief period during which the residential installation was covered in snow and was not operational.

System Uptime—System uptime impacts solar energy production and therefore the total lifetime cost of the system. The 98% system uptime for a traditional central inverter-based installation is the PVWatts default value, and the cost of an out of warranty central inverter replacement was factored in year 11. We estimated the uptime of the installed Enphase microinverter systems to be 99.8% based on an estimated failure rate of 0.3% for Enphase microinverter units, which we calculated based upon our analysis of the mean time between failure, or MTBF, of the Enphase microinverter units, and an assumed inverter replacement within 6 months of failure. We factored the cost of out of warranty microinverter replacements in years 16-20.

LCOE and IRR—LCOE represents the ratio of the total lifetime cost of the system, which is the sum of the total upfront system cost plus the present value of the total lifetime cost of the system, to its total lifetime energy output. Because of its additional energy harvest, the Enphase system provides a higher cumulative energy production and a lower LCOE. IRR represents the annualized effective compounded return rate or discount rate that makes the net present value of all cash flows (both positive and negative) from the solar installations equal to zero. The IRR figures in the case studies are based on the cash flows (both positive and negative) from the perspective of the system owner. The Enphase system offers a higher IRR because the higher cumulative energy production results in a higher effective rate of return.

Residential Installation

The solar installation illustrated below represents a typical residential solar installation employing either a traditional central inverter approach or an Enphase microinverter system. The residence is in Ontario, Canada and experiences moderate sunshine. It has a standard roof line with two arrays, maximizing the number of solar panels and achieving the desired 7.5 kW DC system size. Some shading exists, but did not factor significantly in determining whether to use a traditional central inverter or an Enphase microinverter system over a traditional central inverter.

Residential Installation with an 7.5 kW DC System⁽¹⁾⁽²⁾



IRR/LCOE Comparison

	Enphase Microinverter	Traditional Central Inverter
Total Upfront System Cost⁽³⁾	\$43,364	\$41,838
Modules and Racking ⁽⁴⁾	\$25,500	\$25,500
Inverter ⁽⁵⁾	\$6,650	\$5,270
Design, Permit and Other	\$1,400	\$1,600
Profit and Sales Tax	\$9,814	\$9,468
California Energy Commission (CEC) Efficiency	95%	96%
System Uptime	99.8%	98%
Inverter Warranty	15 years	10 years
Additional Energy Harvest	5%	N/A
\$/Watt DC (Total System Cost)	\$5.78	\$5.58
LCOE⁽²⁾⁽⁶⁾⁽⁷⁾	\$0.18/kWh	\$0.19/kWh
IRR⁽²⁾⁽⁶⁾⁽⁷⁾	9.4%	8.4%

Source: Enphase estimates based on 7.5 kW DC system size

Note: (1) = Date of installation: December 11, 2010.

(2) = PVWatts estimated first full year energy production: 9,800 kWh (Enphase); 9,300 kWh (central).

(3) = Cost is to the system owner.

(4) = Solar module size: 230W DC; number of modules: 33; cost per module: \$550. Module and racking costs include labor.

(5) = Inverter size and cost: 190W AC, \$163 (Enphase); 8kW DC, \$3,300 (central). Inverter costs include inverter, cabling and monitoring equipment, and labor.

(6) = Electricity rate: \$.25/kWh with a 5% per year increase.

(7) = Assumes 20-year life. Includes incentives and rebates.

The Enphase microinverter system compares favorably to a traditional central inverter system even on a total upfront system cost basis (<4% premium for the Enphase system). For installers, the ease of installation, all AC system design and improved energy production more than compensates for the small upfront cost premium.

Small Commercial Installation

The 53.5 kW DC small commercial solar installation illustrated below consists of 228 solar modules. The building is in Arizona and experiences high sunshine. Some of the solar modules experience some shade from a small center tower visible in the picture. A single traditional central inverter system was also proposed as an alternative. The curved roof presented challenges for a central inverter requiring more complicated string design and sizing which increased the design time and cost. Because of the size of the installation, the central inverter required additional equipment to aggregate cable runs from multiple DC strings.

Small Commercial Installation with a 53.5 kW DC System⁽¹⁾⁽²⁾

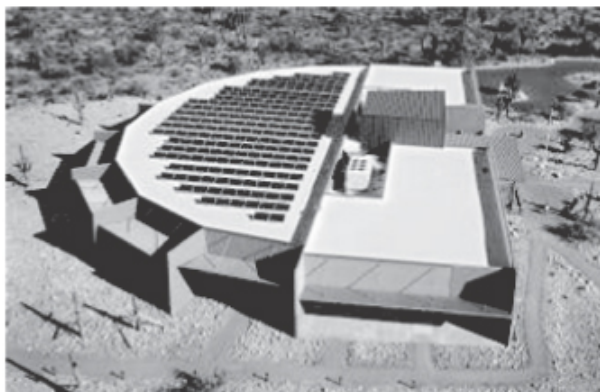

Photo by Tom Stacks

IRR/LCOE Comparison

	Enphase Microinverter	Traditional Central Inverter
Total Upfront System Cost⁽³⁾	\$267,758	\$259,766
Modules and Racking ⁽⁴⁾	\$155,150	\$155,150
Inverter ⁽⁵⁾	\$46,013	\$36,830
Design, Permit and Other	\$6,000	\$9,000
Profit and Sales Tax	\$60,595	\$58,786
CEC Efficiency	95%	96%
System Uptime	99.8%	98%
Inverter Warranty	15 years	10 years
Additional Energy Harvest	6%	N/A
\$/Watt DC (Total System Cost)	\$5.00	\$4.86
LCOE⁽²⁾⁽⁶⁾⁽⁷⁾	\$0.11/kWh	\$0.13/kWh
IRR⁽²⁾⁽⁶⁾⁽⁷⁾	16.8%	15.4%

Source: Enphase estimates based on 53.5 kW DC system size

Note: (1) = Date of installation: October 2, 2010.

(2) = PVWatts estimated first full year energy production: 9,270 kWh (Enphase); 8,680 kWh (central).

(3) = Cost is to the system owner.

(4) = Solar module size: 230W DC; number of modules: 228; cost per module: \$480. Module and racking costs include labor.

(5) = Inverter size and cost: 190W AC, \$163 (Enphase); 53.5kW DC, \$23,500 (central). Inverter costs include inverter, cabling and monitoring equipment, and labor.

(6) = Electricity rate: \$.25/kWh with a 5% per year increase.

(7) = Assumes a 20-year life. Includes incentives and rebates.

The Enphase microinverter system, while more costly upfront, was simpler to design and did not require additional equipment. It also achieved the specific aesthetic goals of the building owner. Furthermore, the solar installation is monitored and a kiosk in the building lobby displays the Enlighten web-based monitoring system.

Competitive Strengths

We believe the following combination of capabilities and features of our business model distinguish us from our competitors and position us well to capitalize on the expected growth in the solar market and to become a global leader in the broader solar power industry:

- *Market Leader and Rapid Adoption.* We are the market leader in the microinverter product category, have developed strong brand recognition and offer a proven microinverter solution. Since the shipment of the first commercial product in 2008, we have successfully introduced three microinverter generations, raising average conversion efficiency from 94% to 96%, power from 175 to 215 watts, and have over 1,700,000 units sold to date. We believe that our proven ability to innovate quickly will continue to allow us to build on our leading market position, and expand our product portfolio and market reach.
- *System Approach.* We built our solution from the ground up and employ a system approach with a powerful combination of digital electronics, networking and software technologies. Our system offers significant design and operating benefits beyond the core power conversion functionality underlying our microinverter. By integrating the Enphase microinverter technology with Envoy, our proprietary communications gateway, and our Enlighten web-based software, we deliver real-time module-level monitoring and analytics. As of March 1, 2012, our R&D organization included 99 engineers and is divided equally across critical power electronics and semiconductor, powerline communication and networking, and software design disciplines.
- *Strong Focus on Technology and Research and Development.* Our proximity to Silicon Valley and the past experience of our founders and executive officers in the technology industry have enabled us to recruit engineers with strong skills in power electronics, semiconductors, Powerline communications and networking, and software design, which we have complemented with significant solar industry expertise from other members of our team. We have a strong research and development team and a portfolio of intellectual property, or IP, spanning across the previously mentioned technology areas. As of March 1, 2012, we had 15 issued U.S. patents, two issued non-U.S. patents, 52 pending U.S. patent applications and 111 pending non-U.S. counterpart patent applications. We believe our combination of engineering, management and operational expertise from the high technology and the solar industry will help us to continue to rapidly innovate and cost efficiently introduce new microinverter solutions.
- *Field-Proven Reliability.* With over 1,700,000 of our microinverter units sold to date, our microinverters have established significantly improved reliability relative to traditional central inverter technology. Based on data from a sample of 2009 and 2010 North American residential and small commercial installations, Westinghouse Solar indicates that our microinverters have a failure rate of 0.207% compared to a significantly higher failure rate of 9.43% for traditional central inverters. We use proven technologies and design techniques to achieve higher reliability. In addition, we have designed and developed proprietary product verification test software and equipment and, as of March 1, 2012 employed a team of 36 engineers that ensures product quality and long-term reliability. As the result of ongoing advances in our microinverter system technology, we are confident enough in our product to offer our latest-generation microinverter product with a 25-year limited warranty consistent with the expected life of the solar PV installations.
- *Capital Efficient and Scalable Manufacturing.* Our design and R&D philosophy leads to a product design that enables us to employ a manufacturing model that we believe is superior to that of central inverter manufacturers. Our digital architecture allows us to leverage semiconductor integration to reduce part count in a microinverter unit, which we believe will allow us to significantly reduce manufacturing costs. Our microinverter is built on a single PC board allowing for a greater degree of automation in the manufacturing process and further reducing manufacturing cost. In contrast, traditional central inverters have multiple PC boards and complex internal wiring requiring a greater amount of manual construction and thereby increasing the cost of manufacturing. We outsource all of our hardware manufacturing to manufacturing partners, including Flextronics. Our model results in a

low fixed-cost structure and reduced capital expenditure and working capital requirements. In addition, our model provides greater flexibility to take advantage of market opportunities. For example, we recently expanded manufacturing to Canada to qualify for local content-based incentives and did so in less than three months with minimal capital expenditure. By expanding our production volume, we believe we can take advantage of economies of scale, enabling further reductions in the price per watt of our microinverter systems.

- *Rapidly Expanding Distribution Channels.* We sold our first microinverter system in 2008. Over 3,700 installers in North America have installed our microinverters through March 1, 2012, and this number is increasing by approximately 100 installers per month. Our microinverter technology is enabling new channels and routes to market, including through opening new and larger distribution channels. For example, we have a supply and distribution agreement with Siemens Industry, Inc. to re-sell co-branded Enphase microinverter products and related solutions through Siemens' network of over 50,000 North American electrical contractors. Our agreement with Siemens extends until January 31, 2014 and is terminable by either party upon one-year prior notice. To date, our agreement with Siemens has yet to generate any material revenue.
- *Intense Focus on Customer Service for Installers.* We believe we have cultivated an organizational focus on installer satisfaction that differentiates us from central inverter manufacturers, resulting in a high level of installer retention and "repeat" business. We work very closely with our installers to provide assistance necessary to help them across every aspect of the design and installation process. We provide full-day in-person training and online training to approximately 3,000 installers per year. Our system allows us to remotely design, activate, update, monitor and troubleshoot all of our connected solar installations and analyze energy production trends, enabling higher levels of customer satisfaction.

We believe these competitive strengths will enable us to maintain our leadership position as the residential and commercial solar market shifts from traditional central inverter to microinverter technology, and central and new players enter this market.

Our Strategy

Our objective is to continue to be the leading provider of microinverter systems for the solar industry worldwide and to accelerate the shift from traditional central inverters to microinverter technology. Key elements of our strategy include:

- *Continue to Penetrate Our Core Markets.* We intend to capitalize on our market leadership in the microinverter category and our growing momentum with installers and owners to further our market share position in our core markets in the United States and Canada. We currently focus our product offering for application in the residential and commercial markets. We plan to expand our sales and marketing and customer service efforts to increase our installer base and, in addition, extend enhanced field engineering capabilities to several larger direct commercial solar installers. In addition, our microinverter technology enables new entrants to become solar installers with minimal training. A majority of our installers are new to the solar industry and are installing solar modules for the first time. We intend to continue to bring new installers to the solar industry and expand our installer base.
- *Enter New Geographic Markets Rapidly.* We intend to expand into new markets with new products and local go-to-market capabilities. In early 2011, we established sales offices in France and Italy, and began selling into France, Italy and the Benelux region in the fourth quarter of 2011. We have established a representative office in China to support local solar module partners, and to develop the residential and commercial solar opportunity for microinverter systems in Asia. We opened our new offices to enable us to diversify our customer base, gain market share in worldwide solar markets and reduce our geographic dependence, and enable us to become a global microinverter vendor with global market reach.

[Table of Contents](#)

- *Increase Power and Efficiency and Reduce Cost per Watt.* Our engineering team is focused on continuing to increase average power conversion efficiency above 96% and AC output power beyond 215 watts. We intend to continue to leverage our semiconductor integration, power electronics expertise and manufacturing economies of scale to further reduce cost per watt. For example, our M215 Series microinverter is based on our next generation ASIC, which increases semiconductor content and integration of components, while at the same time lowering manufacturing costs and increasing conversion efficiency and reliability, improving the overall return on investment of the solar installation. We believe we are on a steeper cost per watt reduction curve relative to central inverters, enabling us to further penetrate the market.
- *Extend Our Technological Innovation.* We distinguish ourselves from other inverter companies with our system-based and high-tech approach, and the ability to leverage strong research and development capabilities. As of March 1, 2012, we had 15 issued U.S. patents, two issued non-U.S. patents, 52 pending U.S. patent applications and 111 pending non-U.S. counterpart patent applications. Ten of our issued U.S. patents directly relate to DC to AC power conversion for alternative energy power systems. The remaining five cover anti-islanding safety technology, measurement of grid voltage and monitoring circuits coupled to AC lines, respectively. Our design capabilities have allowed us to successively increase efficiency, power output and reliability, while reducing the cost per watt of our microinverter solution. As of March 1, 2012, we employed 99 engineers focused on design and development of our microinverter system and a dedicated group of power-electronics engineers employing proprietary system-modeling and simulation tools and specifying new components in advance of our next generation architecture. Further, we are working on a variant of our current-generation microinverter that enables an “AC module” for direct attachment of the microinverter to the backsheet of the solar modules, which further reduces installation cost and time, and we are developing our fourth-generation product designed to lower costs and facilitate our expansion strategy into large commercial solar installations and new geographies.
- *Expand Our Product Offering for Larger Commercial and Utility-Scale Installations.* We intend to expand our product offering by introducing new microinverter systems targeted at larger commercial and utility-scale installations. We expect these market segments to become a significant revenue opportunity for Enphase in the future. We also have programs in place focused on expanding our Enlighten web-based software platform and our networking capabilities for commercial and utility-scale installations.
- *Develop a Smart Energy Management Platform.* We intend to build upon our strong position as the leading supplier of microinverter and energy management systems to expand beyond solar and to create a smart energy management platform for integrated smart energy devices and services. For example, our smart thermostat device integrates with the Enlighten web-based software, allowing owners to manage their solar PV installations and control their heating and cooling system from a single web-based platform. We see opportunities beyond the thermostat and intend to develop additional energy management devices and services in the area of energy consumption monitoring and enable the growing network of solar installers to become energy consultants and service providers.

Our Products

Our microinverter system consists of three individual product components: our Enphase microinverter, Envoy communications gateway and Enlighten web-based software. These elements function as a single unified system that enhances energy production, simplifies design and installation, reduces costs, increases system uptime and reliability, reduces fire safety risk, and provides the ability to monitor performance down to the module level in real-time. Each of these elements and the specific products in our offering are displayed and described below:

Enphase System



1. Enphase Microinverter

- Maximizes energy production
- Installed on the racking beneath each solar module

2. Envoy Communications Gateway

- Monitors each module and microinverter in the array
- Connects to Enlighten servers through standard Internet router

3. Enlighten Software

- Continuously analyzes and reports the health and performance of the solar array
- Allows for remote system analysis and troubleshooting

Source: Enphase Energy

Enphase Microinverter

Our microinverter converts the DC output from a single solar module into grid compliant AC. It delivers efficient and reliable power conversion at the individual solar module level through a purpose built digital architecture that incorporates custom ASICs, specialized power electronics devices, custom magnetics, powerline communications, or PLC, and networking technology and an embedded software subsystem that optimizes energy production from each module and manages the core ASIC functions. We offer two microinverter product lines today:

- *Second Generation Microinverter.* Our second generation microinverter, including the M190, M210 and a twin pack version of the M190, the D380, has an average power conversion efficiency of 95%. It supports mono- and multi-crystalline solar modules from over 50 module vendors in 60-cell and 72-cell formats with nameplate power ratings of up to 240W STC. The maximum circuit size for this product is up to 15 microinverters. Each circuit is terminated directly to the AC load center using standard AC cabling. The microinverter is certified to UL1741 as a utility-interactive inverter, the U.S. and Canadian standard for static inverters and charge controllers for use in solar PV power systems, listed for sale in North America. We provide a 15-year limited warranty for our M190, M210 and D380 series microinverters.
- *Third Generation Microinverter.* Our third generation microinverter, the M215, is based on our next generation ASIC and increases the maximum rated AC output power to 215W, with average power conversion efficiency of 96%. Our M215 microinverter addresses 60-cell solar modules with nameplate power ratings of up to 260W STC. In addition, it incorporates a new, proprietary AC cable that

[Table of Contents](#)

increases the compatible system circuit size to up to 17 microinverters, allowing for greater installation flexibility and simplified cabling on the microinverter unit itself, reducing both cost and size. In addition to receiving UL1741 certification, it has also received the European VDE and CE certifications for sale in Europe. We offer a 25-year limited warranty for our M215 series microinverter.

Both our M190 and M215 series microinverters are installed on the roof and hidden from view, with minimal impact on the aesthetics of a home or building.

We support our microinverters with our Entrust program, which provides system owners with a 100% uptime guarantee. Under the Entrust program, we reimburse the system owner for any lost energy for up to one month if a microinverter unit should fail. In addition to replacing a microinverter unit under warranty, we proactively notify the installer, and ship an advance replacement unit free of charge.

Envoy Communications Gateway

Our Envoy communications gateway is the networking hub for the microinverter array. It collects data from the solar module via our proprietary PLC technology and delivers it to our hosted, Enlighten web-based software application through an Ethernet connection to a broadband Internet router. The Envoy communication gateway can also provide critical information if no broadband connection is available through its imbedded web interface that provides configuration, control and system state information and is accessible by computer through an Ethernet connection and through its LCD display that provides high level status information. In addition, the Envoy communications gateway supports Zigbee, a low power wireless mesh communication protocol for communication with our Environ smart thermostat.

Enlighten Software

Installers and system owners use our Enlighten web-based software, which is included with the Envoy communications gateway, to track and display daily, weekly and annual energy production information. Installers also use the Enlighten installer dashboard to manage multiple systems from a single screen. In addition, we use Enlighten to activate a system and remotely troubleshoot, analyze and diagnose system problems. System owners and installers access our Enlighten web-based software through the following interfaces:

- *Enlighten Monitoring Service.* The Enlighten web-based monitoring service provides real-time information to the installer and system owner on the energy production of the solar array. This service can be accessed by installers or system owners from any personal computer or a mobile device with a web browser.
- *Installer Dashboard.* The installer dashboard is a web-based portal that is the first page each installer sees when he accesses his Enlighten account. It allows an Enphase installer to easily customize the page so several sites under management can be consolidated into a single view. In addition, we use the installer dashboard to communicate with our installers, with industry news, product updates and Enphase community postings.

Environ Smart Thermostat

Our Environ smart thermostat enables system owners to monitor and control heating and cooling of a home or business. This smart thermostat integrates with our Envoy communications gateway and our Enlighten web-based software. Users can control the temperature of their homes from anywhere they have access to a web browser, including a mobile device.

Our Technology

Three years after the introduction of our first generation microinverter system, we have successfully commercialized the technology, creating a new product category. Our system has the following critical attributes:

- Converts DC power from the solar module into grid-compliant AC power efficiently and with minimal loss;
- Achieves low cost per watt and LCOE;
- Provides a robust communications network enabling real-time management of the solar PV installation;
- Ensures a high level of safety both during and after installation;
- Connects to the grid safely and to specification;
- Ensures long-term durability in harsh outdoor environments; and
- Manufacturable in high volumes and at high yields.

The critical technologies enabling our system are in the areas of power electronics and magnetics, semiconductors, powerline communications and networking, and embedded and web-based software. An overview of each of these technology elements and the essential function each play in the overall microinverter system is described below:

Enphase Microinverter

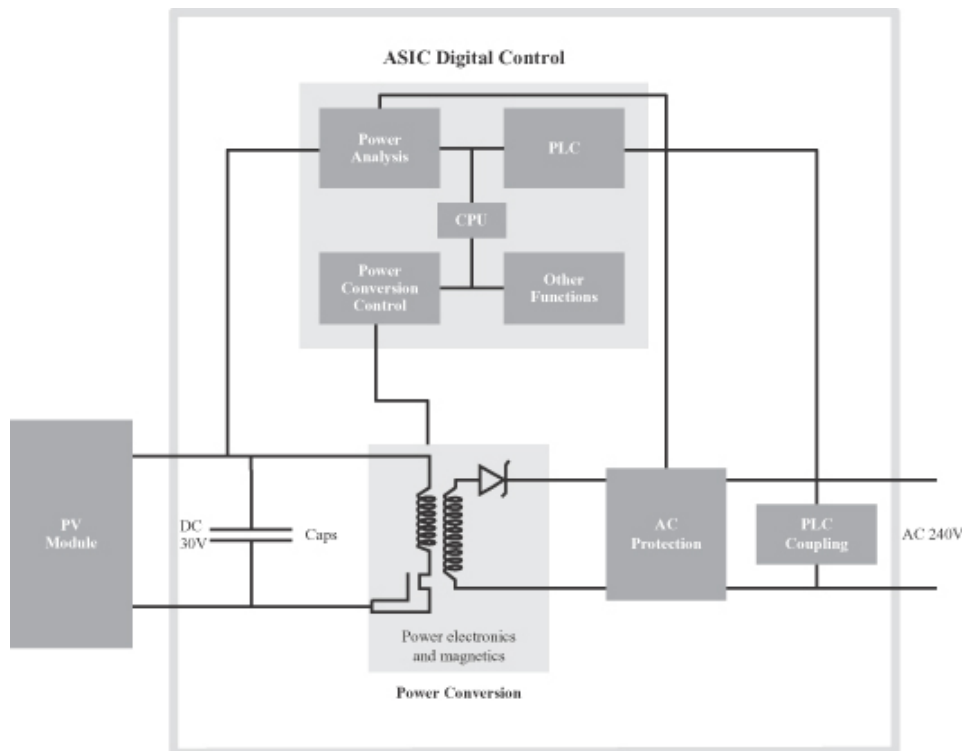

Source: Enphase Energy

Power Electronics

The performance and efficiency of our Enphase microinverter is driven by its core architecture and design. Key functions of the design include specialized power electronics, custom magnetics and advanced ASIC-based digital control that enable our Enphase microinverter to efficiently convert DC from the solar module to grid-compliant AC at optimal efficiency. Our Enphase microinverters utilize a sophisticated predictive model to accomplish this conversion and output a digitally synthesized AC waveform. Our Enphase microinverter conforms to safety standards as defined by UL1741 in North America and VDE0126 in Europe. Our microinverters also analyze both the DC and AC electrical characteristics of the system to determine safe and reliable operation.

We also utilize proprietary simulation and validation tools capable of modeling most elements of our hardware solution to accurately predict performance prior to hardware design and fabrication or, alternately, to identify and optimize critical design parameters. We use these simulation and validation capabilities to develop new and more sophisticated control algorithms, and to reduce our engineering investments and time to market.

Magnetics

Microinverter power conversion efficiency, cost and reliability are a function of the magnetics designed in the system. We design and utilize custom magnetic cores and windings to maximize the power density of a chosen magnetics core geometry, which in addition to high performance and low cost allows us to achieve improved thermal performance, reliability and a very low mechanical profile, an important criteria for mounting underneath or onto a solar module. We work to optimize pin spacing and other electrical properties to ensure we meet stringent regulatory requirements for electromagnetic emission.

Semiconductors

Unlike early microinverter technology or current central inverters, the Enphase microinverter is a microelectronics device built around a digital architecture. Around 30% of the bill of materials of each Enphase microinverter is composed of semiconductor content. We are on our fifth generation of ASICs responsible for all critical digital control functions of our microinverter, including detailed power analysis, digital control of the power conversion subsystem and powerline communications and networking. Unlike traditional inverters, our microinverters process low amounts of power (215W AC) and switch low DC voltages (30 volts DC). These features, combined with the ability to leverage low cost silicon in standard packages and pin counts, make possible a high degree of semiconductor integration. As a result, much of the functionality of our Enphase microinverter can be integrated into a standard CMOS ASIC instead of discrete electrical components, resulting in lower costs and a simplified overall hardware design. Our intent is to leverage semiconductor integration in the solar industry in the same fashion that semiconductors benefited the personal computer, telecommunications and consumer electronics industries, delivering more functionality and lower costs.

Our ASIC performs the critical power analysis and power conversion control functions of the microinverter. The power analysis function processes critical sensory input from the solar module and the AC grid, such as voltage and frequency and other information that enables the precise control of the synthesized output AC waveform. Our ASIC also provides the advanced digital control and state machine logic that controls the power conversion function. A high speed power sequencer that controls the transfer of energy from the DC side of the system to the AC side at very high frequency drives the power metal-oxide-semiconductor field-effect transistors, or MOSFETs, in our microinverter. In addition, our digital control system uses an innovative predictive control technology that allows the solar PV installation to anticipate and adapt to changing operating conditions and protect against grid anomalies, such as power surges.

Powerline Communications and Networking

A powerline communications networking link exists between each microinverter in the array and the Envoy gateway. Our powerline communications link uses a proprietary networking technology developed by Enphase utilizing the same AC wiring to transmit and receive data between devices as is used to distribute electricity.

[Table of Contents](#)

Our proprietary PLC technology is integrated into our custom ASIC. Our third generation microinverter, the M215, integrates our most advanced PLC technology, which offers improved modulation techniques and additional carrier frequencies to enhance performance. In addition, it increases the number of devices supported through more powerful data processing capabilities, and extends the range supported between devices with superior signal processing. Finally, it provides reduced communications latency with more frequent polling of end devices and improved link reliability through advanced error detection and correction.

An Enphase powerline communications installation must support a large number of microinverter endpoints transmitting a small amount of information on an infrequent basis over a dated electrical infrastructure with appliances, power strips, pumps, air conditioners, computers, televisions, and other electrical noise competing with the signal. The robustness of our PLC technology is a compelling attribute of our system and a primary focus of our intellectual property development and engineering resources. In addition, each communication link between a microinverter and the Envoy gateway is encrypted to enhance system security.

Embedded Software

The embedded software that runs in the CPU of our ASIC performs several key functions, including the MPPT algorithm that optimizes energy production from each solar module, the state machine that controls the microinverter's power analysis and power conversion functions, safety functions such as anti-islanding protection, which disables microinverter energy production when the AC grid is disconnected, and the energy information collected from each solar module and microinverter pair. It also actively monitors the operation of the solar PV installation. Finally, it enables the design of more complex functions in software such as sophisticated and intelligent mathematical modeling that reduces the burden on the hardware design.

Web-Based Software

In addition to the embedded software in each Enphase microinverter and Envoy communications gateway, our Enlighten web-based software provides a central point of monitoring and management for the installer and system owner. The system is built on an open source platform and is hosted externally by Rackspace US, Inc., a leading datacenter infrastructure provider. This allows us to minimize our fixed costs and leverage system uptime guarantees from our provider.

The core functionality of our web-based software includes:

- ***Monitoring.*** The Enphase system provides monitoring granularity down to the individual solar module level. This enables the installer and system owner to determine how much energy each solar module is producing and identify poorly performing modules that need to be washed or replaced, including their specific location in the array.
- ***Array Builder and Installer Portal.*** In addition to system level monitoring, analytics and diagnostics, the application is an invaluable tool for the installer for everything from system set-up with tools like the array builder to how they manage their entire fleet of systems with the web-based installer portal. An installer is able to visualize the amount of energy generated in a given day or over the life of the system to ensure its proper operation, identify which modules are not producing to specification and aggregate information from multiple systems for a unified, single view into all solar PV installations under management.
- ***Home Energy Efficiency Device Control.*** Enlighten is a web-based software application for managing solar energy production and controlling energy efficiency devices connected to the Zigbee smart energy profile. Energy efficiency and control represents a potential area of growth for the company as we leverage our communications infrastructure and channel to deliver these additional services.

Our Enlighten web-based software also provides important back-end functionality to Enphase customer service. We use Enlighten to activate a microinverter array, troubleshoot an issue, communicate with the installer, issue and track return merchandise authorizations and analyze energy production trends.

Customers and Sales

Today, our microinverter system is sold in the United States, Canada, France, Italy and the Benelux region. We sell our microinverter systems primarily to distributors who resell to installers and integrators, who in turn integrate our products into complete solar PV installations for residential and commercial system owners.

We work with many of the solar distributors, including Focused Energy LLC, SolarNet Holdings, LLC, SunWize Technologies, Inc., and Solar Solutions and Distribution LLC. Over 3,700 installers have installed our microinverters through March 1, 2012, and this number is increasing by approximately 100 new installers per month.

Installer Customer Growth (Number of Installers)

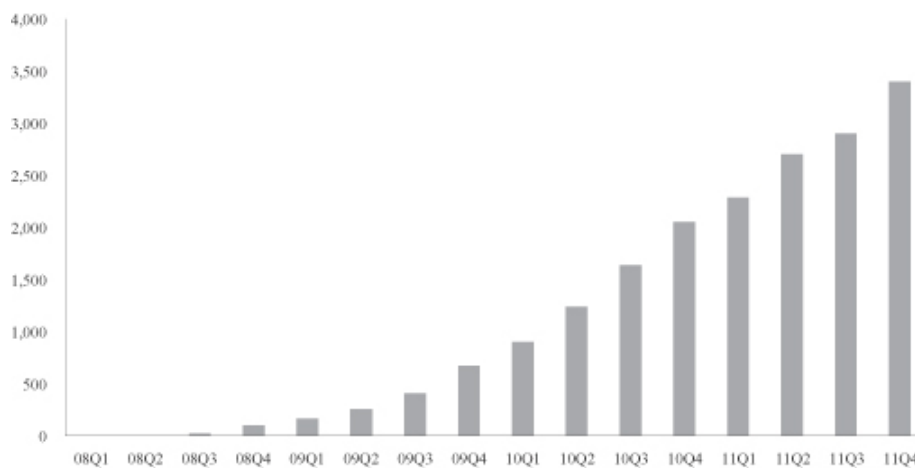

Source: Enphase Energy

In addition to our distributors, we sell directly to large installers, OEMs and strategic partners. Our OEM customers include solar module manufacturers who bundle our products and solutions with their solar module products and resell to both distributors and installers. Strategic partners include a variety of companies and arrangements, including industrial equipment suppliers and providers of solar financing solutions. For example, we have a supply and distribution agreement with Siemens to resell co-branded products and solutions to the electrical contractor distribution channel. We also sell the Enphase-branded product directly to electrical contractor distributors in North America.

To support our geographic expansion plans, we have also established sales and support offices in France and Italy with a go-to-market model similar to the model we use in the United States and Canada. We have established a representative office in China to enhance our support to the Chinese solar module manufacturers with a local on the ground resource, and to establish a sales presence in the country.

Manufacturing and Key Suppliers

We outsource the manufacturing of our products to two key manufacturing partners, Flextronics International Ltd. and Phoenix Contact GmbH & Co. KG. Flextronics assembles and tests our microinverter pursuant to a manufacturing services agreement which is renewable for successive one-year terms and is terminable for convenience by either party upon 90 days prior notice. Prices for such services are mutually agreed to by the parties on a quarterly basis and we are obligated to purchase manufactured products and raw materials that cannot be resold upon the termination of the agreement. Flextronics' assembly and test plants for

[Table of Contents](#)

us are located in Fuyong, China, and New Market, Ontario, Canada. Flextronics also provides receiving, kitting, storage, transportation, inventory visibility and other value-added logistics services at locations managed by Flextronics pursuant to a logistics services agreement which is renewable for successive one-year terms and is terminable for convenience by either party upon 90 days prior notice. Phoenix manufactures the custom AC cable for our third generation M215 microinverter system pursuant to a cooperation agreement with purchase commitments extending through April 2018. Phoenix has agreed that the price it charges us will be no greater than those that Phoenix charges other customers for similar products. The agreement further provides for minimum purchase requirements, and we are obligated to purchase manufactured products and raw materials that cannot be resold upon the termination of the agreement. Phoenix's facility is located in Blomberg, Germany.

We rely on several unaffiliated companies to supply certain components used in the fabrication of our microinverter system. For custom components, key sole source suppliers include Fujitsu Ltd. for our ASIC, Epcos AG for magnetic cores and Phoenix for AC cabling. Magnetic cores are purchased on a purchase order basis from Epcos AG. Our five-year master development and production agreement with Fujitsu extends until August 18, 2014 and is terminable for convenience by either party upon six months prior notice. Additional ASIC design projects are negotiated through mutual task orders governed by the master development agreement. For off-the-shelf components, key single source suppliers include Cree, Inc., for diodes and TDK-EPC Corporation for magnetic components.

Customer Service

We maintain high levels of customer engagement through our customer support group and the Enlighten web-based software portal, and have cultivated an organizational focus on customer satisfaction. Our dedicated customer support group, located at our headquarters in Petaluma, California, focuses on responding to inbound inquiries regarding any of our products and services. This support is provided free of charge to all of our customers in the United States and Canada. To support our international expansion into Europe, we have extended the customer support group to include local coverage based in Lyon, France and Milan, Italy. As of March 1, 2012, our customer support group consisted of 36 employees in the United States and four employees in Europe.

In addition, customized support programs are being developed for selected OEM partners, large direct installers and master distributors to help prioritize and track support issues for key partners and to provide a single point of contact.

Research and Development

We devote substantial resources to research and development with the objective of developing new products and systems, adding new features to existing products and systems and reducing unit costs of our Enphase microinverter system. Our development strategy is to identify features, products and systems for both software and hardware that reduce the cost and optimize the effectiveness of our microinverter solutions for our customers. We measure the effectiveness of our research and development against metrics, including product unit cost, efficiency, reliability, power output and ease-of-use.

We have a strong research and development team with wide-ranging expertise in power electronics, semiconductors, powerline communications and networking, and software engineering. In addition, many members of our team have expertise in solar technologies. As of March 1, 2012, our research and development organization had a headcount of 135 people, 121 of whom are in the United States, one in Canada and 13 in New Zealand. Our research and development expense totaled \$8.4 million, \$14.3 million and \$25.1 million for the years ended December 31, 2009, 2010 and 2011, respectively.

Intellectual Property

Our success depends, in part, on our ability to maintain and protect our proprietary technologies. We rely primarily on patent, trademark, copyright and trade secrets laws in the United States and similar laws in other countries, confidentiality agreements and procedures and other contractual arrangements to protect our technology. As of March 1, 2012, we had 15 issued U.S. patents, two issued non-U.S. patents, 52 patent applications pending for examination in the United States and 111 independent patent applications pending for examination in other countries, all of which are related to U.S. applications. Ten of our issued U.S. patents directly relate to DC to AC power conversion for alternative energy power systems. The remaining five cover anti-islanding safety technology, measurement of grid voltage and monitoring circuits coupled to AC lines, respectively. Our issued patents are scheduled to expire between years 2027 and 2032.

We license certain power line communications technology and software for integration into our ASICs pursuant to a fully-paid, royalty-free license, which includes the right for us to source directly from the licensor's suppliers or manufacture certain ASIC hardware should the licensor fail, under certain conditions, to deliver such technology in the future. This license includes a limited exclusivity period during which the licensor has agreed not to license the licensed technology to any third party manufacturer of electronic components or systems for use in the solar energy market. The license carries a seventy-five year term, subject to earlier termination upon mutual agreement of the parties, or by us in connection with the insolvency of the licensor.

We also license digital intellectual property cores, or IP blocks, for integration into and distribution with certain electronic components built into our products, including our ASICs, complex programmable logic devices, or CPLDs, and field-programmable gate arrays, or FPGAs. This is a fully-paid, non-exclusive, non-transferrable, royalty-free license providing for the integration of such digital IP blocks in an unlimited number of electronic component designs and the distribution of such electronic components with our products. Other than in connection with the distribution of our products, our use of such digital IP blocks is limited to certain of our business sites. The license is perpetual, subject to earlier termination by either party upon the termination, suspension or insolvency of the other party's business, or by the licensor upon a breach of the license agreement by us. In addition, license open source software from third parties for integration into our Envoy products. Such open source software is licensed under open source licenses, including the Beer-Ware License, the GNU General Public License or the GNU Lesser General Public License, Artistic 2.0 License, Ruby License, OpenVPN License, BSD License, Apache License, and other open source licenses. These licenses are perpetual and require us to attribute the source of the software to the original software developer, which we provide via our website.

We continually assess appropriate occasions for seeking patent protection for those aspects of our technology, designs and methodologies and processes that we believe provide significant competitive advantages. A majority of our patents relate to DC to AC power conversion for alternative energy power systems, as well as power system monitoring, control and management systems.

With respect to, among other things, proprietary know-how that is not patentable and processes for which patents are difficult to enforce, we rely on trade secret protection and confidentiality agreements to safeguard our interests. We believe that many elements of our microinverter manufacturing process involve proprietary know-how, technology or data that are not covered by patents or patent applications, including technical processes, test equipment designs, algorithms and procedures.

All of our research and development personnel have entered into confidentiality and proprietary information agreements with us. These agreements address intellectual property protection issues and require our employees to assign to us all of the inventions, designs and technologies they develop during the course of employment with us.

We also require our customers and business partners to enter into confidentiality agreements before we disclose any sensitive aspects of our microinverter, technology or business plans.

We have not been subject to any material intellectual property claims.

Competition

The markets for our products are extremely competitive, and we compete both with well-established traditional central inverter manufacturers and new technology start-ups. The principal areas in which we compete with other companies include:

- Product performance and features;
- Total cost of ownership (usually measured by LCOE);
- Breadth of product line;
- Local sales and distribution capabilities;
- Module compatibility and interoperability;
- Reliability and duration of product warranty;
- Technological expertise;
- Brand recognition and customer service and support;
- Compliance with industry standards and certifications and local electrical code;
- Size and financial stability of operations;
- Size of installed base; and
- Local manufacturing and product content.

Currently, competitors in the inverter market range from large, international companies such as Solar Technology AG, Fronius International GmbH and Power-One, Inc. to emerging companies offering alternative microinverter or other solar electronics products. We principally compete with the large, incumbent solar inverter companies because traditional central inverter solutions can be used as alternatives to our microinverter solution. We believe, however, that our microinverter solutions offer significant advantages and competitive differentiation relative to traditional central inverter technology, even when traditional central inverter technology is supplemented by DC-to-DC optimizers. SMA Solar Technology AG, Power-One Inc. and SunPower Corp., leading inverter vendors serving the residential and small commercial inverter markets, are expected to introduce microinverter products in 2012. In addition, several new entrants to the microinverter market, including some of our OEM customers and partners, have recently announced plans to ship or have already shipped products.

Employees

As of March 1, 2012, we employed 313 full-time employees. Of the full-time employees, 135 were engaged in research and development, 109 in sales and marketing, 49 in a general and administrative capacity and 20 in manufacturing and operations. Of these employees, 272 were in the United States, 13 in France, two in Canada, 10 in Italy, 14 in New Zealand and two in China.

None of our U.S. employees is represented by a labor union with respect to his or her employment with us; however, our employees in France and Italy are represented by a collective bargaining agreement. We have not experienced any employment-related work stoppages, and we consider our relations with our employees to be good.

Legal Proceedings

From time to time, we may be involved in litigation relating to claims arising out of our operations. Currently, we are not involved in any material legal proceedings.

Facilities

Our current corporate headquarters is located in Petaluma, California, in an office consisting of approximately 23,000 square feet of office, testing and product design facilities and a portion of our U.S. customer service center. We have entered into agreements to lease space for a new corporate headquarters also to be located in Petaluma, California, in an office consisting of approximately 96,000 square feet. We occupied 48,000 square feet of our new headquarters in the first quarter of 2012 and, based on current estimates for completion of additional tenant improvements, we anticipate that we will complete our move to the new headquarters in the second quarter of 2012. The leases for the new corporate headquarters will expire ten years from the date tenant improvements are substantially completed, which was in February 2012 for the initial 48,000 square feet. Our current headquarters lease will expire when we have completely vacated the space, which we anticipate will be in the second quarter of 2012.

In addition to our headquarters, we lease approximately 7,500 square feet of warehouse, equipment assembly and general office space in Petaluma, California, on a month-to-month basis, approximately 15,000 square feet of research and development and product verification space in Petaluma, California, under a lease that will expire ten years from the date tenant improvements are substantially completed, which we anticipate will occur in the second quarter of 2012, approximately 10,000 square feet of general office and engineering lab space in Santa Clara, California, pursuant to a lease that will expire on December 31, 2015, 3,500 square feet of general office space in Boise, Idaho, that is used for our tier-1 customer call center operations, pursuant to a lease that will expire in November 2016, and approximately 8,000 square feet of general office and engineering lab space in Christchurch, New Zealand, that will be used for research and development operations, pursuant to a lease that expires in August 2016. We also have a small amount of sales and support office space in Lyon, France, Milan, Italy and Shanghai, China.

We outsource the manufacturing to manufacturing partners, and currently do not own or lease or plan to own or lease manufacturing facilities.

We believe that our existing properties are in good condition and are sufficient and suitable for the conduct of our business for the foreseeable future. To the extent our needs change as our business grows, we believe that additional space and facilities will be available.

MANAGEMENT

Executive Officers and Directors

The following table sets forth the names, ages and positions of our executive officers and directors as of March 1, 2012:

<u>Name</u>	<u>Age</u>	<u>Position(s)</u>
<i>Executive Officers</i>		
Paul B. Nahi	48	President, Chief Executive Officer, and Director
Sanjeev Kumar	48	Chief Financial Officer
Raghuvveer R. Belur	44	Vice President of Products, and Director
Martin Fornage	48	Chief Technology Officer
Jeff Loebbaka	50	Vice President of Worldwide Sales
Greg Steele	50	Vice President of Operations
Bill Rossi	49	Chief Marketing Officer
Dennis Hollenbeck	60	Vice President of Engineering
<i>Directors</i>		
Neal Dempsey ⁽¹⁾⁽²⁾⁽³⁾	70	Director
Steven J. Gomo ⁽²⁾⁽³⁾	59	Director
Benjamin Kortlang ⁽¹⁾⁽²⁾	36	Director
Jameson J. McJunkin ⁽¹⁾	37	Director
Chong Sup Park ⁽²⁾⁽³⁾	64	Director
Robert Schwartz ⁽³⁾	50	Director
Stoddard M. Wilson ⁽³⁾	46	Director

(1) Member of the Nominating and Corporate Governance Committee.

(2) Member of the Audit Committee.

(3) Member of the Compensation Committee.

Our executive officers are appointed by, and serve at the discretion of, our board of directors. There are no familial relationships among our directors and executive officers. Set forth below is biographical information, including the experiences, qualifications, attributes or skills that caused our board of directors to determine that each member of our board of directors should serve as a director as of the date of this prospectus.

Executive Officers

Paul B. Nahi has served as our President and Chief Executive Officer and as a member of our board of directors since January 2007. From 2003 to December 2006, Mr. Nahi served as President and Chief Executive Officer of Crimson Microsystems, Inc., a fabless semiconductor company, where he was responsible for all aspects of the company's operations. From 1999 to 2003, Mr. Nahi served as Chief Executive Officer and co-founder of Accelerant Networks, Inc., a semiconductor company, acquired by Synopsys Inc. in February 2004. From 1998 to 1999, Mr. Nahi served as the General Manager of the Communications and Media Divisions for NEC Electronics Corp., a global electronics company. From 1994 to 1998, Mr. Nahi served as the Senior Director for Diamond Multimedia Systems, Inc., a computer peripheral device company. Mr. Nahi holds a bachelor of science degree in computer science and a master of business administration degree from the University of Southern California. Mr. Nahi brings to our board of directors demonstrated leadership and management ability at senior levels. In addition, his years of experience in the semiconductor and electronics industries provide a valuable perspective for our board. He also brings continuity to our board and historical knowledge of our company through his tenure as President and Chief Executive Officer.

Sanjeev Kumar has served as our Chief Financial Officer since December 2009. From December 2008 to July 2009, Mr. Kumar served as the Chief Financial Officer of HelioVolt Corporation, a producer of thin film solar products, where he was responsible for financial and accounting functions. From June 2006 to August 2008,

[Table of Contents](#)

Mr. Kumar served as the Chief Financial Officer of Energy Conversion Devices, Inc., a supplier of thin-film flexible solar laminates and batteries used in hybrid vehicles, where he was responsible for financial and accounting functions. Prior to 2006, Mr. Kumar served in a number of different finance positions, most recently as the Chief Financial Officer of Rutherford Chemicals LLC, a specialty chemical company, as Chief Financial Officer of the U.S. operations of Rhodia S.A., a publicly held chemicals company, and as Assistant Treasurer, with Occidental Petroleum Corporation, an oil and gas exploration and production company. Mr. Kumar previously served on the Board of Directors of Solar Integrated Technologies Inc., a publicly-listed company in the United Kingdom and Ovonyx, Inc., a privately-held company commercializing its phase-change semiconductor memory technology. Mr. Kumar holds a bachelor of arts degree in business administration from California State University, Los Angeles and a master of business administration degree from the University of Southern California.

Raghuvveer R. Belur co-founded Enphase Energy with Mr. Fornage in March 2006, and has served as a member of our board of directors since March 2006. Mr. Belur has served as our Vice President of Product since September of 2010 and previously as Vice President of Marketing from January 2007 to September of 2010. Mr. Belur was our initial Chief Executive Officer from March 2006 to January 2007. From September 1997 to August 1999, Mr. Belur served as an Engineer for Cerent Corporation, an optical equipment company acquired by Cisco Systems, Inc., in August 1999. Mr. Belur holds a master of science degree in electrical engineering from Texas A&M University and a master of business administration degree from the Haas School of Business at the University of California, Berkeley. As a co-founder of our company and through his position as Vice President of Products, Mr. Belur brings to our board of directors continuity and historic knowledge of our company. In addition, his years of marketing and engineering experience in the electronics industry provide valuable insights for our board.

Martin Fornage co-founded Enphase Energy with Mr. Belur in March 2006, and has served as our Chief Technology Officer since July 2006. From December 1992 to July 1998, Mr. Fornage was a Hardware Engineer at Advanced Fibre Communications, Inc., a telecommunications company acquired by Tellabs, Inc., in May 2004, where he led the Hardware Engineering group in 1997. From September 1998 to February 2006, Mr. Fornage led a consulting firm providing system and assembly level design services to several large telecommunications equipment manufacturers and other companies. Mr. Fornage received his "Ingenieur diplomé d'état" degree from ENSEA France.

Jeff Loebbaka has served as our Vice President of Worldwide Sales since May 2010. From July 2007 to June 2009, Mr. Loebbaka was Senior Vice President of Europe, Middle East and Africa, from July 2005 until June 2007, was Senior Vice President of Global Channel Sales and Marketing, and from October 2003 to June 2005, was Vice President Global Marketing at Seagate Technology LLC, a storage solutions provider. In these positions, he was responsible for sales functions within the geographic or business areas covered by his titles. From September 2000 to September 2003, Mr. Loebbaka served as Vice President and General Manager, and from June 1999 until August 2000, served as Vice President of Worldwide Channels and Corporate Marketing at Adaptec Inc., a RAID controller maker and data center company. From May 1996 to November 1998, Mr. Loebbaka was Vice President of Global Marketing at the Life Fitness Division of Brunswick Corporation, and from January 1995 until May 1996, was the Senior Director of Product Marketing at Zenith Data Systems, a division of Group Bull. Mr. Loebbaka held numerous marketing leadership roles at Apple Inc. from July 1987 until January 1995. Mr. Loebbaka holds a master of business administration degree from the Kellogg Graduate School of Management at Northwestern University and a bachelor of science in mechanical engineering from the University of Illinois.

Greg Steele has served as our Vice President of Operations since January 2008. From March 2006 to December 2007, Mr. Steele founded and served as the President of Wireless Hearing Solutions, an assistive listening device company, where he was responsible for all aspects of the company's operations. From January 2003 to May 2005, Mr. Steele served as the Chief Executive Officer for the Nelson Family of Companies, a human capital and staffing firm. From December 1998 to June 2001, Mr. Steele served as Chief Operating

[Table of Contents](#)

Officer, and from November 1994 to December 1998, served as Vice President of Operations for Advanced Fibre Communications, Inc., a telecommunications company acquired by Tellabs, Inc. in May 2004. From April 1984 to October 1990, Mr. Steele held various manufacturing and operations positions with Texas Instruments Inc., a global electronics company. From October 1990 to November 1994, Mr. Steele held various manufacturing and operations positions with DSC Communications Corporation, a telecommunications company. Greg Steele holds a bachelor of science degree in industrial engineering from Oregon State University.

Bill Rossi has served as our Chief Marketing Officer since September 2010. From December 2007 to July 2010, Mr. Rossi was head of Enterprise Marketing at Google Inc., an Internet search and services company, where he was responsible for marketing of Google applications to businesses. From December 2005 to December 2006, Mr. Rossi was Chief Executive Officer of Greenfield Networks Inc., an ethernet switch technology solutions company acquired by Cisco Systems, Inc., in December 2006, where he was responsible for all aspects of the company's operations. From November 1995 to November 2005, Mr. Rossi served as Vice President and General Manager of the Wireless Networking Business Unit at Cisco Systems, Inc. Mr. Rossi holds a master of business administration degree from Harvard Business School and a bachelor of arts and bachelor of science degree in electrical engineering from Dartmouth College.

Dennis Hollenbeck has served as our Vice President of Engineering since December 2010. From June 2005 to July 2006 Mr. Hollenbeck served as Vice President and General Manager for Maxtor Corp., a hard disc drive manufacturer, where he was responsible for engineering and operations. From June 2000 to September 2005, Mr. Hollenbeck served as Chief Operating Officer for eSilicon Corp., a custom chip design and fabrication service company. From July 1984 to June 2000, Mr. Hollenbeck held various positions with Quantum Corporation, a hard disc drive manufacturer. Mr. Hollenbeck holds a bachelor of engineering, electrical engineering from Youngstown State University.

Board of Directors

Neal Dempsey has served as a member of our board of directors since April 2010. Mr. Dempsey joined Bay Partners as a General Partner in 1989 and became a Managing Member in 2000. From December 1996 to April 2007, Mr. Dempsey served as a member of the board of directors of Brocade Communications Systems, Inc. Mr. Dempsey is presently a director of several privately-held companies and also serves as a director of FamiliesFirst, Inc., a Children and Family Services Agency. Mr. Dempsey holds a bachelor of arts degree from the University of Washington. As a venture capitalist, Mr. Dempsey has been involved with numerous technology companies in the communications, consumer services, energy services, enterprise software, software as a service, and wireless industries. Mr. Dempsey's years of venture capital investing, his previous experience as a public company director and his insights in building successful businesses provide a valuable perspective to the board of directors.

Steven J. Gomo has served as a member of our board of directors since March 2011. From August 2002 until October 2004, Mr. Gomo served as Senior Vice President of Finance and Chief Financial Officer, and from October 2004 until December 2011, as Executive Vice President of Finance and Chief Financial Officer, of NetApp, Inc., a computer storage and data management company. From November 2000 to April 2002, Mr. Gomo served as Chief Financial Officer of Gemplus International S.A., a smart card provider, and from February 1998 until August 2000, Mr. Gomo served as Chief Financial Officer of Silicon Graphics, Inc., a high-performance computer and computer graphics company. Prior to February 1998, Mr. Gomo held various finance, financial management, manufacturing, and general management positions at Hewlett-Packard Company. Mr. Gomo holds a master of business administration degree from Santa Clara University and a bachelor of science degree in business administration from Oregon State University. Mr. Gomo currently serves on the board of SanDisk Corporation and NetSuite Inc. Mr. Gomo brings to our board valuable financial and business expertise through his years of experience as a chief financial officer with publicly traded companies. Mr. Gomo provides an important role in leading the board's activities on financial and auditing matters, as well as collaborating with our independent registered public accounting firm and management team in these areas.

[Table of Contents](#)

Benjamin Kortlang has served as a member of our board of directors since May 2010. Since February 2008, Mr. Kortlang has been a Partner with Kleiner Perkins Caufield & Byers, a venture capital firm. From July 2000 to January 2008, Mr. Kortlang worked with Goldman, Sachs & Co., most recently co-heading Goldman's Alternative Energy Investing business. From June 2005 to February 2008, Mr. Kortlang was a Vice President within Goldman's Special Situations Group, before which he was a Vice President in Goldman's investment banking group focusing on Industrials and Natural Resources. From January 1996 to August 1998, Mr. Kortlang was an Associate with A.T. Kearney, Inc. where he focused on strategic and operations consulting in the energy, manufacturing, packaging, transportation and communications industries. From February 1993 to July 1994, Mr. Kortlang was a Business Analyst at National Australia Bank in strategic planning and macroeconomic forecasting. Mr. Kortlang holds a bachelor of business degree in economics and finance from Royal Melbourne Institute of Technology, a bachelor of commerce and an honors degree in econometrics from University of Melbourne and a master of business administration degree from the University of Michigan. As a venture capitalist, Mr. Kortlang's focus on growth-stage investing in alternative energy technologies provides a valuable industry perspective to our board. Mr. Kortlang's investing and business experience also provide our board with a valuable perspective on building alternative energy businesses.

Jameson J. McJunkin has served as a member of our board of directors since April 2009. Since April 2005, Mr. McJunkin has been a Managing Member of Madrone Capital Partners, a venture capital firm. From August 2000 to March 2005, Mr. McJunkin was a technology growth capital investor at TA Associates, Inc., a private equity firm. Prior to August 2000, Mr. McJunkin worked as a Product Manager at Cisco Systems, Inc. and as a strategy consultant at the Boston Consulting Group. Mr. McJunkin is a director of the Smithsonian National Air and Space Museum and several privately-held companies. He also serves on the Advisory Board for Rockport Capital Partners and The Global Environment Fund. Mr. McJunkin earned a bachelor of arts degree with high honors from the Woodrow Wilson School of Public and International Affairs at Princeton University and a master of business administration degree from the Stanford University Graduate School of Business. Mr. McJunkin has valuable experience as an investor in building emerging growth companies. His investing and business background, as well as his knowledge of the solar industry, provide a valuable perspective for our board of directors.

Dr. Chong Sup Park has served as a member of our board of directors since June 2011. Dr. Park served as President and Chief Executive Officer of Maxtor Corporation, a hard drive manufacturer, from February 1995 to August 1996, and from November 2004 to May 2006, prior to its acquisition by Seagate Technology LLC. Dr. Park served as Maxtor's director from February 1994 and its Chairman of the Board from May 1998 to May 2006. Dr. Park served as Investment Partner and Senior Advisor at H&Q Asia Pacific, a private equity firm, from April 2004 until September 2004, and as Managing Director of the firm from November 2002 to March 2004. Prior to joining H&Q, Dr. Park served as President and Chief Executive Officer of Hynix Semiconductor Inc., a DRAM and FLASH memory manufacturer, from March 2000 until May 2002, and from June 2000 to May 2002 he also served as its Chairman. Dr. Park currently serves as a member of the board of directors of Ballard Power Systems, Inc., Brooks Automation, Inc., Computer Sciences Corporation, and Seagate Technology. Within the past five years, Dr. Park also served as a member of the board of directors of STATS ChipPAC Ltd. and Smart Modular Technologies, Inc. Dr. Park earned his a bachelor of arts degree from Yonsei University, Seoul, a master of business administration degree from the University of Chicago, and a doctorate degree in business administration from Nova Southeastern University. Dr. Park brings to our board of directors valuable experience in leadership, technology, manufacturing, sales and marketing as a former board chair and Chief Executive Officer of global businesses in the storage, semiconductor and electronics industry. Dr. Park with his international background also adds business and cultural diversity to our board of directors' perspective.

Robert Schwartz has served as a member of our board of directors since February 2007. Since June 2000, Mr. Schwartz has been Managing Partner of Third Point Ventures, the Sunnyvale, California-based venture capital arm of Third Point LLC, which is a registered investment adviser based in New York and the investment manager of the Third Point Funds. Since 1984, Mr. Schwartz has also been the President of RF Associates North, Inc., a privately-held technical manufacturer's representative firm. Mr. Schwartz is presently a director of several

[Table of Contents](#)

privately-held companies. Mr. Schwartz holds an undergraduate engineering degree from the University of California, Berkeley. Mr. Schwartz's background as an executive of a technical manufacturer's representative firm provides our board and management with important insights on supply chains and sales channels. In addition, his experience as a venture capital investor and his long-standing experience on our board enables him to provide key insight, historical knowledge and guidance to our management team and board of directors.

Stoddard M. Wilson has served as a member of our board of directors since April 2008. In February 1998, Mr. Wilson joined RockPort Partners as a General Partner, a merchant bank specializing in the energy and environmental sectors, and helped form their venture fund in 2001. From August 1996 to January 1998, Mr. Wilson served as a general manager of Montague Corporation, a manufacturing company. From July 1990 to June 1994, Mr. Wilson served as Director of External Affairs and held positions in Admissions, Development and Financial Assistance with Wilbraham & Monson Academy, a private secondary school. From June 1987 to May 1990, Mr. Wilson held technical, sales and marketing positions with AT&T Inc. Mr. Wilson is presently a director of several privately-held companies. Mr. Wilson holds two bachelor of arts degrees, in history and economics, from Brown University and a master of business administration degree from Harvard Business School. As a venture capitalist, Mr. Wilson's focus on energy and environmental technologies, as well as his experience in building and managing startup businesses, provides a valuable perspective to our board.

Director Independence

Upon the completion of this offering, our common stock is expected to be listed on the NASDAQ Global Market. Under the rules of the NASDAQ Stock Market, LLC, or NASDAQ, "independent" directors must make up a majority of a listed company's board of directors within a specified period following that company's listing date in conjunction with its initial public offering. In addition, applicable NASDAQ rules require that, subject to specified exceptions, each member of a listed company's audit, compensation and nominating committees be independent within the meaning of applicable NASDAQ rules. Audit committee members must also satisfy the independence criteria set forth in Rule 10A-3 under the Securities Exchange Act of 1934, as amended, or the Exchange Act.

In June 2011, our board of directors undertook a review of the independence of each director and considered whether any director has a material relationship with us that could compromise his ability to exercise independent judgment in carrying out his responsibilities. As a result of this review, our board of directors determined that all of our directors, other than Messrs. Nahi and Belur, qualify as "independent" directors within the meaning of the NASDAQ rules. Accordingly, a majority of our directors are independent, as required under applicable NASDAQ rules. As required under applicable NASDAQ rules, we anticipate that our independent directors will meet in regularly scheduled executive sessions at which only independent directors are present.

Board Composition

Our board of directors is currently composed of nine members. Our certificate of incorporation and our bylaws permit our board of directors to establish by resolution the authorized number of directors, and nine directors are currently authorized. Our directors hold office until their successors have been elected and qualified, or the earlier of their death, resignation or removal.

Following the completion of this offering, at each annual meeting of stockholders, a class of directors will be elected for a three-year term to succeed the class whose term is then expiring. The terms of the directors will expire upon the election and qualification of successor directors at the annual meeting of stockholders to be held during 2013 for the Class I directors, 2014 for the Class II directors and 2015 for the Class III directors.

- Our Class I directors will be Raghuvveer R. Belur, Jameson J. McJunkin and Stoddard M. Wilson;
- Our Class II directors will be Neal Dempsey, Benjamin Kortlang and Robert Schwartz; and
- Our Class III directors will be Steven J. Gomo, Chong Sup Park and Paul B. Nahi.

[Table of Contents](#)

The division of our board of directors into three classes with staggered three-year terms may delay or prevent a change of our management or a change in control. Under Delaware law, our directors may be removed for cause by the affirmative vote of the holders of a majority of our voting stock.

Board Committees

Our board of directors has an audit committee, a compensation committee and a nominating and corporate governance committee, each of which has the composition and responsibilities described below.

Audit Committee. Our audit committee oversees our corporate accounting and financial reporting processes. For that purpose, our audit committee, among other things:

- evaluates the qualifications and performance of our independent registered public accounting firm;
- determines and approves the scope of engagement and compensation of our independent registered public accounting firm;
- confers with management and our independent registered public accounting firm regarding the effectiveness of our internal control over financial reporting; and
- establishes procedures for the receipt, retention and treatment of complaints regarding accounting, internal accounting controls or auditing matters.

Our audit committee also has certain responsibilities, including without limitation, the following:

- selecting and hiring the independent registered public accounting firm;
- evaluating the independent registered public accounting firm;
- approving audit and non-audit services and fees; reviewing and discussing with management and the independent registered public accounting firm our annual audited and quarterly financial statements, the results of the independent audit and the quarterly reviews, and the reports and certifications regarding internal control over financial reporting and disclosure controls; and
- reviewing reports and communications from the independent registered public accounting firm.

The members of our audit committee are Messrs. Dempsey, Gomo, Park, and Kortlang. Our board of directors has determined that Mr. Gomo is an “audit committee financial expert” as defined under applicable SEC rules. Mr. Gomo has been appointed to serve as the chairman of our audit committee. Each member of our audit committee meets the requirements for independence for audit committee service under the current requirements of the NASDAQ Global Market and Rule 10A-3 under the Exchange Act.

Compensation Committee. Our compensation committee oversees our corporate compensation policies, plans and benefits programs. The functions of the committee include:

- reviewing and approving the compensation and other terms of employment of our executive officers and senior members of management and reviewing and approving corporate performance goals and objectives relevant to such compensation; and
- administering our stock option plans, stock purchase plans, compensation plans and similar programs, including the adoption, amendment and termination of such plans.

The members of our compensation committee are Messrs. Dempsey, Gomo, Park, Schwartz, and Wilson. Dr. Park has been appointed to serve as the chairman of our compensation committee effective upon the completion of this offering. We believe that each member of our compensation committee meets the requirements for independence under the current requirements of the NASDAQ Global Market, is a non-employee director as defined by Rule 16b-3 promulgated under the Exchange Act, and is an outside director as defined pursuant to Section 162(m) of the Code.

[Table of Contents](#)

Nominating and Corporate Governance Committee. Our nominating and corporate governance committee consists of Messrs. Dempsey, Kortlang and McJunkin, each of whom is a non-employee member of our board of directors. Mr. Dempsey is the chairman of our nominating and corporate governance committee. Our board of directors has determined that each of the directors serving on our nominating and corporate governance committee is independent within the meaning of the listing standards of the NASDAQ Global Market. The functions of this committee include:

- assessing the performance of our management and our board of directors;
- identifying, reviewing, and evaluating candidates to serve on our board of directors, including nominations by stockholders of candidates for election to our board of directors;
- reviewing and evaluating incumbent directors;
- making recommendations to our board of directors regarding the membership of the committees of the board of directors; and
- developing a set of corporate governance principles.

Compensation Committee Interlocks and Insider Participation

Our compensation committee currently consists of Messrs. Dempsey, Gomo, Park, Schwartz, and Wilson. None of the members of our compensation committee has, at any time, been one of our officers or employees. None of our executive officers serves, or in the past year has served, as a member of the board of directors or compensation committee of any entity that has one or more executive officers serving on our board of directors or compensation committee. For more information, see “Certain Relationships and Related Party Transactions” appearing elsewhere in this prospectus.

Code of Business Conduct and Ethics

Our board of directors adopted a code of business conduct and ethics that applies to all of our employees, officers and directors, including those officers responsible for financial reporting. Upon the completion of this offering, the code of business conduct and ethics will be available on our website at www.enphase.com. We intend to disclose future amendments to the code, or any waivers of its requirements on our website to the extent permitted by the applicable rules and exchange requirements. The inclusion of our website address in this prospectus does not include or incorporate by reference the information on our website into this prospectus.

Non-Employee Director Compensation

Except as described below, during 2011 our non-employee directors did not receive any cash compensation, stock awards or other compensation for their services as members of our board of directors or any committee of our board of directors. Except as described below, as of December 31, 2011 none of our non-employee directors held any outstanding stock options or stock awards.

In connection with the appointment of Mr. Gomo to our board in March 2011, he received a stock option to purchase 33,039 shares of common stock with an exercise price of \$4.09 per share. This option grant vests as to 688 shares per month, beginning from March 10, 2011. In connection with the appointment of Dr. Park to our board in June 2011, he received a stock option to purchase 33,039 shares of common stock with an exercise price of \$9.53 per share. This option grant vests as to 688 shares per month, beginning from June 23, 2011.

[Table of Contents](#)

Director compensation table

The following table sets forth information regarding fees paid to our non-employee directors for their service on our board of directors during the year ended December 31, 2011.

<u>Name</u>	<u>Fees earned or paid in cash</u>	<u>Option awards⁽¹⁾</u>	<u>Total</u>
Neal Dempsey	\$ —	\$ —	\$ —
Steven J. Gomo	—	170,919	170,919
Benjamin Kortlang	—	—	—
Jameson J. McJunkin	—	—	—
Chong Sup Park	—	199,443	199,443
Robert Schwartz	—	—	—
Stoddard M. Wilson	—	—	—

(1) Amounts reflect the grant date fair value of stock options granted in 2011 calculated in accordance with applicable accounting guidance for share-based payment transactions. The valuation assumptions used in determining such amounts are described in Note 10 to Consolidated Financial Statements appearing elsewhere in this prospectus.

New Director Compensation Program

Effective upon completion of this offering our non-employee directors will receive the following cash compensation:

Annual retainer board member	\$35,000
Additional retainer audit committee chair ⁽¹⁾	18,000
Additional retainer audit committee member ⁽²⁾	8,000
Additional retainer compensation committee chair ⁽¹⁾	12,000
Additional retainer compensation committee member ⁽²⁾	6,000
Additional retainer nominating and governance committee chair ⁽¹⁾	8,000
Additional retainer nominating and governance committee member ⁽²⁾	3,000

(1) Assumes five committee meetings per year, after which a \$1,500 per meeting fee will apply.

(2) Assumes five committee meetings per year, after which a \$1,000 per meeting fee will apply.

In addition, each board member will receive an initial option grant with a target value of \$120,000, with 25% of the shares vested on the grant date and 25% vesting on each annual anniversary thereafter, and an annual option grant with a target value of \$75,000 vesting after one year, in each case using a Black-Scholes option value model and with an exercise price per share equal to the fair market value on the date of grant.

We also intend to seek to recruit and/or appoint either a non-employee chairman of our board of directors or a lead independent director. We expect that an annual cash retainer will be established for this position, and the chairman or lead independent director will be eligible to receive stock option grants in light of his or her role and responsibilities. We expect that the overall compensation for this position will reflect the value brought by the specific individual appointed to this position, based on the responsibility and time commitments associated with this role, as well as market conditions at the relevant time.

COMPENSATION DISCUSSION AND ANALYSIS

The following discussion provides an overview of our executive compensation philosophy, the overall objectives of our executive compensation program, and each compensation component that we provide. In addition, we explain how and why we arrived at specific compensation policies and decisions involving our executive officers, including Messrs. Nahi, Kumar, Hollenbeck, Loebbaka and Steele, who are referred to as our named executive officers and are listed in the “Summary Compensation Table” set forth under “Executive Compensation,” during 2011.

This Compensation Discussion and Analysis contains forward-looking statements that are based on our current plans, considerations, expectations, and determinations regarding future compensation programs. The actual compensation programs that we adopt may differ materially from currently planned programs that are summarized in this discussion.

Executive Compensation Philosophy and Objectives

We compete with many other companies in seeking to attract and retain a skilled management team. To meet this challenge, we have employed a compensation philosophy of offering our executive officers competitive compensation and benefits packages that focus on long-term value creation and rewarding the management team members for achieving our financial and strategic objectives.

We have oriented our executive compensation program to accomplish the following objectives:

- provide total compensation opportunities, which enable us to recruit and retain executives with the experience and skills to manage our growth and lead us to the next stage of development;
- create a direct and meaningful link between our business results, individual performance, and rewards;
- establish a clear alignment between the interests of our executives and the interests of our stockholders;
- reinforce a culture of ownership, excellence, and urgency; and
- offer total compensation that we believe is competitive and fair.

Compensation Program Design

To date, the compensation of our executive officers, including our named executive officers, has consisted of base salaries, cash bonuses, equity compensation in the form of stock options and restricted stock awards, employee benefits, relocation packages and certain post-employment arrangements.

The key component of our executive compensation program has been equity awards for shares of our common stock. As a privately-held company prior to this offering, we have emphasized the use of equity to provide incentives for our executive officers to focus on the growth of our overall enterprise value and, correspondingly, to create value for our stockholders. We have used stock options as our primary equity award vehicle. We believe that stock options offer our employees, including our named executive officers, a valuable long-term incentive that aligns their interests with the long-term interests of our stockholders.

We also offer cash compensation in the form of base salaries and cash bonuses that we believe, overall, are competitive within the market range for companies of similar size, stage of development, and growth potential.

We have not adopted policies or guidelines for allocating compensation between current and long-term compensation, between cash and non-cash compensation, or among different forms of non-cash compensation. Instead, we review each component of executive compensation separately and also take into consideration the

[Table of Contents](#)

value of each executive's compensation package as a whole, both based on its value and its relative size in comparison to the other members of the executive team.

Compensation-Setting Process

To obtain the skills and experience that we believe are necessary to lead our growth, most of our executive officers were hired from larger organizations and have significant experience in their roles. Their initial compensation arrangements were determined in individual negotiations with each executive in connection with his joining us, taking into account his qualifications, experience, and prior compensation levels.

Since July 2010, our compensation committee has been responsible for overseeing our executive compensation program, as well as determining and approving the ongoing compensation arrangements for our Chief Executive Officer and our other executive officers, including our named executive officers. Typically, our Chief Executive Officer makes recommendations to our compensation committee regarding compensation matters, except with respect to his own compensation, and will often attend the compensation committee meetings, while excusing himself from any discussions involving his own compensation. The recommended compensation of our Chief Executive Officer is proposed by our compensation committee. Once finalized, typically recommendations for executive compensation are presented by our compensation committee to our board of directors for its approval, though our compensation committee has the authority to approve the compensation of the executive officers within guidelines pre-determined by our board of directors. In July 2010, our board of directors approved a compensation committee charter that delegates to our compensation committee the authority to establish and review the compensation of our executive officers, including our named executive officers.

Our compensation committee is authorized to retain the services of executive compensation advisors from time to time, as it sees fit, in connection with the establishment of cash and equity compensation plans and arrangements and related policies. In August 2010, our compensation committee engaged Compensia, Inc., a national compensation consulting firm providing executive compensation advisory services, to assist it in evaluating our executive compensation philosophy, to provide market data on executive compensation practices and to provide guidance on administering our executive, employee and equity compensation programs. Compensia serves at the discretion of our compensation committee.

Use of Competitive Data

Beginning in 2011, to assess the competitiveness of our executive compensation program and current compensation levels and to assist it in setting compensation levels, our compensation committee refers to compensation data compiled with respect to the compensation of executives in comparable positions at a group of comparable companies, which we refer to as the peer group. The companies comprising the peer group have been selected on the basis of their similarity to us in size (as determined by revenue and market capitalization) and product or service similarity. Compensation data for the companies comprising the peer group is gathered from public filings and from Compensia's proprietary compensation databases.

For 2011, based on consultations with Compensia, our compensation committee approved the following companies as our peer group for purposes of determining compensation:

A123 Systems, Inc.	Digi International Inc.	Maxwell Technologies, Inc.
Acme Packet, Inc.	Echelon Corporation	Nanometrics Incorporated
Advanced Energy Industries, Inc.	EMCORE Corporation	Powersecure International, Inc.
Aruba Networks, Inc.	Energy Conversion Devices, Inc.	SatCon Technology Corporation
CalAmp Corp.	EnerNOC, Inc.	Sonus Networks, Inc.
Codexis, Inc.	Fortinet, Inc.	Vicor Corporation
Comverge, Inc.	Isilon Systems, a division of EMC Corporation	

[Table of Contents](#)

Our compensation committee intends to review the composition of the peer group periodically and make adjustments to its composition as necessary.

In addition to the peer group, beginning in 2011, our compensation committee reviewed survey data from the Radford Global Technology Survey to supplement its understanding of the market for executive compensation.

While our compensation committee reviews the compensation data for, and compensation practices from, the peer group to inform its decision-making process, it does not set compensation components to meet specific benchmarks. Our compensation committee uses peer-group data as a point of reference so that it can set total compensation levels that it believes are reasonably competitive, but also believes that over-reliance on benchmarking can result in compensation that is unrelated to the value delivered by our executives. While compensation levels may differ among executives on competitive factors, and the role, responsibilities and performance of each specific executive, there are no material differences in the compensation philosophies, objectives or policies for our executives, including our named executive officers.

Executive Compensation Program Components

The following describes each component of our executive compensation program, the rationale for each, and how awards are determined.

Base Salary

In February 2011, we adjusted the base salaries of our named executive officers (retroactive to January 2011) as follows:

- We increased the base salary of Mr. Nahi by \$60,000 to \$310,000 to reflect his successful execution of our business strategy during 2010, particularly in increasing the market penetration of our products and growing our sales. This increase was also based on his success in positioning our company, consistent with this strategy, for a potential initial public offering of our equity securities, and the competitive market for chief executive officers of technology and alternative energy companies, as reflected in the market survey data and our peer group as reported to our compensation committee by Compensia. This adjustment raised Mr. Nahi's base salary to a level of approximately the 50th percentile of the appropriate market data as reported by Compensia.
- We set the base salary of Mr. Hollenbeck at the time he joined our company in December 2010. While our compensation committee reviewed market data for top engineering positions at other technology companies provided by Compensia to understand the competitive landscape, Mr. Hollenbeck's base salary was determined based on our negotiations with him. At the time he joined us, his base salary approximated the 75th percentile of the market data reported by Compensia. We did not make any adjustment to his base salary in 2011.
- We increased the base salary of Mr. Loebbaka, our Vice President of Worldwide Sales, by \$10,000 to reflect the competitive market for sales executives of technology and alternative energy companies, as reflected in the market data as reported by Compensia. This adjustment raised his base salary to a level of approximately the 50th percentile of the appropriate market data reported by Compensia.
- We increased the base salary of Mr. Steele, our Vice President of Operations, by \$25,000 to reflect his performance in executing our business strategy, the market data and our desire to ensure that there was minimal differentiation in the base salaries of our senior executive officers. This adjustment raised his base salary to a level approximately between the 50th and 75th percentiles of the appropriate market data reported by Compensia.
- Mr. Kumar did not receive a base salary adjustment in 2011 because it was determined that his current base salary was competitive against the market.

Cash Bonuses

We use cash bonuses to motivate our executive officers to achieve our annual financial and strategic objectives. In some cases, the initial cash bonus opportunities of our executive officers were established through arm's-length negotiation at the time of hiring. Aside from pre-agreed upon bonus opportunities, bonus opportunities historically have been provided on a discretionary basis by our compensation committee.

For 2011, for all of our executive officers other than Messrs. Nahi and Loebbaka, we developed a formalized bonus program for all employees based on input from Compensia on public company market practices for bonus plan design. For our named executive officers, we set maximum bonus amounts and performance goals. For these executives, our 2011 bonus plan is based 60% on achievement of corporate goals and 40% on achievement of individual performance goals.

For the named executive officers participating in the executive bonus program, target bonuses, as a percentage of base salary, are as follows: 40% for Mr. Kumar and 25% for Messrs. Hollenbeck and Steele. These target percentages were determined by our compensation committee based on its judgment taking into consideration the projected scaling of our business in 2011, Mr. Nahi's recommendations, our compensation committee's evaluation of the individual contributions and responsibilities of each executive officer and the executive compensation market data provided by Compensia that showed that overall our 2010 bonuses were lower than bonus levels for comparable public companies.

For the 2011 executive bonus program, the Compensation Committee established corporate goals with respect to revenue and gross margin, with the target for both goals required to be achieved for any payout for this portion of the bonus plan. The revenue and gross margin targets were \$108.0 million and 18.5%, respectively. If both goals are achieved at between 100% and 150% of the target, then the payout percentage for the corporate goal portion of the bonus is the lowest of the two percentages achieved. If both goals are achieved at greater than 150% of the target, then the payout for the corporate goal portion of the bonus is increased to 200% of the target amount.

For the 2011 executive bonus program, each participating executive received a set of individual goals. The executive can earn up to but no more than 40% of his target bonus for achievement of these individual goals. Mr. Nahi worked with each executive to set individual goals based on the personal performance of the executive and the performance of his department. These were formalized in February 2011. Our executive's individual goals consisted of the following:

- Mr. Kumar's goals consisted of implementing new accounting systems for public company reporting requirements, including the appropriate level of internal controls, responsibility for our financing strategy prior to an initial public offering, or IPO, responsibility for the IPO filing and related requirements, and preparing the finance department for public company reporting requirements.
- Mr. Hollenbeck's goals consisted of responsibility for key new product launches, strengthening the development capabilities of the engineering department and developing future products.
- Mr. Steele's goals consisted of ensuring sufficient production of key products and then reducing per unit costs while increasing product quality.

As in prior years, Mr. Nahi's bonus was determined by the Compensation Committee on a discretionary basis. For 2011, Mr. Nahi earned a bonus of \$155,000 equal to 50% of his base salary. In determining Mr. Nahi's discretionary bonus, the Committee considered our 2011 financial performance, product and engineering milestones, penetration of new geographic markets, strategic leadership and progress towards an initial public offering.

Mr. Loebbaka participates in a quarterly sales objective bonus plan instead of the executive annual bonus program. For 2011, his annualized target bonus is 62% of his base salary, or \$145,000. Mr. Loebbaka's quarterly bonus was based on achievement of quarterly revenue-based sales performance targets, weighted at 75% of his

[Table of Contents](#)

aggregate sales objective bonus, and specified non-revenue-based objectives weighted at 25% of his aggregate sales objective bonus. Mr. Loebbaka's revenue-based sales target for 2011 was \$130.6 million and his non-revenue-based key sales objectives were set by the Chief Executive Officer periodically and consisted of management and development of key customer accounts, both developing new client relationships and maintaining and increasing existing client relationships, overseeing expansion of sales into new regions and similar client and business development goals. The sales objective bonus plan provided for pre-determined multipliers, ranging from 2.0x to 4.0x, for performance above 100% of target. Mr. Loebbaka achieved between 116% and 126% of his revenue-based performance target for each quarter of fiscal 2011, resulting in a revenue-based bonus of \$158,775 after application of the pre-determined multipliers, and \$51,656 with respect to his performance against his non-revenue based sales objectives as determined by the Chief Executive Officer, for a total sales objective bonus of \$210,431.

At this time, our compensation committee has not finalized the payouts under the 2011 bonus plan for our other named executive officers. It is expected that such payouts will be finalized and approved in the first half of 2012.

The cash bonuses paid to our named executive officers for 2011 will be set forth in the "Summary Compensation Table" under "Executive Compensation" once finalized and approved by the Board of Directors.

We do not have a formal policy regarding adjustment or recovery of bonus awards or payments if the relevant performance measures upon which they are based are restated or otherwise adjusted in a manner that would have originally reduced the size of the awards or payments.

Equity Compensation

We use equity awards to incentivize and reward our executive officers, including our named executive officers, for long-term corporate performance based on the value of our common stock and, thereby, to align the interests of our executive officers with those of our stockholders.

To date, we have not applied a rigid formula in determining the size of the initial equity awards that have been granted to our named executive officers. Instead, these awards were established through arms-length negotiation at the time of hiring. In these negotiations, our board of directors has exercised its judgment, taking into consideration, among other things, the prospective role and responsibility of the executive, competitive factors, the amount of equity-based equity compensation held by the executive officer at his former employer, and the cash compensation received by the executive officer. Based upon these factors, our board of directors has determined the size of each award at levels it considered appropriate to create a meaningful opportunity for reward predicated on the creation of long-term stockholder value.

Thereafter, our board of directors has granted equity awards to our executive officers, including our named executive officers, on an ad hoc basis when it deemed additional grants were appropriate. In making these awards, our board has exercised its judgment as to the amount and form of the awards, taking into consideration our performance, the board's evaluation of the expected and actual performance of each executive officer, his individual contributions and responsibilities, the dilution of the executive as a result of our financings and market conditions.

In making the allocations of both initial equity awards and additional awards, our board of directors has considered objectives such as motivating executives to achieve company objectives, providing incentives to promote our growth and create stockholder value, and aligning the financial interests of our executive officers with those of our stockholders. The board of directors has also considered the potential dilutive effect on our stockholders.

[Table of Contents](#)

In 2011, we granted stock options to Messrs. Hollenbeck and Steele, our Vice President of Engineering and our Vice President of Operations, respectively. Mr. Hollenbeck received his grant in connection with his initial employment with us. Mr. Steele received an additional “refresh” grant.

- In the case of Mr. Hollenbeck, we granted him a stock option to purchase 211,625 shares of our common stock with an aggregate grant date fair value of approximately \$632,117 in January 2011. The size of this award was determined based on our negotiations with Mr. Hollenbeck, our objective of inducing Mr. Hollenbeck to accept employment and our Board of Directors’ collective experience with market practices for equity compensation for top engineering executives.
- In the case of Mr. Steele, we granted him a “refresh” stock option to purchase 44,052 shares of our common stock with an aggregate grant date fair value of approximately \$265,925 in September 2011. The purpose of the grant was to provide Mr. Steele with an additional long-term incentive opportunity and to promote our retention objectives. The size of this award was determined by evaluating his outstanding and unvested equity holdings, his performance and our Board of Directors’ collective experience with market practices for equity compensation for top operations executives. Our board of directors believed that this award was an appropriate means of rewarding his near-term performance, while, at the same time, reinforcing his ties to our company and incentivizing him to continue to successfully execute our strategy.

The equity awards granted to our named executive officers during 2011 are set forth in the “Summary Compensation Table” and “Grants of Plan-Based Awards” table under “Executive Compensation.”

To date, we have not granted any additional equity compensation to our named executive officers in 2012.

Following the completion of this offering, we expect our compensation committee to oversee the development of an annual equity compensation “refresh” program.

Retirement and Other Benefits

We have established a tax-qualified Section 401(k) retirement savings plan for our executives, including our named executive officers, and other employees who satisfy certain eligibility requirements. Under this plan, participants may elect to make pre-tax contributions of up to 100% of their current compensation, not to exceed the applicable statutory income tax limitation (which was \$16,500 in 2011 for employees under 50 years of age and \$22,000 for employees who are 50 years of age or older). In 2011, we contributed three percent of each employee’s base salary into his or her 401(k) account.

Additional benefits received by our executives, including our named executive officers, include medical, dental, and vision benefits, medical and dependent care flexible spending accounts, short-term and long-term disability insurance, accidental death and dismemberment insurance and basic life insurance coverage. We provide these benefits to our executives on the same basis as to all of our full-time employees. We provided relocation packages for our Chief Financial Officer and our Vice President of Worldwide Sales in connection with their initial employment prior to 2011. The amount of each relocation package was determined based on our arm’s-length negotiations with each executive officer, our compensation committee’s knowledge of the costs and size of executive relocation packages, as well as input from our external recruiter.

Historically, other than the relocation packages discussed above, we have not provided perquisites or other personal benefits to our executives, including our named executive officers. However, in the future we may provide such items in limited circumstances, such as when we believe it is appropriate to assist an individual in the performance of his or her duties, to make our executives more efficient and effective, and to recruit, motivate, or retain executives. All future practices with respect to perquisites or other personal benefits for executives will be approved and subject to periodic review by our compensation committee.

Post-Employment Compensation

In connection with the hiring of each of our named executive officers, we entered into an employment agreement or offer letter that typically provided for his base salary, bonus opportunity, initial stock option grant, employee benefits and, in some cases, potential benefits upon a termination of employment, including a termination of employment following a change in control of us. In June 2011, our compensation committee and board of directors undertook a review of these termination benefits across our executive team. As a result of this review, the committee and our board determined that these arrangements should be updated to provide more consistency for these benefits among our executives as well as provide benefits that we and Compensia believe are generally comparable to our peer group of companies. Accordingly, our board of directors approved our entering into new executive severance agreements with Mr. Nahi, and new change in control and severance agreements with Messrs. Kumar, Loebbaka, Hollenbeck and Steele. For a summary of the material terms and conditions of the employment agreements for our named executive officers, see “Executive Compensation—Employment Agreements.”

We believe that the severance and change in control benefits set forth in each named executive officer’s employment agreement assisted us in attracting our executive officers. We also believe that these benefits help our executive officers maintain continued focus and dedication to their assigned duties to maximize stockholder value if there is a potential transaction that could involve a change in control of our company. For a summary of the material terms and conditions of these provisions, see “Executive Compensation—Potential Payments Upon Termination or Change in Control.”

Tax and Accounting Considerations

Deductibility of Executive Compensation

As a private company, in making our compensation decisions, we have not considered Section 162(m) of the Internal Revenue Code, or the Code, which disallows a tax deduction to any publicly-held corporation for any remuneration in excess of \$1 million paid in any taxable year to its chief executive officer and each of its other named executive officers (other than its chief financial officer) unless an exception applies. We expect our compensation arrangements put in place prior to our initial public offering and for several years thereafter will be exempt under Section 162(m) of the Code.

Once our exemption period expires, we expect that our compensation committee may, where reasonably practicable, consider compensation that would qualify for the “performance-based compensation” exemption from the deductibility limit. Our compensation committee may, in its judgment, authorize compensation payments that do not comply with an exemption from the deductibility limit when it believes that such payments are appropriate to attract and retain executive talent.

Taxation of “Parachute” Payments

Sections 280G and 4999 of the Code provide that executive officers and directors who hold significant equity interests and certain other service providers may be subject to an excise tax if they receive payments or benefits in connection with a change in control of our company that exceeds certain prescribed limits, and that our company (or a successor) may forfeit a deduction on the amounts subject to this additional tax. We do not currently provide any executive, including any named executive officer, with a “gross-up” or other reimbursement payment for any tax liability that he may owe as a result of the application of Sections 280G or 4999.

EXECUTIVE COMPENSATION

Summary Compensation Table

The following table provides information for the years presented regarding the compensation of our principal executive officer, principal financial officer, and each of our three other most highly compensated persons serving as executive officers as of December 31, 2011. We refer to these persons as our named executive officers.

<u>Name and Principal Position</u>	<u>Year</u>	<u>Salary (\$)</u>	<u>Bonus⁽¹⁾ (\$)</u>	<u>Option Awards⁽²⁾ (\$)</u>	<u>Non-Equity Incentive Plan Compensation (\$)</u>	<u>All Other Compensation (\$)</u>	<u>Total (\$)</u>
Paul B. Nahi President and Chief Executive Officer	2011	310,000	155,000	—	—	9,868 ⁽³⁾	474,868
	2010	250,000	30,000	952,319	10,000 ⁽⁴⁾	7,431 ⁽³⁾	1,249,750
Sanjeev Kumar Chief Financial Officer	2011	225,000	—	—	⁽⁵⁾	8,405 ⁽⁶⁾	233,405 ⁽⁵⁾
	2010	225,000	—	224,924	50,000 ⁽⁷⁾	71,305 ⁽⁶⁾	571,229
Dennis Hollenbeck Vice President of Engineering	2011	250,000	—	632,117	⁽⁸⁾	8,256 ⁽⁹⁾	890,373 ⁽⁸⁾
Jeff Loebbaka Vice President of Worldwide Sales	2011	235,000	—	—	210,431 ⁽¹⁰⁾	8,344 ⁽¹¹⁾	453,775
	2010	147,115 ⁽¹²⁾	—	396,889	133,325 ⁽¹³⁾	26,593 ⁽¹¹⁾	703,922
Greg Steele Vice President of Operations	2011	225,000	—	265,925	⁽¹⁴⁾	7,285 ⁽¹⁵⁾	498,210 ⁽¹⁴⁾

- (1) Amounts reported in column reflect discretionary cash bonuses determined by the board of directors.
- (2) Amounts reported in column reflect the aggregate grant date fair value of stock options granted pursuant to our 2006 Equity Incentive Plan during the relevant fiscal years, calculated in accordance with applicable accounting guidance for share-based payment transactions and excludes the impact of estimated forfeitures related to service-based vesting conditions. The valuation assumptions used in determining such amounts are described in Note 10 to Consolidated Financial Statements appearing elsewhere in this prospectus.
- (3) For 2011, amount consists of contributions by us of \$7,350 to Mr. Nahi's 401(k) account, \$1,960 for financial planning services and \$558 in basic life insurance premiums paid by us. For 2010, amount consists of \$7,350 of company contributions to Mr. Nahi's 401(k) account and \$81 in basic life insurance premiums paid by us.
- (4) Amount reflects a cash bonus determined by the board of directors pursuant to Mr. Nahi's achievement against certain pre-determined performance criteria. For more information regarding Mr. Nahi's performance plan-based cash bonus, see "Compensation Discussion and Analysis—Executive Compensation Program Components."
- (5) Mr. Kumar is eligible to receive a cash bonus under our 2011 bonus program of up to \$144,000 based upon achievement against predetermined performance criteria; however, the bonus has not been finalized and approved by the board as of the date of this prospectus. Accordingly, Mr. Kumar's 2011 total compensation as reported does not include the 2011 cash bonus.
- (6) For 2011, amount consists of contributions by us of \$6,880 to Mr. Kumar's 401(k) account, \$1,120 for financing planning services and \$405 in basic life insurance premiums paid by us. For 2010, amount consists of \$294 in interest forgiven by us and a tax gross-up of \$3,019 paid by us in connection with the advance payment of Mr. Kumar's cash bonus in the form of a loan and subsequent loan forgiveness; relocation benefits consisting of temporary housing, destination and relocation bonus amounts totaling \$61,161; contributions by us of \$6,750 to Mr. Kumar's 401(k) account; and \$81 paid by us on Mr. Kumar's behalf for basic life insurance premiums. For more information regarding Mr. Kumar's cash bonus and related loan forgiveness, see "Certain Relationships and Related Party Transactions—Loan to Officer."
- (7) Mr. Kumar's cash bonus was paid in advance in the form of a loan in a principal amount of \$50,000, which loan was subsequently forgiven following Mr. Kumar's achievement of certain bonus related performance targets. For more information regarding Mr. Kumar's cash bonus and related loan forgiveness, see "Certain Relationships and Related Party Transactions—Loan to Officer."
- (8) Mr. Hollenbeck is eligible to receive a cash bonus under our 2011 bonus program of up to \$100,000 based upon achievement against predetermined performance criteria; however, the bonus has not been finalized and approved by the board as of the date of this prospectus. Accordingly, Mr. Hollenbeck's 2011 total compensation as reported does not include the 2011 cash bonus.
- (9) Amount consists of contributions by us of \$7,350 to Mr. Hollenbeck's 401(k) account and \$450 paid by us in basic life insurance premiums.
- (10) Amount represents \$210,431 paid to Mr. Loebbaka under our 2011 sales objective bonus plan. For more information regarding Mr. Loebbaka's sales objective bonus plan, see "Compensation Discussion and Analysis—Executive Compensation Program Components."

Table of Contents

- (11) For 2011, amount consists of contributions by us of \$7,186 to Mr. Loebbaka's 401(k) account, \$735 for financing planning services and \$423 in basic life insurance premiums paid by us. For 2010, amount consists of relocation benefits for temporary housing and relocation bonus amounts totaling \$22,133, contributions by us of \$4,413 to Mr. Loebbaka's 401(k) account and \$47 paid by us in basic life insurance premiums.
- (12) Amount represents a partial year of base salary of \$225,000 since his hire date of May 3, 2010.
- (13) Amount represents \$133,325 paid to Mr. Loebbaka under our 2010 sales commission plan.
- (14) Mr. Steele is eligible to receive a cash bonus under our 2011 bonus program of up to \$90,000 based upon achievement against predetermined performance criteria; however, the bonus has not been finalized and approved by the board as of the date of this prospectus. Accordingly, Mr. Steele's 2011 total compensation as reported does not include the 2011 cash bonus.
- (15) Amount consists of contributions by us of \$6,880 to Mr. Steele's 401(k) account and \$405 paid by us in basic life insurance premiums.

Grants of Plan-Based Awards

The following table provides information regarding grants of plan-based awards to each of our named executive officers during 2011.

Name	Grant Date	Estimated Possible Payouts Under Non-Equity Incentive Plan Awards			All Other Option Awards: Number of Securities Underlying Options (#)	Exercise or Base Price of Option Awards (per Share) ⁽¹⁾ (\$/Share)	Grant Date Fair Value of Stock and Option Awards ⁽²⁾ (\$)
		Threshold (\$)	Target (\$)	Maximum (\$)			
Paul B. Nahi	—	—	—	—	—	—	—
Sanjeev Kumar	—	—	90,000 ⁽³⁾	144,000 ⁽³⁾	—	—	—
Dennis Hollenbeck	1/21/2011	—	62,500 ⁽⁴⁾	100,000 ⁽⁴⁾	211,625 ⁽⁵⁾	2.54	632,117
Jeff Loebbaka	—	—	145,000 ⁽⁶⁾	—	—	—	—
Greg Steele	9/15/2011	—	56,250 ⁽⁷⁾	90,000 ⁽⁷⁾	44,052 ⁽⁵⁾	9.53	265,925

- (1) Our common stock was not publicly traded during 2011, and the exercise price of the options was determined by our board of directors based on its determination of the fair market value of our common stock on the grant date. For more information on our methodology for determining the exercise price of the options, see “Management’s Discussion and Analysis of Financial Condition and Results of Operations—Critical Accounting Policies and Significant Management Estimates—Stock-Based Compensation” appearing elsewhere in this prospectus.
- (2) In accordance with SEC rules, this column represents the aggregate grant date fair value of each equity award, calculated in accordance with applicable accounting guidance for stock-based payment transactions. For additional information on the valuation assumptions underlying the value of these awards, see Note 11 to Consolidated Financial Statements appearing elsewhere in this prospectus. For more information on our methodology for determining the exercise price of the options, see “Management’s Discussion and Analysis of Financial Condition and Results of Operations—Critical Accounting Policies and Significant Management Estimates—Stock-Based Compensation” appearing elsewhere in this prospectus.
- (3) Reflects the target and maximum amounts payable to Mr. Kumar pursuant to his performance plan-based cash bonus for the year ended December 31, 2011. No minimum threshold amount was established. For more information regarding Mr. Kumar’s performance plan-based cash bonus, see “Compensation Discussion and Analysis—Executive Compensation Program Components.”
- (4) Reflects the target and maximum amounts payable to Mr. Hollenbeck pursuant to his performance plan-based cash bonus for the year ended December 31, 2011. No minimum threshold amount was established. For more information regarding Mr. Hollenbeck’s performance plan-based cash bonus, see “Compensation Discussion and Analysis—Executive Compensation Program Components.”
- (5) The vesting schedules for these options are described in the footnotes to the Outstanding Equity Awards at December 31, 2011 table below.
- (6) Reflects the target amount payable to Mr. Loebbaka pursuant to our sales objective bonus plan for the year ended December 31, 2011. No minimum threshold or maximum amounts beyond the target amount were established. For more information regarding Mr. Loebbaka’s sales objective bonus, see “Compensation Discussion and Analysis—Executive Compensation Program Components.”
- (7) Reflects the target and maximum amounts payable to Mr. Steele pursuant to his performance plan-based cash bonus for the year ended December 31, 2011. No minimum threshold amount was established. For more information regarding Mr. Steele’s performance plan-based cash bonus, see “Compensation Discussion and Analysis—Executive Compensation Program Components.”

The material terms of the named executive officers’ offer letters and employment agreements are described in greater detail below under the section titled “Employment Agreements.” The explanations of the amounts of compensation awarded in 2011, including how each individual element of compensation was determined, are set forth in the section titled “Compensation Discussion and Analysis.”

[Table of Contents](#)

Outstanding Equity Awards at December 31, 2011

The following table presents certain information concerning outstanding equity awards held by each of our named executive officers as of December 31, 2011.

	Name	Option awards			
		Number of Securities Underlying Unexercised Options Exercisable ⁽¹⁾ (#)	Number of Securities Underlying Unexercised Options Unexercisable ⁽¹⁾ (#)	Option Exercise Price ⁽²⁾ (\$/Share)	Option Expiration Date
Paul B. Nahi		88,105 ⁽³⁾	—	2.36	6/25/2018
		550,683	302,874 ⁽⁴⁾	0.27	7/15/2019
		195,689	298,684 ⁽⁵⁾	1.63	7/14/2020
Sanjeev Kumar		118,047	108,604 ⁽⁶⁾	0.64	1/14/2020
		26,270	40,097 ⁽⁵⁾	1.63	7/14/2020
Dennis Hollenbeck		52,905	158,720 ⁽⁷⁾	2.54	1/20/2021
Jeff Loebbaka		96,655	147,527 ⁽⁸⁾	1.63	6/2/2020
Greg Steele		14,638	312 ⁽⁹⁾	0.91	2/28/2018
		10,485	2,097 ⁽¹⁰⁾	2.36	11/20/2018
		23,636	41,884 ⁽⁴⁾	0.27	7/15/2019
		27,027	41,254 ⁽⁵⁾	1.63	7/14/2020
		2,753	41,299 ⁽¹¹⁾	9.53	9/14/2021

- (1) Vesting of each stock option is contingent upon the executive officer's continued service, except as may be accelerated on certain events described below under "Potential Payments Upon Termination or Change in Control."
- (2) For more information on our methodology for determining the exercise price of the options, see "Management's Discussion and Analysis of Financial Condition and Results of Operations—Critical Accounting Policies and Significant Management Estimates—Stock-Based Compensation" appearing elsewhere in this prospectus.
- (3) The shares subject to the stock option are early exercisable and vest over a four-year period, with 1/4th of the shares vested on January 1, 2008, and the remainder vesting in 36 equal monthly installments on the first day of each succeeding calendar month thereafter.
- (4) The shares subject to the stock option vest over a four-year period commencing April 24, 2009, with 1/48th of the shares vesting on a monthly basis.
- (5) The shares subject to the stock option vest over a four-year period commencing May 21, 2010, with 1/48th of the shares vesting on a monthly basis.
- (6) The shares subject to the stock option vest over a four-year period, with 1/4th of the shares vested on November 30, 2010, and the remainder vesting in 36 equal monthly installments on the first day of each succeeding calendar month thereafter.
- (7) The shares subject to the stock option vest over a four-year period, with 1/4th of the shares vested on December 20, 2011, and the remainder vesting in 36 equal monthly installments on the first day of each succeeding calendar month thereafter.
- (8) The shares subject to the stock option vest over a four-year period, with 1/4th of the shares vested on May 3, 2011, and the remainder vesting in 36 equal monthly installments on the first day of each succeeding calendar month thereafter.
- (9) The shares subject to the stock option vest over a four-year period, with 1/4th of the shares vested on January 28, 2009, and the remainder vesting in 36 equal monthly installments on the first day of each succeeding calendar month thereafter.
- (10) The shares subject to the stock option vest over a four-year period, with 1/4th of the shares vested on August 15, 2009, and the remainder vesting in 36 equal monthly installments on the first day of each succeeding calendar month thereafter.
- (11) The shares subject to the stock option vest over a four-year period commencing September 15, 2011, with 1/48th of the shares vesting on a monthly basis.

Option Exercises and Stock Vested

The following table shows information regarding option exercises and the vesting of restricted stock held by our named executive officers during 2011.

<u>Name</u>	<u>Option Awards</u>		<u>Stock Awards</u>	
	<u>Number of Shares Acquired on Exercise(#)</u>	<u>Value Realized on Exercise⁽¹⁾ (\$)</u>	<u>Number of Shares Acquired on Vesting(#)</u>	<u>Value Realized on Vesting⁽³⁾ (\$)</u>
Paul B. Nahi	55,066	342,929	2,850 ⁽²⁾	18,525
Sanjeev Kumar	—	—	—	—
Dennis Hollenbeck	—	—	—	—
Jeff Loebbaka	—	—	—	—
Greg Steele	60,132	374,478	—	—

- (1) The value realized upon the exercise of an option represents the difference between the aggregate market price of the shares of our common stock underlying that option on the date of exercise, which we have assumed to be \$6.50 per share, the midpoint of the range listed on the cover page of this prospectus, and aggregate exercise price of the option.
- (2) More information about the restricted stock held by Mr. Nahi can be found under “Employment Agreements” below.
- (3) The value realized upon vesting was calculated by multiplying the number of shares of common stock that vested during 2011 by an assumed initial public offering price of \$6.50 per share, the midpoint of the price range set forth on the cover page of this prospectus.

Employment Agreements**Definitions**

Except as otherwise set forth below, for purposes of the employment related agreements entered into with our named executive officers, the following definitions apply:

“Cause” means (i) gross negligence or willful misconduct in the performance of duties to us where such gross negligence or willful misconduct has resulted or is likely to result in substantial and material damage to us or our subsidiaries; (ii) a material failure to comply with our written policies after having received from us notice of, and a reasonable time to cure, such failure; (iii) repeated unexplained or unjustified absence from us; (iv) conviction of a felony or a crime involving moral turpitude causing material harm to our standing and reputation; or (v) unauthorized use or disclosure of any proprietary information or trade secrets of us or any other party to whom he owes an obligation of non-disclosure as a result of his relationship with us, which use or disclosure causes or is likely to cause us material harm. Cause is determined by our board of directors acting in good faith and based on information then known to it.

“Change in Control” means (i) any sale or exchange of the capital stock by our shareholders in one transaction or series of related transactions where more than 50% of our outstanding voting power is acquired by a person or entity or group of related persons or entities, (ii) any reorganization, consolidation or merger of us where our outstanding voting securities immediately before the transaction represent or are converted into less than fifty percent 50% of the outstanding voting power of the surviving entity (or its parent corporation) immediately after the transaction, (iii) the consummation of any transaction or series of related transactions that results in the sale of all or substantially all of our assets or (iv) any “person” or “group” (as defined in the Securities Exchange Act of 1934, as amended) becoming the “beneficial owner” (as defined in Rule 13d-3 under said Act) directly or indirectly of securities representing more than 50% of the voting power of our stock then outstanding.

“Good Reason” means, without his written consent, (i) a material reduction or change in job duties, responsibilities or authority inconsistent with his position with us and his prior duties, responsibilities or authority, provided, however, that any change in his position after a Change in Control shall not constitute grounds for a termination for Good Reason so long as he remains a member of our senior management (or becomes a member of the senior management of the surviving or acquiring entity) at the same or higher base

[Table of Contents](#)

salary as immediately prior to the Change in Control with equivalent authority and responsibility, (ii) a material reduction of his then current base salary by more than 10%, excluding an across the board reduction in the salary level of other of our executives by the same percentage as part of a general salary level reduction; (iii) a relocation of the principal place for performance of his duties to us to a location more than 40 miles from our then current location; or (iv) a material breach by us of the executive's employment or executive agreement provided that he gives us written notice of the event forming the basis of the Good Reason resignation within 60 days of the date we give written notice to him of our affirmative decision to take an action set forth above, we fail to cure such basis for the Good Reason resignation within 30 days after receipt of his written notice and he terminates employment within 30 days following the expiration of the cure period.

Paul B. Nahi

On January 1, 2007, we entered into an offer letter with Mr. Nahi to serve as our President and Chief Executive Officer, on an at-will basis. The offer letter provided for an initial annual base salary of \$60,000 per year, which has subsequently increased to the current amount of \$310,000 per year. The letter also provided for the opportunity to purchase 104,845 shares of our restricted common stock and a commitment by us to issue, upon the final closing of our Series B preferred stock financing, an additional number of shares of common stock to bring his total equity ownership to 6.5% of the number of fully-diluted shares of common stock then outstanding (which issuance was subsequently completed in September 2008). The letter indicates Mr. Nahi's general eligibility for employee benefits, additional stock grants and long-term incentives. In June 2011, we entered into an executive severance agreement with Mr. Nahi that provides for the payment of severance benefits to Mr. Nahi in the event of the termination of his employment in the scenarios described below. This agreement superseded the severance provisions contained in Mr. Nahi's original offer letter.

Termination Without Cause or Resignation for Good Reason. Under the executive severance agreement, in the event that we terminate Mr. Nahi's employment without Cause or he voluntarily resigns for Good Reason, subject to signing an effective release of claims, Mr. Nahi will receive the following severance benefits: (i) six months' base salary and health insurance benefits paid over the six month severance period on our normal payroll dates, and (ii) 25% of each outstanding equity award shall automatically become immediately vested. In addition, each vested and unexercised equity award shall remain exercisable for a period of 12 months following such termination or resignation.

Termination Without Cause or Resignation with Good Reason in Connection With or Following a Change in Control. Under the executive severance agreement, in the event that we terminate Mr. Nahi's employment without Cause or he voluntarily resigns with Good Reason in connection with or within 24 months after a Change in Control, subject to signing an effective release of claims, Mr. Nahi will receive the following severance benefits: (i) six months' base salary and health insurance benefits paid over the six month severance period on our normal payroll dates, and (ii) 100% of each outstanding equity award shall automatically become immediately vested. In addition, each vested and unexercised equity award shall remain exercisable for a period of 12 months following such termination or resignation.

Sanjeev Kumar

On November 12, 2009, we entered into an offer letter with Mr. Kumar to serve as our Chief Financial Officer, on an at-will basis. The offer letter provided for an initial annual base salary of \$225,000 per year and an initial stock option grant to purchase up to 226,651 shares of our common stock. The letter also provided for a loan in the amount of \$50,000, which was evidenced by a full-recourse promissory note dated June 14, 2010. The letter indicates Mr. Kumar's eligibility for reimbursement of up to \$55,000 in qualified relocation expenses. In November 2010, in light of Mr. Kumar's achievement of certain bonus performance targets, the outstanding principal and accrued interest under the loan was forgiven and the note was cancelled. The letter also indicates Mr. Kumar's general eligibility for annual variable pay based on completion of performance objectives, stock option grants and long-term incentives. In June 2011, we entered into a change in control agreement with

[Table of Contents](#)

Mr. Kumar that provides for the payment of severance benefits to Mr. Kumar in the event of the termination of his employment following a change in control in the scenarios described below. This agreement superseded the severance provisions contained in Mr. Kumar's original offer letter.

Termination Without Cause or Resignation for Good Reason in Connection With or Following a Change in Control. Under the change in control agreement, in the event that we terminate Mr. Kumar's employment without Cause or he voluntarily resigns for Good Reason in connection with or within 24 months after a Change in Control, subject to signing an effective release of claims, Mr. Kumar will receive the following severance benefits: (i) six months' base salary and health insurance benefits paid out over the six month severance period on our normal payroll dates, and (ii) 100% of each outstanding equity award shall automatically become immediately vested.

Dennis Hollenbeck

On December 14, 2010, we entered into an offer letter with Mr. Hollenbeck to serve as our Vice President of Engineering, on an at-will basis. The offer letter provides for an initial annual base salary of \$250,000 per year and an initial stock option grant to purchase up to 211,625 shares of our common stock. The agreement indicates Mr. Hollenbeck's general eligibility for an annual cash bonus in the discretion of the Board of Directors, employee benefits and stock option grants. In June 2011, we entered into a change in control agreement with Mr. Hollenbeck that provides for the payment of severance benefits to Mr. Hollenbeck in the event of the termination of his employment following a change in control in the scenarios described below.

Termination Without Cause or Resignation for Good Reason in Connection With or Following a Change in Control. Under the change in control agreement, in the event that we terminate Mr. Hollenbeck's employment without Cause or he voluntarily resigns for Good Reason in connection with or within 24 months after a change in control, subject to signing an effective release of claims, Mr. Hollenbeck will receive the following severance benefits: (i) three months' base salary and health insurance benefits paid out over the three month severance period and (ii) 100% of each outstanding equity award shall automatically become immediately vested.

Jeff Loebbaka

On April 19, 2010, we entered into an offer letter with Mr. Loebbaka to serve as our Vice President of Worldwide Sales, on an at-will basis. The offer letter provides for an initial annual base salary of \$225,000 per year. The letter also provides for a proposed initial stock option grant to purchase up to 244,182 shares of our common stock, subject to approval of our board of directors. The letter indicates Mr. Loebbaka's eligibility for incentive compensation of up to \$145,000 during his first twelve months of employment based on completion of sales targets and reimbursement of up to \$50,000 in qualified relocation expenses. The letter also indicates Mr. Loebbaka's general eligibility for annual variable pay based on completion of performance objectives, stock option grants and long-term incentives. The letter further provides that in the event that we terminate Mr. Loebbaka's employment without Cause prior to the twelve month anniversary of his first day of employment, Mr. Loebbaka would receive the following severance benefits; three months' base salary and three months' health benefit insurance premiums paid out over the three month severance period on our normal payroll dates. Our obligation to provide these severance benefits expired in April 2011. In June 2011, we entered into a change in control agreement with Mr. Loebbaka that provides for the payment of severance benefits to Mr. Loebbaka in the event of the termination of his employment following a change in control in the scenarios described below. This agreement superseded the severance provisions contained in Mr. Loebbaka's original offer letter.

Termination Without Cause or Resignation for Good Reason in Connection With or Following a Change in Control. Under the change in control agreement, in the event that we terminate Mr. Loebbaka's employment without Cause or he voluntarily resigns for Good Reason in connection with or within 24 months after a change in control, subject to signing an effective release of claims, Mr. Loebbaka will receive the following severance benefits: (i) three months' base salary and health insurance benefits paid out over the three month severance period and (ii) 100% of each outstanding equity award shall automatically become immediately vested.

Gregory S. Steele

On November 15, 2007, we entered into an offer letter with Mr. Steele to serve as our Vice President of Operations, on an at-will basis. The offer letter provides for an initial annual base salary of \$136,000 per year, which has subsequently increased to the current amount of \$225,000 per year. The agreement indicates Mr. Steele's general eligibility for an annual cash bonus in the discretion of the Board of Directors, employee benefits and stock option grants. In June 2011, we entered into a change in control agreement with Mr. Steele that provides for the payment of severance benefits to Mr. Steele in the event of the termination of his employment following a change in control in the scenarios described below.

Termination Without Cause or Resignation for Good Reason in Connection With or Following a Change in Control. Under the change in control agreement, in the event that we terminate Mr. Steele's employment without Cause or he voluntarily resigns for Good Reason in connection with or within 24 months after a change in control, subject to signing an effective release of claims, Mr. Steele will receive the following severance benefits: (i) three months' base salary and health insurance benefits paid out over the three month severance period and (ii) 100% of each outstanding equity award shall automatically become immediately vested.

Potential Payments Upon Termination or Change in Control

The section below describes the payments that we would have made to our named executive officers in connection with certain terminations of employment and/or certain corporate transactions like a change in control, if such events had occurred on December 31, 2011. For further information, see the section above entitled "Executive Compensation—Employment Agreements."

Potential Payments Upon a Change in Control, Stock Awards Not Assumed

Pursuant to our 2006 Equity Incentive Plan, in the event that there had been a Corporate Transaction (as defined below) on December 31, 2011, and if the surviving or acquiring corporation had elected not to assume or substitute for outstanding options (or assume the repurchase rights held in respect of shares purchased under such options or awards, as applicable), the vesting of outstanding options or awards held by each of our named executive officers on such date would have accelerated (and the repurchase rights with respect to the shares issued upon exercise of such options or under the awards would have lapsed) by one calendar month for each calendar month the named executive officer had been employed by us, up to a maximum of twelve months, in addition to any other applicable vesting.

For purposes of our 2006 Equity Incentive Plan, "Corporate Transaction" means (i) a dissolution or liquidation of our company, (ii) a merger or consolidation after which our stockholders immediately prior to such merger (other than any stockholder which merges, or which owns or controls another entity that merges, with us in such merger) cease to own at least a majority of their shares of our capital stock, (iii) the sale of substantially all of our assets in one transaction or series of related transactions followed by the liquidation of our company, or (iv) the sale by our stockholders of at least a majority of the outstanding shares of our capital stock in one transaction or series of related transactions.

2011 Potential Payments Upon Termination or Change in Control

The following table shows the amounts each of our named executive officers would receive in the event of his or her termination and/or upon a change in control, assuming the event took place on December 31, 2011, the last business day of our most recently completed fiscal year. All severance benefits are contingent upon the individual's execution of a general release of all claims.

Named Executive Officer	Termination or Change in Control Event ⁽¹⁾	Salary (\$)	Bonus (\$)	Benefits (\$)	Equity Acceleration (\$) ⁽²⁾	Total (\$)
Paul B. Nahi	Termination without cause or resignation with good reason	\$155,000 ⁽³⁾	\$ —	\$ 9,217 ⁽⁴⁾	\$ 3,341,496	\$3,505,713
	Change in control—awards assumed and termination without cause or resignation with good reason ⁽⁵⁾	155,000 ⁽³⁾	—	9,217 ⁽⁴⁾	3,341,496	3,505,713
	Change in control—awards not assumed and termination without cause or resignation with good reason ⁽⁶⁾	155,000 ⁽³⁾	—	9,217 ⁽⁴⁾	3,341,496	3,505,713
Sanjeev Kumar	Change in control—awards not assumed and continued employment ⁽⁷⁾	—	—	—	—	—
	Termination without cause or resignation for good reason	—	—	—	—	—
	Change in control—awards assumed and termination without cause or resignation for good reason ⁽⁵⁾	112,500 ⁽³⁾	—	9,217 ⁽⁴⁾	831,692	953,409
Dennis Hollenbeck	Change in control—awards not assumed and termination without cause or resignation for good reason ⁽⁶⁾	112,500 ⁽³⁾	—	9,217 ⁽⁴⁾	831,692	953,409
	Change in control—awards not assumed and continued employment ⁽⁷⁾	—	—	—	—	—
	Termination without cause	—	—	—	—	—
Jeff Loebbaka	Change in control—awards assumed and termination without cause or resignation for good reason ⁽⁵⁾	62,500 ⁽⁸⁾	—	36 ⁽⁹⁾	628,531	691,067
	Change in control—awards not assumed and termination without cause or resignation for good reason ⁽⁶⁾	62,500 ⁽⁸⁾	—	36 ⁽⁹⁾	628,531	691,067
	Change in control—awards not assumed and continued employment ⁽⁷⁾	—	—	—	—	—
Gregory S. Steele	Termination without cause	—	—	—	—	—
	Change in control—awards assumed and termination without cause or resignation for good reason ⁽⁵⁾	56,250 ⁽⁸⁾	—	4,609 ⁽⁹⁾	472,270	533,129
	Change in control—awards not assumed and termination without cause or resignation for good reason ⁽⁶⁾	56,250 ⁽⁸⁾	—	4,609 ⁽⁹⁾	472,270	533,129
	Change in control—awards not assumed and continued employment ⁽⁷⁾	—	—	—	—	—

- (1) No compensation is payable where there is a change in control, awards are assumed and employment continues.
- (2) The value realized is the gain that our named executive officers would receive, calculated as the difference between an assumed initial public offering price of \$6.50 per share, the midpoint of the price range set forth on the cover page of this prospectus and the exercise price of the named executive officers' unvested options or awards subject to acceleration following a change in control event.
- (3) Represents six months' base salary calculated at a rate in effect on December 31, 2011.
- (4) Represents six months' of continued health insurance coverage for such named executive officer at the applicable benefit rate for 2011.
- (5) Represents benefits received by such named executive officer upon a change in control in which the surviving or acquiring entity elects to assume or substitute outstanding options or awards concurrent with the termination without cause of or resignation with good reason by such named executive officer.
- (6) Represents benefits received by such named executive officer upon a change in control in which the surviving or acquiring corporation elects not to assume or substitute outstanding options or awards concurrent with the termination without cause of or resignation with good reason by such named executive officer.
- (7) Represents benefits received by such named executive officer upon a change in control in which the surviving or acquiring corporation elects not to assume or substitute outstanding options or awards and such named executive officer's employment continues.
- (8) Represents three months' base salary calculated at a rate in effect on December 31, 2011.
- (9) Represents three months' of continued health insurance coverage for such named executive officer at the applicable benefit rate for 2011.

Employee Benefit Plans

2006 Equity Incentive Plan

Our board of directors adopted, and our stockholders approved, the 2006 Equity Incentive Plan, as amended, or 2006 Plan, in March 2006. The 2006 Plan provides for the grant of incentive stock options, nonstatutory stock options and rights to acquire restricted stock. Upon the execution and delivery of the underwriting agreement for this offering, no additional stock options or other stock awards will be granted under the 2006 Plan. All outstanding stock options and other stock awards previously granted under the 2006 Plan will remain subject to the terms of the 2006 Plan.

Share Reserve. There are 7,533,127 shares of common stock reserved for issuance under the 2006 Plan. As of December 31, 2011, 762,795 shares of common stock had been issued upon the exercise of stock options or pursuant to stock awards granted under the 2006 Plan, net of repurchases, options to purchase 6,255,867 shares of common stock were outstanding at a weighted-average exercise price of \$1.83 per share and 514,396 shares remained available for future grant under the 2006 Plan. Following the completion of this offering, no further grants will be made under the 2006 Plan.

Administration. Our board of directors administers our 2006 Plan. Our board of directors, however, may delegate this authority to a committee created and appointed by the board of directors to administer the 2006 Plan. Our board of directors or the authorized committee, referred to as the plan administrator, has the authority to construe, interpret, amend and suspend the 2006 Plan, as well as to determine the terms of an option or amend the terms of an option. However, no amendment may materially and adversely affect the rights under any outstanding option unless the holder consents to that amendment.

Eligibility. The 2006 Plan provides for the grant of stock awards to our employees, directors and consultants. Incentive stock options may be granted only to employees. Nonstatutory stock options and stock awards may be granted to employees, directors and consultants.

Stock Option Provisions Generally. In general, the exercise price of a stock option cannot be less than 100% of the fair market value of our common stock on the date of grant. However, an incentive stock option granted to a person who on the date of grant owns more than 10% of the voting power of all classes of our outstanding stock or any of our affiliates must have a term of no more than five years and an exercise price that is at least 110% of the fair market value on the date of grant.

Generally, an optionee may not transfer his or her stock option other than by will or by the laws of descent and distribution. Shares subject to options under the 2006 Plan generally vest and become exercisable in periodic installments. In general, the term of stock options granted under the 2006 Plan cannot exceed ten years. The aggregate fair market value, determined at the time of grant, of shares of our common stock with respect to which incentive stock options are exercisable for the first time by an optionee during any calendar year under all of our stock plans may not exceed \$100,000. Options or portions thereof that exceed such limit generally will be treated as nonstatutory stock options. Subject to capitalization adjustments, no more than 1,101,321 shares of common stock may be issued under the 2006 Plan pursuant to the exercise of incentive stock options.

Unless otherwise provided by an optionee's stock option agreement, if an optionee's service relationship with us, or any of our affiliates, ceases for any reason other than disability, death, or for cause, the optionee generally may exercise the vested portion of any options for a period of three months following the cessation of service. If an optionee's service relationship with us, or any of our affiliates, ceases due to disability or death, or an optionee dies within three months following cessation of service, the optionee or a beneficiary may generally exercise any vested options for a period of twelve months after such disability or death. In the event of a termination for cause, options generally terminate immediately upon the termination of the optionee's service. In no event may an option be exercised beyond the expiration of its term.

[Table of Contents](#)

Rights to Acquire Restricted Stock. Rights to acquire restricted stock may be granted pursuant to restricted stock purchase agreements adopted under the 2006 Plan. The purchase price for restricted stock awards may be paid using cash, cancellation of indebtedness, promissory note, past services provided to us or our affiliates, or other legal consideration permitted by our board of directors or the authorized committee in its discretion. The purchase price of restricted stock awards cannot be less than 100% of the fair market value of our common stock on the date of grant or the date the purchase is consummated, except in the case of a person who on the date of grant owns or is deemed to own more than 10% of the total combined voting power of all classes of our outstanding stock or any of our affiliates, in which case the purchase price must be at least 110% of the fair market value on the date of grant or the date the purchase is consummated. Shares of common stock acquired under restricted stock awards rights may, but need not, be subject to a share repurchase option in our favor in accordance with a vesting schedule to be determined by our board, in which case, if a participant's service relationship with us terminates, we may repurchase or otherwise reacquire any or all of the shares of common stock subject to the restricted stock award that has not vested as of the date of termination. A holder of a restricted stock award may not transfer his or her stock award other than by will or by the laws of descent and distribution.

Changes to Capital Structure. In the event that there is a specified type of change in our capital structure, such as a stock split or recapitalization, appropriate adjustments will be made to the number of shares subject to the 2006 Plan and to the number of shares and price per share of all outstanding options and stock awards.

Corporate Transactions. In the event of certain specified significant corporate transactions involving us, such as our liquidation or dissolution, a merger or consolidation that results in a material change in the ownership of our company, the sale of substantially all of our assets, or the sale of at least a majority of our outstanding capital stock, the surviving or acquiring corporation may assume or substitute equivalent options or stock awards for the outstanding stock options and awards granted under the 2006 Plan. If, in the event of such a corporate transaction (and in the case of a merger, consolidation, or sale of substantially all of our assets, our stockholders after such event cease to hold at least 80% of the shares of our capital stock held by them prior to such event), the surviving or acquiring corporation elects not to assume or substitute equivalent options or stock awards for outstanding options or stock awards, then the vesting of outstanding options and awards under the 2006 Plan will accelerate, prior to the consummation of such corporate transaction, by one calendar month for each calendar month the optionee or holder of stock awards has been employed by us, up to a maximum of twelve months, in addition to any other applicable vesting. Options or stock awards not exercised prior to the consummation of such corporate transaction shall expire on the occurrence of such corporate transaction, as the board of directors or authorized committee shall determine.

2011 Equity Incentive Plan

Our board of directors adopted the 2011 Equity Incentive Plan, or 2011 Incentive Plan, in June 2011 as a successor to the 2006 Plan. Subject to stockholder approval, we expect the 2011 Incentive Plan will become effective immediately upon the execution and delivery of the underwriting agreement for this offering. The 2011 Incentive Plan will terminate ten years after the effective date of this offering, unless sooner terminated by our board of directors. Our board of directors may amend or suspend the 2011 Incentive Plan at any time, although no such action may impair the rights under any then-outstanding award without the holder's consent.

Stock Awards. The 2011 Incentive Plan provides for the grant of incentive stock options, nonstatutory stock options, stock appreciation rights, restricted stock awards, restricted stock unit awards, performance-based stock awards, and other forms of equity compensation, or collectively, stock awards, all of which may be granted to employees, including officers, and to non-employee directors and consultants. Additionally, the 2011 Incentive Plan provides for the grant of performance cash awards. Incentive stock options may be granted only to employees. All other awards may be granted to employees, including officers, and to non-employee directors and consultants.

Share Reserve. Initially, the aggregate number of shares of our common stock that may be issued pursuant to stock awards under the 2011 Incentive Plan after the 2011 Incentive Plan becomes effective is 2,643,171

[Table of Contents](#)

shares. Then, the number of shares of our common stock reserved for issuance under the 2011 Incentive Plan will automatically increase on January 1st each year, starting on January 1, 2013 and continuing through January 1, 2021, by 4.5% of the total number of shares of our common stock outstanding on December 31 of the preceding calendar year, or such lesser number of shares of common stock as determined by our board of directors. The maximum number of shares that may be issued pursuant to the exercise of incentive stock options under the 2011 Incentive Plan is 13,215,859 shares.

No person may be granted stock awards covering more than 2,000,000 shares of our common stock under our 2011 Incentive Plan during any calendar year pursuant to stock options, stock appreciation rights and other stock awards whose value is determined by reference to an increase over an exercise or strike price of at least 100% of the fair market value on the date the stock award is granted. Additionally, no person may be granted in a calendar year a performance stock award covering more than 1,000,000 shares or a performance cash award having a maximum value in excess of \$1,000,000. Such limitations are designed to help assure that any deductions to which we would otherwise be entitled with respect to such awards will not be subject to the \$1,000,000 limitation on the income tax deductibility of compensation paid to any covered executive officer imposed by Section 162(m) of the Code.

If a stock award granted under the 2011 Incentive Plan expires or otherwise terminates without being exercised in full, or is settled in cash, the expiration, termination or settlement shall not reduce (or otherwise offset) the number of shares of common stock that may be available for issuance under the 2011 Incentive Plan. In addition, the following types of shares under the 2011 Incentive Plan may become available for the grant of new stock awards under the 2011 Incentive Plan: (1) shares that are forfeited to or repurchased by us prior to becoming fully vested; (2) shares withheld to satisfy income or employment withholding taxes; or (3) shares used to pay the exercise price of an option. Shares issued under the 2011 Incentive Plan may be previously unissued shares or reacquired shares bought by us on the open market. As of the date hereof, no awards have been granted and no shares of our common stock have been issued under the 2011 Incentive Plan.

Administration. Our board of directors, or a duly authorized committee thereof, has the authority to administer the 2011 Incentive Plan. Our board of directors has delegated its authority to administer the 2011 Incentive Plan to our compensation committee under the terms of the compensation committee's charter. Our board of directors may also delegate to one or more of our officers the authority to (1) designate employees (other than other officers) to be recipients of certain stock awards, and (2) determine the number of shares of common stock to be subject to such stock awards, provided that our board of directors must specify the total number of shares of common stock that may be subject to stock awards granted by such officer and that such officer may not grant a stock award to himself or herself. Subject to the terms of the 2011 Incentive Plan, our board of directors or the authorized committee or officer, referred to as the plan administrator, determines recipients, dates of grant, the numbers and types of stock awards to be granted and the terms and conditions of the stock awards, including the period of their exercisability and vesting schedule applicable to a stock award. Subject to the limitations set forth below, the plan administrator will also determine the exercise price, strike price or purchase price of awards granted and the types of consideration to be paid for the award.

The plan administrator has the authority to reduce the exercise price (or strike price) of any outstanding option or stock appreciation right, cancel and re-grant any outstanding option or stock appreciation right or take any other action that is treated as a repricing under U.S. generally accepted accounting principles, with the consent of any adversely affected participant.

Stock Options. Incentive and nonstatutory stock options are granted pursuant to stock option agreements adopted by the plan administrator. The plan administrator determines the exercise price for a stock option, within the terms and conditions of the 2011 Incentive Plan, provided that the exercise price of a stock option generally cannot be less than 100% of the fair market value of our common stock on the date of grant. Options granted under the 2011 Incentive Plan vest at the rate specified by the plan administrator.

[Table of Contents](#)

The plan administrator determines the term of stock options granted under the 2011 Incentive Plan, up to a maximum of 10 years. Unless the terms of an optionee's stock option agreement provide otherwise, if an optionee's service relationship with us, or any of our affiliates, ceases for any reason other than disability, death or cause, the optionee may generally exercise any vested options for a period of three months following the cessation of service. The option term may be extended in the event that exercise of the option or sale of shares received upon exercise of the option following such a termination of service is prohibited by applicable securities laws or our insider trading policy. If an optionee's service relationship with us, or any of our affiliates, ceases due to disability or death, or an optionee dies within a certain period following cessation of service, the optionee or a beneficiary may generally exercise any vested options for a period of 12 months. In the event of a termination for cause, options generally terminate immediately upon the occurrence of the event giving rise to the right to terminate the individual for cause. In no event may an option be exercised beyond the expiration of its term.

Acceptable consideration for the purchase of common stock issued upon the exercise of a stock option will be determined by the plan administrator and may include (1) cash, check, bank draft or money order, (2) a broker-assisted cashless exercise, (3) the tender of shares of our common stock previously owned by the optionee, (4) a net exercise of the option if it is a nonstatutory stock option, and (5) other legal consideration approved by the plan administrator.

Unless the plan administrator provides otherwise, options generally are not transferable except by will, the laws of descent and distribution, or pursuant to a domestic relations order. An optionee may designate a beneficiary, however, who may exercise the option following the optionee's death.

Tax Limitations on Incentive Stock Options. The aggregate fair market value, determined at the time of grant, of our common stock with respect to incentive stock options that are exercisable for the first time by an optionee during any calendar year under all of our stock plans may not exceed \$100,000. Options or portions thereof that exceed such limit will generally be treated as nonstatutory stock options. No incentive stock option may be granted to any person who, at the time of the grant, owns or is deemed to own stock possessing more than 10% of our total combined voting power or that of any of our affiliates unless (1) the option exercise price is at least 110% of the fair market value of the stock subject to the option on the date of grant, and (2) the term of the incentive stock option does not exceed five years from the date of grant.

Restricted Stock Awards. Restricted stock awards are granted pursuant to restricted stock award agreements adopted by the plan administrator. Restricted stock awards may be granted in consideration for (1) cash, check, bank draft or money order, (2) past services rendered to us or our affiliates, or (3) any other form of legal consideration (including future services) that may be acceptable to our board of directors and permissible under applicable law. Common stock acquired under a restricted stock award may, but need not, be subject to a share repurchase option in our favor in accordance with a vesting schedule to be determined by the plan administrator. Rights to acquire shares under a restricted stock award may be transferred only upon such terms and conditions as set by the plan administrator.

Restricted Stock Unit Awards. Restricted stock unit awards are granted pursuant to restricted stock unit award agreements adopted by the plan administrator. The plan administrator will determine the vesting terms of restricted stock unit awards. The plan administrator will determine the consideration to be paid, if any, by the participant upon delivery for each share subject to a restricted stock unit award, which may be paid in any form of legal consideration acceptable to the plan administrator. A restricted stock unit award may be settled by cash, delivery of stock, a combination of cash and stock as deemed appropriate by the plan administrator, or in any other form of consideration set forth in the restricted stock unit award agreement. Additionally, dividend equivalents may be credited in respect of shares covered by a restricted stock unit award. Except as otherwise provided in the applicable award agreement, restricted stock units that have not vested will be forfeited upon the participant's cessation of continuous service for any reason.

Stock Appreciation Rights. Stock appreciation units are granted pursuant to stock appreciation right agreements adopted by the plan administrator. The plan administrator determines the strike price for a stock

[Table of Contents](#)

appreciation right, which generally cannot be less than 100% of the fair market value of our common stock on the date of grant. Upon the exercise of a stock appreciation right, we will pay the participant an amount equal to the product of (1) the excess of the per share fair market value of our common stock on the date of exercise over the strike price, multiplied by (2) the number of shares of common stock with respect to which the stock appreciation right is exercised. A stock appreciation right granted under the 2011 Incentive Plan vests at the rate specified in the stock appreciation right agreement as determined by the plan administrator. The appreciation distribution with respect to a stock appreciation right may be paid in common stock, in cash, in any combination of the two or in any other form of consideration, as determined by our board of directors and specified in the stock appreciation right agreement.

The plan administrator determines the term of stock appreciation rights granted under the 2011 Incentive Plan, up to a maximum of ten years. Unless the terms of a participant's stock appreciation right agreement provides otherwise, if a participant's service relationship with us, or any of our affiliates, ceases for any reason other than cause, disability or death, the participant may generally exercise any vested stock appreciation right for a period of three months following the cessation of service. The stock appreciation right term may be further extended in the event that exercise of the stock appreciation right or the sale of shares received upon exercise of the stock appreciation right following such a termination of service is prohibited by applicable securities laws. If a participant's service relationship with us, or any of our affiliates, ceases due to disability or death, or a participant dies within a certain period following cessation of service, the participant or a beneficiary may generally exercise any vested stock appreciation right for a period of 12 months. In the event of a termination for cause, stock appreciation rights generally terminate immediately upon the occurrence of the event giving rise to the right to terminate the individual for cause. In no event may a stock appreciation right be exercised beyond the expiration of its term.

Performance Awards. The 2011 Incentive Plan permits the grant of performance-based stock and cash awards that may qualify as performance-based compensation not subject to the \$1,000,000 limitation on the income tax deductibility of compensation paid to a covered executive officer imposed by Section 162(m) of the Code. To help assure that the compensation attributable to performance-based awards will so qualify, our compensation committee can structure such awards so that stock or cash will be issued or paid pursuant to such award only after the achievement of certain pre-established performance goals during a designated performance period.

The performance criteria used to establish performance goals for a performance plan may be based on one or more of the following: (1) earnings (including earnings per share and net earnings); (2) earnings before interest, taxes and depreciation; (3) earnings before interest, taxes, depreciation and amortization; (4) total stockholder return; (5) return on equity or average stockholder's equity; (6) return on assets, investment, or capital employed; (7) stock price; (8) margin (including gross margin); (9) income (before or after taxes); (10) operating income; (11) operating income after taxes; (12) pre-tax profit; (13) operating cash flow; (14) sales or revenue targets; (15) increases in revenue or product revenue; (16) expenses and cost reduction goals; (17) improvement in or attainment of working capital levels; (18) economic value added (or an equivalent metric); (19) market share; (20) cash flow; (21) cash flow per share; (22) share price performance; (23) debt reduction; (24) implementation or completion of projects or processes; (25) customer satisfaction; (26) stockholders' equity; (27) capital expenditures; (28) debt levels; (29) operating profit or net operating profit; (30) workforce diversity; (31) growth of net income or operating income; (32) billings; and (33) to the extent that an award is not intended to comply with Section 162(m) of the Code, other measures of performance selected by our board of directors.

The performance goals may be based on a company-wide basis, with respect to one or more business units, divisions, affiliates, or business segments, and in either absolute terms or relative to the performance of one or more comparable companies or the performance of one or more relevant indices. Unless specified otherwise (1) in the award agreement at the time the award is granted or (2) in such other document setting forth the performance goals at the time the goals are established, the plan administrator will appropriately make

[Table of Contents](#)

adjustments in the method of calculating the attainment of performance goals as follows: (1) to exclude restructuring and/or other nonrecurring charges; (2) to exclude exchange rate effects, as applicable, for non-U.S. dollar denominated goals; (3) to exclude the effects of changes to U.S. generally accepted accounting principles; (4) to exclude the effects of any statutory adjustments to corporate tax rates; and (5) to exclude the effects of any “extraordinary items” as determined under generally accepted accounting principles. In addition, the plan administrator retains the discretion to reduce or eliminate the compensation or economic benefit due upon attainment of the goals and to define the manner of calculating the performance criteria it selects to use for a performance period. The performance goals may differ from participant to participant and from award to award.

Other Stock Awards. The plan administrator may grant other awards based in whole or in part by reference to our common stock. The plan administrator will set the number of shares under the stock award and all other terms and conditions of such awards.

Changes to Capital Structure. In the event that there is a specified type of change in our capital structure, such as a stock split or recapitalization, the plan administrator shall appropriately and proportionately adjust: (a) the class(es) and maximum number of shares reserved for issuance under the 2011 Incentive Plan, (b) the class(es) and maximum number of shares that may be issued upon the exercise of incentive stock options, (c) the class(es) and maximum number of shares subject to stock awards that can be granted in a calendar year (as established under the 2011 Incentive Plan pursuant to Section 162(m) of the Code) and (d) the class(es) and number of shares and price per share of stock subject to outstanding stock awards.

Corporate Transactions. In the event of certain specified significant corporate transactions, unless otherwise provided in the instrument evidencing the stock award or any other written agreement between us or any affiliate and the holder of the stock award, the plan administrator has the discretion to take any of the following actions with respect to stock awards:

- arrange for the assumption, continuation or substitution of a stock award by a surviving or acquiring entity or parent company;
- arrange for the assignment of any reacquisition or repurchase rights held by us to the surviving or acquiring entity or parent company;
- accelerate the vesting of the stock award and provide for its termination prior to the effective time of the corporate transaction;
- arrange for the lapse of any reacquisition or repurchase right held by us;
- cancel or arrange for the cancellation of the stock award in exchange for such cash consideration, if any, as our board of directors may deem appropriate; or
- make a payment equal to the excess of (a) the value of the property the participant would have received upon exercise of the stock award over (b) the exercise price otherwise payable in connection with the stock award.

Our board of directors is not obligated to treat all stock awards, even those that are of the same type, in the same manner.

Change in Control. The plan administrator may provide, in an individual award agreement or in any other written agreement between a participant and us, that the stock award will be subject to additional acceleration of vesting and exercisability in the event of a certain specified change in control. However, in the absence of such a provision, no such acceleration of the stock award will occur.

2011 Employee Stock Purchase Plan

Our board of directors adopted the 2011 Employee Stock Purchase Plan, or ESPP, in June 2011. Subject to stockholder approval, we expect the ESPP will become effective immediately upon the execution and delivery of the underwriting agreement for this offering.

[Table of Contents](#)

Share Reserve. The ESPP initially authorizes the issuance of 669,603 shares of our common stock pursuant to purchase rights granted to our employees or to employees of any of our designated affiliates. The number of shares of our common stock reserved for issuance will automatically increase on January 1 each year, starting January 1, 2013 and continuing through January 1, 2021, in an amount equal to the lower of (1) 1% of the total number of shares of our common stock outstanding on December 31 of the preceding calendar year, (2) 330,396 shares of our common stock or (3) a number of shares of common stock as determined by our board of directors. If a purchase right granted under the ESPP terminates without having been exercised, the shares of our common stock not purchased under such purchase right will be available for issuance under the ESPP.

Administration. Our board of directors, or a duly authorized committee thereof, has the authority to administer the ESPP. Our board of directors has delegated its authority to administer the ESPP to our compensation committee. Our board of directors or the authorized committee is referred to as the plan administrator.

Purchase Rights. The ESPP is implemented through a series of offerings of purchase rights to eligible employees. Purchase rights are generally not transferable. Under the ESPP, we may specify offerings with a duration of not more than 27 months, and may specify one or more shorter purchase periods within each offering. Each offering will have one or more purchase dates on which shares of our common stock will be purchased for the employees who are participating in the offering. An offering may be terminated early under certain circumstances such as a material change in control of Enphase. The plan administrator has the discretion to structure an offering so that if the fair market value of the shares of our common stock on the first day of a new purchase period within such offering is less than or equal to the fair market value of the shares of our common stock on the first day of the offering, then (a) that offering shall terminate immediately, and (b) the participants in such terminated offering shall be automatically enrolled in a new offering beginning on the first day of such new purchase period.

Payroll Deductions. Generally, all regular employees, including executive officers, employed by us or by any of our designated affiliates, may participate in the ESPP and may contribute, normally through payroll deductions, up to 15% of their earnings toward the purchase of our common stock under the ESPP. Unless otherwise determined by the plan administrator, common stock will be purchased for participating employees at a price per share equal to the lower of (a) 85% of the fair market value of a share of our common stock on the first date of an offering, or (b) 85% of the fair market value of a share of our common stock on the date of purchase.

Limitations. Employees may have to satisfy one or more of the following service requirements before participating in the ESPP, as determined by the plan administrator: (a) customary employment with us or one of our affiliates for more than 20 hours per week and more than five months per calendar year or (b) continuous employment with us or one of our affiliates for a minimum period of time prior to the first date of an offering, provided that such minimum period may not to exceed two years. No employee may purchase shares under the ESPP at a rate in excess of \$25,000 worth of our common stock, based on the fair market value per share of our common stock at the beginning of an offering, for each calendar year in which such purchase right is outstanding. Finally, no employee will be eligible for the grant of any purchase rights under the ESPP if, immediately after such rights are granted, such employee owns our stock possessing five percent or more of the total combined voting power or value of all classes of our outstanding capital stock.

Changes to Capital Structure. In the event that there is a specified type of change in our capital structure such as a stock split or recapitalization, appropriate adjustments will be made to (a) the class(es) and maximum number of shares reserved under the ESPP, (b) the class(es) and maximum number of shares by which the share reserve may increase automatically each year, (c) the class(es) and number of shares subject to, and purchase price applicable to, all outstanding purchase rights, and (d) any limits on the class(es) and number of shares that may be purchased in an ongoing offering.

[Table of Contents](#)

Corporate Transactions. In the event of certain significant corporate transactions, such as an acquisition of the company that results in a material change in the ownership of the company, any then-outstanding purchase rights under the ESPP may be assumed, continued or substituted for by any surviving or acquiring entity or its parent company, provided that the rights of any participant under any such assumption, continuation or substitution will not be impaired. If the surviving or acquiring entity or its parent company elects not to assume, continue or substitute for such purchase rights, then the participants' accumulated contributions will be used to purchase shares of our common stock within 10 business days prior to such corporate transaction, and such purchase rights will terminate immediately thereafter.

Plan Amendments. The plan administrator has the authority to amend, suspend or terminate the ESPP, provided any such action will not be taken without the consent of an adversely affected participant except as necessary to comply with any laws, listing requirements or governmental regulations or to maintain favorable tax, listing or regulatory treatment. We will obtain stockholder approval of any amendment to our ESPP as required by applicable law.

401(k) Plan

We offer a 401(k) plan to all employees who meet specified eligibility requirements. Eligible employees may contribute up to the lesser of 100% of their eligible compensation or the maximum amount as permitted each calendar year under the Code. We make a nonelective employer contribution each year equal to 3% of each participant's eligible compensation during the applicable plan year.

Indemnification of Directors and Officers and Limitation of Liability

Our certificate of incorporation includes a provision that eliminates, to the fullest extent permitted by law, the personal liability of a director for monetary damages resulting from breach of his fiduciary duty as a director.

Our bylaws, as in effect upon completion of this offering, provide that:

- we are required to indemnify our directors and officers to the fullest extent permitted by the Delaware General Corporation Law, subject to very limited exceptions;
- we may indemnify our other employees and agents as provided in indemnification contracts entered into between us and our employees and agents;
- we are required to advance expenses, as incurred, to our directors and officers in connection with a legal proceeding to the fullest extent permitted by the Delaware General Corporation Law, subject to very limited exceptions; and
- the rights conferred in the bylaws are not exclusive.

In addition to the indemnification required in our certificate of incorporation and bylaws, we have entered into indemnity agreements with each of our current directors and officers. These agreements provide for the indemnification of our directors and officers for all reasonable expenses and liabilities incurred in connection with any action or proceeding brought against them by reason of the fact that they are or were our agents. We have also obtained directors' and officers' insurance to cover our directors, officers and some of our employees for liabilities, including liabilities under securities laws. We believe that these indemnification provisions and agreements and this insurance are necessary to attract and retain qualified directors and officers.

A stockholder's investment may be adversely affected to the extent we pay the costs of settlement and damage awards against directors and officers as required by these indemnification provisions. At present, there is no pending litigation or proceeding involving any of our directors, officers or employees regarding which indemnification by us is sought, nor are we aware of any threatened litigation that may result in claims for indemnification.

Compensation Risk Assessment

In 2011, at the direction of our compensation committee, Compensia, assisted by management, conducted a review of our compensation policies and practices and their risk profiles. Compensia's findings were presented to our compensation committee for consideration, and then presented to the full board of directors. After consideration of the information presented, our board of directors concluded that our compensation programs are designed with an appropriate balance of risk and reward in relation to our overall business strategy and do not encourage excessive or unnecessary risk-taking behavior. These compensation plans and programs operate within our larger corporate governance and review structure that serves and supports risks mitigation. Our board of directors has concluded that any risks arising from our compensation policies and practices are not reasonably likely to have a material adverse effect on our business.

CERTAIN RELATIONSHIPS AND RELATED PARTY TRANSACTIONS

The following is a summary of transactions since January 1, 2009 to which we were or are a party in which the amount involved exceeded or exceeds \$120,000 and in which any of our directors, executive officers, holders of more than 5% of any class of our voting securities or any member of the immediate family of any of the foregoing persons, had or will have a direct or indirect material interest, other than compensation arrangements with directors and executive officers, which are described where required under the “Executive Compensation” and “Management—Non-Employee Director Compensation” sections of this prospectus.

Private Placement Financings

Preferred Stock Financings

The following table summarizes purchases of our Series D Preferred Stock and Series E preferred stock since January 1, 2009 by holders of more than 5% of our capital stock and their affiliated entities and by certain of our directors and executive officers.

Name	Series D Preferred Stock	Aggregate Purchase Price of Series D Preferred Stock	Series E Preferred Stock	Aggregate Purchase Price of Series E Preferred Stock
Applied Ventures, LLC ⁽¹⁾	852,938	\$ 1,820,000	247,854	\$ 1,530,354
Funds affiliated with Third Point LLC ⁽²⁾	1,818,659	3,703,260	757,357	4,676,240
RockPort Capital Partners II, L.P. ⁽³⁾	2,386,038	5,002,630	714,840	4,413,711
Madrone Partners, L.P. ⁽⁴⁾	3,280,532	7,000,000	585,912	3,617,658
Funds affiliated with Bay Partners ⁽⁵⁾	468,647	1,000,000	971,753	6,000,000
KPCB Holdings, Inc., as nominee ⁽⁶⁾			2,024,488	12,499,999
Robert Schwartz ⁽⁷⁾	23,432	50,000	3,562	21,999
Paul B. Nahi ⁽⁸⁾	23,432	50,000		
Martin Fornage ⁽⁹⁾	46,864	100,000	1,619	10,000
Raghuveer R. Belur ⁽¹⁰⁾	23,432	50,000	1,619	10,000
Approximate Price Per Share	\$2.134		\$ 6.174	
Dates of Purchase	4/24/2009		3/15/2010 4/5/2010 5/21/2010	

- (1) These shares are held by Applied Ventures, LLC, and include Series E preferred stock purchased on March 15, 2010.
- (2) Includes 1,185,150 shares of Series D preferred stock held by Third Point Offshore Master Fund L.P., 169,384 shares of Series D preferred stock held by Third Point Partners L.P., 324,167 shares of Series D preferred stock held by Third Point Partners Qualified L.P. and 139,958 shares of Series D preferred stock held by Third Point Ultra Master Fund L.P. Includes 510,740 shares of Series E preferred stock held by Third Point Offshore Master Fund L.P., 89,631 shares of Series E preferred stock held by Third Point Partners L.P., 86,065 shares of Series E preferred stock held by Third Point Partners Qualified L.P. and 70,921 shares of Series E preferred stock held by Third Point Ultra Master Fund L.P., purchased on March 15, 2010. Robert Schwartz, one of our directors, is Managing Partner of Third Point Ventures, but does not have any voting or dispositive power with respect to the shares of stock held by the funds affiliated with Third Point Ventures. Mr. Schwartz disclaims beneficial ownership of these shares except to the extent of his pecuniary interest therein.
- (3) These shares are held by RockPort Capital Partners II, L.P., and include Series E preferred stock purchased on March 15, 2010. Stoddard M. Wilson, one of our directors, is a General Partner of RockPort Capital Partners, and as such may be deemed to share voting and dispositive power with respect to all shares of stock held by RockPort Capital Partners II, L.P. Mr. Wilson disclaims beneficial ownership of such shares except to the extent of his pecuniary interest therein.
- (4) These shares are held by Madrone Partners, L.P., and include Series E preferred stock purchased on March 15, 2010. Jameson J. McJunkin is one of our directors and is a Managing Member of Madrone Capital Partners, and as such may be deemed to share voting and dispositive power with respect to all shares of stock held by Madrone Partners, L.P. Mr. McJunkin disclaims beneficial ownership of such securities except to the extent of his pecuniary interest therein.
- (5) Includes 466,304 shares of Series D preferred stock held by Bay Partners XI, L.P. and 2,343 shares of Series D preferred stock held by Bay Partners XI Parallel Fund, L.P. Includes 966,895 shares of Series E preferred stock held by Bay Partners XI, L.P. and 4,858 shares of Series E preferred stock held by Bay Partners XI Parallel Fund, L.P., purchased on March 15, 2010. Neal Dempsey is one of our directors and is a Managing Member with Bay Partners, and as such may be deemed to

Table of Contents

share voting and dispositive power with respect to all shares of stock held by funds affiliated with Bay Partners. Mr. Dempsey disclaims beneficial ownership of such securities except to the extent of his pecuniary interest therein.

- (6) Includes 1,929,945 shares of Series E preferred stock held by KPCB Green Growth Fund, LLC, 1,323 shares of Series E preferred stock held directly by Benjamin Kortlang and 93,220 shares of Series E preferred stock in the aggregate beneficially owned by individuals and entities affiliated with KPCB Green Growth Fund, LLC, purchased on May 21, 2010. The managing member for KPCB Green Growth Fund, LLC is KPCB GGF Associates, LLC. Benjamin Kortlang is one of our directors and is a member of the KPCB Green Growth Associates, LLC. The shares held by KPCB Green Growth Fund, LLC, Benjamin Kortlang and affiliated individuals and entities are held for convenience in the name of "KPCB Holdings, Inc. as nominee," for the accounts of the individual managers, Benjamin Kortlang and other individuals and entities that each exercise their own voting and dispositive control over the shares for their own accounts. KPCB Holdings, Inc. has no voting, dispositive or pecuniary interest in any such shares.
- (7) These shares are held by Mr. Schwartz, a member of our board of directors and Managing Partner of Third Point Ventures, and include Series E preferred stock purchased on April 5, 2010.
- (8) These shares are held by Mr. Nahi, our President, Chief Executive Officer and a member of our board of directors.
- (9) These shares are held by Mr. Fornage, our Chief Technology Officer, and include Series E preferred stock purchased on April 5, 2010.
- (10) These shares are held by Mr. Belur, our Vice President of Products and a member of our board of directors, and include Series E preferred stock purchased on April 5, 2010.

2009 Bridge Loan Financing

On March 31, 2009, we sold secured convertible promissory notes to purchase shares of our equity securities to five of our existing investors for an aggregate purchase price of \$1.5 million. The notes accrued interest at a rate of 8% per year and were due and payable by December 31, 2009. On April 24, 2009, the notes, and accrued interest of \$8,000, were converted into 831,375 shares of Series D convertible preferred stock, representing a purchase price discount of approximately 15% to such investors.

The following table summarizes the participation in the 2009 bridge financing by holders of more than 5% of our capital stock and their affiliated entities:

Name	Aggregate Principal Amount	Aggregate Shares of Series D Preferred Stock Issued Upon Conversion of 2009 Convertible Promissory Notes
Funds affiliated with Third Point LLC ⁽¹⁾	\$ 1,000,000	554,250
RockPort Capital Partners II, L.P. ⁽²⁾	500,000	277,125

- (1) Consists of: (a) 359,918 shares of Series D preferred stock issued to Third Point Offshore Master Fund L.P. upon the conversion of a principal amount of \$649,377 and \$3,415.90 in interest; (b) 51,844 shares of Series D preferred stock issued to Third Point Partners L.P. upon the conversion of a principal amount of \$93,540 and \$492.05 in interest; (c) 100,040 shares of Series D preferred stock issued to Third Point Partners Qualified L.P. upon the conversion of a principal amount of \$180,496 and \$949.46 in interest; and (d) 42,448 shares of Series D preferred stock issued to Third Point Ultra Master Fund L.P. upon the conversion of a principal amount of \$76,587 and \$402.87 in interest. Robert Schwartz, a member of our board of directors, is Managing Partner of Third Point Ventures, but does not have any voting or dispositive power with respect to the shares of stock held by the funds affiliated with Third Point Ventures. Mr. Schwartz disclaims beneficial ownership of these shares except to the extent of his pecuniary interest therein.
- (2) Consists of 277,125 shares of Series D preferred stock issued to RockPort Capital Partners II, L.P. upon the conversion of a principal amount of \$500,000 and \$2,630.14 in interest. Stoddard M. Wilson, a member of our board of directors, is a General Partner of RockPort Capital Partners, and as such may be deemed to share voting and dispositive power with respect to all shares of stock held by RockPort Capital Partners II, L.P. Mr. Wilson disclaims beneficial ownership of such shares except to the extent of his pecuniary interest therein.

Material Rights of Preferred Stock

The following is a brief description of the material rights of each series of our preferred stock issued to holders of more than 5% of our capital stock and their affiliated entities and by certain of our directors and executive officers. We anticipate that all outstanding shares of our preferred stock will automatically convert into shares of our common stock immediately prior to the closing of this offering pursuant to the terms of our certificate of incorporation. However, in the event that the requirements for such automatic conversion are not

[Table of Contents](#)

satisfied, we will solicit the requisite stockholder approval for the conversion of all outstanding shares of convertible preferred stock effective immediately prior to the closing of this offering.

Dividends—The holders of Series E, D, C, B and A convertible preferred stock are entitled to receive dividends, if, when and as declared by the board of directors, in an amount per share equal to the following (in order of right of payment):

	<u>Dividend Per Share</u>
Series E	\$ 0.494
Series D	0.171
Series C	0.933
Series B	0.481
Series A	0.232

No dividends have been declared on the Series E, D, C, B and A convertible preferred stock.

Conversion—The Series E, D, C, B and A convertible preferred stock will be automatically converted into common stock: (a) immediately prior to the closing of a firmly underwritten public offering pursuant to the Securities Act if aggregate gross proceeds to the company in such offering equal or exceed \$30,000,000 and the public offering price is not less than \$6.174 per share, or a “Qualified Public Offering”; and (b) upon our receipt of the written consent of the holders of (i) 60% of the Series E convertible preferred stock voting as a separate series, with respect to the conversion of all outstanding shares of Series E convertible preferred stock, (ii) a majority of the Series E convertible preferred stock voting as a separate series in connection with an initial public offering that is not a Qualified Public Offering, or (iii) a majority of the holders of the Series A, B, C and D convertible preferred stock voting together on an as-converted basis with respect to the conversion of all outstanding shares of Series A, B, C and D convertible preferred stock. Upon such conversion, each share of Series E, D, C, B and A convertible preferred stock will be converted into the number of shares of common stock as set forth below:

	<u>Shares of Common Stock</u>
Series E	1
Series D	1
Series C	2.514
Series B	1.898
Series A	1.226

Redemption—The Series E, D, C, B, and A convertible preferred stock are not redeemable.

Liquidation Rights—In the event of any liquidation, dissolution, or winding-up of Enphase, holders of Series E, D, C, B and A convertible preferred stock are entitled to receive, in addition to all declared but unpaid dividends, an amount per share equal to the following (in order of right of payment):

	<u>Liquidation Preference Per Share</u>
Series E	\$ 6.174
Series D	5.335
Series C	11.665
Series B	6.015
Series A	2.906

[Table of Contents](#)

Voting—The holders of Series E, D, C, B and A convertible preferred stock are entitled to the number of votes equal to the number of shares of common stock into which the preferred stock is convertible, subject to certain limitations. The primary holders of Series E, D, C and B convertible preferred stock are entitled to elect the following number of members to our board of directors:

	<u>Number of Directors</u>
Series E	2
Series D	1
Series C	1
Series B	1

Protective Provisions—We cannot, without the consent of at least 60% of the then outstanding convertible preferred stock voting together as a single class on an as-converted basis, (i) change the rights, preferences, or privileges of the convertible preferred stock or any series of convertible preferred stock so as to materially and adversely affect the convertible preferred stock or any series of convertible preferred stock, (ii) increase or decrease the total number of authorized shares of convertible preferred stock, (iii) authorize or issue any shares of a new class or series of capital stock (or rights to acquire such new class or series of capital stock) having rights, preferences or privileges senior or equivalent to the Series E, D, C, B or A convertible preferred stock, (iv) cause or effect a change of control, liquidation, dissolution or winding up of Enphase, (v) redeem any shares of common stock except for certain permitted repurchases, (vi) increase or decrease the authorized number of directors on our board of directors unless approved unanimously by our board of directors, (vii) declare or pay any dividends or declare or make any other distribution, purchase, redemption or acquisition on any of our capital stock, except for certain permitted repurchases (viii) amend or alter our certificate of incorporation or bylaws, or (ix) consummate a public offering of the common stock of Enphase.

In addition, we cannot, without the consent of (i) at least 60% of the then outstanding Series E convertible preferred stock voting as a separate series (a) change the rights, preferences, or privileges of the Series E convertible preferred stock or (b) authorize or issue more than 8,260,000 shares of Series E convertible preferred stock, (ii) at least 60% of the then outstanding shares of Series D convertible preferred stock voting as a separate series, change the rights, preferences, or privileges of the Series D convertible preferred stock, (iii) at least 60% of the then outstanding shares of Series C convertible preferred stock voting as a separate series, change the rights, preferences, or privileges of the Series C convertible preferred stock, and (iv) at least a majority of the then outstanding shares of Series B convertible preferred stock voting as a separate series, change the rights, preferences, or privileges of the Series B convertible preferred stock.

The rights of each series of our preferred stock, including those describe above, will terminate upon the conversion of all outstanding shares of convertible preferred stock immediately prior to the closing of this offering.

Convertible Debt Facility

In June 2011, we entered into a junior secured convertible loan facility, or Convertible Facility, with certain existing preferred stockholders that provided for up to \$50.0 million in borrowings, of which we borrowed \$12.5 million in an initial advance upon signing. In November 2011, we amended the Convertible Facility to provide for an aggregate of up to \$80.0 million in borrowings. In March 2012, we further amended the Convertible Facility to provide for the automatic conversion of the principal amount and paid-in-kind interest under the Convertible Facility into common stock upon closing of this offering at a conversion price equal to the lesser of \$8.8984 or the initial public offering price. We borrowed \$7.5 million in a second advance in November 2011 and may borrow up to an additional \$60.0 million prior to the earlier of (i) a subsequent equity financing of more than \$10.0 million or (ii) June 14, 2013, subject to the attainment of certain financial and operating conditions. The Convertible Facility bears an interest rate of 9.0%, with interest payable in kind at maturity, which is the earlier to occur of the closing of (i) our initial public offering, (ii) a change in control or (iii) June 14, 2014. The

[Table of Contents](#)

initial and second advances of \$12.5 million and \$7.5 million, respectively, together with accrued interest, are convertible into common stock at a conversion price equal to the lesser of \$8.8984 or the initial public offering price. Additional borrowings and accrued interest are repayable at the holders' option as follows: up to 50% convertible into common stock at a price equal to the lesser of \$8.8984 or the initial public offering price, and the remainder in cash. In addition, we may prepay, at our election, up to 50% of any additional borrowings and related accrued interest at any time. The Convertible Facility is secured by substantially all of our assets except intellectual property and contains certain required covenants.

In consideration for the lenders' commitment under this facility, we issued an aggregate of 352,665 shares of common stock at a purchase price of \$5.27 per share to fourteen of the lenders and issued to the remaining lenders warrants to purchase up to an aggregate amount of 131,516 shares of our common stock for an exercise price of \$5.27 per share. The warrants are immediately exercisable. Warrants to purchase 76,601 shares of our common stock will expire on June 14, 2016, and warrants to purchase 54,915 shares of our common stock will expire on November 16, 2016, subject to earlier termination upon an acquisition of us in which the consideration payable to holders of our common stock consists of cash and/or a class of securities that are registered under the Securities Exchange Act of 1934, as amended.

The following table summarizes the initial amounts invested, as well as the aggregate commitment amounts, of one of our directors and of holders of more than 5% of our capital stock and their affiliated entities with respect to the Convertible Facility.

<u>Name</u>	<u>Amount of Initial Note Investment</u>	<u>Amount of Second Note Investment</u>	<u>Aggregate Commitment Amount</u>	<u>Number of Common Shares Purchased</u>	<u>Number of Common Shares Underlying Warrant Issued</u>
Applied Ventures, LLC	\$ 610,525	\$ 394,362	\$ 4,019,548	—	24,394
Funds affiliated with Third Point LLC ⁽¹⁾	1,986,035	1,282,858	13,075,570	—	79,353
Madrone Partners, L.P. ⁽²⁾	1,536,451	992,454	10,115,618	61,391	—
Funds affiliated with Bay Partners ⁽³⁾	569,522	504,199	4,294,823	26,378	—
KPCB Holdings, Inc., as nominee ⁽⁴⁾	6,250,000	3,750,000	40,000,000	242,100	—
Robert Schwartz ⁽⁵⁾	12,500	—	50,000	—	284

- (1) Includes initial and second note investments of \$1,339,323.45 and \$865,121.51, respectively, by Third Point Offshore Master Fund L.P., \$173,535.27 and \$112,093.23, respectively, by Third Point Partners L.P., \$287,197.55 and \$185,512.15, respectively, by Third Point Partners Qualified L.P. and \$185,978.55 and \$120,130.83, respectively, by Third Point Ultra Master Fund L.P. Also includes warrants to purchase 53,515 shares of Common Stock issued to Third Point Offshore Master Fund L.P., 6,933 shares of Common Stock issued to Third Point Partners L.P., 11,475 shares of Common Stock issued to Third Point Partners Qualified L.P. and 7,430 shares of Common Stock issued to Third Point Ultra Master Fund L.P. Robert Schwartz, one of our directors, is Managing Partner of Third Point Ventures, but does not have any voting or dispositive power with respect to the shares of stock held by the funds affiliated with Third Point Ventures.
- (2) Jameson J. McJunkin is one of our directors and is a Managing Member of Madrone Capital Partners. Mr. McJunkin disclaims beneficial ownership of such securities except to the extent of his pecuniary interest therein.
- (3) Includes initial and second note investments of \$566,674.05 and \$501,677.29, respectively, by Bay Partners XI, L.P. and \$2,848.00 and \$2,521.33, respectively, by Bay Partners XI Parallel Fund, L.P. Also includes 26,248 shares of Common Stock purchased by Bay Partners XI, L.P. and 130 shares of Common Stock purchased by Bay Partners XI Parallel Fund, L.P. Neal Dempsey is one of our directors and is a Managing Member with Bay Partners. Mr. Dempsey disclaims beneficial ownership of such securities except to the extent of his pecuniary interest therein.
- (4) KPCB Holdings, Inc. serves as agent to the lenders with respect to the Convertible Facility. Includes initial and second note investments of \$5,958,125.00 and \$3,574,875.00, respectively, by KPCB Green Growth Fund, LLC, \$4,087.50 and \$2,452.50, respectively, by Benjamin Kortlang and \$287,787.50 and \$172,672.50, respectively, by individuals and entities affiliated with KPCB Green Growth Fund, LLC. Also includes 230,795 shares of Common Stock issued to KPCB Green

[Table of Contents](#)

Growth Fund, LLC, 158 shares of Common Stock issued to Benjamin Kortlang and 11,147 shares of Common Stock issued to individuals and entities affiliated with KPCB Green Growth Fund, LLC. The managing member for KPCB Green Growth Fund, LLC is KPCB GGF Associates, LLC. Benjamin Kortlang is one of our directors and is a member of the KPCB Green Growth Associates, LLC. The securities held by KPCB Green Growth Fund, LLC, Benjamin Kortlang and affiliated individuals and entities are held for convenience in the name of "KPCB Holdings, Inc. as nominee," for the accounts of the individual managers, Benjamin Kortlang and other individuals and entities that each exercise their own voting and dispositive control over the securities for their own accounts. KPCB Holdings, Inc. has no voting, dispositive or pecuniary interest in any such securities.

- (5) Robert Schwartz, a member of our board of directors, is a Managing Partner of Third Point Ventures.

Loan to Officer

In connection with the hiring of Sanjeev Kumar, our Chief Financial Officer, we extended a loan to him in the principal amount of \$50,000, with an interest rate of 0.74% per annum, as an advance on his first-year performance bonus, which was evidenced by a full-recourse promissory note dated June 14, 2010. In November 2010, in light of Mr. Kumar's 2010 performance, including his substantial progress toward achieving his 2010 performance goals and the substantial progress made in improving our financial systems and controls, the outstanding principal and accrued interest under the loan was forgiven and the note was cancelled.

Investors' Rights Agreement

In connection with our preferred stock financings, we entered into an investors' rights agreement with certain purchasers of our preferred stock, including the following principal stockholders, directors and executive officers:

Funds affiliated with Third Point LLC
RockPort Capital Partners II, L.P.
Madrone Partners, L.P.
KPCB Holdings, Inc., as nominee
Applied Ventures, LLC

Funds affiliated with Bay Partners
Paul B. Nahi
Raghuveer R. Belur
Martin Fornage
Robert Schwartz

Pursuant to this agreement, we granted such stockholders certain registration rights with respect to certain shares of our common stock held or issuable upon conversion of the shares of preferred stock held by them. For a description of these registration rights, see "Description of Capital Stock—Registration Rights." In addition to the registration rights, the investors' rights agreement provides for certain rights to receive financial information and rights of first refusal to participate in subsequent equity financings. The provisions and covenants contained in the investors' rights agreement, including with respect to information rights, rights of first refusal and various other affirmative covenants by the company, and other than those relating to registration rights and general contract provisions, will terminate upon the completion of this offering.

Voting Agreement

Pursuant to our 2010 voting agreement that we entered into with certain holders of our common stock and certain holders of our preferred stock:

- KPCB Holdings, Inc., as nominee, has the right to designate a director to our board of directors, which is currently Mr. Kortlang;
- funds affiliated with Bay Partners have the right to designate a director to our board of directors, which is currently Mr. Dempsey;
- funds affiliated with Madrone Capital Partners have the right to designate a director to our board of directors, which is currently Mr. McJunkin;
- funds affiliated with RockPort Capital Partners have the right to designate a director to our board of directors, which is currently Mr. Wilson;

[Table of Contents](#)

- funds affiliated with Third Point LLC have the right to designate a director to our board of directors, which is currently Mr. Schwartz;
- Messrs. Nahi, Belur and Fornage have the right to designate, by a majority of the voting shares of common stock then held by them, two members of our board of directors, one of which shall be our then-current Chief Executive Officer, currently Mr. Nahi, and one of which is currently Mr. Belur; and
- the then-serving members of our board of directors have the right to nominate, by unanimous agreement, one director to our board of directors, which directorship is currently held by Mr. Gomo.

This voting agreement will terminate upon the completion of this offering and there will be no further contractual arrangements regarding the election of our directors.

Participation in this Offering

Entities affiliated with Third Point, Madrone, KPCB and Bay Partners, each of which is an existing holder of more than 5% of our capital stock and each is affiliated with a member of our board of directors, have indicated an interest in purchasing up to an aggregate of \$15.0 million of shares of our common stock in this offering at the price offered to the public. Because these indications of interest are not binding agreements or commitments to purchase, these stockholders may elect not to purchase shares in this offering or the underwriters may elect not to sell any shares in this offering to such stockholders.

Indemnification of Officers and Directors

Our amended and restated certificate of incorporation and bylaws provide that we shall indemnify each of our directors and officers to the fullest extent permitted by the Delaware General Corporation Law. Further, we have entered into indemnification agreements with each of our directors and officers. For further information, see the section entitled “Executive Compensation—Indemnification of Directors and Officers and Limitation of Liability.”

Transactions with Affiliate Controlled Companies

In December 2011, we entered into sales transactions with two PV systems development companies that are majority-owned by KPCB Holdings, Inc., as nominee, and of which Benjamin Kortlang, a member of our board of directors, is a member of the board of directors. Pursuant to these transactions, these companies and one of their managed project finance funds agreed to purchase our microinverters through our distributors at the same price that our distributors generally charge their customers. Prior to December 31, 2011, we received \$20.3 million in cash from these customers and recognized revenues of \$6.4 million from such transactions in the fourth quarter of 2011. The remaining \$13.9 million was recorded as deferred revenues in the consolidated balance sheet as of December 31, 2011, with product delivery and revenue recognition expected to be in the first half of 2012.

Policies and Procedures for Related Party Transactions

We believe that we have executed all of the transactions set forth above on terms no less favorable to us than we could have obtained from unaffiliated third parties. It is our intention to ensure that all future transactions between us and our officers, directors and principal stockholders and their affiliates, are approved by the audit committee of our board of directors, and are on terms no less favorable to us than those that we could obtain from unaffiliated third parties.

Following this offering, all future related party transactions will be reviewed and approved by our audit committee. Pursuant to our written code of business conduct and ethics, the audit committee is responsible for approving, prior to our entry into any transaction involving related parties, all transactions in which we are a participant and in which any parties related to us has or will have a direct or indirect material interest.

[Table of Contents](#)

In reviewing and approving these transactions, our audit committee will obtain, or will direct our management to obtain on its behalf, all information that the committee believes to be relevant and important to a review of the transaction prior to its approval. Following receipt of the necessary information, a discussion will be held of the relevant factors, if deemed to be necessary by the committee, prior to approval. If a discussion is not deemed to be necessary, approval may be given by written consent of the committee. No related party transaction will be entered into prior to the completion of these procedures.

Our audit committee will approve only those related party transactions that are determined to be in, or not inconsistent with, our best interests and those of our stockholders, taking into account all available facts and circumstances as the committee or the chairman determines in good faith to be necessary. No member of our audit committee will participate in any review, consideration or approval of any related party transaction with respect to which the member or any of his or her immediate family members is the related party.

Promoters

Raghuveer R. Belur and Martin Fornage, our co-founders and original stockholders, are deemed to be our “promoters” as these terms are defined under the federal securities laws. Messrs. Belur and Fornage have not received, and are not expected to receive, any compensation or consideration in their capacity as promoters.

PRINCIPAL STOCKHOLDERS

The following table sets forth information regarding beneficial ownership of our common stock as of March 1, 2012 by:

- each person or group of affiliated persons known by us to be the beneficial owner of more than 5% of our common stock;
- each of our named executive officers;
- each of our directors; and
- all executive officers and directors as a group.

The percentage ownership information shown in the table below is based upon 30,142,821 shares of common stock outstanding as of March 1, 2012, assuming (1) the conversion of all outstanding preferred stock into 25,170,918 shares of our common stock and (2) the automatic conversion of the outstanding principal amount of our junior secured convertible loan facility and paid-in-kind interest into 3,262,118 shares of common stock upon closing of this offering at a conversion price equal to \$6.50, the midpoint of the price range set forth on the cover page of this prospectus, on April 4, 2012. The percentage ownership information indicated in the following table reflects the sale by us of 7,272,727 shares of common stock in this offering.

The actual numbers of shares that will be issued upon conversion of our junior secured convertible loan facility is based on the assumptions set forth above and will likely differ from the numbers appearing in this discussion and the following table and footnotes. See “Prospectus Summary—The Offering.”

Information with respect to beneficial ownership has been furnished by each director, officer or beneficial owner of more than 5% of our common stock. We have determined beneficial ownership in accordance with the rules of the SEC. These rules generally attribute beneficial ownership of shares to persons who possess sole or shared voting or investment power with respect to such shares. The information does not necessarily indicate beneficial ownership for any other purpose. Under these rules, the number of shares of common stock deemed outstanding includes shares issuable upon exercise of options, warrants or other convertible securities held by the respective person or group which may be exercised or converted within 60 days after March 1, 2012. These shares are deemed to be outstanding and beneficially owned by the person holding those options for the purpose of computing the percentage ownership of that person or entity, but they are not treated as outstanding for the purpose of computing the percentage ownership of any other person or entity. Unless otherwise indicated and subject to applicable community property laws, to our knowledge, each stockholder named in the following table possesses sole voting and investment power over the shares listed, except for those jointly owned with that person’s spouse. Unless otherwise indicated below, the address of each person listed on the table is c/o Enphase Energy, Inc., 201 1st Street, Suite 100, Petaluma, California 94952, USA.

Table of Contents

Name and Address of Beneficial Owner 5% Stockholders:	Number of Shares Beneficially Owned		Percentage of Common Stock Beneficially Owned	
	Prior to Offering	After Offering	Prior to Offering	After Offering
Funds affiliated with Third Point LLC ⁽¹⁾⁽²¹⁾	5,609,995	5,609,995	18.2%	14.8%
RockPort Capital Partners II, L.P. ⁽²⁾⁽²¹⁾	4,717,239	4,717,239	15.6	12.6
Madrone Partners, L.P. ⁽³⁾⁽²¹⁾	4,340,047	4,340,047	14.2	11.5
KPCB Holdings, Inc., as nominee ⁽⁴⁾⁽²¹⁾	3,897,667	3,897,667	12.3	10.0
Applied Ventures, LLC ⁽⁵⁾	1,823,782	1,823,782	6.0	4.9
Funds affiliated with Bay Partners ⁽⁶⁾⁽²¹⁾	1,641,284	1,641,284	5.4	4.4
Named executive officers and directors:				
Paul B. Nahi ⁽⁷⁾	1,166,674	1,166,674	3.8	3.0
Sanjeev Kumar ⁽⁸⁾	168,734	168,734	*	*
Jeff Loebbaka ⁽⁹⁾	117,004	117,004	*	*
Dennis Hollenbeck ⁽¹⁰⁾	70,541	70,541	*	*
Greg Steele ⁽¹¹⁾	159,863	159,863	*	*
Raghuvveer R. Belur ⁽¹²⁾	1,001,926	1,001,926	3.3	2.6
Neal Dempsey ⁽¹³⁾	1,641,284	1,641,284	5.4	4.4
Steven J. Gomo ⁽¹⁴⁾	8,948	8,948	*	*
Benjamin Kortlang ⁽¹⁵⁾	3,897,667	3,897,667	12.3	10.0
Jameson J. McJunkin ⁽¹⁶⁾	4,340,047	4,340,047	14.2	11.5
Chong Sup Park ⁽¹⁷⁾	6,883	6,883	*	*
Robert Schwartz ⁽¹⁸⁾	51,582	51,582	*	*
Stoddard M. Wilson ⁽¹⁹⁾	4,717,239	4,717,239	15.6	12.6
All executive officers and directors as a group (15 persons) ⁽²⁰⁾⁽²¹⁾	18,687,118	18,687,118	53.1	44.0

- * Represents less than 1%
- (1) Consists of: (a)(i) 3,370,382 shares, (ii) 359,325 shares issuable upon the conversion of principal and interest outstanding under a convertible promissory note as of April 4, 2012, and (iii) warrants exercisable for 53,515 shares within 60 days of March 1, 2012, held by Third Point Offshore Master Fund L.P.; (b)(i) 436,696 shares, (ii) 46,556 shares issuable upon the conversion of principal and interest outstanding under a convertible promissory note as of April 4, 2012, and (iii) warrants exercisable for 6,933 shares within 60 days of March 1, 2012, held by Third Point Partners L.P.; (c)(i) 722,727 shares, (ii) 77,052 shares issuable upon the conversion of principal and interest outstanding under a convertible promissory note as of April 4, 2012, and (iii) warrants exercisable for 11,475 shares within 60 days of March 1, 2012, held by Third Point Partners Qualified L.P.; and (d)(i) 468,009 shares, (ii) 49,895 shares issuable upon the conversion of principal and interest outstanding under a convertible promissory note as of April 4, 2012, and (iii) warrants exercisable for 7,430 shares within 60 days of March 1, 2012, held by Third Point Ultra Master Fund L.P. Mr. Schwartz, a member of our board of directors, is a Managing Partner of Third Point Ventures, but does not have any voting or dispositive power with respect to the shares held by Third Point Ventures and its affiliated entities. Mr. Schwartz disclaims beneficial ownership of these shares except to the extent of his pecuniary interest therein. Third Point LLC, and Daniel S. Loeb in his capacity as the Chief Executive Officer of Third Point LLC, have voting and dispositive power over shares held by Third Point Offshore Master Fund L.P., Third Point Partners L.P., Third Point Partners Qualified L.P. and Third Point Ultra Master Fund L.P. Mr. Loeb disclaims beneficial ownership of these shares except to the extent of his pecuniary interest therein. The address of Third Point Partners is 390 Park Avenue, 18th Floor, New York, NY 10022.
- (2) Voting and dispositive powers are shared by the Managing Members of the General Partner of RockPort Capital Partners II, L.P. Its Managing Members are William James, David Prend, Alexander Ellis, III, Charles McDermott, Janet James and Stoddard Wilson, a member of our board of directors. Messrs. James, Prend, Ellis, McDermott and Wilson, and Ms. James, disclaim beneficial ownership of these shares except to the extent of their pecuniary interest therein. The address of Rockport Capital Partners is 160 Federal Street, 18th Floor, Boston, MA 02110-1700.
- (3) Includes 412,212 shares issuable upon the conversion of principal and interest outstanding under a convertible promissory note as of April 4, 2012. Greg Penner, Thomas Patterson and Jameson McJunkin, a member of our board of directors, share voting and dispositive power over shares held by Madrone Capital Partners; however, Messrs. Penner, Patterson and McJunkin disclaim beneficial ownership of these shares except to the extent of their pecuniary interest therein. The address of Madrone Partners is 3000 Sand Hill Road, Building 1, Suite 150, Menlo Park, CA 94025.

Table of Contents

- (4) Consists of: (a)(i) 2,160,738 shares and (ii) 1,554,908 shares issuable upon the conversion of principal and interest outstanding under a convertible promissory note as of April 4, 2012, held by KPCB Green Growth Fund, LLC; (b)(i) 1,482 shares and (ii) 1,067 shares issuable upon the conversion of principal and interest outstanding under a convertible promissory note as of April 4, 2012, held by Benjamin Kortlang, a member of our board of directors; and (c)(i) 104,367 shares and (ii) 75,105 shares issuable upon the conversion of principal and interest outstanding under a convertible promissory note as of April 4, 2012, in the aggregate beneficially owned by individuals and entities affiliated with KPCB Green Growth Fund, LLC. The managing member for KPCB Green Growth Fund, LLC is KPCB GGF Associates, LLC. Brook H. Byers, L. John Doerr, Joseph Lacob, Raymond J. Lane and Theodore E. Schlein, the Managing Directors of KPCB GGF Associates, LLC, and Ben Kortlang, a member of KPCB GGF Associates, LLC, exercise shared voting and dispositive control over the shares directly held by KPCB Green Growth Fund, LLC. The shares held by KPCB Green Growth Fund, LLC, Benjamin Kortlang and affiliated individuals and entities are held for convenience in the name of "KPCB Holdings, Inc. as nominee," for the accounts of the individual managers, Benjamin Kortlang and other individuals and entities that each exercise their own voting and dispositive control over the shares for their own accounts. KPCB Holdings, Inc. has no voting, dispositive or pecuniary interest in any such shares. The address of KPCB Green Growth Fund, LLC is 2750 Sand Hill Road, Menlo Park, CA 94025.
- (5) Includes: (a) 163,796 shares issuable upon the conversion of principal and interest outstanding under a convertible promissory note as of April 4, 2012, and (b) warrants exercisable for 24,394 shares within 60 days of March 1, 2012. J. Christopher Moran, in his capacity as General Manager of Applied Ventures, LLC, has sole voting and dispositive power over shares held by Applied Ventures, LLC. J. Christopher Moran, Dr. Omkaran Nalamasu, Dr. Mark R. Pinto and Larry Sparks, in their capacity as members of the Venture Investment Committee of Applied Materials, Inc., have shared voting and dispositive power over shares held by Applied Ventures, LLC; however, Messrs. Moran and Sparks, and Drs. Nalamasu and Pinto disclaim beneficial ownership of these shares. The address of Applied Ventures, LLC is 3050 Bowers Avenue, Santa Clara, CA 95054.
- (6) Consists of: (a)(i) 7,331 shares and (ii) 872 shares issuable upon the conversion of principal and interest outstanding under a convertible promissory note as of April 4, 2012, held by Bay Partners XI Parallel Fund, L.P.; and (b)(i) 1,459,447 shares and (ii) 173,634 shares issuable upon the conversion of principal and interest outstanding under a convertible promissory note as of April 4, 2012, held by Bay Partners XI, L.P. Stuart G. Phillips and Neal Dempsey, a member of our board of directors, are Managers of Bay Management Company XI, LLC and share voting and dispositive power over shares held by Bay Partners XI Parallel Fund, L.P. and Bay Partners XI, L.P. Messrs. Phillips and Dempsey disclaim beneficial ownership of these shares except to the extent of their pecuniary interest therein. The address of Bay Partners is 490 South California Avenue, Suite 200, Palo Alto, CA 94306.
- (7) Includes: (a) 27,533 shares of common stock held by Paul B. Nahi and Sheila B. Nahi, as Trustees of the Skylar Lisle Nahi Trust u/a/d December 21, 2009; (b) 27,533 shares of common stock held by Paul B. Nahi and Sheila B. Nahi, as Trustees of the Skylar Lisle Nahi Trust u/a/d December 21, 2009; and (c) stock options for 951,393 shares of our common stock exercisable within 60 days of March 1, 2012.
- (8) Consists solely of stock options to purchase 168,734 shares of our common stock exercisable within 60 days of March 1, 2012.
- (9) Consists solely of stock options to purchase 117,004 shares of our common stock exercisable within 60 days of March 1, 2012.
- (10) Consists solely of stock options to purchase 70,541 shares of our common stock exercisable within 60 days of March 1, 2012.
- (11) Includes stock options to purchase 99,731 shares of our common stock exercisable within 60 days of March 1, 2012.
- (12) Includes (a) 275,330 shares held by The Raghuvver Belur Grantor Retained Annuity Trust; and (b) stock options to purchase 619,655 shares of our common stock within 60 days of March 1, 2012.
- (13) Consists solely of the shares described in Note (6) above. Mr. Dempsey disclaims beneficial ownership of these shares, except to the extent of his pecuniary interest therein.
- (14) Consists solely of stock options to purchase 8,948 shares of our common stock exercisable within 60 days of March 1, 2012.
- (15) Consists solely of the shares described in Note (4) above. Mr. Kortlang disclaims beneficial ownership of these shares, except to the extent of his pecuniary interest therein.
- (16) Consists solely of the shares described in Note (3) above. Mr. McJunkin disclaims beneficial ownership of these shares, except to the extent of his pecuniary interest therein.
- (17) Consists solely of stock options to purchase 6,883 shares of our common stock exercisable within 60 days of March 1, 2012.
- (18) Includes: (a) 2,067 shares issuable upon the conversion of principal and interest outstanding under a convertible promissory note as of April 4, 2012 and (b) warrants to purchase 284 shares within 60 days of March 1, 2012. Excludes the shares described in Note (1) above, which Mr. Schwartz disclaims beneficial ownership of, except to the extent of his pecuniary interest therein.

Table of Contents

- (19) Consists solely of the shares described in Note (2) above. Mr. Wilson disclaims beneficial ownership of these shares, except to the extent of his pecuniary interest therein.
- (20) Includes: (a) 12,427,671 shares; (b) 2,219,864 shares issuable upon the conversion of principal and interest outstanding under convertible promissory notes as of April 4, 2012; (c) warrants exercisable for 284 shares within 60 days of March 1, 2012, held by one of our directors and entities affiliated with certain of our directors; and (d) 4,023,468 shares beneficially owned by our executive officers, of which stock options for 2,802,741 shares of common stock are exercisable within 60 days of March 1, 2012.
- (21) Entities affiliated with Third Point LLC, Madrone Partners, L.P., KPCB Holdings, Inc., as nominee and Bay Partners, which we refer to collectively as the Current Stockholders, have indicated an interest in purchasing up to an aggregate of \$15.0 million of shares of our common stock in this offering at the price offered to the public, or an aggregate of 2,307,692 shares based on an initial public offering price of \$6.50 per share, the midpoint of the price range set forth on the cover page of this prospectus. If the Current Stockholders purchase all of these shares, the number of shares beneficially owned by each Current Stockholder after this offering, and the percentage of our common stock beneficially owned by each Current Stockholder after this offering, will increase. In addition, if the Current Stockholders purchase all of these shares, the number of shares beneficially owned by all of our executive officers, directors and stockholders who beneficially own more than 5% of our outstanding common stock after this offering will increase from 26,120,895 to 28,428,587, and the percentage of common stock beneficially owned by this group after this offering will increase from approximately 63.7% to approximately 69.2%.

DESCRIPTION OF CAPITAL STOCK

Upon consummation of this offering, our authorized capital stock will consist of 100,000,000 shares of common stock, \$0.0001 par value per share, and 10,000,000 shares of preferred stock, \$0.0001 par value per share. A description of the material terms and provisions of our amended and restated certificate of incorporation and amended and restated bylaws affecting the rights of holders of our capital stock is set forth below. The description is intended as a summary, and is qualified in its entirety by reference to the form of our amended and restated certificate of incorporation and the form of our amended and restated bylaws to be effective upon the completion of this offering and filed with the registration statement of which this prospectus is a part.

As of December 31, 2011, and after giving effect to (1) the automatic conversion of all outstanding shares of our preferred stock into 25,170,918 shares of our common stock and (2) the automatic conversion of the outstanding principal amount of our junior secured convertible loan facility and paid-in-kind interest as of December 31, 2011 into shares of common stock upon closing of this offering at a conversion price equal to \$6.50, the midpoint of the price range set forth on the cover page of this prospectus, there were outstanding:

- 30,055,620 shares of common stock held by 118 stockholders;
- 6,255,867 shares of common stock issuable upon exercise of outstanding stock options; and
- 357,459 shares of common stock issuable upon exercise of outstanding warrants, assuming the automatic conversion of outstanding warrants to purchase shares of our convertible preferred stock into warrants to purchase our common stock immediately prior to the completion of this offering.

Because the number of shares that will be issued upon conversion of our junior secured convertible loan facility depends upon the actual initial public offering price per share in this offering and the closing date of this offering, the actual number of shares issuable upon such conversion may differ from the number of shares set forth above. See “Prospectus Summary – The Offering.”

Common Stock

Dividend Rights. Subject to preferences that may apply to shares of preferred stock outstanding at the time, the holders of outstanding shares of our common stock are entitled to receive dividends out of funds legally available if our board of directors, in its discretion, determines to issue dividends and then only at the times and in the amounts that our board of directors may determine.

Voting Rights. Each holder of common stock is entitled to one vote for each share of common stock held on all matters submitted to a vote of stockholders. Our certificate of incorporation does not provide for the right of stockholders to cumulate votes for the election of directors. Our certificate of incorporation effective upon completion of this offering establishes a classified board of directors, to be divided into three classes with staggered three-year terms. Only one class of directors will be elected at each annual meeting of our stockholders, with the other classes continuing for the remainder of their respective three-year terms. These provisions in our amended and restated certificate of incorporation could discourage potential takeover attempts. See “Risk Factors—Our charter documents and Delaware law could prevent a takeover that stockholders consider favorable and could also reduce the market price of our stock.”

No Preemptive or Similar Rights. Our common stock is not entitled to preemptive rights and is not subject to conversion, redemption or sinking fund provisions. The rights, preferences and privileges of the holders of our common stock are subject to, and may be adversely affected by, the rights of the holders of any series of our preferred stock that we may designate and issue in the future.

[Table of Contents](#)

Right to Receive Liquidation Distributions. Upon our dissolution, liquidation or winding-up, the assets legally available for distribution to our stockholders are distributable ratably among the holders of our common stock, subject to prior satisfaction of all outstanding debt and liabilities and the preferential rights and payment of liquidation preferences, if any, on any outstanding shares of preferred stock.

Fully Paid and Nonassessable. All of our outstanding shares of common stock are, and the shares of common stock to be issued in this offering will be, fully paid and nonassessable.

Preferred Stock

Upon the completion of this offering, each outstanding share of preferred stock will be converted into common stock.

Each share of Series E, D, C, B and A convertible preferred stock is convertible at the option of the holder into the number of shares of common stock which results from dividing the original issue price for such series of convertible preferred stock by the conversion price for such series of convertible preferred stock, subject to certain adjustments, as set forth below:

	<u>Original Issue Price</u>	<u>Conversion Price</u>	<u>Shares of Common Stock</u>
Series E	\$ 6.174	\$ 6.174	1
Series D	2.134	2.134	1
Series C	11.665	4.640	2.514
Series B	6.015	3.169	1.898
Series A	2.906	2.370	1.226

The Series E, D, C, B and A convertible preferred stock will be automatically converted into common stock: (a) immediately prior to the closing of a firmly underwritten public offering pursuant to the Securities Act if aggregate gross proceeds to the company in such offering equal or exceed \$30,000,000 and the public offering price is not less than \$6.174 per share, or a "Qualified Public Offering"; and (b) upon our receipt of the written consent of the holders of (i) 60% of the Series E convertible preferred stock voting as a separate series, with respect to the conversion of all outstanding shares of Series E convertible preferred stock, (ii) a majority of the Series E convertible preferred stock voting as a separate series in connection with an initial public offering that is not a Qualified Public Offering, or (iii) a majority of the holders of the Series A, B, C and D convertible preferred stock voting together on an as-converted basis with respect to the conversion of all outstanding shares of Series A, B, C and D convertible preferred stock.

Following this offering, we will be authorized, subject to limitations prescribed by Delaware law, to issue preferred stock in one or more series, to establish from time to time the number of shares to be included in each series and to fix the designation, powers, preferences and rights of the shares of each series and any of its qualifications, limitations or restrictions. Our board of directors can also increase or decrease the number of shares of any series, but not below the number of shares of that series then outstanding, without any further vote or action by our stockholders. Our board of directors may authorize the issuance of preferred stock with voting or conversion rights that could adversely affect the voting power or other rights of the holders of the common stock. The issuance of preferred stock, while providing flexibility in connection with possible acquisitions and other corporate purposes, could, among other things, have the effect of delaying, deferring, discouraging or preventing a change in control of our company and may adversely affect the market price of our common stock and the voting and other rights of the holders of common stock. We have no current plan to issue any shares of preferred stock.

Warrants

As of December 31, 2011, 11,013 shares of our common stock were issuable upon exercise of an outstanding warrant to purchase common stock with an exercise price of \$4.54 per share. This warrant was issued in connection with the execution of a supply and services agreement we entered into with a potential customer. This warrant was subject vesting conditions and would have fully vested if certain product purchasing milestones had been satisfied by the customer before March 4, 2012. However, such conditions were not satisfied prior to the required date, and therefore this warrant terminated on March 4, 2012.

As of December 31, 2011, 11,013 shares of our Series C preferred stock were issuable upon exercise of an outstanding warrant to purchase Series C preferred stock with an exercise price of \$11.665 per share. This warrant was issued in connection with the execution of a strategic collaboration agreement we entered into with a potential distributor. This warrant becomes exercisable upon the completion of certain product qualification and certification milestones, and will expire upon the earlier of (i) a change in control of Enphase, (ii) six months after becoming exercisable, or (iii) immediately prior to the closing of this offering. The warrant contains provisions for the adjustment of the exercise price and the number of shares issuable upon the exercise of the warrant in the event of stock dividends, stock splits, reorganizations and reclassifications. We do not expect that the exercise milestones will be met prior to the closing of this offering, and therefore we expect this warrant will expire.

As of December 31, 2011, an aggregate of 161,958 shares of our Series E preferred stock were issuable upon exercise of two outstanding warrants to purchase Series E preferred stock, each with an exercise price of \$6.174 per share. These warrants were issued in connection with the execution of certain credit facilities we entered into with three lenders. These warrants are immediately exercisable and will expire upon the later of (i) ten years after the issuance date of each respective warrant, or (ii) five years after the closing of this offering. These warrants have a net exercise provision under which the holder may, in lieu of payment of the exercise price in cash, surrender the warrants and receive a net amount of shares based on the fair market value of our common stock at the time of exercise of the warrants after deduction of the aggregate exercise price. The warrants contain provisions for the adjustment of the exercise price and the number of shares issuable upon the exercise of the warrants in the event of stock dividends, stock splits, reorganizations and reclassifications and consolidations. Following the closing of this offering, these warrants will be exercisable for an aggregate of 161,958 shares of our common stock.

As of December 31, 2011, an aggregate of 25,285 shares of our Series E preferred stock were issuable upon exercise of an outstanding warrant to purchase Series E preferred stock, with an exercise price of \$8.8984 per share. These warrants were issued in connection with the execution of an equipment financing facility. These warrants are immediately exercisable and will expire upon the later of (i) ten years after the issuance date of each respective warrant, or (ii) five years after the closing of this offering. The warrants contain provisions for the adjustment of the exercise price and the number of shares issuable upon the exercise of the warrants in the event of stock dividends, stock splits, reorganizations and reclassifications and consolidations. Following the closing of this offering, these warrants will be exercisable for an aggregate of 25,285 shares of our common stock.

As of December 31, 2011, an aggregate of 76,601 shares of our common stock were issuable upon exercise of outstanding warrants to purchase common stock with an exercise price of \$5.27 per share. These warrants were issued to certain existing preferred stockholders in connection with our junior secured convertible loan facility. The warrants are immediately exercisable and will expire on June 14, 2016, subject to earlier termination upon an acquisition of Enphase in which the consideration payable to holders of our common stock consists of cash and/or a class of securities that are registered under the Securities Exchange Act of 1934, as amended. The warrants contain provisions for the adjustment of the exercise price and/or the number of shares issuable upon the exercise of the warrants in the event of stock dividends, stock splits, stock combinations, reorganizations, reclassifications, exchanges, substitutions and consolidations. In connection with the November 2011 amendment to our junior secured convertible loan facility, we issued warrants to purchase an additional 54,915 shares of our common stock, with an exercise price of \$5.27 per share, to certain existing preferred stockholders. See Notes 7 and 10 to Consolidated Financial Statements.

Registration Rights

Following the closing of this offering, certain holders of our common stock, or their transferees, will be entitled to the registration rights set forth below with respect to registration of the resale of such shares under the Securities Act pursuant to an investors' rights agreement by and among us and certain of our stockholders.

Demand registration rights. Following the closing of this offering, the holders of approximately 29,747,889 shares of our common stock will be entitled to certain demand registration rights. At any time after six months following completion of this offering, the holders of at least a majority of these shares have the right to request that we file up to two registration statements. We may postpone the filing of a registration statement for up to 90 days if we determine that the filing would be seriously detrimental to us and our stockholders, and the underwriters of an underwritten offering will have the right, subject to certain restrictions, to limit the number of shares registered by these holders for reasons relating to the marketing of the shares.

Piggyback registration rights. Following the closing of this offering, if we propose to register any of our securities for public sale, the holders of approximately 29,747,889 shares of our common stock will be entitled to certain "piggyback" registration rights allowing the holders to include their shares in such registration. However, this right does not apply to a registration relating to any of our employee benefit plans, the exchange of securities in certain corporate reorganizations or certain other transactions or the issuance of common stock upon conversion of debt securities, the offer and sale of which are also being registered. The underwriters of any underwritten offering will have the right to limit the number of shares registered by these holders for reasons relating to the marketing of the shares, but not below 30% of the total number of shares included in the registration statement.

Form S-3 registration rights. Following the closing of this offering, the holders of approximately 29,747,889 shares of our common stock will be entitled to certain Form S-3 registration rights. At any time after we are eligible to file a registration statement on Form S-3, holders of at least 25% of these shares have the right to request that we effect a registration on Form S-3 if the proposed aggregate offering price of the shares to be registered by the holders requesting registration is at least \$1,000,000. We will not be required to effect such a registration if we have effected one such registration within the 24-month period preceding a request and we may postpone the filing of a registration statement on Form S-3 for up to 90 days if we determine that the filing would be seriously detrimental to us and our stockholders. The underwriters of any underwritten offering will have the right, subject to certain restrictions, to limit the number of shares registered by these holders for reasons relating to the marketing of the shares.

Registration expenses. We will pay all expenses incurred by holders of shares registered in connection with up to two demand registrations and all piggyback and Form S-3 registrations except, in each case, for fees and expenses of legal counsel in excess of \$50,000, underwriting discounts, selling commissions and transfer taxes. However, subject to limited exceptions, we will not pay for any expenses of any demand registration if the request is subsequently withdrawn by the holders or if the net proceeds requirement of a demand registration is not met.

Expiration of registration rights. The registration rights described above will expire five years after the closing of this offering, or, with respect to any particular stockholder, when such stockholder is able to sell all of its shares pursuant to Rule 144 of the Securities Act or a similar exemption in any three-month period.

Holders of substantially all of our shares with these registration rights have signed agreements with the underwriters or us prohibiting the exercise of their registration rights for 180 days, subject to possible extension of up to 35 additional days beyond the end of such 180-day period, following the date of this prospectus. These agreements are described below under the section entitled "Underwriters."

Anti-Takeover Effects of Delaware Law and Our Charter Documents

Some of the provisions of Delaware law may have the effect of delaying, deferring, discouraging or preventing another person from acquiring control of our company.

[Table of Contents](#)

We are subject to the provisions of Section 203 of the Delaware General Corporation Law regulating corporate takeovers. This section prevents some Delaware corporations from engaging, under some circumstances, in a business combination, which includes a merger or sale of at least 10% of the corporation's assets with any interested stockholder, meaning a stockholder who owns 15% or more of the corporation's outstanding voting stock, or is an affiliate or associate of the corporation and within three years prior to the determination of interested stockholder status, did own 15% or more of the corporation's outstanding voting stock, or is an affiliate or associate of such person unless:

- the transaction is approved by the board of directors prior to the time that the interested stockholder became an interested stockholder;
- upon consummation of the transaction which resulted in the stockholder's becoming an interested stockholder, the interested stockholder owned at least 85% of the voting stock of the corporation outstanding at the time the transaction commenced; or
- at or subsequent to such time that the stockholder became an interested stockholder the business combination is approved by the board of directors and authorized at an annual or special meeting of stockholders by at least two-thirds of the outstanding voting stock which is not owned by the interested stockholder.

A Delaware corporation may "opt out" of these provisions with an express provision in its original certificate of incorporation or an express provision in its certificate of incorporation or bylaws resulting from a stockholders' amendment approved by at least a majority of the outstanding voting shares. We do not plan to "opt out" of these provisions. The statute could prohibit or delay mergers or other takeover or change in control attempts and, accordingly, may discourage attempts to acquire us.

Certain provisions in our amended and restated certificate of incorporation and our amended and restated bylaws that will be in effect upon the closing of this offering could have an effect of delaying, deferring or preventing a change in control. For a description of such provisions, see "Risk Factors—Our charter documents and Delaware law could prevent a takeover that stockholders consider favorable and could also reduce the market price of our stock."

Choice of Forum

Our amended and restated certificate of incorporation will provide that the Court of Chancery of the State of Delaware will be the exclusive forum for any derivative action or proceeding brought on our behalf, any action asserting a breach of fiduciary duty owed by any director, officer or employee to us or our stockholders, any action asserting a claim against us arising pursuant to the Delaware General Corporation Law or any action asserting a claim against us that is governed by the internal affairs doctrine. However, several lawsuits involving other companies have been brought challenging the validity of choice of forum provisions in certificates of incorporation, and it is possible that a court could rule that such provision is inapplicable or unenforceable.

Listing

We have applied for the listing of our common stock on the NASDAQ Global Market under the trading symbol "ENPH."

Transfer Agent and Registrar

Upon the completion of this offering, the transfer agent and registrar for our common stock will be American Stock Transfer & Trust Company, LLC.

SHARES ELIGIBLE FOR FUTURE SALE

Prior to this offering, there has not been any public market for our common stock, and we make no prediction as to the effect, if any, that market sales of shares of our common stock or the availability of shares of our common stock for sale will have on the market price of our common stock prevailing from time to time. Nevertheless, sales of substantial amounts of our common stock in the public market, or the perception that such sales could occur, could adversely affect the market price of our common stock and could impair our future ability to raise capital through the sale of equity securities.

Based on the number of shares of common stock outstanding as of December 31, 2011, upon completion of this offering we will have an aggregate of 37,328,347 shares of common stock outstanding, assuming no exercise of the underwriters' over-allotment option and no exercise of outstanding options. Of the outstanding shares, all of the 7,272,727 shares sold in this offering, plus any additional shares sold upon exercise of the underwriters' over-allotment option, will be freely tradable, except that any shares purchased by "affiliates" (as that term is defined in Rule 144 under the Securities Act), may only be sold in compliance with the limitations described below. The remaining 30,055,620 shares of common stock will be deemed "restricted securities" as defined in Rule 144. Restricted securities may be sold in the public market only if the sale is registered or if the sale qualifies for an exemption from registration under Rule 144 or Rule 701, promulgated under the Securities Act, which rules are summarized below.

As a result of the contractual lock-up restrictions described below and the provisions of Rules 144 and 701, the restricted shares will be available for sale in the public market as follows:

- no shares will be eligible for sale immediately upon completion of this offering; and
- 30,055,620 shares will be eligible for sale upon the expiration of lock-up agreements, subject in some cases to volume and other restrictions of Rule 144 and Rule 701 under the Securities Act.

The number of shares eligible for sale upon expiration of lock-up agreements assumes (1) the conversion of all outstanding shares of our preferred stock into an aggregate of 25,170,918 shares of common stock and (2) the automatic conversion of the outstanding principal amount of our junior secured convertible loan facility and paid-in-kind interest as of December 31, 2011 into 3,186,644 shares of common stock upon closing of this offering at a conversion price equal to \$6.50, the midpoint of the price range set forth on the cover page of this prospectus.

However, because the number of shares of common stock that will be issued upon conversion of our junior secured convertible loan facility depends upon the actual initial public offering price per share in this offering and the closing date of this offering, the actual number of shares issuable upon such conversion may be different from the amounts we have assumed for purposes of this discussion. See "Prospectus Summary—The Offering."

Lock-Up Agreements and Obligations

We, all of our directors and executive officers and substantially all of our stockholders have entered into lock-up agreements that generally provide that we and they will not (1) offer, pledge, sell, contract to sell, sell any option or contract to purchase, purchase any option or contract to sell, grant any option, right or warrant to purchase, or otherwise transfer or dispose of, directly or indirectly, any shares of common stock or any securities convertible into or exchangeable for shares of common stock, or (2) enter into any swap or other agreement that transfers, in whole or in part, any of the economic consequences of ownership of any shares of common stock or such other securities, without the prior written consent of Morgan Stanley & Co. LLC for a period of 180 days from the date of this prospectus, subject to certain exceptions described under the heading "Underwriters."

[Table of Contents](#)

The 180-day restricted period described above is subject to extension such that, in the event that either (1) during the last 17 days of the 180-day restricted period, we issue an earnings release or material news or a material event relating to us occurs; or (2) prior to the expiration of the 180-day restricted period, we announce that we will release earnings results during the 16-day period beginning on the last day of the 180-day period, the restrictions described above will continue to apply until the expiration of the 18-day period beginning on the issuance of the earnings release or the occurrence of the material new or material event.

In addition, each grant agreement under our 2006 Equity Incentive Plan contains restrictions similar to those set forth in the lock-up agreements described above limiting the disposition of securities issuable pursuant to those plans for a period of at least 180 days following the date of this prospectus.

Rule 144

In general, under Rule 144 of the Securities Act as currently in effect, once we have been subject to public company reporting requirements for at least 90 days, a person who is not deemed to have been one of our affiliates for purposes of the Securities Act at any time during 90 days preceding a sale and who has beneficially owned the shares proposed to be sold for at least six months, including the holding period of any prior owner other than our affiliates, is entitled to sell such shares without complying with the manner of sale, volume limitation or notice provisions of Rule 144, subject to compliance with the public information requirements of Rule 144. If such a person has beneficially owned the shares proposed to be sold for at least one year, including the holding period of any prior owner other than our affiliates, then such person is entitled to sell such shares without complying with any of the requirements of Rule 144.

In general, under Rule 144, as currently in effect, our affiliates or persons selling shares on behalf of our affiliates are entitled to sell, upon expiration of the lock-up agreements described above and under the section "Underwriters", within any three-month period beginning 90 days after the date of this prospectus, a number of shares that does not exceed the greater of:

- 1% of the number of shares of common stock then outstanding, which will equal approximately 373,283 shares immediately after this offering, based on shares of common stock outstanding on December 31, 2011 and the other assumptions set forth above; or
- the average weekly trading volume of the common stock during the four calendar weeks preceding the filing of a notice on Form 144 with respect to such sale.

Sales under Rule 144 by our affiliates or persons selling shares on behalf of our affiliates are also subject to certain manner of sale provisions and notice requirements and to the availability of current public information about us.

Rule 701

Rule 701 generally allows a stockholder who purchased shares of our common stock pursuant to a written compensatory plan or contract and who is not deemed to have been an affiliate of our company during the immediately preceding 90 days to sell these shares in reliance upon Rule 144, but without being required to comply with the public information, holding period, volume limitation or notice provisions of Rule 144. Rule 701 also permits affiliates of our company to sell their Rule 701 shares under Rule 144 without complying with the holding period requirements of Rule 144. All holders of Rule 701 shares, however, are required to wait until 90 days after the date of this prospectus before selling such shares pursuant to Rule 701. However, substantially all Rule 701 shares are subject to lock-up agreements as described above and under the section "Underwriters" and will become eligible for sale at the expiration of those agreements.

As of December 31, 2011, 762,795 shares of our outstanding common stock had been issued in reliance on Rule 701 as a result of exercises of stock options and stock awards. These shares will be eligible for resale in reliance on this rule upon the expiration of the lock-up agreements described above.

Stock Plans

We intend to file registration statements on Form S-8 under the Securities Act covering all of the shares of our common stock subject to options outstanding or reserved for issuance under our stock plans, including our 2011 Employee Stock Purchase Plan. We expect to file this registration statement as soon as practicable after this offering. Accordingly, shares registered under the registration statement on Form S-8 will be available for sale in the open market following its effective date, subject to the lock-up agreements described above and the Rule 144 limitations applicable to affiliates.

Registration Rights

Upon completion of this offering, the holders of an aggregate of 29,747,889 shares of our common stock and 293,474 shares of common stock issuable upon the exercise of outstanding warrants, based on shares of common stock and warrants outstanding on December 31, 2011, or their transferees, will be entitled to rights with respect to the registration of their shares under the Securities Act. Registration of these shares under the Securities Act will result in these shares becoming freely tradable without restriction under the Securities Act immediately upon the effectiveness of such registration. For a further description of these rights, see the section entitled “Description of Capital Stock—Registration Rights.”

MATERIAL U.S. FEDERAL INCOME AND ESTATE TAX CONSEQUENCES TO NON-U.S. HOLDERS

The following summary describes the material U.S. federal income and estate tax consequences of the acquisition, ownership and disposition of our common stock acquired in this offering by Non-U.S. Holders (as defined below). This discussion does not address all aspects of U.S. federal income and estate taxes and does not deal with foreign, state and local consequences that may be relevant to Non-U.S. Holders in light of their particular circumstances, nor does it address U.S. federal tax consequences other than income and estate taxes. Special rules different from those described below may apply to certain Non-U.S. Holders that are subject to special treatment under the Internal Revenue Code of 1986, as amended, or the Code, such as financial institutions, insurance companies, tax-exempt organizations, broker-dealers and traders in securities, U.S. expatriates, “controlled foreign corporations,” “passive foreign investment companies,” corporations that accumulate earnings to avoid U.S. federal income tax, persons that hold our common stock as part of a “straddle,” “hedge,” “conversion transaction,” “synthetic security” or integrated investment or other risk reduction strategy, partnerships and other pass-through entities, and investors in such pass-through entities or an entity that is treated as a disregarded entity for U.S. federal income tax purposes (regardless of its place of organization or formation). Such Non-U.S. Holders are urged to consult their own tax advisors to determine the U.S. federal, state, local and other tax consequences that may be relevant to them. Furthermore, the discussion below is based upon the provisions of the Code, and Treasury regulations, rulings and judicial decisions thereunder as of the date hereof, and such authorities may be repealed, revoked or modified, perhaps retroactively, so as to result in U.S. federal income and estate tax consequences different from those discussed below. We have not requested a ruling from the U.S. Internal Revenue Service, or IRS, with respect to the statements made and the conclusions reached in the following summary, and there can be no assurance that the IRS will agree with such statements and conclusions. This discussion assumes that the Non-U.S. Holder holds our common stock as a “capital asset” within the meaning of Section 1221 of the Code (generally, property held for investment).

Persons considering the purchase of our common stock pursuant to this offering should consult their own tax advisors concerning the U.S. federal income and estate tax consequences of acquiring, owning and disposing of our common stock in light of their particular situations as well as any consequences arising under the laws of any other taxing jurisdiction, including any state, local or foreign tax consequences.

For the purposes of this discussion, a “Non-U.S. Holder” is, for U.S. federal income tax purposes, a beneficial owner of common stock that is not a U.S. Holder, a partnership or other pass-through entity, or a disregarded entity. A “U.S. Holder” means a beneficial owner of our common stock that is for U.S. federal income tax purposes (a) an individual who is a citizen or resident of the United States, (b) a corporation or other entity treated as a corporation created or organized in or under the laws of the United States, any state thereof or the District of Columbia, (c) an estate the income of which is subject to U.S. federal income taxation regardless of its source or (d) a trust if it (1) is subject to the primary supervision of a court within the United States and one or more U.S. persons have the authority to control all substantial decisions of the trust or (2) has a valid election in effect under applicable U.S. Treasury regulations to be treated as a U.S. person.

Distributions

Subject to the discussion below, distributions, if any, made on our common stock to a Non-U.S. Holder of our common stock to the extent made out of our current or accumulated earnings and profits (as determined under U.S. federal income tax principles) generally will constitute dividends for U.S. tax purposes and will be subject to withholding tax at a 30% rate or such lower rate as may be specified by an applicable income tax treaty. To obtain a reduced rate of withholding under a treaty, a Non-U.S. Holder generally will be required to provide us with a properly executed IRS Form W-8BEN, or other appropriate form, certifying the Non-U.S. Holder’s entitlement to benefits under that treaty. In the case of a Non-U.S. Holder that is an entity, Treasury Regulations and the relevant tax treaty provide rules to determine whether, for purposes of determining the applicability of a tax treaty, dividends will be treated as paid to the entity or to those holding an interest in that

[Table of Contents](#)

entity. If a Non-U.S. Holder holds stock through a financial institution or other agent acting on the holder's behalf, the holder will be required to provide appropriate documentation to such agent. The holder's agent will then be required to provide certification to us or our paying agent, either directly or through other intermediaries. If you are eligible for a reduced rate of U.S. federal withholding tax under an income tax treaty, you should consult with your own tax advisor to determine if you are able to obtain a refund or credit of any excess amounts withheld by timely filing an appropriate claim for a refund with the IRS.

We generally are not required to withhold tax on dividends paid to a Non-U.S. Holder that are effectively connected with the Non-U.S. Holder's conduct of a trade or business within the United States (and, if required by an applicable income tax treaty, are attributable to a permanent establishment that such holder maintains in the United States) if a properly executed IRS Form W-8ECI, stating that the dividends are so connected, is furnished to us (or, if stock is held through a financial institution or other agent, to such agent). In general, such effectively connected dividends will be subject to U.S. federal income tax, on a net income basis at the regular graduated rates generally in the same manner as a U.S. person. A corporate Non-U.S. Holder receiving effectively connected dividends may also be subject to an additional "branch profits tax," which is imposed, under certain circumstances, at a rate of 30% (or such lower rate as may be specified by an applicable treaty) on the corporate Non-U.S. Holder's effectively connected earnings and profits, subject to certain adjustments.

To the extent distributions on our common stock, if any, exceed our current and accumulated earnings and profits, they will constitute a non-taxable return of capital and will first reduce your adjusted basis in our common stock, but not below zero, and then will be treated as gain and taxed in the same manner as gain realized from a sale or other disposition of common stock as described in the next section.

Gain on Disposition of Our Common Stock

A Non-U.S. Holder generally will not be subject to U.S. federal income tax with respect to gain realized on a sale or other disposition of our common stock unless (a) the gain is effectively connected with a trade or business of such holder in the United States (and, if required by an applicable income tax treaty, is attributable to a permanent establishment that such holder maintains in the United States), (b) the Non-U.S. Holder is a nonresident alien individual and is present in the United States for 183 or more days in the taxable year of the disposition and certain other conditions are met, or (c) we are or have been a "United States real property holding corporation" within the meaning of Code Section 897(c)(2) at any time within the shorter of the five-year period preceding such disposition or such holder's holding period. In general, we would be a United States real property holding corporation if interests in U.S. real estate comprised (by fair market value) at least half of our business assets. We believe that we are not, and do not anticipate becoming, a United States real property holding corporation. Even if we are treated as a United States real property holding corporation, gain realized by a Non-U.S. Holder on a disposition of our common stock will not be subject to U.S. federal income tax so long as (1) the Non-U.S. Holder owned, directly, indirectly and constructively, no more than five percent of our common stock at all times within the shorter of (i) the five-year period preceding the disposition or (ii) the holder's holding period and (2) our common stock is regularly traded on an established securities market. There can be no assurance that our common stock will continue to qualify as regularly traded on an established securities market.

If you are a Non-U.S. Holder described in (a) above, you will be required to pay tax on the net gain derived from the sale at regular graduated U.S. federal income tax rates generally in the same manner as a U.S. person, and corporate Non-U.S. Holders described in (a) above may be subject to the additional branch profits tax at a 30% rate or such lower rate as may be specified by an applicable income tax treaty. If you are an individual Non-U.S. Holder described in (b) above, you will be required to pay a flat 30% tax on the gain derived from the sale, which gain may be offset by U.S. source capital losses (even though you are not considered a resident of the United States).

Information Reporting Requirements and Backup Withholding

Generally, we or certain financial middlemen must report information to the IRS with respect to any dividends we pay on our common stock including the amount of any such dividends, the name and address of the

[Table of Contents](#)

recipient, and the amount, if any, of tax withheld. A similar report is sent to the holder to whom any such dividends are paid. Pursuant to tax treaties or certain other agreements, the IRS may make its reports available to tax authorities in the recipient's country of residence.

Dividends paid by us (or our paying agents) to a Non-U.S. Holder may also be subject to U.S. backup withholding. U.S. backup withholding generally will not apply to a Non-U.S. Holder who provides a properly executed IRS Form W-8BEN or otherwise establishes an exemption. The current backup withholding rate is 28%.

Under current U.S. federal income tax law, U.S. information reporting and backup withholding requirements generally will apply to the proceeds of a disposition of our common stock effected by or through a U.S. office of any broker, U.S. or foreign, except that information reporting and such requirements may be avoided if the holder provides a properly executed IRS Form W-8BEN, satisfies documentary evidence requirements for establishing Non-U.S. Holder status or otherwise establishes an exemption. Generally, U.S. information reporting and backup withholding requirements will not apply to a payment of disposition proceeds to a Non-U.S. Holder where the transaction is effected outside the United States through a non-U.S. office of a non-U.S. broker. Information reporting and backup withholding requirements may, however, apply to a payment of disposition proceeds if the broker has actual knowledge, or reason to know, that the holder is, in fact, a U.S. person. For information reporting purposes, certain brokers with substantial U.S. ownership or operations will generally be treated in a manner similar to U.S. brokers.

If backup withholding is applied to you, you should consult with your own tax advisor to determine if you are able to obtain a tax benefit or credit with respect to such backup withholding.

Legislation Affecting Taxation of Our Common Stock Held by or Through Foreign Entities

Legislation enacted in 2010 generally will impose a U.S. federal withholding tax of 30% on dividends and the gross proceeds of a disposition of our common stock paid to a foreign financial institution (as specifically defined for this purpose) unless such institution enters into an agreement with the U.S. government to withhold on certain payments and to collect and provide to the U.S. tax authorities substantial information regarding U.S. account holders of such institution (which includes certain equity and debt holders of such institution, as well as certain account holders that are foreign entities with U.S. owners). The legislation also will generally impose a U.S. federal withholding tax of 30% on dividends and the gross proceeds of a disposition of our common stock paid to a non-financial foreign entity unless such entity provides the withholding agent with either a certification that it does not have any substantial direct or indirect U.S. owners or provides information regarding direct and indirect U.S. owners of the entity. Under certain transition rules, the withholding would apply to dividends paid in respect of our common stock after December 31, 2013, and gross proceeds of a disposition of our common stock after December 31, 2014. Under certain circumstances, a Non-U.S. Holder might be eligible for refunds or credits of such taxes. Holders are encouraged to consult with their own tax advisors regarding the possible implications of the legislation on their investment in our common stock.

Federal Estate Tax

An individual Non-U.S. Holder who is treated as the owner of, or has made certain lifetime transfers of, an interest in our common stock will be required to include the value thereof in his or her gross estate for U.S. federal estate tax purposes, and may be subject to U.S. federal estate tax unless an applicable estate tax treaty provides otherwise, even though such individual was not a citizen or resident of the United States at the time of his or her death.

EACH PROSPECTIVE INVESTOR SHOULD CONSULT ITS OWN TAX ADVISOR REGARDING THE TAX CONSEQUENCES OF PURCHASING, HOLDING AND DISPOSING OF OUR COMMON STOCK, INCLUDING THE CONSEQUENCES OF ANY PROPOSED CHANGE IN APPLICABLE LAW.

UNDERWRITERS

Under the terms and subject to the conditions in an underwriting agreement dated the date of this prospectus, the underwriters named below, for whom Morgan Stanley & Co. LLC, Merrill Lynch, Pierce, Fenner & Smith Incorporated and Deutsche Bank Securities Inc. are acting as representatives, have severally agreed to purchase, and we have agreed to sell to them, severally, the number of shares indicated below:

<u>Name</u>	<u>Number of Shares</u>
Morgan Stanley & Co. LLC	
Merrill Lynch, Pierce, Fenner & Smith Incorporated	
Deutsche Bank Securities Inc.	
Jefferies & Company, Inc.	
Lazard Capital Markets LLC	
ThinkEquity LLC	
Total	<u>7,272,727</u>

The underwriters and the representatives are collectively referred to as the “underwriters” and the “representatives,” respectively. The underwriters are offering the shares of common stock subject to their acceptance of the shares from us and subject to prior sale. The underwriting agreement provides that the obligations of the several underwriters to pay for and accept delivery of the shares of common stock offered by this prospectus are subject to the approval of certain legal matters by their counsel and to certain other conditions. The underwriters are obligated to take and pay for all of the shares of common stock offered by this prospectus if any such shares are taken. However, the underwriters are not required to take or pay for the shares covered by the underwriters’ option to purchase additional shares described below.

The underwriters initially propose to offer part of the shares of common stock directly to the public at the offering price listed on the cover page of this prospectus and part to certain dealers at a price that represents a concession not in excess of \$ _____ per share. After the initial offering of the shares of common stock, the offering price and other selling terms may from time to time be varied by the representative.

We have granted to the underwriters an option, exercisable for 30 days from the date of this prospectus, to purchase up to 1,090,909 additional shares of common stock at the public offering price listed on the cover page of this prospectus, less underwriting discounts and commissions. The underwriters may exercise this option solely for the purpose of covering over-allotments, if any, made in connection with the offering of the shares of common stock offered by this prospectus. To the extent the option is exercised, each underwriter will become obligated, subject to certain conditions, to purchase about the same percentage of the additional shares of common stock as the number listed next to the underwriter’s name in the preceding table bears to the total number of shares of common stock listed next to the names of all underwriters in the preceding table.

Entities affiliated with Third Point, Madrone, KPCB and Bay Partners have indicated an interest in purchasing up to an aggregate of \$15.0 million of shares of our common stock in this offering at the price offered to the public. As of March 1, 2012, each of Third Point, Madrone, KPCB and Bay Partners beneficially owned more than 5% of our common stock and each is affiliated with a member of our board of directors. Because these indications of interest are not binding agreements or commitments to purchase, these stockholders may elect not to purchase shares in this offering or the underwriters may elect not to sell any shares in this offering to such stockholders. The underwriters will not receive any underwriting discounts or commissions from any sales of shares to these existing stockholders.

The estimated offering expenses payable by us, in addition to the underwriting discounts and commissions, are approximately \$3.8 million.

[Table of Contents](#)

The following table shows the per share and total public offering price, underwriting discounts and commissions, and proceeds before expenses to us. These amounts are shown assuming both no exercise and full exercise of the underwriters' option to purchase up to an additional 1,090,909 shares of common stock.

	Total		
	Per Share	No Exercise	Full Exercise
Public offering price	\$	\$	\$
Underwriting discounts and commissions to be paid by us	\$	\$	\$
Proceeds, before expenses, to us	\$	\$	\$

The underwriters have informed us that they do not intend sales to discretionary accounts to exceed 5% of the total number of shares of common stock offered by them.

We have applied to list our common stock on the NASDAQ Global Market under the symbol "ENPH."

We and all directors and officers and the holders of substantially all of our outstanding stock and stock options have agreed that, without the prior written consent of Morgan Stanley & Co. LLC on behalf of the underwriters, we and they will not, during the period ending 180 days after the date of this prospectus:

- offer, pledge, sell, contract to sell, sell any option or contract to purchase, purchase any option or contract to sell, grant any option, right or warrant to purchase, lend, or otherwise transfer or dispose of, directly or indirectly, any shares of common stock or any securities convertible into or exercisable or exchangeable for shares of common stock;
- enter into any swap or other arrangement that transfers to another, in whole or in part, any of the economic consequences of ownership of the common stock; or
- file any registration statement with the Securities and Exchange Commission relating to the offering of any shares of common stock or any securities convertible into or exercisable or exchangeable for common stock.

Whether any such transaction described in the first two bullet points above is to be settled by delivery of common stock or such other securities, in cash or otherwise. In addition, we and each such person agree that, without the prior written consent of Morgan Stanley & Co. LLC on behalf of the underwriters, we and such persons will not, during the period ending 180 days after the date of this prospectus, make any demand for, or exercise any right with respect to, the registration of any shares of common stock or any security convertible into or exercisable or exchangeable for common stock.

The restrictions described in the two immediately preceding paragraphs do not apply to:

- the sale by us of shares of common stock pursuant to the underwriting agreement;
- the issuance by us of shares of common stock upon the exercise of an option or a warrant or the conversion of a security outstanding on the date of this prospectus and as described in this prospectus;
- transactions by a director, officer or stockholder relating to shares of common stock or other securities acquired in open market transactions after the completion of the offering of the shares; provided that no filing under Section 16(a) of the Securities Exchange Act of 1934, as amended, is required or voluntarily made in connection with subsequent sales of the common stock or other securities acquired in such open market transactions;
- transfers of shares of common stock or any securities convertible into common stock by a director, officer or stockholder (i) as a bona fide gift, (ii) by will or intestate succession or (iii) to any trust for the direct or indirect benefit of the director, officer, stockholder or an immediate family member,

[Table of Contents](#)

provided that it shall be a condition of the transfer that each transferee or donee shall sign and deliver a copy of the lock-up agreement prior to or upon such transfer and no filing under Section 16(a) of the Exchange Act reporting a disposition of shares of common stock or any other reduction in beneficial ownership of shares of common stock shall be required or shall be made voluntarily during the 180-day restricted period;

- transfers or distributions of shares of common stock or any securities convertible into common stock by a stockholder that is a corporation, partnership, limited liability company or other business entity (i) to any stockholder, partner or member of, or owner of a similar equity interest in, such stockholder, as the case may be, (ii) in connection with the sale or other bona fide transfer in a single transaction of all or substantially all of the stockholder's capital stock, partnership interests, membership interests or other similar equity interests, as the case may be, or all or substantially all of the stockholder's assets, in any such case not undertaken for the purpose of avoiding the restrictions imposed by the lock-up agreement or (iii) to another corporation, partnership, limited liability company or other business entity so long as the transferee is an affiliate of the stockholder, provided that it shall be a condition of the transfer that each transferee or donee shall sign and deliver a copy of the lock-up agreement prior to or upon such transfer and no filing under Section 16(a) of the Exchange Act reporting a disposition of shares of common stock or any other reduction in beneficial ownership of shares of common stock shall be required or shall be made voluntarily during the 180-day restricted period;
- the establishment by a director, officer or stockholder of a trading plan pursuant to Rule 10b5-1 under the Securities Exchange Act of 1934, as amended, for the transfer of shares of common stock, provided that such plan does not provide for the transfer of common stock during the restricted period and no public announcement or filing under the Securities Exchange Act of 1934, as amended, regarding the establishment of such plan shall be required or shall be voluntarily made;
- the exercise of options granted under our 2006 Equity Incentive Plan, 2011 Equity Incentive Plan, or 2011 Employee Stock Purchase Plan or warrants outstanding on the date of this prospectus, in each case by a director, officer or stockholder, provided that it shall be a condition of the transfer that shares received upon such exercise shall be subject to the lock-up restrictions and no filing under Section 16(a) of the Exchange Act reporting the disposition of shares of common stock or any other reduction in the beneficial ownership of shares is required or voluntarily made in connection with these transactions during this 180-day restricted period;
- the issuance by us of shares of common stock, or other securities convertible into or exercisable for common stock, stock pursuant to our equity incentive plans described in this prospectus, provided that the recipient of such shares or options shall sign and deliver a copy of the lock-up agreement to the extent such shares or options become vested within 180 days after the date of this prospectus;
- the entry by us into an agreement to issue shares of our common stock or any security convertible into or exercisable for shares of our common stock in connection with our acquisition of the securities, business, property or assets of another person, or in connection with joint ventures, commercial relationships or other strategic transactions, in an aggregate amount not to exceed 5% of the total number of shares of our common stock issued and outstanding immediately following the completion of the offering, *provided* that each recipient of these securities shall execute a lock-up agreement and we shall enter stop transfer instructions with our transfer agent and registrar, which we will not waive or amend without the prior written consent of Morgan Stanley & Co. LLC on behalf of the underwriters;
- transfers by a director, officer or stockholder to us of shares of common stock or other securities convertible into or exercisable or exchangeable for common stock (i) upon a vesting event of such securities or the exercise of options issued pursuant to our 2006 Equity Incentive Plan, 2011 Equity Incentive Plan, or 2011 Employee Stock Purchase Plan in full or partial payment of taxes or tax withholding obligations required to be paid or satisfied upon such vesting or exercise or (ii) in exercise of our right to repurchase or reacquire securities pursuant to agreements that permit us to repurchase or

[Table of Contents](#)

reacquire such securities upon termination of services to the company, provided that it shall be a condition of the transfer that no filing under Section 16(a) of the Exchange Act, reporting a disposition of shares of Common Stock or any other reduction in beneficial ownership of shares of Common Stock, shall be required or shall be voluntarily made during this 180-day restricted period;

- transfers by a director, officer or stockholder of shares of common stock acquired pursuant to our 2011 Employee Stock Purchase Plan, provided that it shall be a condition of the transfer that no filing under Section 16(a) of the Exchange Act shall be required or shall be voluntarily made in connection with such transfer during this 180-day restricted period;
- transfers by a director, officer or stockholder pursuant to a sale or an offer to purchase 100% of our outstanding common stock, whether pursuant to a merger, tender offer or otherwise, to a third party or group of third parties; and
- the filing by us of a registration statement on Form S-8 in respect of any shares issued under or the grant of any award pursuant to an employee benefit plan described in this prospectus.

The 180-day restricted period described in the immediately preceding paragraph will be extended if:

- during the last 17 days of the 180-day restricted period we issue an earnings release or material news or a material event relating to us occurs, or
- prior to the expiration of the 180-day restricted period, we announce that we will release earnings results during the 16-day period beginning on the last day of the 180-day period or provide notification to Morgan Stanley & Co. LLC of any earnings release or material news or material event that may give rise to an extension of the initial 180-day restricted period,

in which case the restrictions described in the immediately preceding paragraph will continue to apply until the expiration of the 18 day period beginning on the issuance of the earnings release or the occurrence of the material news or material event.

Morgan Stanley & Co. LLC, in its sole discretion, may release the common stock and other securities subject to the lock-up agreements described above in whole or in part at any time with or without notice. When determining whether or not to release common stock and other securities from lock-up agreements, Morgan Stanley & Co. LLC will consider, among other factors, the holder's reasons for requesting the release, the number of shares of common stock and other securities for which the release is being requested and market conditions at the time.

In order to facilitate the offering of the common stock, the underwriters may engage in transactions that stabilize, maintain or otherwise affect the price of the common stock. Specifically, the underwriters may sell more shares than they are obligated to purchase under the underwriting agreement, creating a short position. A short sale is covered if the short position is no greater than the number of shares available for purchase by the underwriters under the option to purchase additional shares of common stock. The underwriters can close out a covered short sale by exercising the option to purchase additional shares of common stock or purchasing shares in the open market. In determining the source of shares to close out a covered short sale, the underwriters will consider, among other things, the open market price of shares compared to the price available under the option to purchase additional shares of common stock. The underwriters may also sell shares in excess of the option to purchase additional shares of common stock, creating a naked short position. The underwriters must close out any naked short position by purchasing shares in the open market. A naked short position is more likely to be created if the underwriters are concerned that there may be downward pressure on the price of the common stock in the open market after pricing that could adversely affect investors who purchase in this offering. As an additional means of facilitating the offering, the underwriters may bid for, and purchase, shares of common stock in the open market to stabilize the price of the common stock. These activities may raise or maintain the market

[Table of Contents](#)

price of the common stock above independent market levels or prevent or retard a decline in the market price of the common stock. The underwriters are not required to engage in these activities and may end any of these activities at any time.

We and the underwriters have agreed to indemnify each other against certain liabilities, including liabilities under the Securities Act.

A prospectus in electronic format may be made available on websites maintained by one or more underwriters, or selling group members, if any, participating in this offering. The representatives may agree to allocate a number of shares of common stock to underwriters for sale to their online brokerage account holders. Internet distributions will be allocated by the representatives to underwriters that may make Internet distributions on the same basis as other allocations.

The underwriters and their respective affiliates are full service financial institutions engaged in various activities, which may include securities trading, commercial and investment banking, financial advisory, investment management, principal investment, hedging, financing and brokerage activities. None of the underwriters have performed financial advisory or investment banking services for us other than in connection with this offering. However certain of the underwriters and their respective affiliates may in the future perform various financial advisory and investment banking services for us, for which they may receive customary fees and expenses. In February 2010, we entered into a commercial supply agreement and a related services agreement with MS Solar Solutions Corp., or MSSS, an affiliate of Morgan Stanley & Co. LLC, an underwriter in this offering. Under these agreements, MSSS purchases microinverters from us and then resells them to MSSS project companies in connection with the installation of solar PV systems in the United States. In connection with these agreements, MSSS received a three-year warrant to purchase 11,013 shares of our common stock. This warrant was issued in March 2010 and was exercisable contingent on MSSS purchasing at least 200,000 microinverters from us by March 2012. Such conditions were not satisfied prior to the required date, and therefore this warrant terminated on March 4, 2012. Morgan Stanley, an affiliate of Morgan Stanley & Co. LLC, has guaranteed the payment obligations of MSSS under the supply agreement. Morgan Stanley's liability under the guarantee is limited to \$100,000.

Lazard Frères & Co. LLC referred this transaction to Lazard Capital Markets LLC and will receive a referral fee from Lazard Capital Markets LLC in connection therewith.

Pricing of the Offering

Prior to this offering, there has been no public market for our common stock. The initial public offering price was determined by negotiations between us and the representatives. Among the factors considered in determining the initial public offering price were our future prospects and those of our industry in general, our sales, earnings and certain other financial and operating information in recent periods, and the price-earnings ratios, price-sales ratios, market prices of securities, and certain financial and operating information of companies engaged in activities similar to ours.

Selling Restrictions

European Economic Area

In relation to each Member State of the European Economic Area which has implemented the Prospectus Directive (each, a "Relevant Member State") an offer to the public of any shares of our common stock may not be made in that Relevant Member State, except that an offer to the public in that Relevant Member State of any shares of our common stock may be made at any time under the following exemptions under the Prospectus Directive, if they have been implemented in that Relevant Member State:

- (a) to any legal entity that is a qualified investor as defined in the Prospectus Directive;

Table of Contents

- (b) to fewer than 100 or, if the Relevant Member State has implemented the relevant provision of the 2010 PD Amending Directive, 150 natural or legal persons (other than qualified investors as defined in the Prospectus Directive), as permitted under the Prospectus Directive, subject to obtaining the prior consent of the representatives for any such offer; or
- (c) in any other circumstances falling within Article 3(2) of the Prospectus Directive, provided that no such offer of shares of our common stock shall result in a requirement for the publication by us or any underwriter of a prospectus pursuant to Article 3 of the Prospectus Directive.

For the purposes of this provision, the expression an “offer to the public” in relation to any shares of our common stock in any Relevant Member State means the communication in any form and by any means of sufficient information on the terms of the offer and any shares of our common stock to be offered so as to enable an investor to decide to purchase any shares of our common stock, as the same may be varied in that Member State by any measure implementing the Prospectus Directive in that Member State; the expression “Prospectus Directive” means Directive 2003/71/EC (and amendments thereto, including the 2010 PD Amending Directive, to the extent implemented in the Relevant Member State), and includes any relevant implementing measure in the Relevant Member State; and the expression “2010 PD Amending Directive” means Directive 2010/73/EU.

United Kingdom

Each underwriter has represented and agreed that:

- (a) it has only communicated or caused to be communicated and will only communicate or cause to be communicated an invitation or inducement to engage in investment activity (within the meaning of Section 21 of the FSMA) received by it in connection with the issue or sale of the shares of our common stock in circumstances in which Section 21(1) of the FSMA does not apply to us; and
- (b) it has complied and will comply with all applicable provisions of the FSMA with respect to anything done by it in relation to the shares of our common stock in, from or otherwise involving the United Kingdom.

Switzerland

We have not and will not register with the Swiss Financial Market Supervisory Authority, or FINMA, as a foreign collective investment scheme pursuant to Article 119 of the Federal Act on Collective Investment Scheme of 23 June 2006, as amended, or CISA, and accordingly the securities being offered pursuant to this prospectus have not and will not be approved, and may not be licenseable, with FINMA. Therefore, the securities have not been authorized for distribution by FINMA as a foreign collective investment scheme pursuant to Article 119 CISA and the securities offered hereby may not be offered to the public (as this term is defined in Article 3 CISA) in or from Switzerland. The securities may solely be offered to “qualified investors,” as this term is defined in Article 10 CISA, and in the circumstances set out in Article 3 of the Ordinance on Collective Investment Scheme of 22 November 2006, as amended, or CISO, such that there is no public offer. Investors, however, do not benefit from protection under CISA or CISO or supervision by FINMA. This prospectus and any other materials relating to the securities are strictly personal and confidential to each offeree and do not constitute an offer to any other person. This prospectus may only be used by those qualified investors to whom it has been handed out in connection with the offer described herein and may neither directly or indirectly be distributed or made available to any person or entity other than its recipients. It may not be used in connection with any other offer and shall in particular not be copied and/or distributed to the public in Switzerland or from Switzerland. This prospectus does not constitute an issue prospectus as that term is understood pursuant to Article 652a and/or 1156 of the Swiss Federal Code of Obligations. We have not applied for a listing of the securities on the SIX Swiss Exchange or any other regulated securities market in Switzerland, and consequently, the information presented in this prospectus does not necessarily comply with the information standards set out in the listing rules of the SIX Swiss Exchange and corresponding prospectus schemes annexed to the listing rules of the SIX Swiss Exchange.

Dubai International Financial Centre

This prospectus relates to an Exempt Offer in accordance with the Offered Securities Rules of the Dubai Financial Services Authority, or DFSA. This prospectus is intended for distribution only to persons of a type specified in the Offered Securities Rules of the DFSA. It must not be delivered to, or relied on by, any other person. The DFSA has no responsibility for reviewing or verifying any documents in connection with Exempt Offers. The DFSA has not approved this prospectus nor taken steps to verify the information set forth herein and has no responsibility for the prospectus. The shares to which this prospectus relates may be illiquid and/or subject to restrictions on their resale. Prospective purchasers of the shares offered should conduct their own due diligence on the shares. If you do not understand the contents of this prospectus you should consult an authorized financial advisor.

LEGAL MATTERS

The validity of the shares of common stock offered hereby will be passed upon for us by Cooley LLP, Palo Alto, California. Certain legal matters in connection with this offering will be passed upon for the underwriters by Davis Polk & Wardwell LLP, Menlo Park, California.

EXPERTS

The consolidated financial statements as of December 31, 2010 and 2011, and for each of the three years in the period ended December 31, 2011 included in this prospectus have been audited by Deloitte & Touche LLP, an independent registered public accounting firm, as stated in their report appearing herein and elsewhere in the registration statement. Such consolidated financial statements have been so included in reliance upon the report of such firm given upon their authority as experts in accounting and auditing.

WHERE YOU CAN FIND MORE INFORMATION

We have filed with the SEC a registration statement on Form S-1 under the Securities Act with respect to the shares of common stock we are offering. The registration statement, including the attached exhibits and schedules, contains additional relevant information about us and our common stock. This prospectus does not contain all of the information set forth in the registration statement and the exhibits and schedules thereto. The rules and regulations of the SEC allow us to omit from this prospectus certain information included in the registration statement.

For further information about us and our common stock, you may inspect a copy of the registration statement and the exhibits and schedules to the registration statement without charge at the offices of the SEC at 100 F Street, N.E., Washington, D.C. 20549. You may obtain copies of all or any part of the registration statement from the Public Reference Section of the SEC, 100 F Street, N.E., Washington, D.C. 20549 upon the payment of the prescribed fees. You may obtain information on the operation of the Public Reference Room by calling the SEC at 1-800-SEC-0330. The SEC maintains a website at www.sec.gov that contains reports, proxy and information statements and other information regarding registrants like us that file electronically with the SEC. You can also inspect our registration statement on this website.

Upon completion of this offering, we will become subject to the reporting and information requirements of the Exchange Act, and we will file reports, proxy statements and other information with the SEC.

[Table of Contents](#)

ENPHASE ENERGY, INC.
INDEX TO CONSOLIDATED FINANCIAL STATEMENTS AS OF
DECEMBER 31, 2010 AND 2011, AND FOR THE YEARS ENDED
DECEMBER 31, 2009, 2010 AND 2011

[Report of Independent Registered Public Accounting Firm](#)

[Consolidated Balance Sheets](#)

[Consolidated Statements of Operations](#)

[Consolidated Statements of Stockholders' Equity](#)

[Consolidated Statements of Cash Flows](#)

[Notes to Consolidated Financial Statements](#)

Page

F-2

F-3

F-4

F-5

F-6

F-7

F-1

REPORT OF INDEPENDENT REGISTERED PUBLIC ACCOUNTING FIRM

To the Board of Directors and Shareholders of Enphase Energy, Inc.:

We have audited the accompanying consolidated balance sheets of Enphase Energy, Inc. and subsidiaries (the "Company") as of December 31, 2010 and 2011, and the related consolidated statements of operations, stockholders' equity, and cash flows for each of the three years in the period ended December 31, 2011. These consolidated financial statements are the responsibility of the Company's management. Our responsibility is to express an opinion on these consolidated financial statements based on our audits.

We conducted our audits in accordance with the standards of the Public Company Accounting Oversight Board (United States). Those standards require that we plan and perform the audit to obtain reasonable assurance about whether the financial statements are free of material misstatement. The Company is not required to have, nor were we engaged to perform, an audit of its internal control over financial reporting. Our audit includes consideration of internal control over financial reporting as a basis for designing audit procedures that are appropriate in the circumstances, but not for the purpose of expressing an opinion on the effectiveness of the Company's internal control over financial reporting. Accordingly, we express no such opinion. An audit also includes examining, on a test basis, evidence supporting the amounts and disclosures in the financial statements, assessing the accounting principles used and significant estimates made by management, as well as evaluating the overall financial statement presentation. We believe that our audits provide a reasonable basis for our opinion.

In our opinion, such consolidated financial statements present fairly, in all material respects, the financial position of Enphase Energy, Inc. and subsidiaries as of December 31, 2010 and 2011, and the results of their operations and their cash flows for each of the three years in the period ended December 31, 2011, in conformity with accounting principles generally accepted in the United States of America.

/s/ Deloitte & Touche LLP

San Francisco, California

February 22, 2012 (March 28, 2012 as to the effects of the reverse split described in the first paragraph of Note 17 and the second paragraph of Note 17)

ENPHASE ENERGY, INC.
Consolidated Balance Sheets
(in thousands, except per share data)

	<u>December 31,</u>		Pro Forma
	<u>2010</u>	<u>2011</u>	December 31, 2011 (See Note 2) (unaudited)
ASSETS			
Current Assets:			
Cash and cash equivalents	\$ 39,993	\$ 51,524	\$ 51,524
Accounts receivables, net of allowances of \$16 and \$144, respectively	8,024	17,771	17,771
Inventory	4,521	11,228	11,228
Prepaid expenses and other	418	1,264	1,264
Total current assets	52,956	81,787	81,787
Property and equipment, net	6,103	18,411	18,411
Other assets	445	6,044	4,561
Total assets	<u>\$ 59,504</u>	<u>\$ 106,242</u>	<u>\$ 104,759</u>
LIABILITIES AND STOCKHOLDERS' EQUITY			
Current liabilities:			
Accounts payable	\$ 6,521	\$ 12,928	\$ 12,928
Accrued liabilities	2,910	10,100	10,100
Deferred revenues	595	23,414	23,414
Current portion of term loans	2,567	4,529	4,529
Convertible preferred stock warrant liability	610	1,399	—
Total current liabilities	13,203	52,370	50,971
Long-term liabilities:			
Deferred revenues	1,044	3,670	3,670
Warranty obligations	2,328	6,733	6,733
Other liabilities	112	145	145
Term loans	4,336	10,148	10,148
Convertible notes	—	19,202	—
Total long-term liabilities	7,820	39,898	20,696
Total liabilities	21,023	92,268	71,667
Commitments and contingencies			
Stockholders' equity:			
Convertible preferred stock, \$0.00001 par value; 23,559 shares authorized; 22,221 shares issued and outstanding at December 31, 2010 and 2011; aggregate liquidation preference of \$133,142 at December 31, 2010 and 2011; no shares authorized, issued or outstanding pro forma	93,596	93,596	—
Common stock, \$0.00001 par value; 41,410 shares authorized; 843 and 1,698 shares issued and outstanding at December 31, 2010 and 2011, respectively	—	—	—
Additional paid-in capital	1,403	9,103	124,811
Accumulated deficit	(56,518)	(88,808)	(91,802)
Accumulated other comprehensive income	—	83	83
Total stockholders' equity	38,481	13,974	33,092
Total liabilities and stockholders' equity	<u>\$ 59,504</u>	<u>\$ 106,242</u>	<u>\$ 104,759</u>

See notes to consolidated financial statements.

ENPHASE ENERGY, INC.
Consolidated Statements of Operations
(in thousands, except per share data)

	Year Ended December 31,		
	2009	2010	2011
Net revenues	\$ 20,194	\$ 61,661	\$ 149,523
Cost of revenues	23,223	55,159	120,454
Gross profit (loss)	<u>(3,029)</u>	<u>6,502</u>	<u>29,069</u>
Operating expenses:			
Research and development	8,411	14,296	25,099
Sales and marketing	2,651	6,558	17,454
General and administrative	2,603	6,365	15,228
Total operating expenses	<u>13,665</u>	<u>27,219</u>	<u>57,781</u>
Loss from operations	<u>(16,694)</u>	<u>(20,717)</u>	<u>(28,712)</u>
Other income (expense), net:			
Interest income	125	39	4
Interest expense	(356)	(914)	(3,006)
Other income (expense)	—	(185)	(576)
Total other income (expense), net	<u>(231)</u>	<u>(1,060)</u>	<u>(3,578)</u>
Net loss attributable to common stockholders	<u>\$ (16,925)</u>	<u>\$ (21,777)</u>	<u>\$ (32,290)</u>
Net loss per share attributable to common stockholders, basic and diluted	<u>\$ (25.92)</u>	<u>\$ (28.96)</u>	<u>\$ (25.73)</u>
Shares used in computing net loss per share attributable to common stockholders, basic and diluted	<u>653</u>	<u>752</u>	<u>1,255</u>
Pro forma net loss per share attributable to common stockholders, basic and diluted (unaudited)			<u>\$ (1.26)</u>
Pro forma shares used in computing pro forma net loss per share attributable to common stockholders, basic and diluted (unaudited)			<u>27,657</u>

See notes to consolidated financial statements.

ENPHASE ENERGY, INC.
Consolidated Statements of Stockholders' Equity
(in thousands, except per share data)

	Convertible Preferred Stock										Common Stock		Additional Paid-In Capital	Accumulated Deficit	Accumulated Other Comprehensive Income	Total Stockholders' Equity	Comprehensive Loss	
	Series A		Series B		Series C		Series D		Series E									
	Shares	Amount	Shares	Amount	Shares	Amount	Shares	Amount	Shares	Amount	Shares	Amount						
BALANCE — December 31, 2008	207	\$ 584	1,065	\$ 6,375	1,286	\$ 14,912	—	\$ —	—	\$ —	695	\$ —	\$ 298	\$(17,816)	\$ —	\$ 4,353		
Issuance of Series D convertible preferred stock at \$2.13 per share, net of issuance costs of \$114							11,401	24,214								24,214		
Issuance of Series D convertible preferred stock and beneficial conversion feature upon conversion of promissory notes							831	1,774									1,774	
Exercise of stock options											37		31				31	
Stock-based compensation													180				180	
Net loss and total comprehensive loss														(16,925)		(16,925)	\$ (16,925)	
BALANCE — December 31, 2009	207	584	1,065	6,375	1,286	14,912	12,232	25,988	—	—	732	—	509	(34,741)	—	13,627		
Issuance of Series E convertible preferred stock at \$6.17 per share, net of issuance costs of \$145									7,431	45,737							45,737	
Exercise of stock options											111		65				65	
Stock-based compensation													829				829	
Net loss and total comprehensive loss														(21,777)		(21,777)	\$ (21,777)	
BALANCE — December 31, 2010	207	584	1,065	6,375	1,286	14,912	12,232	25,988	7,431	45,737	843	—	1,403	(56,518)	—	38,481		
Issuance of common stock at \$5.27 per share											353		1,858				1,858	
Exercise of stock options											502		190				190	
Stock-based compensation													2,120				2,120	
Fair value of warrants and common stock issued in connection with convertible notes														2,312			2,312	
Fair value of beneficial conversion feature upon issuance of convertible notes														1,165			1,165	
Fair value of beneficial conversion feature from accrued paid in kind interest of convertible notes														55			55	
Net loss														(32,290)		(32,290)	\$ (32,290)	
Other comprehensive income:																		
Cumulative translation adjustment																83	83	83
Total comprehensive loss																		\$ (32,207)
BALANCE — December 31, 2011	207	\$ 584	1,065	\$ 6,375	1,286	\$ 14,912	12,232	\$ 25,988	7,431	\$ 45,737	1,698	\$ —	\$ 9,103	\$(88,808)	\$ 83	\$ 13,974		

See notes to consolidated financial statements.

ENPHASE ENERGY, INC.
Consolidated Statements of Cash Flows
(in thousands)

	Year Ended December 31,		
	2009	2010	2011
Cash flows from operating activities:			
Net loss	\$(16,925)	\$(21,777)	\$(32,290)
Adjustments to reconcile net loss to net cash used in operating activities:			
Depreciation and amortization	803	1,550	3,032
Net loss on disposal of assets	—	24	—
Provision for doubtful accounts	50	—	127
Noncash interest expense	274	90	1,835
Stock-based compensation	180	829	2,120
Change in fair value of convertible preferred stock warrants	—	189	321
Changes in operating assets and liabilities:			
Accounts receivable	(5,691)	(1,655)	(9,874)
Inventory	(700)	(3,038)	(6,708)
Prepaid expenses and other assets	(71)	(298)	(1,648)
Accounts payable, accrued and other liabilities	3,085	4,877	17,275
Deferred revenues	108	1,357	25,443
Net cash used in operating activities	<u>(18,887)</u>	<u>(17,852)</u>	<u>(367)</u>
Cash flows from investing activities:			
Purchases of property and equipment	(2,134)	(3,262)	(14,662)
Purchases of intangible assets	(36)	—	—
Deposits	(55)	—	—
Restricted cash	103	—	—
Net cash used in investing activities	<u>(2,122)</u>	<u>(3,262)</u>	<u>(14,662)</u>
Cash flows from financing activities:			
Proceeds from issuance of convertible preferred stock	24,328	45,882	—
Costs related to issuance of convertible preferred stock	(114)	(145)	—
Proceeds from issuance of convertible notes	1,500	—	20,000
Costs related to issuance of convertible notes	—	—	(274)
Proceeds from sale of common stock	—	—	1,858
Principal payments under capital leases	(70)	(65)	(169)
Proceeds from term loans and debt	—	7,000	9,898
Debt issuance costs	—	(90)	(573)
Repayments of term loans	(160)	(178)	(1,863)
Proceeds from the exercise of stock options	31	61	190
Deferred offering costs	—	—	(2,585)
Net cash provided by financing activities	<u>25,515</u>	<u>52,465</u>	<u>26,482</u>
Effect of exchange rate changes on cash	—	—	78
Net increase in cash and cash equivalents	4,506	31,351	11,531
Cash and cash equivalents — Beginning of period	4,136	8,642	39,993
Cash and cash equivalents — End of period	<u>\$ 8,642</u>	<u>\$ 39,993</u>	<u>\$ 51,524</u>
Supplemental disclosures of cash flow information:			
Cash paid for interest	<u>\$ 82</u>	<u>\$ 695</u>	<u>\$ 1,235</u>
Noncash financing and investing activities:			
Assets acquired under capital lease	<u>\$ —</u>	<u>\$ —</u>	<u>\$ 295</u>
Purchases of property and equipment included in accounts payable	<u>\$ —</u>	<u>\$ 521</u>	<u>\$ 903</u>
Conversion of promissory note to Series D preferred stock	<u>\$ 1,500</u>	<u>\$ —</u>	<u>\$ —</u>
Deferred offering costs not yet paid	<u>\$ —</u>	<u>\$ —</u>	<u>\$ 371</u>

See notes to consolidated financial statements.

ENPHASE ENERGY, INC.
NOTES TO CONSOLIDATED FINANCIAL STATEMENTS
YEARS ENDED DECEMBER 31, 2009, 2010 AND 2011

1. ORGANIZATION AND DESCRIPTION OF BUSINESS

Enphase Energy, Inc. and subsidiaries (the “Company”) designs, develops, and sells microinverter systems for the solar photovoltaic industry. The Company was incorporated in 2006 and began selling its products in June 2008. The Company’s microinverter system consists of (i) an Enphase microinverter that attaches to the racking beneath solar modules and converts direct current (DC) power to grid-compliant alternating current (AC) power; (ii) an Envoy communications gateway device that collects and transmits performance information from each solar module to the Company’s hosted data center; and (iii) the Enlighten web-based software platform that collects and processes this information to enable customers to monitor and manage their solar power systems. The Company sells microinverter systems primarily to distributors who resell them to solar installers. The Company also sells directly to large installers as well as through original equipment manufacturers (“OEMs”) and strategic partners.

2. SUMMARY OF SIGNIFICANT ACCOUNTING POLICIES

Principles of Consolidation—The accompanying consolidated financial statements include the accounts of the Company and its wholly owned subsidiaries. All intercompany balances and transactions have been eliminated in consolidation.

Unaudited Pro Forma Consolidated Balance Sheet—Upon the consummation of the initial public offering contemplated by the Company, (i) all of the outstanding shares of convertible preferred stock will automatically convert into shares of common stock, (ii) the outstanding principal amount and paid-in-kind interest under our Convertible Facility will automatically convert into shares of common stock, and, (iii) all of the outstanding warrants to purchase convertible preferred stock will automatically convert into warrants to purchase common stock. The December 31, 2011 unaudited pro forma consolidated balance sheet data has been prepared assuming the (i) conversion of the convertible preferred stock outstanding into 25,170,918 shares of common stock, (ii) reclassification of the convertible preferred stock warrants from liabilities to stockholders’ equity, (iii) conversion of the outstanding principal amount and paid-in-kind interest under our Convertible Facility into 3,186,644 shares of common stock (at an assumed offering price of \$6.50 per share, which is the midpoint of the price range set forth on the cover of this prospectus), and (iv) write-off of debt issuance costs and debt discount of \$2,994,000 to accumulated deficit, as a result of the closing of this offering.

Use of Estimates—The preparation of the Company’s consolidated financial statements in conformity with accounting principles generally accepted in the United States of America requires management to make estimates and assumptions that affect the reported amounts of assets and liabilities, disclosure of contingent assets and liabilities at the date of the financial statements and the reported amounts of income and expenses during the reporting period. These estimates are based on information available as of the date of the financial statements; therefore, actual results could differ materially from management’s estimates using different assumptions or under different conditions.

Risks and Uncertainties—The Company is subject to the risks inherent in a business with a limited operating history, including, but not limited to, new and rapidly evolving markets, reliance on additional equity or debt issuances at appropriate terms for funding of operations, advances and trends in the development of new technology and services, unfavorable economic and market conditions, competition from larger and more established companies, limited management resources and dependence on a limited number of contract manufacturers and suppliers. Failure by the Company to anticipate or to respond adequately to technological developments in its industry, changes in customer or supplier requirements, or changes in regulatory requirements or industry standards, could have a material adverse effect on the Company’s business and operating results.

[Table of Contents](#)

Revenue Recognition—The Company generates revenue from sales of its microinverter systems, which include microinverter units, an Envoy communications gateway device, and an Enlighten web-based monitoring service, to distributors, large installers, OEMs and strategic partners. Enlighten service revenue represented less than 1% of the total revenues for all periods presented.

Revenues from the sales of microinverters and communication gateways are recognized when: (i) persuasive evidence of an arrangement exists; (ii) delivery of the products has occurred in accordance with the terms of the sales agreement and title of and risk of loss have passed to the customer; (iii) the sale price is fixed or determinable; and (iv) collection is reasonably assured. Provisions for rebates, sales incentives, and discounts to customers are accounted for as reductions in revenue in the same period the related sales are recorded. Revenues from web-based monitoring services are recognized ratably over the estimated service period of 10 years.

Deferred revenues consist of payments received from customers in advance of revenue recognition for the Company's products and services described above. The Company recognizes revenue when all revenue recognition criteria are met (see also Note 16).

Cost of Revenues—The Company includes the following in cost of revenues: product costs consisting of purchases from contract manufacturers and other suppliers, warranty, personnel and logistics costs, hosting services costs related to the Company's Enlighten service offering, and depreciation and amortization of test equipment.

Fair Value of Financial Instruments—The carrying amounts of cash and cash equivalents, accounts receivable and accounts payable approximate fair value due to their relatively short-term nature. The carrying amount of the Company's term loans approximates its fair value. The fair value of the Company's convertible notes is estimated based on a valuation model that incorporates relevant Level 3 market inputs. As of December 31, 2011, the estimated fair value of the Company's convertible notes was \$21.7 million.

Fair Value Measurements—The accounting guidance defines fair value as the price that would be received from selling an asset or paid to transfer a liability in an orderly transaction between market participants at the measurement date. When determining the fair value measurements for assets and liabilities required to be recorded at fair value, the Company considers the principal or most advantageous market in which it would transact and considers assumptions that market participants would use when pricing the asset or liability, such as inherent risk, transfer restrictions, and risk of nonperformance.

The fair value hierarchy requires an entity to maximize the use of observable inputs and minimize the use of unobservable inputs when measuring fair value. An asset's or liability's categorization within the fair value hierarchy is based upon the lowest level of input that is significant to the fair value measurement. Three levels of inputs may be used to measure fair value:

- *Level 1* — Valuations based on quoted prices in active markets for identical assets or liabilities that the Company has the ability to access. Since valuations are based on quoted prices that are readily and regularly available in an active market, valuation of such assets or liabilities do not entail a significant degree of judgment.
- *Level 2* — Valuations based on one or more quoted prices in markets that are not active or for which all significant inputs are observable, either directly or indirectly.
- *Level 3* — Valuations based on inputs that are unobservable and significant to the overall fair value measurement.

On a recurring basis, the Company measures its convertible preferred stock warrant liabilities at fair value based on Level 3 inputs, which requires a higher degree of judgment (see Note 10).

Cash and Cash Equivalents—The Company considers all highly liquid investments, such as certificates of deposit and money market instruments with maturities of six months or less at the time of acquisition to be cash equivalents. For all periods presented, the Company's cash balances consist of amounts held in interest-bearing money market accounts.

[Table of Contents](#)

Allowances for Doubtful Accounts—The Company maintains allowances for doubtful accounts for uncollectible accounts receivable. The Company estimates anticipated losses from doubtful accounts based on days past due, collection history and other factors. The allowance for doubtful accounts was \$16,000 and \$144,000 at December 31, 2010 and 2011, respectively.

Inventory—Inventory is valued at the lower of cost or market. The Company determines cost on a first-in first-out basis. Certain factors could affect the realizable value of its inventory, including customer demand and market conditions. The Company considers historical usage, expected demand, anticipated sales price, effect of new product introductions, product obsolescence, customer concentrations, product merchantability and other factors when evaluating the value of inventory. Inventory write-downs are equal to the difference between the cost of inventories and their estimated fair market value. Inventory write-downs are recorded as cost of revenues in the accompanying consolidated statements of operations and were \$50,000, \$0.1 million and \$2.7 million in 2009, 2010 and 2011, respectively.

Property and Equipment—Property and equipment are stated at cost less accumulated depreciation. Cost includes the price paid to acquire or construct the asset as well as any expenditure that substantially adds to the value of or significantly extends the useful life of an existing asset. Repair and maintenance costs are expensed as incurred. Depreciation and amortization is computed using the straight-line method over the estimated useful lives of the assets, which range from three to five years. Leasehold improvements are amortized over the shorter of the lease term or expected useful life of the improvements.

Capitalized Software Costs—Costs related to internal-use software are capitalized when preliminary development efforts are successfully completed, management has authorized and committed project funding, and it is probable that the project will be completed and the software will be used as intended. Such costs are amortized on a straight-line basis over their estimated useful lives. Costs incurred prior to meeting these criteria, together with costs incurred for training and maintenance, are expensed as incurred.

Indefinite-Lived Intangible Assets—Indefinite-lived intangible assets included in other assets were \$266,000 at December 31, 2010 and \$286,000 at December 31, 2011. Such intangible assets consist of acquired intellectual property rights that currently have been determined to have indefinite lives and therefore are not amortized. The carrying values are assessed at least annually for impairment, or more frequently if events or changes in circumstances indicate that the carrying amount of such assets may not be recoverable.

Long-Lived Assets—The Company evaluates its long-lived assets for impairment whenever events or changes in circumstances indicate that the carrying amount of such assets may not be recoverable. Recoverability of assets to be held and used is measured by a comparison of the carrying amount of an asset to future undiscounted net cash flows expected to be generated by the asset. If such assets are considered to be impaired, the impairment to be recognized is measured by the amount by which the carrying amount of the assets exceeds the fair value of the assets.

Warranty Obligations—The Company's microinverters include a 15-year or 25-year warranty. The Company maintains reserves to cover the expected costs that could result from these warranties. The potential liability is generally in the form of product replacement. Warranty reserves are computed on a per unit sold basis and are based on the Company's best estimate of such costs and are included in cost of revenues. The reserve for the related warranty expenses is based on various factors including historical warranty claims, assumptions about the frequency of warranty claims, and assumptions about the frequency of product failures, derived from results of accelerated lab testing, field monitoring and the Company's reliability estimates. The Company's estimated costs of warranty for previously sold products may change to the extent future products are not compatible with earlier generation products under warranty.

Product failure rates are estimated primarily by using field monitoring of the actual failure rates of the microinverters the Company has sold to date. The Company has established estimated reliability based on the

[Table of Contents](#)

units' estimated mean time between failure (MTBF), a metric that equates to a steady-state failure rate of approximately 0.3% per year for current generation products. The MTBF represents the predicted mean elapsed time to microinverter unit failure during system operation. In addition, due to the Company's limited operating history, it also utilizes third party data collected on similar equipment deployed in outdoor environments similar to those in which its microinverters are installed, as well as accelerated life cycle testing, which simulates the service life of the product in a short period of time. The accelerated life cycle tests incorporate test methodologies derived from standard tests used by solar module vendors to evaluate the period over which solar modules wear out. Predicted failure rates are updated periodically based on field return data. Corresponding replacement costs are updated periodically to reflect changes in the actual and estimated production costs for the Company's microinverters. Furthermore, changes to the warranty provision as a percentage of microinverter units sold will vary based on the replacement cost of the specific generation of microinverter unit under warranty. In addition, different generations of microinverters may have different warranty terms which further contribute to changes in the warranty provision as a percentage of microinverter units sold. For example, the Company's first and second generation microinverters have a 15-year warranty while the Company's third generation microinverter has a 25-year warranty.

In addition, the Company supports its microinverters with its Entrust program. The Company reimburses the system owner for any lost energy for up to one month if a microinverter unit should fail, which is referred to as a "100% uptime guarantee." The Company estimates that its microinverter systems achieve system uptimes of over 99.8%. Historically, disbursements under the Entrust program have been insignificant, and therefore no accruals have been recorded for any such future obligations.

Research and Development Costs—The Company expenses research and development costs as incurred.

Stock-Based Compensation—Share-based payments are required to be recognized in the Company's consolidated statements of operations based on their fair values and the estimated number of shares expected to vest. The Company measures stock-based compensation expense for all share-based payment awards, including stock options made to employees and directors, based on the estimated fair values on the date of the grant. The fair value of each stock option granted is estimated using the Black-Scholes option valuation model. Stock-based compensation, net of estimated forfeitures, is recognized on a straight-line basis over the requisite service period, which is typically four years.

Comprehensive Loss—Total comprehensive loss and the components of accumulated other comprehensive income are presented in the consolidated statements of stockholders' equity. Accumulated other comprehensive income consists of foreign currency translation effects.

Convertible Preferred Stock Warrants—The Company records its freestanding warrants to purchase its convertible preferred stock as liabilities at their fair value upon issuance by utilizing a Monte Carlo simulation model that takes into account estimated probabilities of possible outcomes. The fair value of the warrants is subject to remeasurement at each balance sheet date with any change in value being reflected as other income (expense), net. Upon the earlier of the exercise of the warrants or the completion of a liquidation event, including the completion of an initial public offering, the liability will be reclassified to stockholders' equity, at which time it will no longer be subject to fair value accounting.

Income Taxes—The Company records income taxes using the asset and liability method, which requires the recognition of deferred tax assets and liabilities for the expected tax consequences of temporary differences between the tax bases of assets and liabilities for financial reporting purposes and amounts recognized for income tax purposes. In estimating future tax consequences, generally all expected future events other than enactments or changes in the tax law or rates are considered. Valuation allowances are provided when necessary to reduce deferred tax assets to the amount expected to be realized.

The Company operates in various tax jurisdictions and is subject to audit by various tax authorities. The Company follows accounting for uncertainty in income taxes which requires that the tax effects of a position be

[Table of Contents](#)

recognized only if it is “more likely than not” to be sustained based solely on its technical merits as of the reporting date. The Company considers many factors when evaluating and estimating its tax positions and tax benefits, which may require periodic adjustments and which may not accurately anticipate actual outcomes.

Deferred Offering Costs—Deferred offering costs consisted primarily of accounting and legal fees related to the Company’s proposed initial public offering of its common stock. Approximately \$3.0 million of deferred offering costs is included in other assets on the Company’s consolidated balance sheet as of December 31, 2011. Upon completion of the initial public offering contemplated herein, these amounts will be offset against the proceeds of the offering. If the offering is terminated, the deferred offering costs will be expensed.

Debt Issuance Costs—Debt issuance costs are included in other assets and are amortized over the life of the respective debt facility.

3. INVENTORY

Inventory as of December 31, 2010 and 2011, consists of the following (in thousands):

	December 31,	
	2010	2011
Raw materials	\$ 761	\$ 1,848
Finished goods	3,760	9,380
Total inventory	<u>\$4,521</u>	<u>\$ 11,228</u>

4. PROPERTY AND EQUIPMENT, NET

As of December 31, 2010 and 2011, property and equipment, net consists of the following (in thousands):

	Estimated Useful Life (Years)	December 31,	
		2010	2011
Equipment and machinery	5	\$ 4,777	\$ 11,243
Furniture and fixtures	3–5	530	990
Computer equipment	3	721	1,200
Capitalized software	3	1,709	2,515
Leasehold improvements	Shorter of lease term or useful life	483	694
Construction in progress		590	7,499
Total		8,810	24,141
Less accumulated depreciation and amortization		(2,707)	(5,730)
Property and equipment, net		<u>\$ 6,103</u>	<u>\$ 18,411</u>

Depreciation and amortization was \$0.8 million, \$1.6 million and \$3.0 million in 2009, 2010 and 2011, respectively.

Included in property and equipment are assets acquired under capital lease obligations with an original cost of \$223,000 and \$199,000 and \$494,000 as of December 31, 2009, 2010 and 2011, respectively. Accumulated amortization was \$95,000, \$149,000 and \$180,000 as of December 31, 2009, 2010 and 2011, respectively.

Capitalized Internal Use Software—The Company capitalized \$237,000, \$815,000 and \$806,000 internal use software costs for the years ended December 31, 2009, 2010 and 2011, respectively. The capitalized software costs are being amortized ratably over the estimated useful lives and are included within amortization expense in the amount of \$165,000, \$423,000 and \$654,000 for fiscal 2009, 2010 and 2011, respectively.

5. WARRANTY OBLIGATIONS

Changes in the Company's product warranty liability in 2010 and 2011 were as follows (in thousands):

	December 31,	
	2010	2011
Balance, at beginning of year	\$ 1,087	\$ 2,668
Warranty expense	1,896	7,030
Settlements and other reductions	(315)	(960)
Balance, at end of year	2,668	8,738
Less current portion	(340)	(2,005)
Long-term portion	<u>\$ 2,328</u>	<u>\$ 6,733</u>

Warranty expense in 2011 includes changes in estimates of \$(443,000) to reflect reduced expected replacement costs to fulfill certain warranty obligations and \$905,000 to reflect increased estimated replacement costs for certain products.

6. LONG-TERM DEBT

The Company's long-term debt was comprised of the following at December 31, 2010 and 2011 (in thousands):

	December 31,	
	2010	2011
Term loans, net of unamortized discount of \$330 and \$435, respectively	\$ 6,903	\$ 9,935
Equipment financing facility, net of unamortized discount \$156	—	4,742
Total debt	6,903	14,677
Less current portion	(2,567)	(4,529)
Long-term portion	<u>\$ 4,336</u>	<u>\$ 10,148</u>

As of December 31, 2011, the amount of future principal repayments due on the total debt is as follows (in thousands):

2012	\$ 5,095
2013	6,722
2014	3,003
2015	448
Total	<u>\$ 15,268</u>

Term Loans—On March 11, 2010, the Company entered into a venture loan agreement pursuant to which the Company borrowed \$7.0 million ("Original Term Loan") to be used for general business purposes. The loan has an interest rate of 12.6% and a 42-month term, maturing on October 1, 2013. Monthly payments for the first 12 months were interest only. Monthly payments beginning the thirteenth month will include interest and principal based on a 30-month remaining amortization period. The loan provides for penalties for early repayment, is secured by all assets of the Company except intellectual property and prohibits any dividend payments. As part of the agreement, the Company issued a warrant to purchase the Company's Series E convertible preferred stock. The fair value of the warrant of \$421,000 was recorded as a liability and a debt discount and is being amortized to interest expense over the loan term, or 42 months (see Note 10). As of December 31, 2011, the Original Term Loan had an outstanding principal balance of \$5.3 million.

[Table of Contents](#)

On March 25, 2011, the Company entered into an amendment to the Original Term Loan to provide for an additional \$2.0 million term loan, which was fully drawn upon at execution of the amendment, and an additional \$3.0 million term loan available to be drawn upon through September 30, 2011 (the “Additional Term Loans”), both of which will mature on the first calendar day of the month that follows the 42-month anniversary of the date of advance. On September 22, 2011, the Company drew \$3.0 million under this term loan. As of December 31, 2011, the \$2.0 million outstanding principal balance will mature on October 1, 2014 and the remaining \$3.0 million outstanding principal balance will mature on April 1, 2015.

The Additional Term Loans have an interest rate of 10.75% and all borrowings have a 42-month term. Monthly payments for the first 12 months are interest only; subsequent monthly payments include interest and principal, based on a 30-month remaining amortization period. The other terms and conditions of the Original Term Loan remain substantially unchanged.

In connection with Additional Term Loans, the Company issued a warrant to purchase 48,587 shares of the Company’s Series E convertible preferred stock at an exercise price of approximately \$6.17 per share. The warrant is exercisable until the later of (i) 10 years, or (ii) five years after an initial public offering.

The fair value of the warrant of \$286,000 at issuance was recorded as a liability and a debt discount and is being amortized to interest expense over the loan term, or 42 months (see Note 10).

Equipment Financing Facility—On June 13, 2011, the Company entered into a \$5.0 million equipment financing facility with Hercules Technology Growth Capital, Inc. The equipment financing facility has a variable interest rate set at the higher of 5.75% above the prime lending rate and 9.0% annually and expires July 1, 2014. This facility is secured by the financed equipment and restricts the Company’s ability to pay dividends and take on certain types of additional liens. In connection with this facility, the Company issued warrants to purchase Series E convertible preferred stock (see Note 10). As of December 31, 2011, outstanding borrowings under the equipment financing facility were \$4.9 million.

Revolving Line of Credit Facility—On January 19, 2010, the Company entered into a revolving line of credit agreement that provides for up to \$10.0 million in borrowings, based on a percentage of eligible receivables. The line of credit has a variable interest rate set at 1% above the bank’s prime lending rate and expires January 19, 2012, with interest payable monthly and principal due at maturity. The loan is secured by all of the Company’s assets except intellectual property.

On March 24, 2011, the Company amended the revolving line of credit facility to provide for an increase from \$10.0 million to a maximum of \$25.0 million revolving credit facility, including a \$5.0 million letter of credit subfacility, and extended the term of the credit commitments to March 24, 2013. Pursuant to a second amendment of the revolving line of credit agreement dated December 30, 2011, the Company increased its revolving line of credit from \$25.0 million to \$33.0 million, including an increase of the letter of credit subfacility to \$10.0 million, and further extended the availability of the facility until December 30, 2013. Available borrowings are based on 80% of eligible receivables and 50% of inventory (up to \$13.2 million). The line of credit has a variable interest rate set at 1.25% above the bank’s prime lending rate, with interest payable monthly and principal due on December 30, 2013. Any advance is collateralized by the underlying receivable or inventory and secured by all of the Company’s assets except intellectual property. The agreement requires the Company to maintain minimum asset coverage and tangible net worth requirements. As of December 31, 2011, the Company had not drawn any amounts under the facility.

Convertible Promissory Notes—On June 30, 2009, the Company borrowed a total of \$1.5 million under five secured convertible promissory notes with several of its key investors. The notes carried an interest rate of 8% per year and were due and payable by December 31, 2009. On April 24, 2009, the notes, and accrued interest of \$8,000, were converted into 831,375 shares of Series D convertible preferred stock, representing a discount of

[Table of Contents](#)

approximately 15% to such investors (see Note 10). The resulting beneficial conversion feature of \$266,000 and the related accrued interest of \$8,000 were charged to interest expense.

Line of Credit Agreement—In December 2008, the Company entered into a \$1.0 million line of credit, which expired on January 1, 2012. Amounts drawn under the line of credit are payable over 36 months with an annual interest at a rate of approximately 14%. Specific assets were pledged as collateral for any amounts drawn under the line of credit. Any amounts drawn under the line of credit were subject to penalties for early repayment. The line of credit agreement does not include financial covenants or other material covenant requirements. As of December 31, 2010 and 2011, the line of credit had an outstanding principal balance of \$233,000 and \$28,000, respectively, which was repaid in January 2012.

7. CONVERTIBLE FACILITY

In June 2011, the Company entered into a junior secured convertible loan facility with certain existing preferred stockholders that provided for up to \$50.0 million in borrowings (“Convertible Facility”). The Company borrowed \$12.5 million upon signing. In November 2011, the Company amended the Convertible Facility to provide for an aggregate of up to \$80.0 million in borrowings. The Company borrowed an additional \$7.5 million in November 2011 and may borrow up to an additional \$60.0 million prior to the earlier of (i) a subsequent equity financing of more than \$10.0 million or (ii) June 14, 2013, subject to the attainment of certain financial and operating conditions. The Convertible Facility bears interest at a rate of 9.0%, with interest payable in-kind at maturity which is the earlier to occur of the closing of (i) the initial public offering, (ii) a change in control or (iii) June 14, 2014. The initial and second advances totaling \$20.0 million (“Convertible Notes”), together with any accrued interest are convertible into common stock at a conversion price of \$8.8984 per share, subject to adjustments. Additional borrowings and accrued interest are repayable at the holders’ option as follows: up to 50% convertible into common stock at a price of \$8.8984 per share and the remainder in cash. In addition, the Company may prepay, at its election, up to 50% of any additional borrowings and related accrued interest at any time. The Convertible Facility is secured by all of the assets of the Company except intellectual property, prohibits dividend payments and restricts prepayment of the convertible portion of any outstanding loans under the facility. The agreement also requires the Company to meet certain minimum gross profit metrics and maximum warranty claim rates in order to be eligible for further advances under the facility.

In connection with initial signing of the Convertible Facility and the initial \$12.5 million borrowing in June 2011, the Company (i) issued 208,209 shares of common stock at \$5.27 per share and received proceeds of \$1.1 million, and (ii) issued warrants to purchase 76,601 shares of the Company’s common stock at \$5.27 per share that are immediately exercisable and have a contractual term of 5 years from the date of issuance. The Company recorded the initial \$12.5 million face amount of the convertible notes, the common stock and the warrants at their fair values of \$12.1 million, \$1.9 million and \$0.5 million, respectively. In addition, the Company recorded a \$0.4 million reduction in the carrying value of the convertible notes with an offsetting entry to additional paid-in capital to recognize a beneficial conversion feature (BCF) embedded in the convertible notes. The BCF represents the difference between the effective conversion price and the estimated fair value of the common stock on the commitment date multiplied by the number of common shares into which the notes are convertible.

The difference between the total fair value of the convertible notes, common stock and warrants of \$14.5 million and the cash proceeds received of \$13.6 million was treated as a debt issuance cost representing consideration for availability under the initial \$50.0 million Convertible Facility and will be amortized over the life of the Convertible Facility.

In connection with the amendment to the Convertible Facility completed in November 2011, which increased total borrowing capacity under the Convertible Facility by \$30.0 million, the Company issued (i) 144,456 shares of common stock at \$5.27 per share and received proceeds of \$0.8 million and (ii) warrants to purchase 54,915 shares of the Company’s common stock at \$5.27 per share with the same terms as the warrants issued in June 2011. The common stock and warrants were recorded at their fair values of \$1.4 million and \$0.4

[Table of Contents](#)

million, respectively. The \$7.5 million in convertible notes issued in November 2011 were recorded at their face amount less a \$0.8 million reduction in the carrying value of the convertible notes with an offsetting entry to additional paid-in capital to recognize a BCF embedded in the convertible notes.

The difference between the total fair value of the common stock and warrants of \$1.8 million and the cash proceeds received of \$0.8 million was treated as a debt issuance cost representing consideration for the incremental \$30.0 million of borrowing capacity available pursuant to the amendment and will be amortized over the remaining life of the Convertible Facility.

8. DEFINED CONTRIBUTION PLAN

The Company sponsors a defined contribution 401(k) savings plan covering substantially all of its U.S. employees, subject to certain eligibility requirements. Annually, the Company contributes 3% of an employee's salary earned in that given year, excluding commissions and bonuses, to the plan, regardless of whether the employee contributes. Any contributions made by the Company vest immediately to the participant. Costs related to the plan recognized by the Company for the years ended December 31, 2009, 2010 and 2011 was \$0.2 million, \$0.4 million, and \$0.7 million, respectively.

9. COMMITMENTS AND CONTINGENCIES

Operating Leases—The Company leases office facilities under noncancelable operating leases that expire on various dates through 2022. The terms of the lease agreements generally provide for rental payments on a graduated basis, and certain leases require the Company to pay its portion of executory costs such as taxes, insurance, and operating expenses. The Company recognizes rent expense on a straight-line basis over the lease term.

Rent expense for the years ended December 31, 2009, 2010 and 2011 was \$0.3 million, \$0.6 million and \$1.2 million, respectively.

The Company's minimum lease payments under noncancelable operating leases, exclusive of executory costs, as of December 31, 2011 are as follows (in thousands):

2012	\$ 1,457
2013	1,430
2014	1,519
2015	1,606
2016	1,484
Thereafter	7,536
Total minimum lease payments	<u>\$15,032</u>

On June 3, 2011, the Company entered into an agreement to lease approximately 96,000 square feet of office space for its new corporate headquarters. The expiration of the current corporate headquarters' lease coincides with the Company's move to the new corporate headquarters in early 2012. The Company expects the total costs of the tenant build-out for the new corporate headquarters to be approximately \$8.7 million, of which \$3.8 million will be paid for by the landlord. The costs related to landlord incentives will be capitalized as leasehold improvement assets and a deferred liability at the time the Company takes possession of the premises, which is expected to be in the first quarter of 2012. The capitalized leasehold improvement assets will be subject to depreciation and the deferred liability will be amortized over the term of the lease as a reduction of rent expense.

Subsequent to year end, the Company entered into an additional facility lease for ten years having minimum lease payments totaling approximately \$1.7 million.

Purchase Obligations—The Company has contractual obligations to purchase goods and services, which specify fixed or minimum quantities to be purchased; fixed, minimum, or variable price provisions; and the approximate timing of the transaction. Purchase obligations do not include contracts that may be canceled without penalty.

The Company utilizes third parties to manufacture its products. It acquires raw materials or other goods and services, including product components, by issuing to suppliers authorizations to purchase based on its projected demand and manufacturing needs.

As of December 31, 2011, the Company had noncancelable purchase obligations totaling approximately \$138 million.

Contingencies—From time to time, the Company may become involved in litigation. Management is not currently aware of any litigation matters or other contingencies that could have a material adverse effect on the financial position, results of operations, or cash flows of the Company.

10. STOCKHOLDERS' EQUITY AND WARRANTS

Series A, B, C, D and E Convertible Preferred Stock

Series A—In June 2006, the Company issued 206,492 shares of Series A convertible preferred stock at approximately \$2.91 per share. The Company received proceeds of \$584,000, net of \$16,000 in issuance costs.

Series B—In February and March 2007, the Company issued 940,557 shares of Series B convertible preferred stock at approximately \$6.02 per share. The Company received proceeds of \$5,625,000, net of \$33,000 in issuance costs. In January 2008, the Company issued an additional 124,677 shares of Series B convertible preferred stock at approximately \$6.02 per share. The Company received proceeds of \$750,000. Primary investors in the Series B convertible preferred stock have the right to elect a member to the Company's Board of Directors.

Series C—In April 2008, the Company issued 1,285,890 shares of Series C convertible preferred stock at approximately \$11.67 per share. The Company received proceeds of \$14,912,000, net of \$88,000 in issuance costs. Primary investors in the Series C convertible preferred stock have the right to elect a member to the Company's Board of Directors.

Series D—In April and June 2009, the Company issued 11,401,122 shares of Series D convertible preferred stock at approximately \$2.13 per share. The Company received proceeds of \$24,214,000, net of \$114,000 in issuance costs. Primary investors in the Series D preferred stock have the right to elect a member to the Company's Board of Directors. In April 2009, the Company issued 831,373 shares of Series D convertible preferred stock upon conversion of \$1,508,000 in principal and accrued interest under convertible promissory notes (see Note 6).

Series E—In March, April and May 2010, the Company authorized 8,259,912 shares and issued 7,430,745 shares of Series E convertible preferred stock at approximately \$6.17 per share. The Company received proceeds of \$45,737,000, net of \$145,000 in issuance costs. Primary investors in the Series E convertible preferred stock have the right to elect two members to the Company's Board of Directors. On April 5, 2010, as part of the issuance of Series E convertible preferred stock, the Company's primary inventory manufacturer and supplier purchased 809,795 shares of the Company's Series E convertible preferred stock at approximately \$6.17 per share or \$5 million in total. This represents an ownership interest in the Company of approximately 3% as of December 31, 2011.

Voting—The holders of Series A, B, C, D and E convertible preferred stock are entitled to the number of votes equal to the number of shares of common stock into which the preferred stock is convertible, subject to certain limitations.

Table of Contents

Dividends—Subject to the prior dividend rights of the Series E, D, C, and B convertible preferred stock, the holders of the Series A convertible preferred stock are entitled to receive, if, when and as declared by the Board of Directors, cash dividends at the rate of approximately \$0.23 per share per annum (as adjusted for any stock splits, stock dividends, combinations or reorganizations). Such dividends are not mandatory or cumulative.

Subject to the prior dividend rights of the Series E, D, and C convertible preferred stock, the holders of the Series B convertible preferred stock are entitled to receive, if, when and as declared by the Board of Directors, cash dividends at the rate of approximately \$0.48 per share per annum (as adjusted for any stock splits, stock dividends, combinations or reorganizations). Such dividends are not mandatory or cumulative.

Subject to the prior dividend rights of the Series E and D convertible preferred stock, the holders of the Series C convertible preferred stock are entitled to receive, if, when and as declared by the Board of Directors, cash dividends at the rate of approximately \$0.94 per share per annum (as adjusted for any stock splits, stock dividends, combinations or reorganizations). Such dividends are not mandatory or cumulative.

Subject to the prior dividend rights of the Series E convertible preferred stock, the holders of the Series D convertible preferred stock are entitled to receive, if, when and as declared by the Board of Directors, cash dividends at the rate of approximately \$0.17 per share per annum (as adjusted for any stock splits, stock dividends, combinations or reorganizations). Such dividends are not mandatory or cumulative.

The holders of the Series E convertible preferred stock are entitled to receive, if, when and as declared by the Board of Directors, cash dividends at the rate of approximately \$0.49 per share per annum (as adjusted for any stock splits, stock dividends, combinations or reorganizations). Such dividends are not mandatory or cumulative.

No dividends have been declared on the Series A, B, C, D or E convertible preferred stock.

Conversion—Each share of Series A, B, C, D and E convertible preferred stock is convertible at the option of the holder into the number of shares of common stock which results from dividing the original issue price for such series of convertible preferred stock by the conversion price for such series of convertible preferred stock.

The approximate conversion price of each series of convertible preferred stock is as follows, subject to certain adjustments:

Series A	\$2.37
Series B	3.17
Series C	4.64
Series D	2.13
Series E	6.17

The Series A, B, C, D and E convertible preferred stock will be automatically converted into common stock: (a) immediately prior to the closing of a firmly underwritten public offering pursuant to the Securities Act of 1933, if aggregate gross proceeds to the Company in such offering equal or exceed \$30,000,000 and the public offering price is not less than approximately \$6.17 per share (a “Qualified Public Offering”); and (b) upon receipt of the written consent of the holders of (i) 60% of the Series E convertible preferred stock voting as a separate series, with respect to the conversion of all outstanding shares of Series E convertible preferred stock, (ii) a majority of the Series E convertible preferred stock voting as a separate series in connection with an initial public offering that is not a Qualified Public Offering, or (iii) a majority of the holders of the Series A, B, C and D convertible preferred stock voting together on an as-converted basis with respect to the conversion of all outstanding shares of Series A, B, C and D convertible preferred stock.

Redemption—The Series A, B, C, D and E convertible preferred stock are not redeemable.

Liquidation Rights—In the event of any liquidation, dissolution, or winding-up of the Company, holders of Series E convertible preferred stock are entitled to receive an amount per share equal to the original issue price of

[Table of Contents](#)

the Series E convertible preferred stock plus all declared but unpaid dividends on the Series E convertible preferred stock, before any distributions of payments are made to the holders of any Series A, B, C, or D convertible preferred stock or common stock.

In the event of any liquidation, dissolution, or winding-up of the Company, and subject to payment in full of the liquidation preferences of the Series E convertible preferred stock, holders of Series D convertible preferred stock are entitled to receive an amount per share equal to two and one-half times the original issue price of the Series D convertible preferred stock plus all declared but unpaid dividends on the Series D convertible preferred stock, before any distributions of payments are made to the holders of any Series A, B, or C convertible preferred stock or common stock.

In the event of any liquidation, dissolution, or winding-up of the Company, and subject to payment in full of the liquidation preferences of the Series E and D convertible preferred stock, holders of Series C convertible preferred stock are entitled to receive an amount per share equal to the original issue price of the Series C convertible preferred stock plus all declared but unpaid dividends on the Series C convertible preferred stock, before any distributions of payments are made to the holders of any Series A or B convertible preferred stock or common stock.

In the event of any liquidation, dissolution, or winding-up of the Company, and subject to payment in full of the liquidation preferences of the Series E, D, and C convertible preferred stock, holders of Series B convertible preferred stock are entitled to receive an amount per share equal to the original issue price of the Series B convertible preferred stock plus all declared but unpaid dividends on the Series B convertible preferred stock, before any distributions of payments are made to the holders of any Series A convertible preferred stock or common stock.

In the event of any liquidation, dissolution, or winding-up of the Company, and subject to payment in full of the liquidation preferences of the Series E, D, C, and B convertible preferred stock, holders of Series A convertible preferred stock are entitled to receive an amount per share equal to the original issue price of the Series A convertible preferred stock plus all declared but unpaid dividends on the Series A convertible preferred stock, before any distributions of payments are made to the holders of any common stock.

The following table summarizes various terms of the different classes of convertible preferred stock and related warrants as of December 31, 2011 (in thousands, except per share data):

<u>Convertible Preferred Stock</u>	<u>Outstanding at December 31, 2011</u>	<u>Warrants Outstanding</u>	<u>Common Stock Equivalent Shares</u>	<u>Approximate Liquidation Preference per Share</u>	<u>Aggregate Liquidation Preference</u>	<u>Participating (per Share)</u>	<u>Approximate Annual Dividend per Share</u>
Series A	207		253	\$ 2.91	\$ 600	No	\$ 0.23
Series B	1,065		2,022	6.02	6,408	Yes	0.48
Series C	1,286	11	3,260	11.67	15,000	Yes	0.94
Series D	12,232		12,232	5.33	65,254	No	0.17
Series E	7,431	187	7,618	6.17	45,880	Yes	0.49
	<u>22,221</u>	<u>198</u>	<u>25,385</u>		<u>\$ 133,142</u>		

Warrant Transactions

Warrants to Purchase Convertible Preferred Stock

In September 2008, the Company entered into a strategic collaboration agreement with a third party, under which the third party would test and evaluate the Enphase microinverter for European certification. As part of the agreement, the third party was granted a warrant to purchase 11,013 shares of Series C convertible preferred stock at an approximate price of \$11.67 per share. Exercisability of the warrant is contingent upon completion of

[Table of Contents](#)

several milestones, none of which have been completed. The warrant terminates upon the earlier of (i) an initial public offering, (ii) a sale of the Company, or (iii) six months after it becomes exercisable. The Company concluded that the warrant will not ultimately vest, as the Company has not been actively working with the third party. Accordingly, no expense has been recorded in the accompanying consolidated financial statements.

In connection with the March 2010 financing transaction (see Note 6), the Company issued a warrant to purchase 113,371 shares of the Company's Series E convertible preferred stock at a price of \$6.174 per share. The warrant is immediately exercisable and expires at the later of (i) 10 years, or (ii) five years after an initial public offering and includes provisions for down-round and anti-dilution protection. The Company accounts for the freestanding warrant as a derivative financial instrument liability. Changes in fair value are recognized as either a gain or loss in the consolidated statement of operations within other income (expense), net. In the event of a liquidation event, including the completion of an initial public offering, the warrant, if not exercised, will be converted into a warrant to purchase common stock, and accordingly, the liability will no longer be subject to fair value remeasurement and the liability will be reclassified to stockholders' equity. The fair value of the warrant at issuance was \$421,000 (recorded as debt discount and amortized to interest expense over the loan term) and was calculated using the Monte Carlo simulation model with the following assumptions:

Expected term (in years)	6.0
Expected volatility	60.5%
Annual risk-free rate of return	2.6%
Dividend yield	0%

In connection with the March 25, 2011 Additional Term Loans (see Note 6), the Company issued a warrant to purchase 48,587 shares of the Company's Series E convertible preferred stock at an exercise price of \$6.174 per share. The warrant is immediately exercisable and expires at the later of (i) 10 years, or (ii) five years after an initial public offering and includes provisions for down-round and anti-dilution protection. The Company accounts for the freestanding warrant as a derivative financial instrument liability. Changes in fair value are recognized as either a gain or loss in the consolidated statement of operations within other income (expense). In the event of a liquidation event, including the completion of an initial public offering, the warrant, if not exercised, will be converted into a warrant to purchase common stock, and accordingly, the liability will no longer be subject to fair value remeasurement and the liability will be reclassified to stockholders' equity. The fair value of the warrant at issuance was \$286,000 (recorded as debt discount and amortized to interest expense over the loan term) and was calculated using the Monte Carlo simulation model with the following assumptions:

Expected term (in years)	4.7
Expected volatility	72.3%
Annual risk-free rate of return	2.1%
Dividend yield	0%

[Table of Contents](#)

In connection with the equipment financing facility, the Company issued warrants to purchase 25,285 shares of Series E convertible preferred stock at \$8.8984 per share. The warrant is immediately exercisable and expires at the later of (i) 10 years, or (ii) five years after an initial public offering and includes provisions for down-round and anti-dilution protection. The Company accounts for the freestanding warrant as a derivative financial instrument liability. Changes in the fair value of this preferred stock warrant liability are recognized in other income (expense), net. Upon the earlier of the exercise of the warrants or the completion of a liquidation event, including the completion of an initial public offering, the liability will be reclassified to stockholders' equity, at which time it will no longer be subject to fair value accounting. The fair value of the warrant at issuance was \$182,000 (recorded as deferred financing costs and is being amortized to interest expense over the term of any related borrowings) and was calculated using the Monte Carlo simulation model with the following assumptions:

Expected term (in years)	4.5
Expected volatility	73.0%
Annual risk-free rate of return	1.5%
Dividend yield	0%

The following table summarizes the changes in fair value of the Company's convertible preferred stock warrant liability, which is subject to fair value measurement on a recurring basis using significant unobservable inputs (Level 3), for the years presented (in thousands):

Balance at December 31, 2009	\$ —
Issuance of warrant to purchase 113,371 shares of Series E convertible preferred stock at \$6.174 per share	421
Fair value adjustments recognized other expense	189
Balance at December 31, 2010	610
Issuance of warrant to purchase 48,587 shares of Series E convertible preferred stock at \$6.174 per share	286
Issuance of warrant to purchase 25,285 shares of Series E convertible preferred stock at \$8.8984 per share	182
Fair value adjustments recognized in other expense	321
Balance at December 31, 2011	<u>\$1,399</u>

At December 31, 2010 and 2011, the fair value of the warrants was estimated using the Monte Carlo simulation model with the following assumptions:

	December 31,	
	2010	2011
Expected term (in years)	6.0	4.0
Expected volatility	60.0%	72.0%
Annual risk-free rate of return	2.4%	0.7%
Dividend yield	0.0%	0.0%

Warrants to Purchase Common Stock

On February 16, 2010, the Company entered into a supply and services agreement with a potential customer. As part of the agreement, the Company issued a warrant to purchase up to 11,013 shares of the Company's common stock at a price of \$4.54 per share as a sales incentive to the customer. The potential customer is required to meet certain minimum purchase volumes by March 4, 2012 in order for the warrant to become exercisable. The agreement also allows the potential customer to participate in future equity financings by the

[Table of Contents](#)

Company (prior to an initial public offering), on the same terms and conditions as other investors. The Company was not required to record reductions to net revenues because the Company concluded achievement of the minimum purchase volumes was not probable at each reporting period.

In connection with the Convertible Facility, the Company issued warrants to purchase 131,516 shares of the Company's common stock at approximately \$5.27 per share that are immediately exercisable with a contractual term of five years from the date of issuance.

Shares Reserved for Issuance

As of December 31, 2011, common stock reserved for future issuances was as follows (in thousands):

Series A convertible preferred stock	253
Series B convertible preferred stock	2,022
Series C convertible preferred stock	3,233
Series D convertible preferred stock	12,232
Series E convertible preferred stock	7,431
Warrant to purchase Series C convertible preferred stock	28
Warrant to purchase Series E convertible preferred stock	187
Warrant to purchase common stock	143
Convertible notes	2,328
Stock option plan:	
Options outstanding	6,256
Options available for future grants	514
Total common shares reserved for issuance	<u>34,627</u>

11. STOCK-BASED COMPENSATION

Stock Option Plan—Under the 2006 Equity Incentive Stock Option Plan (the "Plan"), equity awards permitted to be issued include incentive stock options (ISOs), nonstatutory stock options (NSOs), and restricted stock. ISOs may be granted only to employees (including officers and directors who are also employees) of the Company, and NSOs and restricted stock awards may be granted to employees, officers, directors and non-employees of the Company. At December 31, 2010 and 2011, the maximum aggregate number of shares that may be awarded is 6.7 million and 7.5 million, respectively. ISOs and NSOs may be granted at a price per share not less than the fair market value at the date of grant. Options granted generally vest over a four-year period from the date of grant with a contractual term of up to 10 years. Common shares purchased under the Plan are subject to certain restrictions, including the right of first refusal by the Company for sale or transfer of these shares to outside parties. The Company's right of first refusal terminates upon completion of an initial public offering of common stock.

[Table of Contents](#)

A summary of the Company's stock option activity for 2009, 2010 and 2011 is as follows (in thousands, except per share data):

	Shares	Weighted-Average Exercise Price per Share
Options outstanding — December 31, 2008	347	\$ 1.63
Granted (weighted-average fair value of \$0.18 per share)	3,332	0.27
Exercised	(37)	0.84
Canceled	(47)	0.98
Options outstanding — December 31, 2009	3,595	0.39
Granted (weighted-average fair value of \$1.73 per share)	2,548	1.57
Exercised	(111)	0.59
Canceled	(230)	0.53
Options outstanding — December 31, 2010	5,802	0.90
Granted (weighted-average fair value of \$5.08 per share)	1,110	6.16
Exercised	(502)	0.38
Canceled	(154)	2.82
Options outstanding — December 31, 2011	<u>6,256</u>	1.83

At December 31, 2010 and 2011, there were 0.6 million and 0.5 million shares available for future grant issuance under the Plan.

Information about currently outstanding and vested stock options as of December 31, 2011 is as follows:

Range of Exercise Prices	Options Outstanding			Options Exercisable	
	Number of Shares (in thousands)	Weighted-Average Remaining Life (in years)	Weighted-Average Exercise Price	Number of Shares (in thousands)	Weighted-Average Exercise Price
\$0.27-\$0.64	2,855	7.6	\$ 0.31	1,710	\$ 0.30
0.91-1.63	1,908	8.4	1.60	797	1.56
2.09-2.54	730	8.5	2.31	287	2.31
4.09-5.27	287	9.4	4.42	18	4.21
9.53-9.53	476	9.7	9.53	10	9.53
Total	<u>6,256</u>	8.2	1.83	<u>2,822</u>	0.92

As of December 31, 2011, there were 5.8 million options outstanding that were vested, exercisable and expected to vest. Such options have a weighted-average exercise price of \$1.64 and a weighted-average remaining contractual term of 8.2 years. At December 31, 2011, the aggregate intrinsic value was \$26.6 million for the 2.8 million exercisable shares. The intrinsic value is based on the Company's estimated common stock fair value of \$10.35 as of December 31, 2011.

Stock-Based Compensation Expense—The fair value of options granted to employees for purposes of calculating stock-based compensation expense is estimated on the grant date using the Black-Scholes option valuation model. This valuation model requires the Company to make assumptions and judgments about the inputs used in the calculation, including the expected term (weighted-average period of time that the options granted are expected to be outstanding), the volatility of the Company's common stock, a risk-free interest rate, and expected dividend yield. The Company uses the simplified method to calculate the expected term, and

[Table of Contents](#)

volatility is based on an average of the historical volatilities of the common stock of several entities with characteristics similar to those of the Company. The risk-free rate is based on the U.S. Treasury yield curve in effect at the time of grant for periods corresponding with the expected life of the option. The Company's expected dividend yield input was zero as it has not historically paid, nor does it expect in the future to pay, cash dividends on its common stock.

The following table summarizes the components of total stock-based compensation expense included in the consolidated statement of operations for the periods presented (in thousands):

	Year Ended December 31,		
	2009	2010	2011
Cost of revenues	\$ 17	\$ 9	\$ 39
Research and development	62	286	795
Sales and marketing	36	256	671
General and administrative	65	278	615
Total stock-based compensation expense	<u>\$180</u>	<u>\$829</u>	<u>\$2,120</u>

The fair value of each option granted during the periods presented was estimated on the date of grant using the Black-Scholes option-pricing model with the following weighted-average assumptions:

	Year Ended December 31,		
	2009	2010	2011
Expected term (in years)	5.9	6.0	6.0
Expected volatility	76.4%	73.3%	72.0%
Annual risk-free rate of return	2.8%	2.2%	1.8%
Dividend yield	0.0%	0.0%	0.0%

As of December 31, 2011, there was approximately \$6.5 million of total unrecognized compensation cost related to unvested stock options, net of expected forfeitures, which is expected to be recognized over a weighted-average period of 3.0 years.

No income tax benefit has been recognized relating to stock-based compensation expense and no tax benefits have been realized from exercised stock options.

12. INCOME TAXES

No provision for U.S. federal or state income taxes has been made due to cumulative losses since the commencement of operations.

A reconciliation of total income tax expense and the amount computed by applying the federal statutory income tax rate of 34% to loss before income taxes for 2009, 2010 and 2011 is as follows (in thousands):

	Year Ended December 31,		
	2009	2010	2011
Income tax benefit at statutory rate	\$(5,792)	\$(7,284)	\$(10,883)
State taxes, net of federal benefit	(966)	190	(1,956)
Change in valuation allowance	6,601	6,783	12,451
Other nondeductible/nontaxable items	157	311	388
Total tax expense	<u>\$ —</u>	<u>\$ —</u>	<u>\$ —</u>

[Table of Contents](#)

A summary of significant components of the Company's deferred tax assets and liabilities as of December 31, 2010 and 2011 is as follows (in thousands):

	December 31,	
	2010	2011
Current:		
Reserves and allowances	\$ 1,092	\$ 4,641
Other	134	—
Valuation allowance	(1,215)	(4,637)
Total Current	11	4
Non-current:		
Net operating losses	11,175	15,653
Stock based compensation	71	410
Deferred revenue	414	1,435
Fixed assets and intangibles	—	4,716
Valuation allowance	(11,550)	(22,193)
Total non-current	110	21
Deferred tax liability	(121)	(25)
Net deferred tax assets	\$ —	\$ —

Due to the history of losses the Company has generated since inception, the Company believes that it is more-likely-than-not that all of the deferred tax assets will not be realized as of December 31, 2011. Therefore, the Company has recorded a full valuation allowance on its deferred tax assets.

The Company has net operating loss carryforwards for federal and California income tax purposes of approximately \$41 million and \$31 million, respectively, as of December 31, 2011. The federal and state net operating loss carryforwards, if not utilized, will expire beginning in 2026 and 2016, respectively. Utilization of the net operating loss carryforwards may be subject to a substantial annual limitation due to the ownership change limitations provided by the Internal Revenue Code of 1986, as amended, and similar state provisions. The annual limitation may result in the expiration of net operating losses before utilization.

The accounting for uncertain tax positions prescribes a recognition threshold and measurement attribute for the financial statement recognition and measurement of a tax position taken or expected to be taken in a tax return. The Company is required to recognize in the financial statements the impact of a tax position, if that position is more-likely-than-not of being sustained on audit, based on the technical merits of the position. There were no significant unrecognized tax benefits recorded upon adoption and there was no change to the unrecognized tax benefits during 2010 or 2011.

The Company does not have any tax positions for which it is reasonably possible the total amount of gross unrecognized tax benefits will increase or decrease over the next year. The unrecognized tax benefits may increase or change during the next year for items that arise in the ordinary course of business. The Company records interest related to uncertain tax positions as interest and any penalties as other expense.

The Company's tax returns continue to remain subject to examination by U.S. federal authorities for the years 2008 through 2011 and by California state authorities for the years 2007 through 2011.

13. CONCENTRATIONS OF CREDIT RISK AND MAJOR CUSTOMERS

The Company is potentially subject to financial instrument concentration of credit risk through its cash equivalents and trade accounts receivables. The Company places its cash and cash equivalents with major financial institutions, which management assesses to be of high credit quality, in order to limit the exposure of each investment. Trade accounts receivables can be potentially exposed to a concentration of credit risk with its major customers. At December 31, 2011, the Company had amounts due from two customers that represented 24% and 10% of the total accounts receivable balance. As of December 31, 2010, the Company's three largest accounts receivable balances represented 14%, 13% and 10% of the total accounts receivable balance. For the year ended December 31, 2011, three customers accounted for 17%, 11% and 10% of total net revenues. In 2010, two customers accounted for 14% and 11% of total net revenues. In 2009, three customers accounted for 19%, 10% and 10% of total net revenues.

14. NET LOSS PER SHARE ATTRIBUTABLE TO COMMON STOCKHOLDERS

Basic and diluted net loss per share attributable to common stockholders are presented in conformity with the two-class method required for participating securities. Under the two-class method, net loss is allocated between common shares and other participating securities to the extent that the securities are required to share in the losses. The Company's convertible preferred stock does not meet the definition of a participating security in periods of net losses as the convertible preferred stockholders do not have a contractual obligation to share in the Company's losses. Accordingly, net losses are attributable to common stockholders.

Basic net loss per share attributable to common stockholders is calculated by dividing net loss attributable to common stockholders by the weighted average number of shares outstanding for the period.

Diluted net loss per share attributable to common stockholders is calculated by dividing net loss attributable to common stockholders by the weighted average number of common shares and potential dilutive common share equivalents outstanding during the period if the effect is dilutive. The Company's potential dilutive common share equivalents consist of incremental common shares issuable upon the exercise of options and warrants to purchase common shares and upon conversion of its convertible preferred stock and convertible notes.

The following table presents the potential common shares outstanding that were excluded from the computation of diluted net loss per share attributable to common stockholders for the periods presented because including them would have been antidilutive (in thousands):

	Year Ended December 31,		
	2009	2010	2011
Convertible preferred stock	17,740	25,171	25,171
Stock options to purchase common stock	3,595	5,802	6,256
Convertible notes	—	—	2,328
Convertible preferred stock warrants	28	141	215
Common stock warrants	—	11	143
	<u>21,363</u>	<u>31,125</u>	<u>34,113</u>

Unaudited Pro Forma Net Loss Per Share Attributable to Common Stockholders—Pro forma basic and diluted net loss per share attributable to common stockholders have been computed to give effect to the conversion of the Company's convertible preferred stock and the outstanding principal amount and paid-in-kind interest under our Convertible Facility into common stock and the conversion of all outstanding warrants to purchase convertible preferred stock into warrants to purchase common stock as though the conversion had occurred as of the beginning of the period or the original date of issuance if later.

[Table of Contents](#)

The following table sets forth the computation of unaudited pro forma basic and diluted net loss per share attributable to common stockholders for the year ended December 31, 2011 (in thousands, except per share data):

Net loss	\$(32,290)
Pro forma amounts related to the write-off of debt issuance costs and debt discount	(2,994)
Pro forma amounts related to the fair value adjustments for warrants to purchase convertible preferred stock	321
Pro forma net loss used in computing pro forma basic and diluted net loss attributable to common stockholders	<u>\$(34,963)</u>
Pro forma net loss per share attributable to common stockholders, basic and diluted	<u>\$ (1.26)</u>
Pro forma shares used in computing pro forma net loss per share attributable to common stockholders, basic and diluted	<u>27,657</u>

15. GEOGRAPHIC INFORMATION

The Company considers operating segments to be components of the Company in which separate financial information is available that is evaluated regularly by the Company's chief operating decision maker in deciding how to allocate resources and in assessing performance. The chief operating decision maker for the Company is the Chief Executive Officer. The Chief Executive Officer reviews financial information presented on a consolidated basis. The Company has one business activity, which entails the design, development, manufacture and sale of microinverter systems for the solar photovoltaic industry. There are no segment managers who are held accountable for operations, operating results or plans for levels or components below the consolidated unit level. Accordingly, the Company has determined that it has a single reporting segment and operating unit structure.

The following tables present net revenues (based on the destination of the shipments) and long-lived assets by geographic region as of and for the periods presented, (in thousands):

Net Revenues

	Year Ended December 31,		
	2009	2010	2011
United States	\$19,530	\$53,383	\$128,692
Canada	664	8,278	18,525
Other	—	—	2,306
Total	<u>\$20,194</u>	<u>\$61,661</u>	<u>\$149,523</u>

Long-Lived Assets

	December 31,		
	2009	2010	2011
United States	\$3,232	\$5,330	\$11,199
China	662	710	5,974
Other	—	63	1,238
Total property and equipment, net	<u>\$3,894</u>	<u>\$6,103</u>	<u>\$18,411</u>

16. CERTAIN DECEMBER 2011 TRANSACTIONS INCLUDING RELATED PARTY TRANSACTIONS

In December 2011, the Company entered into sales transactions with a customer which is majority-owned by KPCB Holdings, Inc., as nominee (“KPCB”), a related party which owns preferred and common stock and holds convertible notes. Revenue recognized in December 2011 from such sales transactions was \$6.4 million.

Also, in December 2011, the Company entered into agreements to sell microinverters to customers, with product delivery in 2012. Prior to December 31, 2011, the Company received \$23.5 million in cash in advance from these customers; delivery and revenue recognition is expected in the first half of 2012. Of the \$23.5 million received, \$23.0 million was included in deferred revenues and \$0.5 million in other current liabilities in the consolidated balance sheet as of December 31, 2011. These agreements include transactions with customers which are majority-owned by KPCB. Deferred revenues associated with such related parties was \$13.9 million as of December 31, 2011.

17. SUBSEQUENT EVENTS

On March 23, 2012, the Company effected a 1-for-9.08 reverse stock split of the Company’s common stock and Series A, B, C, D and E convertible preferred stock. As a result of the reverse stock split, (i) every 9.08 shares of authorized, issued and outstanding common stock was decreased to one share of authorized, issued and outstanding common stock, (ii) every 9.08 shares of authorized, issued and outstanding convertible preferred stock was decreased to one share of authorized, issued and outstanding convertible preferred stock, (iii) the number of shares of common stock into which each outstanding warrant or option to purchase common stock is exercisable was proportionally decreased on a 1-for-9.08 basis, (iv) the number of shares of convertible preferred stock into which each outstanding warrant to purchase convertible preferred stock is exercisable was proportionately decreased on a 1-for-9.08 basis, (v) the number of shares of common stock issuable upon conversion of each convertible note (including shares issuable related to paid-in-kind interest) was proportionately decreased on a 1-for-9.08 basis, and (vi) all share prices and exercise prices were proportionately increased. All of the share numbers, share prices, and exercise prices have been adjusted within these consolidated financial statements, on a retroactive basis, to reflect this 1-for-9.08 reverse stock split.

On March 27, 2012, the Convertible Facility was further amended to provide for the automatic conversion of the principal amount and paid-in-kind interest under the Convertible Facility into common stock upon closing of this offering at a conversion price equal to the lesser of \$8.8984 or the initial public offering price. On March 28, 2012, the requisite holders of the Company’s convertible preferred stock consented to convert all outstanding shares of the Company’s convertible preferred stock into shares of common stock immediately prior to the closing of this offering.

The Company has evaluated subsequent events through March 28, 2012, the date on which these audited consolidated financial statements were available to be issued.

* * * * *

ENPHASE MICROINVERTER SYSTEM

Overview

Enphase offers microinverter technology for solar energy systems.



Our Microinverter

Our Enphase Microinverters are connected to solar modules on the roof and convert electricity.



Our Communications Gateway

Our Envoy Communications Gateway monitors the performance of each microinverter and solar module.



Our Software

Our Enlighten web-based software provides system owners and installers with performance information about the solar energy system.



PART II
INFORMATION NOT REQUIRED IN THE PROSPECTUS

Item 13. Other Expenses of Issuance and Distribution.

The following table sets forth the costs and expenses, other than underwriting discounts and commissions, to be paid by the registrant in connection with the sale of the shares of common stock being registered hereby. All amounts are estimates except for the SEC registration fee and the FINRA filing fee.

	<u>Amount Paid or to be Paid</u>
SEC registration fee	\$ 11,610
FINRA filing fee	\$ 10,536
NASDAQ Global Market listing fee	\$ 150,000
Printing and engraving	\$ 500,000
Legal fees and expenses	\$ 1,500,000
Accounting fees and expenses	\$ 1,500,000
Blue sky fees and expenses	\$ 15,000
Transfer agent and registrar fees and expenses	\$ 20,000
Miscellaneous	\$ 42,854
Total	<u>\$ 3,750,000</u>

Item 14. Indemnification of Directors and Officers.

We are incorporated under the laws of the State of Delaware. Section 145 of the Delaware General Corporation Law authorizes a court to award, or a corporation's board of directors to grant, indemnity to directors and officers under certain circumstances and subject to certain limitations. The terms of Section 145 of the Delaware General Corporation Law are sufficiently broad to permit indemnification under certain circumstances for liabilities, including reimbursement of expenses incurred, arising under the Securities Act.

As permitted by Section 102(b)(7) of the Delaware General Corporation Law, our certificate of incorporation includes a provision that eliminates, to the fullest extent permitted by law, the personal liability of a director for monetary damages resulting from breach of his fiduciary duty as a director.

As permitted by the Delaware General Corporation Law, our bylaws provide that:

- we are required to indemnify our directors and officers to the fullest extent permitted by the Delaware General Corporation Law;
- we may indemnify our other employees and agents as provided in indemnification contracts entered into between us and our employees and agents;
- we are required to advance expenses, as incurred, to our directors and officers in connection with a legal proceeding to the fullest extent permitted by the Delaware General Corporation Law; and
- the rights conferred in the bylaws are not exclusive.

Our policy is to enter into separate indemnification agreements with each of our directors and officers that provide the maximum indemnity allowed to directors and executive officers by Section 145 of the Delaware General Corporation Law and also provide for certain additional procedural protections. We currently carry liability insurance for our directors and officers. At present, there is no pending litigation or proceeding involving a director or officer of Enphase Energy, Inc. regarding which indemnification is sought, nor are we aware of any threatened litigation that may result in claims for indemnification.

[Table of Contents](#)

These indemnification provisions and the indemnification agreements entered into between us and our officers and directors may be sufficiently broad to permit indemnification of our officers and directors for liabilities (including reimbursement of expenses incurred) arising under the Securities Act.

The Underwriting Agreement filed as Exhibit 1.1 to this registration statement provides for indemnification by the underwriters of us, and our directors and officers for certain liabilities under the Securities Act, or otherwise.

Item 15. Recent Sales of Unregistered Securities.

Since January 1, 2009, we have made sales of the following unregistered securities (share amounts and per share amounts have been retroactively adjusted to give effect to our 1-for 9.08 reverse stock split, which was effected on March 23, 2012):

(a) Issuances of Capital Stock

1. From January 1, 2009 through March 12, 2012, we issued and sold an aggregate of 662,208 shares of our common stock to our employees and consultants at prices ranging from \$0.27 to \$9.53 per share to an aggregate of 71 individuals, pursuant to exercises of options granted under our 2006 Equity Incentive Plan.
2. On March 31, 2009, we sold secured convertible promissory notes to purchase shares of our equity securities to five of our existing accredited investors for an aggregate purchase price of \$1.5 million. On April 24, 2009, the notes and accrued interest of approximately \$8,000 were converted into 831,375 shares of Series D convertible preferred stock.
3. From April 2009 through June 2009, we issued and sold an aggregate of 12,232,498 shares of our Series D preferred stock to 34 accredited investors at \$2.134 per share for an aggregate purchase price of \$25,835,641. Upon completion of this offering, these shares of Series D preferred stock will convert into 12,232,498 shares of our common stock.
4. From March 2010 through May 2010, we issued and sold an aggregate of 7,430,745 shares of our Series E preferred stock to 27 accredited investors at \$6.174 per share for an aggregate purchase price of \$45,880,484. Upon completion of this offering, these shares of Series E preferred stock will convert into 7,430,745 shares of our common stock.

(b) Stock Option Grants and Warrant Issuances

1. From January 1, 2009 through March 12, 2012, we granted stock options to purchase an aggregate of 7,284,150 shares of our common stock at exercise prices ranging from \$0.27 to \$11.00 per share to a total of 329 employees, consultants and directors under our 2006 Equity Incentive Plan, of which options to purchase 460,272 shares were cancelled without being exercised.
2. In March 2010, in connection with the execution of a supply and services agreement, we issued a warrant to purchase 11,013 shares of our common stock to a potential customer for an exercise price of approximately \$4.54 per share. This warrant terminated on March 4, 2012 as a result of such customer's failure to meet certain product purchasing milestones.
3. In March 2010, in connection with our borrowing of an aggregate of \$7.0 million, we issued a warrant to purchase up to an aggregate of 113,371 shares of our Series E preferred stock to the lender for an exercise price of \$6.174 per share. This warrant is immediately exercisable and will expire upon the earlier of March 11, 2020, or five years after the closing of this offering.
4. In March 2011, in connection with our borrowing of an aggregate of \$5.0 million, we issued a warrant to purchase up to an aggregate amount of 48,587 shares of our Series E preferred stock to the lender for an exercise price of \$6.174 per share. This warrant is immediately exercisable and will expire upon the earlier of March 25, 2021, or five years after the closing of this offering.

5. In June 2011, in connection with the execution of a \$5.0 million equipment financing facility, we issued a warrant to purchase up to an aggregate amount of 25,285 shares of our Series E preferred stock to the lender at an exercise price of \$8.8984 per share. This warrant is immediately exercisable and will expire upon the earlier of June 13, 2021, or five years after the closing of this offering.

(c) Issuances of Convertible Notes, Common Stock and Warrants

1. In June 2011, we entered into a junior secured convertible loan facility, or Convertible Facility, with 25 of our preferred stockholders, who are all accredited investors, that provided for up to \$50.0 million in borrowings, of which we borrowed \$12.5 million upon signing. In November 2011, we amended the Convertible Facility to provide for an aggregate of up to \$80.0 million in borrowings. In March 2012, we further amended the Convertible Facility to provide for the automatic conversion of the principal amount and paid-in-kind interest under the Convertible Facility into common stock upon closing of this offering at a conversion price equal to the lesser of \$8.8984 or the initial public offering price of our common stock. We borrowed \$7.5 million in a second advance in November 2011 and may borrow up to an additional \$60 million. The Convertible Facility bears interest at a rate of 9%, with interest payable in kind at maturity. The initial and second advances of \$12.5 million and \$7.5 million, respectively, together with accrued interest, are convertible into common stock at a conversion price equal to the lesser of \$8.8984 or the initial public offering price of our common stock. Additional borrowings and accrued interest are repayable at the holders' option as follows: up to 50% convertible into common stock at a price of equal to the lesser of \$8.8984 or the initial public offering price of our common stock, and the remainder in cash. In addition, we may prepay, at our election, up to 50% of any additional borrowings and related accrued interest at any time. In consideration for the lenders' commitment under this facility, we issued 352,665 shares of common stock at a purchase price of approximately \$5.27 per share to fourteen of the lenders and received proceeds of \$1,096,553 and issued to the remaining lenders warrants to purchase up to an aggregate amount of 131,516 shares of our common stock for an exercise price of approximately \$5.27 per share. The warrants are immediately exercisable. Warrants to purchase 76,601 shares of our common stock will expire on June 14, 2016, and warrants to purchase 54,915 shares of our common stock will expire on November 16, 2016, subject to earlier termination upon an acquisition of us in which the consideration payable to holders of our common stock consists of cash and/or a class of securities that are registered under the Securities Exchange Act of 1934, as amended.

No underwriters were involved in the foregoing sales of securities.

The offers, sales and issuances of the securities described in Item 15(a)(1) and 15(b)(1) were deemed to be exempt from registration under the Securities Act under either (1) Rule 701 promulgated under the Securities Act as offers and sale of securities pursuant to certain compensatory benefit plans and contracts relating to compensation in compliance with Rule 701 or (2) Section 4(2) of the Securities Act as transactions by an issuer not involving any public offering. The recipients of securities in each of these transactions represented their intention to acquire the securities for investment only and not with view to or for sale in connection with any distribution thereof and appropriate legends were affixed to the share certificates and instruments issued in such transactions. All recipients had adequate access, through their relationships with us, to information about us.

The offers, sales, and issuances of the securities described in Items 15(a)(2) and 15(b)(2)-(5) were deemed to be exempt from registration under the Securities Act in reliance on Section 4(2) of the Securities Act as transactions by an issuer not involving a public offering. The offers, sales and issuances of the securities described in Items 15(a)(3)-(4) and 15(c) were deemed to be exempt from registration under the Securities Act in

[Table of Contents](#)

reliance on Regulation D promulgated under the Securities Act, and in connection therewith we filed with the Securities and Exchange Commission: (i) a Form D on May 6, 2009, as subsequently amended on June 25, 2009 with respect to Item 15(a)(2); (ii) a Form D on April 7, 2010, as subsequently amended on June 4, 2010 with respect to Item 15(a)(3); and (iii) a Form D on June 24, 2011, as amended on November 23, 2011, with respect to Item 15(c). The recipients of securities in each of these transactions acquired the securities for investment only and not with a view to or for sale in connection with any distribution thereof, and appropriate legends were affixed to the securities issued in these transactions. Each of the recipients of securities in these transactions was an accredited or sophisticated person and had adequate access, through employment, business or other relationships, to information about us.

Item 16. Exhibits and Financial Statement Schedules.

(a) Exhibits.

<u>Exhibit No.</u>	<u>Description of Exhibit</u>
1.1#	Form of Underwriting Agreement.
3.1#	Amended and Restated Certificate of Incorporation of Enphase Energy, Inc., as amended, as currently in effect.
3.3#	Form of Amended and Restated Certificate of Incorporation of Enphase Energy, Inc., to be effective upon the closing of the offering.
3.4#	Bylaws of Enphase Energy, Inc., as amended, as currently in effect.
3.5#	Form of Amended and Restated Bylaws of Enphase Energy, Inc., to be effective upon the closing of this offering.
4.1#	Specimen Common Stock Certificate of Enphase Energy, Inc.
4.2#	2010 Amended and Restated Investors' Rights Agreement by and between Enphase Energy, Inc. and the investors listed on Exhibit A thereto, dated March 15, 2010, as amended.
4.3#	Common Stock Purchase Warrant, between the Company and MS Solar Solutions Corp, dated March 4, 2010.
4.4#	Warrant to Purchase Shares of Series Preferred Stock, between the Company and Compass Horizon Funding Company LLC, dated March 11, 2010.
4.5#	Warrant to Purchase Shares of Series Preferred Stock, between the Company and Horizon Technology Finance Corporation, dated March 25, 2011.
4.6#	Warrant Agreement to Purchase Shares of Preferred Stock, between the Company and Hercules Technology Growth Capital, Inc., dated June 13, 2011.
4.7#	Form of June 2011 Warrant to Purchase Common Stock of Enphase Energy, Inc., pursuant to that certain Amended and Restated Subordinated Convertible Loan Facility and Security Agreement (filed as Exhibit 10.22 hereto).
4.8#	Form of November 2011 Warrant to Purchase Common Stock of Enphase Energy, Inc., pursuant to that certain Amended and Restated Subordinated Convertible Loan Facility and Security Agreement (filed as Exhibit 10.22 hereto).
5.1#	Opinion of Cooley LLP.
10.1#	Form of Indemnification Agreement to be entered into by and between Enphase Energy, Inc. and each of its directors and officers.
10.2#	2006 Equity Incentive Plan, as amended, and related documents.
10.3#	2011 Equity Incentive Plan and forms of agreement thereunder to be in effect upon the completion of this offering.
10.4#	2011 Employee Stock Purchase Plan to be in effect upon the completion of this offering.
10.5#	Offer Letter by and between Enphase Energy, Inc. and Paul B. Nahi, dated January 1, 2007, as amended.
10.6#	Offer Letter by and between Enphase Energy, Inc. and Sanjeev Kumar, dated November 12, 2009.
10.7#	Employment Agreement by and between Enphase Energy, Inc. and Martin Fornage, dated March 21, 2006, as amended.

Table of Contents

<u>Exhibit No.</u>	<u>Description of Exhibit</u>
10.8#	Offer Letter by and between Enphase Energy, Inc. and Jeff Loebbaka, dated April 19, 2010.
10.9#	Employment Agreement by and between Enphase Energy, Inc. and Raghuvveer R. Belur, dated March 21, 2006, as amended.
10.10#	Amended and Restated Venture Loan and Security Agreement by and between Enphase Energy, Inc., Horizon Technology Finance Corporation and Horizon Credit I LLC, dated March 25, 2011, as amended.
10.11#	Amended and Restated Loan and Security Agreement by and between Enphase Energy, Inc., Bridge Bank, National Association and Comerica Bank, dated March 24, 2011, as amended.
10.12#	Loan and Security Agreement by and between Enphase Energy, Inc. and Hercules Technology Growth Capital, Inc., dated June 13, 2011, as amended.
10.13#	Waterfront Office Building Full Service Lease by and between Enphase Energy, Inc. and Petaluma Theatre District, LLC, dated February 3, 2008, as amended.
10.14#	Redwood Business Park NNN Lease by and between Enphase Energy, Inc. and Sequoia Center LLC, dated June 3, 2011 (1400 North McDowell Boulevard), as amended.
10.15#	Redwood Business Park NNN Lease by and between Enphase Energy, Inc. and Sequoia Center LLC, dated June 3, 2011 (1420 North McDowell Boulevard), as amended.
10.16†#	Cooperation Agreement “AC cabling system for solar micro-inverter” by and among Enphase Energy, Inc., and Phoenix Contact GmbH & Co. KG and Phoenix Contact USA, Inc., dated December 7, 2010.
10.17†#	Flextronics Logistics Services Agreement by and between Enphase Energy, Inc. and Flextronics America, LLC, dated May 1, 2009.
10.18†#	Flextronics Manufacturing Services Agreement by and between Enphase Energy, Inc. and Flextronics Industrial, Ltd., dated March 1, 2009, as amended.
10.19†#	Master Development and Production Agreement by and between Enphase Energy, Inc. and Fujitsu Microelectronics America, Inc., dated August 19, 2009.
10.20†#	License and Technology Transfer Agreement by and between Enphase Energy, Inc. and Ariane Controls, Inc., dated December 21, 2007.
10.21†#	Software License Agreement by and between PVI Solutions, Inc. (subsequently known as Enphase Energy, Inc.) and DCD, Digital Core Design, dated May 8, 2007, as amended.
10.22†#	Amended and Restated Subordinated Convertible Loan Facility and Security Agreement dated as of November 16, 2011 by and between KPCB Holdings, Inc. as nominee (as agent and lender), certain other lenders, and Enphase Energy, Inc.
10.23#	Executive Severance Agreement by and between Enphase Energy, Inc. and Paul B. Nahi, dated June 14, 2011.
10.24#	Change in Control and Severance Agreement by and between Enphase Energy, Inc. and Sanjeev Kumar, dated June 14, 2011.
10.25#	Executive Severance Agreement by and between Enphase Energy, Inc. and Martin Fornage, dated June 14, 2011.
10.26#	Change in Control and Severance Agreement by and between Enphase Energy, Inc. and Jeff Loebbaka, dated June 14, 2011.
10.27#	Executive Severance Agreement by and between Enphase Energy, Inc. and Raghuvveer R. Belur, dated June 14, 2011.
10.28#	Non-employee Director Compensation Policy to be in effect upon completion of this offering.
10.29#	Offer Letter by and between Enphase Energy, Inc. and Greg Steele, dated November 15, 2007.

Table of Contents

<u>Exhibit No.</u>	<u>Description of Exhibit</u>
10.30#	Offer Letter by and between Enphase Energy, Inc. and Bill Rossi, dated August 23, 2010.
10.31#	Offer Letter by and between Enphase Energy, Inc. and Dennis Hollenbeck, dated December 14, 2010.
10.32#	Change in Control and Severance Agreement by and between Energy, Inc. and Greg Steele, dated June 14, 2011.
10.33#	Change in Control and Severance Agreement by and between Energy, Inc. and Bill Rossi, dated June 14, 2011.
10.34#	Change in Control and Severance Agreement by and between Energy, Inc. and Dennis Hollenbeck, dated June 14, 2011.
10.35#	Amended and Restated Voting Agreement by and between Enphase Energy, Inc., the investors listed on Exhibit A thereto and the stockholders listed on Exhibit B thereto, dated March 15, 2010, as amended.
10.36	First Amendment of Amended and Restated Subordinated Convertible Loan Facility and Security Agreement by and between KPCB Holdings, Inc. as nominee (as agent and lender), certain other lenders, and Enphase Energy, Inc., dated March 27, 2012.
23.1#	Consent of Cooley LLP (included in Exhibit 5.1).
23.2	Consent of Deloitte & Touche LLP, independent registered public accounting firm.
23.3#	Consent of Westinghouse Solar.
24.1#	Power of Attorney.
†	Material in the exhibit marked with a “****” has been omitted pursuant to a request for confidential treatment filed with the Securities and Exchange Commission. Omitted portions have been filed separately with the Securities and Exchange Commission.
#	Previously filed.

(b) Financial Statement Schedules.

Financial statement schedules have been omitted, as the information required to be set forth therein is included in the Consolidated Financial Statements or Notes thereto appearing in the prospectus made part of this registration statement.

Item 17. Undertakings.

The undersigned registrant hereby undertakes to provide to the underwriters at the closing, specified in the underwriting agreement, certificates in such denominations and registered in such names as required by the underwriters to permit prompt delivery to each purchaser.

Insofar as indemnification for liabilities arising under the Securities Act may be permitted to directors, officers and controlling persons of the registrant pursuant to the foregoing provisions, or otherwise, the undersigned has been advised that in the opinion of the Securities and Exchange Commission such indemnification is against public policy as expressed in the Act and is, therefore, unenforceable. In the event that a claim for indemnification against such liabilities (other than the payment by the registrant of expenses incurred or paid by a director, officer or controlling person of the registrant in the successful defense of any action, suit or proceeding) is asserted by such director, officer or controlling person in connection with the securities being registered, the registrant will, unless in the opinion of its counsel the matter has been settled by controlling precedent, submit to a court of appropriate jurisdiction the question whether such indemnification by it is against public policy as expressed in the Act and will be governed by the final adjudication of such issue.

[Table of Contents](#)

The undersigned registrant hereby undertakes that:

- (1) For purposes of determining any liability under the Securities Act, the information omitted from the form of prospectus filed as part of this registration statement in reliance upon Rule 430A and contained in a form of prospectus filed by the registrant pursuant to Rule 424(b)(1) or (4) or 497(h) under the Securities Act shall be deemed to be part of this registration statement as of the time it was declared effective.
- (2) For the purpose of determining any liability under the Securities Act, each post-effective amendment that contains a form of prospectus shall be deemed to be a new registration statement relating to the securities offered therein, and the offering of such securities at that time shall be deemed to be the initial bona fide offering thereof.

SIGNATURES

Pursuant to the requirements of the Securities Act of 1933, the registrant has duly caused this Amendment No. 9 to the registration statement to be signed on its behalf by the undersigned, thereunto duly authorized, in the City of Petaluma, State of California, on the 28th day of March, 2012.

Enphase Energy, Inc.

By: /s/ Paul B. Nahi
Paul B. Nahi
President and Chief Executive Officer

[Table of Contents](#)

Pursuant to the requirements of the Securities Act of 1933, as amended, this Amendment No. 9 to the registration statement has been signed by the following persons in the capacities and on the dates indicated.

<u>Signature</u>	<u>Title</u>	<u>Date</u>
<u>/s/ Paul B. Nahi</u> Paul B. Nahi	President and Chief Executive Officer (Principal Executive Officer)	March 28, 2012
<u>/s/ Sanjeev Kumar</u> Sanjeev Kumar	Chief Financial Officer (Principal Financial and Accounting Officer)	March 28, 2012
<u>*</u> Raghuveer R. Belur	Director	March 28, 2012
<u>*</u> Neal Dempsey	Director	March 28, 2012
<u>*</u> Steven J. Gomo	Director	March 28, 2012
<u>*</u> Benjamin Kortlang	Director	March 28, 2012
<u>*</u> Jameson J. McJunkin	Director	March 28, 2012
<u>*</u> Chong Sup Park	Director	March 28, 2012
<u>*</u> Robert Schwartz	Director	March 28, 2012
<u>*</u> Stoddard M. Wilson	Director	March 28, 2012

*By /s/ Paul B. Nahi
Paul B. Nahi
Attorney-in-Fact

EXHIBIT INDEX

<u>Exhibit No.</u>	<u>Description of Exhibit</u>
1.1#	Form of Underwriting Agreement.
3.1#	Amended and Restated Certificate of Incorporation of Enphase Energy, Inc., as amended, as currently in effect.
3.3#	Form of Amended and Restated Certificate of Incorporation of Enphase Energy, Inc., to be effective upon the closing of the offering.
3.4#	Bylaws of Enphase Energy, Inc., as amended, as currently in effect.
3.5#	Form of Amended and Restated Bylaws of Enphase Energy, Inc., to be effective upon the closing of this offering.
4.1#	Specimen Common Stock Certificate of Enphase Energy, Inc.
4.2#	2010 Amended and Restated Investors' Rights Agreement by and between Enphase Energy, Inc. and the investors listed on Exhibit A thereto, dated March 15, 2010, as amended.
4.3#	Common Stock Purchase Warrant, between the Company and MS Solar Solutions Corp, dated March 4, 2010.
4.4#	Warrant to Purchase Shares of Series Preferred Stock, between the Company and Compass Horizon Funding Company LLC, dated March 11, 2010.
4.5#	Warrant to Purchase Shares of Series Preferred Stock, between the Company and Horizon Technology Finance Corporation, dated March 25, 2011.
4.6#	Warrant Agreement to Purchase Shares of Preferred Stock, between the Company and Hercules Technology Growth Capital, Inc., dated June 13, 2011.
4.7#	Form of June 2011 Warrant to Purchase Common Stock of Enphase Energy, Inc., pursuant to that certain Amended and Restated Subordinated Convertible Loan Facility and Security Agreement (filed as Exhibit 10.22 hereto).
4.8#	Form of November 2011 Warrant to Purchase Common Stock of Enphase Energy, Inc., pursuant to that certain Amended and Restated Subordinated Convertible Loan Facility and Security Agreement (filed as Exhibit 10.22 hereto).
5.1#	Opinion of Cooley LLP.
10.1#	Form of Indemnification Agreement to be entered into by and between Enphase Energy, Inc. and each of its directors and officers.
10.2#	2006 Equity Incentive Plan, as amended, and related documents.
10.3#	2011 Equity Incentive Plan and forms of agreement thereunder to be in effect upon the completion of this offering.
10.4#	2011 Employee Stock Purchase Plan to be in effect upon the completion of this offering.
10.5#	Offer Letter by and between Enphase Energy, Inc. and Paul B. Nahi, dated January 1, 2007, as amended.
10.6#	Offer Letter by and between Enphase Energy, Inc. and Sanjeev Kumar, dated November 12, 2009.
10.7#	Employment Agreement by and between Enphase Energy, Inc. and Martin Fornage, dated March 21, 2006, as amended.
10.8#	Offer Letter by and between Enphase Energy, Inc. and Jeff Loebbaka, dated April 19, 2010.
10.9#	Employment Agreement by and between Enphase Energy, Inc. and Raghuvveer R. Belur, dated March 21, 2006, as amended.

Table of Contents

<u>Exhibit No.</u>	<u>Description of Exhibit</u>
10.10#	Amended and Restated Venture Loan and Security Agreement by and between Enphase Energy, Inc., Horizon Technology Finance Corporation and Horizon Credit I LLC, dated March 25, 2011, as amended.
10.11#	Amended and Restated Loan and Security Agreement by and between Enphase Energy, Inc., Bridge Bank, National Association and Comerica Bank, dated March 24, 2011, as amended.
10.12#	Loan and Security Agreement by and between Enphase Energy, Inc. and Hercules Technology Growth Capital, Inc., dated June 13, 2011, as amended.
10.13#	Waterfront Office Building Full Service Lease by and between Enphase Energy, Inc. and Petaluma Theatre District, LLC, dated February 3, 2008, as amended.
10.14#	Redwood Business Park NNN Lease by and between Enphase Energy, Inc. and Sequoia Center LLC, dated June 3, 2011 (1400 North McDowell Boulevard), as amended.
10.15#	Redwood Business Park NNN Lease by and between Enphase Energy, Inc. and Sequoia Center LLC, dated June 3, 2011 (1420 North McDowell Boulevard), as amended.
10.16†#	Cooperation Agreement “AC cabling system for solar micro-inverter” by and among Enphase Energy, Inc., and Phoenix Contact GmbH & Co. KG and Phoenix Contact USA, Inc., dated December 7, 2010.
10.17†#	Flextronics Logistics Services Agreement by and between Enphase Energy, Inc. and Flextronics America, LLC, dated May 1, 2009.
10.18†#	Flextronics Manufacturing Services Agreement by and between Enphase Energy, Inc. and Flextronics Industrial, Ltd., dated March 1, 2009, as amended.
10.19†#	Master Development and Production Agreement by and between Enphase Energy, Inc. and Fujitsu Microelectronics America, Inc., dated August 19, 2009.
10.20†#	License and Technology Transfer Agreement by and between Enphase Energy, Inc. and Ariane Controls, Inc., dated December 21, 2007.
10.21†#	Software License Agreement by and between PVI Solutions, Inc. (subsequently known as Enphase Energy, Inc.) and DCD, Digital Core Design, dated May 8, 2007, as amended.
10.22†#	Amended and Restated Subordinated Convertible Loan Facility and Security Agreement dated as of November 16, 2011 by and between KPCB Holdings, Inc. as nominee (as agent and lender), certain other lenders, and Enphase Energy, Inc.
10.23#	Executive Severance Agreement by and between Enphase Energy, Inc. and Paul B. Nahi, dated June 14, 2011.
10.24#	Change in Control and Severance Agreement by and between Enphase Energy, Inc. and Sanjeev Kumar, dated June 14, 2011.
10.25#	Executive Severance Agreement by and between Enphase Energy, Inc. and Martin Fornage, dated June 14, 2011.
10.26#	Change in Control and Severance Agreement by and between Enphase Energy, Inc. and Jeff Loebbaka, dated June 14, 2011.
10.27#	Executive Severance Agreement by and between Enphase Energy, Inc. and Raghuvveer R. Belur, dated June 14, 2011.
10.28#	Non-employee Director Compensation Policy to be in effect upon completion of this offering.
10.29#	Offer Letter by and between Enphase Energy, Inc. and Greg Steele, dated November 15, 2007.
10.30#	Offer Letter by and between Enphase Energy, Inc. and Bill Rossi, dated August 23, 2010.
10.31#	Offer Letter by and between Enphase Energy, Inc. and Dennis Hollenbeck, dated December 14, 2010.

Table of Contents

<u>Exhibit No.</u>	<u>Description of Exhibit</u>
10.32#	Change in Control and Severance Agreement by and between Energy, Inc. and Greg Steele, dated June 14, 2011.
10.33#	Change in Control and Severance Agreement by and between Energy, Inc. and Bill Rossi, dated June 14, 2011.
10.34#	Change in Control and Severance Agreement by and between Energy, Inc. and Dennis Hollenbeck, dated June 14, 2011.
10.35#	Amended and Restated Voting Agreement by and between Enphase Energy, Inc., the investors listed on Exhibit A thereto and the stockholders listed on Exhibit B thereto, dated March 15, 2010, as amended.
10.36	First Amendment of Amended and Restated Subordinated Convertible Loan Facility and Security Agreement by and between KPCB Holdings, Inc. as nominee (as agent and lender), certain other lenders, and Enphase Energy, Inc., dated March 27, 2012.
23.1#	Consent of Cooley LLP (included in Exhibit 5.1).
23.2	Consent of Deloitte & Touche LLP, independent registered public accounting firm.
23.3#	Consent of Westinghouse Solar.
24.1#	Power of Attorney.
†	Material in the exhibit marked with a “***” has been omitted pursuant to a request for confidential treatment filed with the Securities and Exchange Commission. Omitted portions have been filed separately with the Securities and Exchange Commission.
#	Previously filed.

FIRST AMENDMENT OF AMENDED AND RESTATED SUBORDINATED
 CONVERTIBLE LOAN FACILITY AND SECURITY AGREEMENT

This FIRST AMENDMENT OF AMENDED AND RESTATED SUBORDINATED CONVERTIBLE LOAN FACILITY AND SECURITY AGREEMENT (this "Amendment") is entered into as of March 27, 2012 by and among Enphase Energy, Inc., a Delaware corporation ("Borrower"), KPCB Holdings, Inc., as nominee, a California corporation ("KPCB"), as a Lender under the Amended and Restated Subordinated Convertible Loan Facility and Security Agreement dated as of November 16, 2011 (the "Agreement") and in its capacity as Agent on behalf of the Lenders thereunder, and the other Persons named therein (together with KPCB, referred to herein individually as a "Lender" and collectively as the "Lenders").

A. The Borrower and the Lenders previously entered into the Agreement.

B. The undersigned parties, who hold more than 60% of the Indebtedness outstanding under the Agreement required for amendments to the Agreement pursuant to Section 12.5(c) of the Agreement, desire to amend the Agreement in accordance with the terms set forth herein.

NOW, THEREFORE, in consideration of the foregoing and other good and valuable consideration, the receipt and sufficiency of which are hereby acknowledged, the parties hereto hereby agree to amend and restate the Agreement as follows:

1. The definition of "Conversion Price" in Section 1 of Schedule II of the Agreement shall be amended and restated in its entirety to read as follows:

"Conversion Price" means the lowest of (a) \$8.8984 per share (which reflects adjustment for the Reverse Stock Split as defined in Article IV of the Borrower's certificate of incorporation), (b) the per share offering price to the public of the IPO or (c) the lowest per share selling price of any shares of capital stock sold by Borrower following the Effective Date, other than shares of capital stock sold in a transaction that would be exempt from the anti-dilution rights of the holders of Borrower's preferred stock pursuant to clauses (i) through (viii) of Article V, Section 5.8.2(a) of the Borrower's certificate of incorporation. The Conversion Price is subject to adjustment as provided herein."

2. Section 2 of Schedule II of the Agreement shall be amended and restated in its entirety to read as follows:

"2. CONVERSION.

2.1 Conversion Prior to Repayment.

(a) Automatic Conversion upon an IPO. In the event the Maturity Date occurs due to the consummation of an IPO, the entire Maximum Conversion Amount of each Loan shall be cancelled and converted into the number of shares of Conversion Stock obtained

by dividing (i) the entire Maximum Conversion Amount of each Loan by (ii) the Conversion Price.

(b) Optional Conversion in Other Events. In the event the Maturity Date occurs due to an event other than the consummation of an IPO, upon the election of a Lender with respect to any Loan made by it, which election shall be exercised by written notice from such Lender given to Borrower prior to Borrower's repayment in full of the outstanding balance of such Loan (which election, in the event the Maturity Date is anticipated to occur due to the consummation of a Change in Control, may at Lender's option be made contingent upon the completion of such Change in Control), the entire Maximum Conversion Amount of such Loan, or any portion thereof as specified in such election of the Lender, shall be cancelled and converted into that number of shares of Conversion Stock obtained by dividing (i) the entire Maximum Conversion Amount of such Loan or portion thereof specified by the Lender, by (ii) the Conversion Price.

2.2 Timing of Conversion; Tender of Note or Addendum Thereto for Conversion. In connection with a conversion pursuant to Section 2.1, a Lender shall deliver the original Note or the applicable addendum thereto corresponding to such Loan (or Lost Note Documentation, if applicable) to Borrower. If pursuant to Section 2.1(b) a Lender elects to convert only a portion of the Loan represented by a Note or addendum, as the case may be, then promptly after (and in any event within 7 days after) receipt of the original Note or such addendum (or Lost Note Documentation, if applicable) Borrower shall re-issue such Lender a new Note or addendum reflecting the portion of such Loan that was not converted and remains outstanding. If a Lender delivers written notice of an election to convert a Loan (or portion thereof) within the time period specified in Section 2.1(b), the conversion of such Loan (or portion thereof) into Conversion Stock shall be deemed to occur upon the earlier of (i) the date of such Lender's written notice (unless the Lender has elected to make conversion of the Loan contingent on the consummation of a Change in Control) and (ii) immediately prior to the Maturity Date, without regard to whether Lender has then delivered to Borrower the Note(s) corresponding to the Loan so converted (or the Lost Note Documentation where applicable) or executed any other documents.

2.3 Termination of Rights. Except for the right to obtain certificates representing the Conversion Stock under Section 3 below, all rights with respect to a Loan (or portion thereof) converted pursuant this Section 2 shall terminate upon the effective conversion of such Loan (or portion thereof) as provided in Section 2.1 above."

3. On and after the date hereof, each reference to the Agreement in the Agreement or in any other document shall mean the Agreement as amended by this Amendment. Except as modified by this Amendment, the Agreement remains in full force and effect in all respects without any modification. This Amendment may be executed in two or more counterparts, each of which shall be deemed an original, but all of which together shall constitute one and the same instrument. This Amendment may be executed by signatures delivered by e-mail or facsimile.

[Remainder of page intentionally left blank.]

IN WITNESS WHEREOF, the parties hereto have caused this Agreement to be executed as of the date first above written.

BORROWER:

ENPHASE ENERGY, INC.

By: /s/ Paul B. Nahi
Name: Paul B. Nahi
Title: President and Chief Executive Officer

**[Signature Page to First Amendment
of Amended and Restated Subordinated Convertible Loan Facility and Security Agreement]**

IN WITNESS WHEREOF, the parties hereto have caused this Amendment to be executed as of the date first above written.

LENDER:

BAY PARTNERS XI, L.P.

By: Bay Management Company XI, LLC, General Partner

By: /s/ Neal Dempsey
Neal Dempsey, Manager

BAY PARTNERS XI PARALLEL FUND, L.P.

By: Bay Management Company XI, LLC, General Partner

By: /s/ Neal Dempsey
Neal Dempsey, Manager

Address: 490 South California Avenue, Suite 200
Palo Alto, CA 94306

**[Signature Page to First Amendment
of Amended and Restated Subordinated Convertible Loan Facility and Security Agreement]**

IN WITNESS WHEREOF, the parties hereto have caused this Amendment to be executed as of the date first above written.

LENDER:

MADRONE PARTNERS, L.P.

By: Madrone Capital Partners, LLC, its general partner

By: /s/ Jameson McJunkin

Name: Jameson McJunkin

Title: Managing Member

Address: 3000 Sand Hill Road
Building 1, Suite 150
Menlo Park, CA 94025

**[Signature Page to First Amendment
of Amended and Restated Subordinated Convertible Loan Facility and Security Agreement]**

IN WITNESS WHEREOF, the parties hereto have caused this Amendment to be executed as of the date first above written.

LENDER:

KPCB HOLDINGS, INC., AS NOMINEE

By: /s/ John Denniston
Name: John Denniston
Title: Senior Vice President

Address: c/o Kleiner Perkins Caufield & Byers
2750 Sand Hill Road
Menlo Park, CA 94025

**[Signature Page to First Amendment
of Amended and Restated Subordinated Convertible Loan Facility and Security Agreement]**

CONSENT OF INDEPENDENT REGISTERED PUBLIC ACCOUNTING FIRM

We consent to the use in this Amendment No. 9 to Registration Statement No. 333-174925 on Form S-1 of our report dated February 22, 2012 (March 28, 2012 as to the effects of the reverse split described in the first paragraph of Note 17 and the second paragraph of Note 17) relating to the consolidated financial statements of Enphase Energy, Inc. appearing in the Prospectus, which is part of this Registration Statement.

We also consent to the reference to us under the heading "Experts" in such Prospectus.

/s/ Deloitte & Touche LLP
San Francisco, California
March 28, 2012