

**UNITED STATES
SECURITIES AND EXCHANGE COMMISSION
Washington, D.C. 20549**

**Amendment No. 1
to
FORM S-1
REGISTRATION STATEMENT**

**UNDER
THE SECURITIES ACT OF 1933**

ENPHASE ENERGY, INC.

(Exact name of registrant as specified in its charter)

Delaware
(State or other jurisdiction of
incorporation or organization)

3674
(Primary Standard Industrial
Classification Code Number)

20-4645388
(I.R.S. Employer
Identification Number)

**201 1st Street, Suite 100
Petaluma, CA 94952
(707) 774-7000**
(Address, including zip code, and telephone number, including area code, of Registrant's principal executive offices)

Paul B. Nahi
Chief Executive Officer
c/o Enphase Energy, Inc.
201 1st Street, Suite 100
Petaluma, CA 94952
(707) 774-7000
(Name, address, including zip code, and telephone number, including area code, of agent for service)

Copies to:

John H. Sellers
Cooley LLP
3175 Hanover Street
Palo Alto, CA 94304
(650) 843-5000

Bruce K. Dallas
Davis Polk & Wardwell LLP
1600 El Camino Real
Menlo Park, CA 94025
(650) 752-2000

Approximate date of commencement of proposed sale to the public: As soon as practicable after the effective date of this registration statement.

If any of the securities being registered on this Form are to be offered on a delayed or continuous basis pursuant to Rule 415 under the Securities Act of 1933, check the following box.

If this Form is filed to register additional securities for an offering pursuant to Rule 462(b) under the Securities Act, check the following box and list the Securities Act registration statement number of the earlier effective registration statement for the same offering.

If this Form is a post-effective amendment filed pursuant to Rule 462(c) under the Securities Act, check the following box and list the Securities Act registration statement number of the earlier effective registration statement for the same offering.

If this Form is a post-effective amendment filed pursuant to Rule 462(d) under the Securities Act, check the following box and list the Securities Act registration number of the earlier effective registration statement for the same offering.

Indicate by check mark whether the registrant is a large accelerated filer, an accelerated filer, a non-accelerated filer, or a smaller reporting company. See the definition of "accelerated filer," "large accelerated filer," "non-accelerated filer" and "smaller reporting company" in Rule 12b-2 of the Act.

Large accelerated filer

Accelerated filer

Non-accelerated filer
(Do not check if a smaller reporting company)

Smaller reporting company

The Registrant hereby amends this Registration Statement on such date or dates as may be necessary to delay its effective date until the Registrant shall file a further amendment that specifically states that this Registration Statement shall thereafter become effective in accordance with Section 8(a) of the Securities Act of 1933, as amended, or until the Registration Statement shall become effective on such date as the Commission, acting pursuant to said Section 8(a), may determine.

PROSPECTUS (Subject to Completion)
Issued July 25, 2011



Enphase Energy, Inc. is offering _____ shares of its common stock. This is our initial public offering and no public market currently exists for our shares. We anticipate that the initial public offering price of our common stock will be between \$ _____ and \$ _____ per share.

We intend to apply to list our common stock on the NASDAQ Global Market under the symbol "ENPH."

Investing in our common stock involves substantial risks. See "[Risk Factors](#)" beginning on page 10.

	PRICE \$	A SHARE		
		Price to Public	Underwriting Discounts and Commissions	Proceeds to Enphase
Per Share		\$	\$	\$
Total		\$	\$	\$

We have granted the underwriters the right to purchase up to an additional _____ shares of common stock to cover over-allotments.

The Securities and Exchange Commission and state securities regulators have not approved or disapproved of these securities or determined if this prospectus is truthful or complete. Any representation to the contrary is a criminal offense.

The underwriters expect to deliver the shares of common stock to purchasers on _____, 2011.

MORGAN STANLEY

BofA MERRILL LYNCH

JEFFERIES

LAZARD CAPITAL MARKETS

THINKEQUITY LLC

_____, 2011

The information in this prospectus is not complete and may be changed. We may not sell these securities until the registration statement filed with the Securities and Exchange Commission is effective. This prospectus is not an offer to sell these securities and we are not soliciting offers to buy these securities in any state where the offer or sale is not permitted.

Welcome

to the next phase of solar

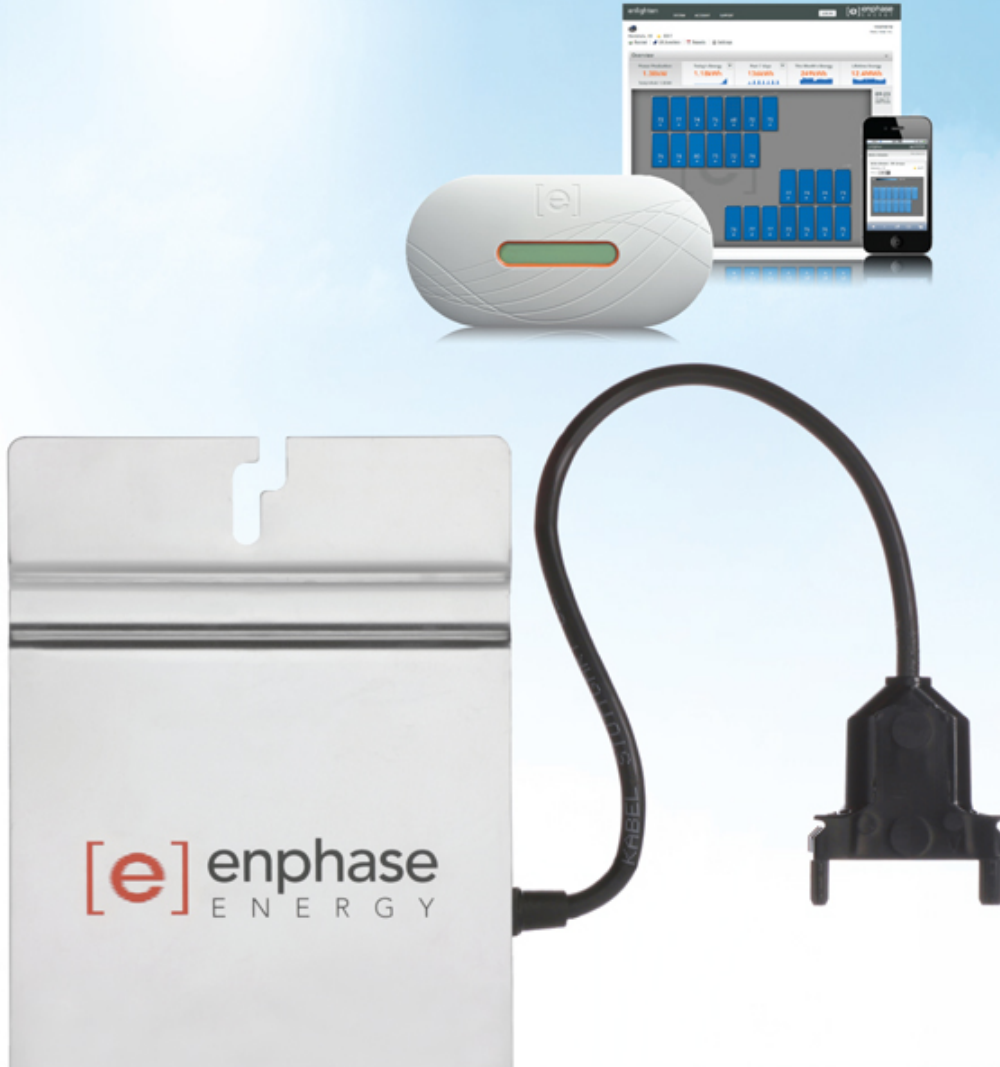

[e] enphase
ENERGY

TABLE OF CONTENTS

	<u>Page</u>		<u>Page</u>
Prospectus Summary	1	Compensation Discussion and Analysis	92
Risk Factors	10	Executive Compensation	100
Special Note Regarding Forward-Looking Statements and Industry Data	30	Certain Relationships and Related Party Transactions	118
Use of Proceeds	32	Principal Stockholders	125
Dividend Policy	33	Description of Capital Stock	128
Capitalization	34	Shares Eligible for Future Sale	133
Dilution	36	Material U.S. Federal Income and Estate Tax Consequences to Non-U.S. Holders	136
Selected Consolidated Financial Data	38	Underwriters	140
Management's Discussion and Analysis of Financial Condition and Results of Operations	40	Legal Matters	146
Business	61	Experts	146
Management	84	Where You Can Find More Information	146
		Index to Consolidated Financial Statements	F-1

Neither we nor the underwriters have authorized anyone to provide you with information other than that contained in this prospectus or any free writing prospectus prepared by or on behalf of us or to which we have referred you. We take no responsibility for, and can provide no assurance as to the reliability of, any information that others may give you.

We are offering to sell, and seeking offers to buy, common stock only in jurisdictions where offers and sales are permitted. The information contained in this prospectus is accurate only as of the date of this prospectus, regardless of the time of delivery of this prospectus or of any sale of our common stock.

Until and including [redacted], 2011 (25 days after the date of this prospectus), all dealers that buy, sell or trade our common stock, whether or not participating in this offering, may be required to deliver a prospectus. This delivery requirement is in addition to the obligation of dealers to deliver a prospectus when acting as underwriters and with respect to their unsold allotments or subscriptions.

No action is being taken in any jurisdiction outside the United States to permit a public offering of the common stock or possession or distribution of this prospectus in that jurisdiction. Persons who come into possession of this prospectus in jurisdictions outside the United States are required to inform themselves about and to observe any restrictions as to this offering and the distribution of this prospectus applicable to that jurisdiction.

Unless the context indicates otherwise, we use the terms "Enphase Energy," "Enphase," "we," "us" and "our" in this prospectus to refer to Enphase Energy, Inc. and its subsidiaries.

PROSPECTUS SUMMARY

This summary highlights information contained elsewhere in this prospectus and does not contain all of the information that you should consider in making your investment decision. Before investing in our common stock, you should carefully read this entire prospectus, including our consolidated financial statements and the related notes thereto and the information set forth under the sections “Risk Factors” and “Management’s Discussion and Analysis of Financial Condition and Results of Operations,” in each case appearing elsewhere in this prospectus.

ENPHASE ENERGY, INC.

We have pioneered a fundamentally new inverter technology for the solar industry that increases energy production, simplifies design and installation, improves system uptime and reliability, reduces fire safety risk and provides a platform for intelligent energy management. To date, the solar industry has relied on the traditional central inverter approach that has largely remained unchanged for the past two decades. We have built from the ground up a semiconductor-based microinverter system that converts direct current (DC) electricity to alternating current (AC) electricity at the individual solar module level, and bring a system-based, high technology approach to solar energy generation leveraging our design expertise across power electronics, semiconductors, networking and embedded and web-based software technologies. We created the microinverter category and have grown rapidly since our first commercial shipment in mid-2008, with more than 750,000 units shipped through May 31, 2011, representing over an estimated 25,000 solar installations. Given significant advantages over traditional central inverters, we believe that microinverter solutions will become the standard for residential and commercial solar.

Our microinverter systems have been installed in all 50 U.S. states and eight Canadian provinces. We are rapidly taking market share from traditional central inverter manufacturers. For example, in California, the largest single solar market in the U.S., based on estimates by Solar Energy Industries Association, or SEIA, our market share of the residential solar photovoltaics, or PV, inverter market has increased from 0% in mid-2008 to almost 20% during the first half of 2011 according to the California Solar Initiative, or CSI.

California Residential Market Share (July 2008 - May 2011)
Enphase Energy Market Share – 3-Month Moving Average Based on Megawatts

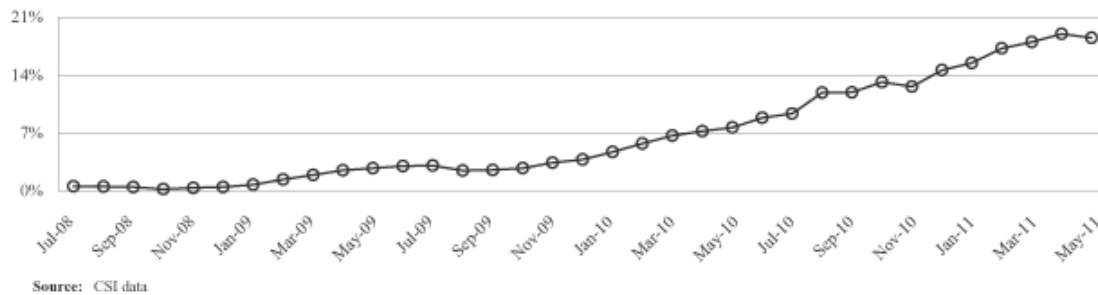

We sell our microinverter systems primarily to distributors who resell them to solar installers. We have developed a network of over 2,500 installers in North America through May 31, 2011 and are adding approximately 100 new installers per month. We also sell directly to large installers as well as through original equipment manufacturers, or OEMs, and strategic partners. A substantial majority of our revenue has been generated by sales within the United States. Sales to customers in Canada commenced in 2009 and accounted for approximately 13% of our total revenue in 2010. In early 2011, we established sales offices in France and Italy.

Market Opportunity

The global solar PV market witnessed rapid growth from 7 gigawatts (GW), or \$38 billion, of installed capacity coming online during 2009 to 17 GW, or \$75 billion, in 2010, and is expected to grow to 41 GW in 2015, representing a compounded annual growth rate of 19%, according to iSuppli Corporation. The solar PV market consists of two primary on-grid solar markets: distributed solar systems for residential and commercial buildings, and centralized large scale solar PV installations owned and operated by utilities.

Historically, traditional central inverters have been the only inverter technology used for solar PV installations. As compared to microinverter systems, we believe that traditional central inverters have a number of design and performance challenges limiting innovation and their ability to reduce cost of solar systems, including the following:

- *Productivity limits.* If solar modules are wired using a traditional central inverter—such that a group or “string” of modules are wired in series—an entire string’s output is limited by the output of the lowest-performing module. Because of its string design, there is a single point of failure risk with the traditional central inverter approach.
- *Reliability issues.* Traditional central inverters are the single most common component of solar installations to fail, resulting in system downtime and adversely impacting total energy output. As a result, central inverters typically carry warranties of only 5 to 10 years.
- *Complex design and installation requirements.* The central inverter-based solar PV installation requires greater effort on the part of the installer, both in terms of design and on-site labor. Central inverter installations require string design and calculations for safe and reliable operation, as well as specialized equipment such as DC combiners, conduits and disconnects. In addition, the use of high-voltage DC requires specialized knowledge and training and safety precautions to install central inverter technology.
- *Lack of monitoring.* The majority of solar installations with central inverter technology offer limited monitoring capabilities. A failure of the central inverter will often go unnoticed for days or even weeks. If a module fails or is not performing to specification, the resulting loss of energy can go unnoticed for an extended period of time.
- *Safety issues.* Central inverter solar PV installations have a wide distribution of high-voltage (600 volts in the United States and 1,000 volts in Europe) DC wiring. If damaged, DC wires can generate sustained electrical arcs, reaching temperatures of more than 5,000 °F. This creates the risk of fire for solar PV installation owners and injury for installers and maintenance personnel.

These challenges of traditional central inverters have a direct impact on the cost and expected return on investment of solar installations to both installers and system owners:

- *Installer.* Solar PV installers aim for simple installation design, fast installation times and maximum system performance and predictability. The installation of high-voltage DC central inverter technology, however, requires significant preparation, precautionary safety measures, time-consuming string calculations, extensive design expertise and specialized installation equipment, training and knowledge. Together, these factors significantly increase complexity and cost of installation and limit overall productivity for the installer.
- *System owner.* Solar system owners aim for high energy production, low cost, high reliability and low maintenance requirements, as well as reduced fire risks. With traditional central inverters, owners often are unable to optimize the size or shape of their solar PV installations due to string design limitations. As such, they experience performance loss from shading and other obstructions, can face frequent system failures and lack the ability to effectively monitor the performance of their solar PV installation.

In addition, central inverter installations operate at high-voltage DC which bears significant fire risks. Further, due to their large size, central inverter installations can affect architectural aesthetics of the house or commercial building.

Our Solution

Our microinverter solution brings a system-based, high technology approach to solar energy generation leveraging our design expertise across power electronics, semiconductors, networking, and embedded and web-based software technologies. Our microinverter system consists of three key components: our Enphase microinverter, Envoy communications gateway and Enlighten web-based software:

- Our industry leading Enphase microinverter delivers efficient and reliable power conversion at the individual solar module level by introducing a digital architecture that incorporates custom application specific integrated circuits, or ASICs, specialized power electronics devices and an embedded software subsystem that optimizes energy production from each module and manages the core ASIC functions.
- Our Envoy communications gateway is installed in the system owner's home or business and serves as a networking hub that collects data from the microinverter array and sends the information to our hosted data center.
- Our Enlighten web-based software collects and analyzes this information to enable system owners to monitor and realize the highest performance of their solar PV system and also provides an online portal specifically designed for installers to enable them to track and manage all of their Enphase enabled projects and monitor and analyze the performance of their installed systems. Historically, Enlighten service revenue has represented less than 1% of total revenues in each reporting period.

Together, our Enphase microinverter, Envoy communications gateway and Enlighten web-based software function as a single unified system that enhances energy production, simplifies design and installation, reduces costs, increases system uptime and reliability, reduces fire safety risk and provides the ability to monitor performance at the individual module level in real-time. With an Enphase microinverter system, we believe solar system owners can achieve a higher return on investment over the lifetime of the solar system than would be achieved using a traditional central inverter approach.

Key elements of our solution include:

- *Productive—Superior Energy Production.* Our microinverter system enables the maximum possible energy production from each module, overcoming a fundamental design limitation of central inverters which are limited by the lowest performing module.
- *Reliable—Longer Life and No Single Point of Failure.* Reduction of component count, primarily through semiconductor integration in our microinverter, and the distributed architecture of our microinverter system, allow us to design a reliable system that can withstand harsh environmental conditions and offer system owners a 100% system uptime guarantee.
- *Simple—Ease of Design and Installation.* Using microinverter technology, an installer can design a system of any size and any roof configuration with a simple modular approach, with minimal impact to the aesthetics of a home or building.
- *Smart—Module-Level Monitoring and Analytics.* Our microinverter system allows us to collect energy production information in real-time on a per solar module basis, offering installers and system owners visibility into how their system is performing and the ability to continuously optimize energy production.

- *Safe—“All AC” Solution.* Important to both installers and system owners, microinverters are safer because they process low DC voltages relative to central inverters.

Competitive Strengths

We believe the following combination of capabilities and features of our business model distinguish us from our competitors and position us well to capitalize on the expected growth in the solar market and to become a global leader in the broader solar power industry:

- *First to Market and Rapid Adoption.* We created the microinverter product category, and believe that this early-mover advantage and proven ability to innovate quickly will continue to allow us to build on our leading market position.
- *System Approach.* By integrating the Enphase microinverter technology with Envoy, our proprietary communications gateway, and our Enlighten web-based software, we offer significant design and operating benefits beyond the core power conversion functionality.
- *Strong Focus on Technology and Research and Development.* Our proximity to Silicon Valley and the past experience of our founders and executive officers in the technology industry have enabled us to recruit engineers with strong skills in power electronics, semiconductors, powerline communications and networking, and software design, which we have complemented with significant solar industry expertise from other members of our team.
- *Field-Proven Reliability.* We have established industry leading reliability as represented by a mean time between failure, or MTBF, rate of approximately 0.3% per year, and according to data from Westinghouse Solar, microinverters are 45 times more reliable than central inverters.
- *Capital Efficient and Scalable Manufacturing.* We outsource all of our hardware manufacturing to manufacturing partners, including Flextronics, resulting in a low fixed-cost structure and reduced capital expenditure and working capital requirements.
- *Rapidly Expanding Distribution Channels.* Since we shipped our first microinverter system in 2008, the base of installers using our products has grown to over 2,500 installers in North America as of May 31, 2011, and we are currently adding new installers at the rate of approximately 100 each month.
- *Intense Focus on Customer Service for Installers.* We believe we have cultivated an organizational focus on installer satisfaction that differentiates us from central inverter manufacturers, resulting in a high level of installer retention and “repeat” business.

Our Strategy

Our objective is to continue to be the leading provider of microinverter systems for the solar industry worldwide and to accelerate the shift from traditional central inverters to microinverter technology. Key elements of our strategy include:

- *Continue to Penetrate Our Core Markets.* We intend to capitalize on our technology leadership and growing momentum with installers and owners to further our market share position in our core markets in the United States and Canada.
- *Enter New Geographic Markets Rapidly.* We intend to expand into new markets with new products and local go-to-market capabilities, including France, Italy and the Benelux region.
- *Increase Power and Efficiency and Reduce Cost per Watt.* Our engineering team is focused on continuing to increase average power conversion efficiency above 96% and AC output power beyond 215 watts and further reducing cost per watt.

- *Expand Our Technology Leadership.* We distinguish ourselves from other inverter companies with our system-based and high-tech approach, and the ability to leverage strong research and development capabilities.
- *Extend Our Product Offering for Larger Commercial and Utility-Scale Installations.* We intend to expand our product offering by introducing new microinverter systems targeted at larger commercial and utility-scale installations.
- *Development of a Smart Energy Management Platform.* We intend to build upon our strong position as the leading supplier of microinverters and energy management systems to expand beyond solar and to create a smart energy management platform for integrated smart energy devices and services.

Challenges

Before you invest in our stock, you should carefully consider all the information in this prospectus, including matters set forth under the heading “Risk Factors.” We believe that the following are some of the major risks and uncertainties that may affect us:

- *Operating Losses.* We have incurred net losses since our inception, we expect to incur net losses in 2011 and we may continue to incur additional net losses in future years as we continue to invest substantial resources to support the growth of our business.
- *Operating History.* We have only been in existence since 2006 and did not begin shipping our products in commercial quantities until mid-2008, and this limited operating history makes it difficult to evaluate our current business and future prospects.
- *Demand for Solar Energy Solutions.* Our future success depends on continued demand for solar energy solutions and the ability of solar equipment vendors to meet this demand. If the demand for solar energy solutions does not continue to grow or grows at a slower rate than we anticipate, our business will suffer.
- *Government Subsidies.* Reductions in, or eliminations or expirations of, governmental incentives could result in decreased demand for and lower revenue from solar PV systems, which would adversely affect sales of our products.
- *Market Acceptance.* If we fail to achieve broad market acceptance of our products, there would be an adverse impact on our ability to increase our revenue, gain market share and achieve and sustain profitability.
- *Gross Profit and Profitability.* Our gross profit has varied in the past and is likely to continue to vary significantly from period to period, and fluctuations in gross profit may adversely affect our ability to manage our business or achieve or maintain profitability.
- *Competition.* The inverter industry is highly competitive and we expect to face increased competition as new and existing companies introduce microinverter products which could negatively impact our results of operations and market share.
- *Initial Capital Investments.* Our microinverter system may require a higher upfront capital investment than our competition’s central inverter products, and our potential customers may be unwilling to invest more capital upfront, which would negatively impact our growth and sales.

Corporate Information

We were incorporated as PVI Solutions, Inc. in March 2006 in the State of Delaware and changed our name to Enphase Energy, Inc. in July 2007. Our principal executive offices are located at 201 1st Street, Suite 100, Petaluma, CA 94952, USA, and our telephone number is (707) 774-7000. Our website address is www.enphase.com. Information contained on our website is not incorporated by reference into this prospectus, and you should not consider information contained on our website to be part of this prospectus or in deciding whether to purchase shares of our common stock.

Our name is a registered trademark of Enphase Energy, Inc. This prospectus contains additional trade names and trademarks of ours and of other companies.

THE OFFERING

Common stock offered by us shares

Over-allotment option shares

Common stock to be outstanding after this offering shares

Use of proceeds We anticipate that we will use the net proceeds of this offering primarily for working capital for the growth of our business and other general corporate purposes. Pending the specific use of net proceeds as described in this prospectus, we intend to invest the net proceeds to us from this offering in short-term investment grade and U.S. government securities. See “Use of Proceeds.”

Proposed NASDAQ symbol “ENPH”

The number of shares of our common stock that will be outstanding immediately after this offering is based on 241,996,235 shares of common stock outstanding as of June 30, 2011, after giving effect to the conversion of our outstanding convertible preferred stock into 228,552,739 shares of common stock immediately prior to the completion of this offering, and excludes:

- 2,747,165 shares of common stock issuable upon exercise of outstanding warrants as of June 30, 2011, with a weighted-average exercise price of \$0.66 per share;
- 53,885,595 shares of common stock issuable upon the exercise of outstanding stock options under our 2006 Equity Incentive Plan, as of June 30, 2011, with a weighted-average exercise price of \$0.13 per share;
- 24,000,000 shares of common stock reserved for future issuance under our 2011 Equity Incentive Plan, which will become effective prior to the completion of this offering and contains provisions that will automatically increase its share reserve each year, as more fully described in “Executive Compensation—Employee Benefit Plans”;
- 6,080,000 shares of common stock reserved for future issuance under our 2011 Employee Stock Purchase Plan, which will become effective prior to the completion of this offering and contains provisions that will automatically increase its share reserve each year, as more fully described in “Executive Compensation—Employee Benefit Plans”; and
- 12,755,102 shares of common stock issuable upon conversion of the outstanding principal amount of our junior secured convertible loan facility at a conversion price of \$0.98 per share.

Unless otherwise indicated, all information in this prospectus assumes:

- the automatic conversion of all outstanding shares of our preferred stock into shares of our common stock effective immediately prior to the closing of this offering;
- the automatic conversion of outstanding warrants to purchase shares of our convertible preferred stock into warrants to purchase an aggregate number of 1,951,579 shares of common stock immediately prior to the completion of this offering;
- the amendment and restatement of our certificate of incorporation and the amendment and restatement of our bylaws immediately upon the completion of this offering; and
- no exercise by the underwriters of their right to purchase up to an additional shares of common stock from us.

None of the information contained in this prospectus has been adjusted to reflect a 1-for- reverse stock split that we intend to effect prior to the completion of this offering.

SUMMARY CONSOLIDATED FINANCIAL DATA

The following table summarizes our consolidated financial data. We have derived the summary consolidated statements of operations data for 2008, 2009 and 2010 from our audited consolidated financial statements included elsewhere in this prospectus. We have derived the summary consolidated statements of operations data for the three months ended March 31, 2010 and 2011 and the consolidated balance sheet data as of March 31, 2011 from our unaudited consolidated financial statements included elsewhere in this prospectus. Our historical results are not necessarily indicative of our results to be expected in any future period, and the results for the three months ended March 31, 2011 are not necessarily indicative of results to be expected for the full year or for any other period. The summary of our consolidated financial data set forth below should be read together with our consolidated financial statements and the related notes, as well as the section entitled "Management's Discussion and Analysis of Financial Condition and Results of Operations," appearing elsewhere in this prospectus.

	Year Ended December 31,			Three Months Ended March 31,	
	2008	2009	2010	2010	2011
(in thousands, except per share data)					
Consolidated Statements of Operations Data:					
Net revenues	\$ 1,668	\$ 20,194	\$ 61,661	\$ 11,587	\$ 18,069
Cost of revenues ⁽¹⁾	7,475	23,223	55,159	10,631	15,421
Gross profit (loss)	(5,807)	(3,029)	6,502	956	2,648
Operating expenses:					
Research and development ⁽¹⁾	5,354	8,411	14,296	2,735	5,345
Sales and marketing ⁽¹⁾	1,809	2,651	6,558	855	3,010
General and administrative ⁽¹⁾	1,727	2,603	6,365	1,099	3,250
Total operating expenses	8,890	13,665	27,219	4,689	11,605
Loss from operations	(14,697)	(16,694)	(20,717)	(3,733)	(8,957)
Other income (expense), net:					
Interest income	206	125	39	10	4
Interest expense	(9)	(356)	(914)	(75)	(280)
Other income (expense)	(1)	—	(185)	(1)	(56)
Total other income (expense), net	196	(231)	(1,060)	(66)	(332)
Net loss	<u>\$ (14,501)</u>	<u>\$ (16,925)</u>	<u>\$ (21,777)</u>	<u>\$ (3,799)</u>	<u>\$ (9,289)</u>
Net loss attributable to common stockholders	<u>\$ (14,501)</u>	<u>\$ (16,925)</u>	<u>\$ (21,777)</u>	<u>\$ (3,799)</u>	<u>\$ (9,289)</u>
Net loss per share attributable to common stockholders, basic and diluted ⁽²⁾	<u>\$ (2.72)</u>	<u>\$ (2.85)</u>	<u>\$ (3.19)</u>	<u>\$ (0.59)</u>	<u>\$ (1.21)</u>
Shares used in computing net loss per share attributable to common stockholders, basic and diluted ⁽²⁾	<u>5,333</u>	<u>5,932</u>	<u>6,829</u>	<u>6,434</u>	<u>7,695</u>
Pro forma net loss per share attributable to common stockholders, basic and diluted ⁽²⁾			<u>\$ (0.10)</u>		<u>\$ (0.04)</u>
Pro forma shares used in computing pro forma net loss per share attributable to common stockholders, basic and diluted ⁽²⁾			<u>216,536</u>		<u>236,248</u>

	As of March 31, 2011	
	Actual	Pro Forma as Adjusted ⁽⁴⁾
	(in thousands)	
Consolidated Balance Sheet Data:		
Cash and cash equivalents	\$30,524	\$30,524
Working capital	30,399	31,353
Total assets	54,834	54,834
Current and long-term debt	8,581	8,581
Convertible preferred stock	93,596	—
Common stock and additional paid-in capital	1,788	96,338
Total stockholders' equity	29,577	30,531

	Year Ended December 31,			Three Months Ended March 31,	
	2008	2009	2010	2010	2011
	(in thousands)				

Other Operating Data:

Microinverter units shipped	11	126	414	74	123
-----------------------------	----	-----	-----	----	-----

(1) Includes stock-based compensation expense as follows (in thousands):

	Year Ended December 31,			Three Months Ended March 31,	
	2008	2009	2010	2010	2011
	Cost of revenues	\$ 4	\$ 17	\$ 9	\$ 1
Research and development	27	62	286	25	140
Sales and marketing	7	36	256	14	137
General and administrative	170	65	278	24	96
Total stock-based compensation expense	\$ 208	\$ 180	\$ 829	\$ 64	\$ 375

- (2) See Note 13 of the notes to our consolidated financial statements for a description of how we compute basic and diluted net loss attributable to common stockholders, basic and diluted net loss per share attributable to common stockholders and pro forma basic and diluted net loss per share attributable to common stockholders.
- (3) Reflects the conversion of all outstanding shares of preferred stock into 228,552,739 shares of common stock and the conversion of outstanding warrants to purchase 1,570,588 shares of preferred stock into warrants to purchase 1,721,988 shares of common stock upon the closing of this offering.
- (4) Reflects the pro forma adjustments described in (3) above and the sale of shares of our common stock by us in this offering at an assumed initial public offering price of \$ per share (which is the midpoint of the price range set forth on the cover page of this prospectus), after deducting the estimated underwriting discounts and commissions and estimated offering expenses payable by us in connection with the offering. A \$1.00 increase or decrease in the assumed initial public offering price of \$ per share of common stock would increase or decrease pro forma cash and cash equivalents by \$ million, working capital by \$ million, total assets by \$ million, common stock and additional paid in capital by \$ million and total stockholders' equity by \$ million, assuming the number of shares offered by us, as set forth on the cover page of this prospectus, remains the same and after deducting the estimated underwriting discounts and commissions and estimated offering expenses payable by us in connection with the offering. The pro forma as adjusted information discussed above is illustrative only and will adjust based on the actual public offering price and other terms of this offering determined at pricing.

RISK FACTORS

You should carefully consider the following risk factors and all other information contained in this prospectus before purchasing our common stock. Investing in our common stock involves a high degree of risk. If any of the following risks actually occurs, we may be unable to conduct our business as currently planned and our financial condition and results of operations could be seriously harmed. In addition, the trading price of our common stock could decline due to the occurrence of any of these risks, and you may lose all or part of your investment. See "Special Note Regarding Forward-Looking Statements and Industry Data" beginning on page 30.

Risks Related to Our Business

We have a history of losses which may continue in the future, and we cannot be certain that we will achieve or sustain profitability.

We have incurred net losses since our inception, we expect to incur net losses in 2011 and we may continue to incur additional net losses in future years as we continue to invest substantial resources to support the growth of our business. We incurred net losses of \$14.5 million, \$16.9 million, \$21.8 million and \$9.3 million in 2008, 2009, 2010 and the three months ended March 31, 2011, respectively. As of March 31, 2011, our accumulated deficit was \$65.8 million. We expect to incur additional costs and expenses related to the continued development and expansion of our business, including in connection with hiring additional personnel, marketing and developing our products, expanding into new product markets and geographies, and maintaining and enhancing our research and development operations. In addition, revenue growth may slow or revenue may decline for a number of possible reasons, many of which are outside our control, including a decline in demand for our offerings, increased competition, a decrease in the growth of the solar industry or our market share, or our failure to continue to capitalize on growth opportunities. If we fail to generate sufficient revenue to support our operations, we may not be able to achieve or sustain profitability.

Our limited operating history makes it difficult to evaluate our current business and future prospects.

We have only been in existence since 2006 and did not begin shipping our products in commercial quantities until mid-2008. Much of our growth has occurred in recent periods. Our limited operating history makes it difficult to evaluate our current business and future prospects. We have encountered and will continue to encounter risks and difficulties frequently experienced by growing companies in rapidly changing industries, including increased expenses as we continue to grow our business. If we do not manage these risks and overcome these difficulties successfully, our business will suffer.

Since we began commercial shipments of our products, our revenue, gross profit and results of operations have varied and are likely to continue to vary from quarter to quarter due to a number of factors, many of which are not within our control. It is difficult for us to accurately forecast our future revenue and gross profit and plan expenses accordingly and, therefore, it is difficult for us to predict our future results of operations.

Further, our efforts to achieve broader market acceptance for our microinverter systems and to expand beyond our existing markets may never succeed, which would adversely impact our ability to generate additional revenue or become profitable.

If demand for solar energy solutions does not continue to grow or grows at a slower rate than we anticipate, our business will suffer.

Our microinverter solution is utilized in solar PV installations, which provide on-site distributed power generation. As a result, our future success depends on continued demand for solar energy solutions and the ability of solar equipment vendors to meet this demand. The solar industry is an evolving industry that has experienced

[Table of Contents](#)

substantial changes in recent years, and we cannot be certain that consumers and businesses will adopt solar PV systems as an alternative energy source at levels sufficient to grow our business. Traditional electricity distribution is based on the regulated industry model whereby businesses and consumers obtain their electricity from a government regulated utility. For alternative methods of distributed power to succeed, businesses and consumers must adopt new purchasing practices. The viability and continued growth in demand for solar energy solutions, and in turn, our products, may be impacted by many factors outside of our control, including:

- market acceptance of solar PV systems based on our product platform;
- cost competitiveness, reliability and performance of solar PV systems compared to conventional and non-solar renewable energy sources and products;
- availability and amount of government subsidies and incentives to support the development and deployment of solar energy solutions;
- the extent to which the electric power industry and broader energy industries are deregulated to permit broader adoption of solar electricity generation;
- the cost and availability of key raw materials and components used in the production of solar PV systems;
- prices of traditional carbon-based energy sources;
- levels of investment by end-users of solar energy products, which tend to decrease when economic growth slows; and
- the emergence, continuance or success of, or increased government support for, other alternative energy generation technologies and products.

If demand for solar energy solutions fails to develop sufficiently, demand for our customers' products as well as demand for our products will decrease, which would have an adverse impact on our ability to increase our revenue and grow our business.

Short-term demand and supply imbalances, especially for solar module technology, recently have caused prices for solar technology solutions to decline rapidly. Furthermore, competition has increased due to the emergence of Asian manufacturers along the entire solar value chain causing further price declines, excess inventory and oversupply. These market disruptions may continue to occur and may increase pressure to reduce prices, which could adversely affect our business and financial results.

The reduction, elimination or expiration of government subsidies and economic incentives for on-grid solar electricity applications could reduce demand for solar PV systems and harm our business.

The market for on-grid applications, where solar power is used to supplement a customer's electricity purchased from the utility network or sold to a utility under tariff, depends in large part on the availability and size of government and economic incentives that vary by geographic market. Because our customers' sales are typically into the on-grid market, the reduction, elimination or expiration of government subsidies and economic incentives for on-grid solar electricity may negatively affect the competitiveness of solar electricity relative to conventional and non-solar renewable sources of electricity, and could harm or halt the growth of the solar electricity industry and our business.

The cost of solar power currently exceeds retail electricity rates, and we believe will continue to do so for the foreseeable future. As a result, federal, state and local government bodies in many countries, most notably Canada, France, Germany, Greece, Italy, Japan, Republic of China, Spain and the United States, have provided incentives in the form of feed-in tariffs, or FiTs, rebates, tax credits and other incentives to system owners, distributors, system integrators and manufacturers of solar PV systems to promote the use of solar electricity in on-grid applications and to reduce dependency on other forms of energy. Many of these government incentives

[Table of Contents](#)

expire, phase out over time, terminate upon the exhaustion of the allocated funding, require renewal by the applicable authority or are being amended by governments due to changing market circumstances or changes to national or local energy policy. For example, Japan's current FiT subsidy program is designed for a duration of 15 years for non-residential solar and 10 years for residential solar. Germany has set FiT cuts depending on GWs forecasted and has recently changed its FiT scheme for 2011 and 2012. France stopped supporting new PV installations in December 2010, but announced a restructuring of the FIT program at the end of February 2011. In addition, electric utility companies or generators of electricity from other non-solar renewable sources of electricity may successfully lobby for changes in the relevant legislation in their markets that are harmful to the solar industry. Reductions in, or eliminations or expirations of, governmental incentives could result in decreased demand for and lower revenue from solar PV systems, which would adversely affect sales of our products. In addition, our ability to successfully penetrate new geographic markets may depend on new countries adopting and maintaining incentives to promote solar electricity, to the extent such incentives are not currently in place.

Our microinverter systems may not achieve broad market acceptance, which would prevent us from increasing our revenue and market share.

If we fail to achieve broad market acceptance of our products, there would be an adverse impact on our ability to increase our revenue, gain market share and achieve and sustain profitability. Our ability to achieve broad market acceptance for our products will be impacted by a number of factors, including:

- our ability to timely introduce and complete new designs and timely qualify and certify our products;
- whether installers and system owners will continue to adopt our microinverter solution, which is a relatively new technology with a limited history with respect to reliability and performance;
- whether installers and system owners will be willing to purchase microinverter systems from us given our limited operating history;
- the ability of prospective system owners to obtain long-term financing for solar PV installations based on our product platform on acceptable terms or at all;
- our ability to produce microinverter systems that compete favorably against other solutions on the basis of price, quality, reliability and performance;
- our ability to develop products that comply with local standards and regulatory requirements, as well as potential in-country manufacturing requirements; and
- our ability to develop and maintain successful relationships with our customers and suppliers.

In addition, our ability to achieve increased market share will depend on our ability to increase sales to established solar installers, who have traditionally sold central inverters. These installers often have made substantial investments in design, installation resources and training in traditional central inverter systems, which may create challenges for us to achieve their adoption of our microinverter solution.

Our gross profit may fluctuate over time, which could impair our ability to achieve or maintain profitability.

Our gross profit has varied in the past and is likely to continue to vary significantly from period to period. Our gross profit may be adversely affected by numerous factors, some of which are beyond our control, including:

- changes in customer, geographic or product mix;
- increased price competition, including the impact of customer discounts and rebates;
- our ability to reduce and control product costs;

[Table of Contents](#)

- loss of cost savings due to changes in component or raw material pricing or charges incurred due to inventory holding periods if product demand is not correctly anticipated;
- introduction of new products;
- price reductions on older generation products to sell remaining inventory;
- our ability to reduce production costs, such as through technology innovations, in order to offset price declines in older products over time;
- changes in shipment volume;
- changes in distribution channels;
- increased warranty costs and reserves;
- excess and obsolete inventory and inventory holding charges; and
- expediting costs incurred to meet customer delivery requirements.

Fluctuations in gross profit may adversely affect our ability to manage our business or achieve or maintain profitability.

The inverter industry is highly competitive and we expect to face increased competition as new and existing competitors introduce microinverter products, which could negatively impact our results of operations and market share.

To date, we have competed primarily against central inverter manufacturers and have faced almost no direct competition in selling our microinverter systems. Marketing and selling our microinverter solutions against traditional inverter solutions is highly competitive, and we expect competition to intensify as new and existing competitors enter the microinverter market. We believe that a number of companies have developed or are developing microinverters and other products that will compete directly with our microinverter systems.

Currently, competitors in the inverter market range from large companies such as SMA Solar Technology AG, Fronius International GmbH and Power-One Inc. to emerging companies offering alternative microinverter or other solar electronics products. Some of our competitors have announced plans to introduce microinverter products that could compete with our microinverter systems. Several of our existing and potential competitors are significantly larger, have greater financial, marketing, distribution, customer support and other resources, are more established than we are, and have significantly better brand recognition. Some of our competitors have more resources to develop or acquire, and more experience in developing or acquiring, new products and technologies and in creating market awareness for these products and technologies. Further, certain competitors may be able to develop new products more quickly than us and may be able to develop products that are more reliable or which provide more functionality than ours. In addition, some of our competitors have the financial resources to offer competitive products at aggressive or below-market pricing levels, which could cause us to lose sales or market share or require us to lower prices for our microinverter systems in order to compete effectively. If we have to reduce our prices by more than we anticipated, or if we are unable to offset any future reductions in our average selling prices by increasing our sales volume, reducing our costs and expenses or introducing new products, our gross profit would suffer.

We also may face competition from some of our customers who evaluate our capabilities against the merits of manufacturing products internally. For instance, solar module manufacturers could attempt to develop components that directly perform DC to AC conversion in the module itself. Due to the fact that such customers may not seek to make a profit directly from the manufacture of these products, they may have the ability to manufacture competitive products at a lower cost than we would charge such customers. As a result, these customers may purchase fewer of our microinverter systems or sell products that compete with our microinverters systems, which would negatively impact our revenue and gross profit.

If we are unable to effectively manage our growth, our business and operating results may suffer.

We have recently experienced, and expect to continue to experience, significant growth in our sales and operations. Our historical growth has placed, and planned future growth is expected to continue to place, significant demands on our management, as well as our financial and operational resources, to:

- manage a larger organization;
- expand third-party manufacturing, testing and distribution capacity;
- build additional custom manufacturing test equipment;
- manage an increasing number of relationships with customers, suppliers and other third parties;
- increase our sales and marketing efforts;
- train and manage a growing employee base;
- broaden our customer support capabilities;
- implement new and upgrade existing operational and financial systems; and
- enhance our financial disclosure controls and procedures.

We cannot assure you that our current and planned operations, personnel, systems, internal procedures and controls will be adequate to support our future growth. If we cannot manage our growth effectively, we may be unable to take advantage of market opportunities, execute our business strategies or respond to competitive pressures, any of which could have a material adverse effect on our financial condition, results of operation, business or prospects.

Our planned expansion into new markets could subject us to additional business, financial and competitive risks.

We currently offer microinverter systems targeting the North American residential and commercial markets. However, we intend to introduce new microinverter systems targeted at larger commercial and utility-scale installations and to expand into international markets. Our success in these new product and geographic markets will depend on a number of factors, such as:

- timely qualification and certification of new products for larger commercial and utility-scale installations;
- acceptance of microinverters in markets in which they have not traditionally been used;
- our ability to compete in new product markets to which we are not accustomed;
- our ability to manage an increasing manufacturing capacity and production;
- willingness of our potential customers to incur a higher upfront capital investment than may be required for competing solutions;
- our ability to reduce production costs in order to price our products competitively over time;
- accurate forecasting and effective management of inventory levels in line with anticipated product demand; and
- our customer service capabilities and responsiveness.

Further, new geographic markets and the larger commercial and utility-scale installation markets have different characteristics from the markets in which we currently sell products, and our success will depend on our ability to properly address these differences. These differences may include:

- differing regulatory requirements, including tax laws, trade laws, labor regulations, tariffs, export quotas, customs duties or other trade restrictions;
- limited or unfavorable intellectual property protection;

Table of Contents

- risk of change in international political or economic conditions;
- restrictions on the repatriation of earnings;
- fluctuations in the value of foreign currencies and interest rates;
- difficulties and increased expenses in complying with a variety of U.S. and foreign laws, regulations and trade standards, including the Foreign Corrupt Practices Act;
- potentially longer sales cycles;
- higher volume requirements;
- increased customer concentrations;
- warranty expectations and product return policies; and
- cost, performance and compatibility requirements.

Failure to develop and introduce these new products successfully, to generate sufficient revenue from these products to offset associated research and development, marketing and manufacturing costs, or to otherwise effectively anticipate and manage the risks and challenges associated with our potential expansion into new product and geographic markets, could adversely affect our revenues and our ability to achieve or sustain profitability.

A drop in the retail price of electricity derived from the utility grid or from alternative energy sources may harm our business, financial condition and results of operations.

We believe that a system owner's decision to purchase a solar PV system is strongly influenced by the cost of electricity generated by solar PV installations relative to the retail price of electricity from the utility grid and the cost of other renewable energy sources, including electricity from solar PV installations using central inverters. Decreases in the retail prices of electricity from the utility grid would make it more difficult for all solar PV systems to compete. In particular, growth in unconventional natural gas production and an increase in global liquefied natural gas capacity are expected to keep natural gas prices relatively low for the foreseeable future. Persistent low natural gas prices, lower prices of electricity produced from other energy sources, such as nuclear power, or improvements to the utility infrastructure could reduce the retail price of electricity from the utility grid, making the purchase of solar PV systems less economically attractive and lowering sales of our microinverter systems. In addition, energy conservation technologies and public initiatives to reduce demand for electricity also could cause a fall in the retail price of electricity from the utility grid. Moreover, technological developments by our competitors in the solar components industry, including manufacturers of central inverters, could allow these competitors or their partners to offer electricity at costs lower than those that can be achieved from solar PV installations based on our product platform, which could result in reduced demand for our products. If the cost of electricity generated by solar PV installations incorporating our microinverter systems is high relative to the cost of electricity from other sources, our business, financial condition and results of operations may be harmed.

Problems with product quality or product performance may cause us to incur warranty expenses and may damage our market reputation and cause our revenue to decline.

We have offered 15-year limited warranties for our first and second generation microinverters and offer a 25-year limited warranty on our third generation microinverters. Our limited warranties cover defects in materials and workmanship of our microinverters under normal use and service conditions for up to 25 years following installation. As a result, we bear the risk of warranty claims long after we have shipped product and recognized revenue. Our estimated costs of warranty for previously shipped products may change to the extent future products are not compatible with earlier generation products under warranty.

[Table of Contents](#)

While we offer 15 or 25-year warranties, our microinverters have only been in use since mid-2008, when we first commenced commercial sales of our products. Although we conduct accelerated life cycle testing to measure performance and reliability, our microinverter systems have not been tested over the full warranty cycle and do not have a sufficient operating history to confirm how they will perform over their estimated useful life. In addition, under real-world operating conditions, which may vary by location and design, as well as insolation, soiling and weather conditions, a typical solar PV installation may perform in a different way than under standard test conditions. If our products perform below expectations or have unexpected reliability problems, we may be unable to gain or retain customers and could face substantial warranty expense. In addition, any widespread product failures may damage our market reputation and cause us to lose customers.

Because of the limited operating history of our products, we have been required to make assumptions and apply judgments, based on our accelerated life cycle testing, regarding a number of factors, including our anticipated rate of warranty claims and the durability and reliability of our products. Our assumptions could prove to be materially different from the actual performance of our products, causing us to incur substantial expense to repair or replace defective products in the future. An increase in our estimates of future warranty obligations due to product failure rates, shipment volumes, field service obligations and rework costs incurred in correcting product failures, could cause us to increase the amount of warranty reserves and have a corresponding negative impact on our results of operations.

If we do not forecast demand for our products accurately, we may experience product shortages, delays in product shipment, excess product inventory, or difficulties in planning expenses, which will adversely affect our business and financial condition.

We manufacture our products according to our estimates of customer demand. This process requires us to make multiple forecasts and assumptions relating to the demand of our distributors, their end customers and general market conditions. Because we sell most of our products to distributors, who in turn sell to their end customers, we have limited visibility as to end-customer demand. We depend significantly on our distributors to provide us visibility into their end customer demand, and we use these forecasts to make our own forecasts and planning decisions. If the information from our distributors turns out to be incorrect, then our own forecasts may also be inaccurate. Furthermore, we do not have long-term purchase commitments from our distributors or end customers, and our sales are generally made by purchase orders that may be cancelled, changed or deferred without notice to us or penalty. As a result, it is difficult to forecast future customer demand to plan our operations.

If we overestimate demand for our products, or if purchase orders are cancelled or shipments are delayed, we may have excess inventory that we cannot sell. Historically, provisions for write-downs of inventories have not been significant. In the future we may have to make significant provisions for inventory write-downs based on events that are currently not known, and such provisions or any adjustments to such provisions could be material. Conversely, if we underestimate demand, we may not have sufficient inventory to meet end-customer demand, and we may lose market share, damage relationships with our distributors and end customers and forego potential revenue opportunities. Obtaining additional supply in the face of product shortages may be costly or impossible, particularly in the short term and in light of our outsourced manufacturing processes, which could prevent us from fulfilling orders in a timely and cost efficient manner or at all. In addition, if we overestimate our production requirements, our contract manufacturers may purchase excess components and build excess inventory. If our contract manufacturers, at our request, purchase excess components that are unique to our products and are unable to recoup the costs of such excess through resale or return or build excess products, we could be required to pay for these excess parts or products and recognize related inventory write-downs.

In addition, we plan our operating expenses, including research and development expenses, hiring needs and inventory investments, in part on our estimates of customer demand and future revenue. If customer demand or revenue for a particular period is lower than we expect, we may not be able to proportionately reduce our fixed operating expenses for that period, which would harm our operating results for that period.

We depend upon a small number of outside contract manufacturers. Our operations could be disrupted if we encounter problems with these contract manufacturers.

We do not have internal manufacturing capabilities, and rely upon a small number of contract manufacturers to build our products. In particular, we rely on contract manufacturers for the manufacture of microinverter products, cabling and our communications gateway related to our microinverter systems. Our reliance on a small number of contract manufacturers makes us vulnerable to possible capacity constraints and reduced control over component availability, delivery schedules, manufacturing yields and costs. We do not have long-term supply contracts with our other manufacturing partners. Consequently, these manufacturers are not obligated to supply products to us for any period, in any specified quantity or at any certain price.

The revenues that our contract manufacturers generate from our orders represent a relatively small percentage of their overall revenues. As a result, fulfilling our orders may not be considered a priority in the event of constrained ability to fulfill all of their customer obligations in a timely manner. In addition, the facilities in which our microinverters, related cabling and communications gateway products are manufactured are located outside of the United States. We believe that the location of these facilities outside of the United States increases supply risk, including the risk of supply interruptions or reductions in manufacturing quality or controls.

If any of our contract manufacturers were unable or unwilling to manufacture our products in required volumes and at high quality levels or renew existing terms under supply agreements, we would have to identify, qualify and select acceptable alternative contract manufacturers. An alternative contract manufacturer may not be available to us when needed or may not be in a position to satisfy our quality or production requirements on commercially reasonable terms, including price. Any significant interruption in manufacturing would require us to reduce our supply of products to our customers, which in turn would reduce our revenues, harm our relationships with our customers and damage our relationships with our distributors and end customers and cause us to forego potential revenue opportunities.

Manufacturing problems could result in delays in product shipments to customers and could adversely affect our revenue, competitive position and reputation.

We may experience delays, disruptions or quality control problems in our manufacturing operations. Our product development, manufacturing and testing processes are complex and require significant technological and production process expertise. Such processes involve a number of precise steps from design to production. Any change in our processes could cause one or more production errors, requiring a temporary suspension or delay in our production line until the errors can be researched, identified and properly addressed and rectified. This may occur particularly as we introduce new products, modify our engineering and production techniques, and/or expand our capacity. In addition, our failure to maintain appropriate quality assurance processes could result in increased product failures, loss of customers, increased production costs and delays. Any of these developments could have a material adverse effect on our business, financial condition, and results of operations.

A disruption could also occur in our manufacturing partner's fabrication facility due to any number of reasons, such as equipment failure, contaminated materials or process deviations, which could adversely impact manufacturing yields or delay product shipments. As a result, we could incur additional costs that would adversely affect our gross profit, and product shipments to our customers could be delayed beyond the shipment schedules requested by our customers, which would negatively affect our revenue, competitive position and reputation.

Additionally, manufacturing yields depend on a number of factors, including the stability and manufacturability of the product design, manufacturing improvements gained over cumulative production volumes and the quality and consistency of component parts. Capacity constraints, raw materials shortages,

[Table of Contents](#)

logistics issues, labor shortages, changes in customer requirements, manufacturing facilities or processes, or those of some third-party contract manufacturers and suppliers of raw materials and components have historically caused, and may in the future cause, reduced manufacturing yields, negatively impacting the gross profit on, and our production capacity for, those products. Moreover, an increase in the rejection and rework rate of products during the quality control process before, during or after manufacture would result in our experiencing lower yields, gross profit and production capacity.

The risks of these types of manufacturing problems are further increased during the introduction of new product lines, which has from time to time caused, and may in the future cause, temporary suspension of production lines while problems are addressed or corrected. Since our business is substantially dependent on a limited number of product lines, any prolonged or substantial suspension of manufacturing production lines could result in a material adverse effect on our revenue, gross profit, competitive position, and distributor and customer relationships.

We depend on sole source and limited source suppliers for key components and products. If we are unable to source these components on a timely basis, we will not be able to deliver our products to our customers.

We depend on sole source and limited source suppliers for key components of our products. For example, our ASICs are purchased from a sole source supplier or developed for us by sole source suppliers. Any of the sole source and limited source suppliers upon whom we rely could stop producing our components, cease operations or be acquired by, or enter into exclusive arrangements with, our competitors. We generally do not have long-term supply agreements with our suppliers, and our purchase volumes are currently too low for us to be considered a priority customer by most of our suppliers. As a result, most of these suppliers could stop selling to us at commercially reasonable prices, or at all. Any such interruption or delay may force us to seek similar components or products from alternative sources, which may not be available on commercially reasonable terms, including price, or at all. Switching suppliers may require that we redesign our products to accommodate new components, and may potentially require us to re-qualify our products, which would be costly and time-consuming. Any interruption in the supply of sole source or limited source components for our products would adversely affect our ability to meet scheduled product deliveries to our customers, could result in lost revenue or higher expenses and would harm our business.

If we or our contract manufacturers are unable to obtain raw materials in a timely manner or if the price of raw materials increases significantly, production time and product costs could increase, which may adversely affect our business.

The manufacturing and packaging processes used by our contract manufacturers depend on raw materials such as copper, aluminum, silicon and petroleum-based products. From time to time, suppliers may extend lead times, limit supplies or increase prices due to capacity constraints or other factors. Certain of our suppliers have the ability to pass along to us directly or through our contract manufacturers any increases in the price of raw materials. If the prices of these raw materials rise significantly, we may be unable to pass on the increased cost to our customers. While we may from time to time enter into hedging transactions to reduce our exposure to wide fluctuations in the cost of raw materials, the availability and effectiveness of these hedging transactions may be limited. Due to all these factors, our results of operations could be adversely affected if we or our contract manufacturers are unable to obtain adequate supplies of raw materials in a timely manner or at reasonable cost. In addition, from time to time, we or our contract manufacturers may need to reject raw materials that do not meet our specifications, resulting in potential delays or declines in output. Furthermore, problems with our raw materials may give rise to compatibility or performance issues in our products, which could lead to an increase in customer returns or product warranty claims. Errors or defects may arise from raw materials supplied by third parties that are beyond our detection or control, which could lead to additional customer returns or product warranty claims that may adversely affect our business and results of operations.

If potential owners of solar PV systems based on our product platform are unable to secure financing on acceptable terms, we could experience a reduction in the demand for our solar PV systems.

Many owners of solar PV systems depend on financing to purchase their systems. The limited use of microinverters to date, coupled with our limited operating history, could result in lenders refusing to provide the financing necessary to purchase solar PV systems based on our product platform on favorable terms, or at all. Moreover, in the case of debt financed projects, even if lenders are willing to finance the purchase of these systems, an increase in interest rates or a change in tax incentives could make it difficult for owners to secure the financing necessary to purchase a solar PV system on favorable terms, or at all. In addition, we believe that a significant percentage of owners purchase solar PV systems as an investment, funding the initial capital expenditure through a combination of upfront cash and financing. Difficulties in obtaining financing for solar PV installations on favorable terms, or increases in interest rates or changes in tax incentives, could lower an investor's return on investment in a solar PV installation, or make alternative solar PV systems or other investments more attractive relative to solar PV systems based on our product platform. Any of these events could result in reduced demand for our products, which could have a material adverse effect on our financial condition and results of operations.

We rely primarily on distributors to assist in selling our products, and the failure of these distributors to perform as expected could reduce our future revenue.

We sell our microinverter systems primarily through distributors, as well as through direct sales to solar equipment installers. Two distributors collectively accounted for 25% of our total revenues for 2010, one of which was also our largest distributor for the three months ended March 31, 2011, representing approximately 17% of our total revenues. We do not have exclusive arrangements with these third parties and, as a result, many of our distributors also market and sell products from our competitors, which may reduce our sales. Our distributors may terminate their relationships with us at any time, or with short notice. Our distributors may fail to devote resources necessary to sell our products at the prices, in the volumes and within the time frames that we expect, or may focus their marketing and sales efforts on products of our competitors. Our future performance depends on our ability to effectively manage our relationships with our existing distributors, as well as to attract additional distributors that will be able to market and support our products effectively, especially in markets in which we have not previously distributed our products. Termination of agreements with current distributors, failure by these distributors to perform as expected, or failure by us to cultivate new distributor relationships, could hinder our ability to expand our operations and harm our revenue and operating results.

Ordering patterns from our distributors may cause our revenue to fluctuate significantly from period to period.

Our distributors place purchase orders with us based on their assessment of end-customer demand and their forecasts. Because these forecasts may not be accurate, channel inventory held at our distributors may fluctuate significantly due to the difference between their forecasts and actual demand. As a result, distributors adjust their purchase orders placed with us in response to changing channel inventory levels, as well as their assessment of the latest market demand trends. We have limited visibility into future end customer demand. A significant decrease in our distributors' channel inventory in one period may lead to a significant rebuilding of channel inventory in subsequent periods, or vice versa, which may cause our quarterly revenue and operating results to fluctuate significantly. This fluctuation may cause our results to fall short of analyst or investor expectations in a certain period, which may cause our stock price to decline.

Our success in an "AC module" version of our microinverter system may depend in part upon our ability to continue to work closely with leading solar module manufacturers.

We are currently working on a variant of our microinverter system that will enable an "AC module" for direct attachment of the microinverter to the backsheet of the solar modules. The market success of such solutions will depend in part on our ability to continue to work closely with solar module manufacturers to design

[Table of Contents](#)

solar modules that are compatible with such direct attachment microinverter solutions. We may not be able to encourage solar module manufacturers to work with us on the development of such compatible solutions combining our microinverter system and solar modules for a variety of reasons, including differences in marketing or selling strategy, competitive considerations, lack of competitive pricing, and technological compatibility.

If we fail to retain our key personnel or if we fail to attract additional qualified personnel, we may not be able to achieve our anticipated level of growth and our business could suffer.

Our future success and ability to implement our business strategy depends, in part, on our ability to attract and retain key personnel, and on the continued contributions of members of our senior management team and key technical personnel, each of whom would be difficult to replace. All of our employees, including our senior management, are free to terminate their employment relationships with us at any time. Competition for highly skilled technical people is extremely intense, and we face challenges identifying, hiring and retaining qualified personnel in many areas of our business. If we fail to retain our senior management and other key personnel or if we fail to attract additional qualified personnel, we may not be able to achieve our strategic objectives and our business could suffer.

If we fail to protect, or incur significant costs in defending, our intellectual property and other proprietary rights, our business and results of operations could be materially harmed.

Our success depends to a significant degree on our ability to protect our intellectual property and other proprietary rights. We rely on a combination of patent, trademark, copyright, trade secret and unfair competition laws, as well as confidentiality and license agreements and other contractual provisions, to establish and protect our intellectual property and other proprietary rights. We have applied for patent and trademark registrations in the United States and in certain other countries, some of which have been issued. We cannot guarantee that any of our pending applications will be approved or that our existing and future intellectual property rights will be sufficiently broad to protect our proprietary technology, and any failure to obtain such approvals or finding that our intellectual property rights are invalid or unenforceable could force us to, among other things, rebrand or re-design our affected products. In countries where we have not applied for patent protection or where effective intellectual property protection is not available to the same extent as in the United States, we may be at greater risk that our proprietary rights will be misappropriated, infringed or otherwise violated.

To protect our unregistered intellectual property, including our trade secrets and know-how, we rely in part on trade secret laws and confidentiality and invention assignment agreements with our employees and independent consultants. We also require other third parties who may have access to our proprietary technologies and information to enter into non-disclosure agreements. Such measures, however, provide only limited protection, and we cannot assure that our confidentiality and non-disclosure agreements will prevent unauthorized disclosure or use of our confidential information, especially after our employees or third parties end their employment or engagement with us, or provide us with an adequate remedy in the event of such disclosure. Furthermore, competitors or other third parties may independently discover our trade secrets, in which case we would not be able to assert trade secret rights, copy or reverse engineer our products or portions thereof or develop similar technology. If we fail to protect our intellectual property and other proprietary rights, or if such intellectual property and proprietary rights are infringed, misappropriated or otherwise violated, our business, results of operations or financial condition could be materially harmed.

In the future, we may need to take legal action to prevent third parties from infringing upon or misappropriating our intellectual property or from otherwise gaining access to our technology. Protecting and enforcing our intellectual property rights and determining their validity and scope could result in significant litigation costs and require significant time and attention from our technical and management personnel, which could significantly harm our business. In addition, we may not prevail in such proceedings. An adverse outcome of any such proceeding may reduce our competitive advantage or otherwise harm our financial condition and our business.

Third parties may assert that we are infringing upon their intellectual property rights, which could divert management's attention, cause us to incur significant costs and prevent us from selling or using the technology to which such rights relate.

Our competitors and other third parties hold numerous patents related to technology used in our industry, and claims of patent or other intellectual property right infringement or violation have been litigated against certain of our competitors. From time to time we may also be subject to such claims and litigation. Regardless of their merit, responding to such claims can be time consuming, divert management's attention and resources and may cause us to incur significant expenses. While we believe that our products and technology do not infringe in any material respect upon any valid intellectual property rights of third parties, we cannot be certain that we would be successful in defending against any such claims. Furthermore, patent applications in the United States and most other countries are confidential for a period of time before being published, so we cannot be certain that we are not infringing third parties' patent rights or that we were the first to conceive inventions covered by our patents or patent applications. As we become more visible as a publicly traded company, the possibility that third parties may make claims of intellectual property infringement or other violations against us may grow. An adverse outcome with respect to any such claim could invalidate our proprietary rights and force us to do one or more of the following:

- obtain from a third party claiming infringement a license to sell or use the relevant technology, which may not be available on reasonable terms, or at all;
- stop manufacturing, selling, incorporating or using our products that embody the asserted intellectual property;
- pay substantial monetary damages;
- indemnify our customers pursuant to indemnification obligations under some of our customer contracts; or
- expend significant resources to redesign the products that use the infringing technology and to develop or acquire non-infringing technology.

Any of these actions could result in a substantial reduction in our revenue and could result in losses over an extended period of time.

Our failure to obtain the right to use necessary third-party intellectual property rights on reasonable terms, or our failure to maintain, and comply with the terms and conditions applicable to, these rights, could harm our business and prospects.

From time to time we have licensed, and in the future we may choose to or be required to license, technology or intellectual property from third parties in connection with the development of our products. We cannot assure that such licenses will be available to us on commercially reasonable terms, or at all, and our inability to obtain such licenses could require us to substitute technology of lower quality or of greater cost. In addition, we incorporate open source software code in our proprietary software. Use of open source software can lead to greater risks than use of third-party commercial software since open source licensors generally do not provide warranties or controls with respect to origin, functionality or other features of the software. Some open source software licenses require users who distribute open source software as part of their products to publicly disclose all or part of the source code in their software and make any derivative works of the open source code available for limited fees or at no cost. Although we monitor our use of open source software, open source license terms may be ambiguous, and many of the risks associated with the use of open source software cannot be eliminated. If we were found to have inappropriately used open source software, we may be required to release our proprietary source code, re-engineer our software, discontinue the sale of certain products in the event re-engineering cannot be accomplished on a timely basis or take other remedial action. Furthermore, if we are unable to obtain or maintain licenses from third parties or fail to comply with applicable open source licenses, we may be subject to costly third party claims of intellectual property infringement or ownership of our proprietary source code. Any of the foregoing could harm our business and put us at a competitive disadvantage.

Defects and poor performance in our products could result in loss of customers, decreased revenue and unexpected expenses, and we may face warranty and product liability claims arising from defective products.

Our products must meet stringent quality requirements and may contain undetected errors or defects, especially when first introduced or when new generations are released. Errors, defects or poor performance can arise due to design flaws, defects in raw materials or components or manufacturing difficulties, which can affect both the quality and the yield of the product. These errors or defects may be dangerous, as defective power components may cause power overloads, potentially resulting in explosion or fire. As we develop new generations of our products and enter new markets, we face higher risk of undetected defects, because our testing protocols may not be able to fully test the products under all possible operating conditions. In the past, we have experienced defects in our products due to certain errors in the manufacturing and design process. Any actual or perceived errors, defects or poor performance in our products could result in the replacement or recall of our products, shipment delays, rejection of our products, damage to our reputation, lost revenue, diversion of our engineering personnel from our product development efforts in order to address or remedy any defects and increases in customer service and support costs, all of which could have a material adverse effect on our business and operations.

Furthermore, defective, inefficient or poorly performing power components may give rise to warranty and product liability claims against us that exceed any revenue or profit we receive from the affected products. We could incur significant costs and liabilities if we are sued and if damages are awarded against us. We currently maintain a moderate level of product liability insurance, and there can be no assurance that this insurance will provide sufficient coverage in the event of a claim. Also, we cannot predict whether we will be able to maintain this coverage on acceptable terms, if at all, or that a product liability claim would not harm our business or financial condition. Costs or payments we may make in connection with warranty and product liability claims or product recalls may adversely affect our financial condition and results of operations.

Our Enlighten web-based monitoring service, which our customers use to track and monitor the performance of their solar PV systems based on our product platform, may contain undetected errors, failures, or bugs, especially when new versions or enhancements are released. We have from time to time found defects in our service and new errors in our existing service may be detected in the future. Any errors, defects, disruptions in service or other performance problems with our monitoring service could harm our reputation and may damage our customers' businesses.

Our business has been and could continue to be affected by seasonal trends and construction cycles.

We have been and could continue to be subject to industry-specific seasonal fluctuations in the future, particularly in climates that experience colder weather during the winter months, such as northern Europe, Canada, and the United States. In general, we expect our product revenue in the third and fourth quarters to be positively affected by seasonal customer demand trends, including solar economic incentives, weather patterns and construction cycles. In the United States, customers will sometimes make purchasing decisions towards the end of the year in order to take advantage of tax credits or for budgetary reasons. In addition, construction levels are typically slower in colder months. In European countries with FiTs, the construction of solar PV systems may be concentrated during the second half of the calendar year, largely due to the annual reduction of the applicable minimum FiT and the fact that the coldest winter months are January through March. Accordingly, our business and quarterly results of operations could be affected by seasonal fluctuations in the future.

Covenants in our credit facilities may limit our flexibility in responding to business opportunities and competitive developments and increase our vulnerability to adverse economic or industry conditions.

We have lending arrangements with several financial institutions, including loan and security agreements with Comerica Bank and Bridge Bank, National Association, with Horizon Technology Finance Corporation, and with Hercules Technology Growth Capital, Inc., as well as a junior convertible loan facility with certain of our

[Table of Contents](#)

existing preferred shareholders. The loan and security agreements with Comerica Bank and Bridge Bank, with Horizon Technology Finance, with Hercules, and with the lenders under our junior convertible loan facility, all restrict our ability to take certain actions such as incurring additional debt, encumbering our tangible or intangible property, paying dividends, or engaging in certain transactions, such as mergers and acquisitions, investments and asset sales. Our loan and security agreement with Bridge Bank and Comerica Bank also requires us to maintain certain financial covenants, including liquidity and tangible net worth ratios. These restrictions may limit our flexibility in responding to business opportunities, competitive developments and adverse economic or industry conditions. In addition, our obligations under our loan and security agreements with Bridge Bank and Comerica Bank, Horizon Technology Finance, as well as for our junior convertible loan facility, are secured by substantially all of our assets (excluding intellectual property), which limits our ability to provide collateral for additional financing. A breach of any of these covenants, or a failure to pay interest or indebtedness when due under any of our credit facilities, could result in a variety of adverse consequences, including the acceleration of our indebtedness and the forfeiture of our assets subject to security interests in favor of the lenders.

If we fail to maintain an effective system of internal controls or are unable to remediate any deficiencies in our internal controls, we might not be able to report our financial results accurately or prevent fraud; in that case, our stockholders could lose confidence in our financial reporting, which would harm our business and could negatively impact the price of our stock.

Effective internal controls are necessary for us to provide reliable financial reports and prevent fraud. In addition, Section 404 of the Sarbanes-Oxley Act of 2002, or the Sarbanes-Oxley Act, will require us and potentially our independent registered public accounting firm to evaluate and report on our internal control over financial reporting beginning with our Annual Report on Form 10-K for the year ending December 31, 2012. The process of implementing our internal controls and complying with Section 404 will be expensive and time consuming, and will require significant attention of management. We cannot be certain that these measures will ensure that we implement and maintain adequate controls over our financial processes and reporting in the future. Even if we conclude, and our independent registered public accounting firm concurs, that our internal control over financial reporting provides reasonable assurance regarding the reliability of financial reporting and the preparation of financial statements for external purposes in accordance with generally accepted accounting principles, because of its inherent limitations, internal control over financial reporting may not prevent or detect fraud or misstatements. Failure to implement required new or improved controls, or difficulties encountered in their implementation, could harm our results of operations or cause us to fail to meet our reporting obligations. If we or our independent registered public accounting firm discover a material weakness, the disclosure of that fact, even if quickly remedied, could reduce the market's confidence in our financial statements and harm our stock price. In addition, a delay in compliance with Section 404 could subject us to a variety of administrative sanctions, including SEC action, ineligibility for short form resale registration, the suspension or delisting of our common stock from the stock exchange on which it is listed and the inability of registered broker-dealers to make a market in our common stock, which would further reduce our stock price and could harm our business.

With respect to 2010, we and our independent registered public accounting firm identified significant deficiencies in our internal controls over financial reporting but these deficiencies did not create a material weakness. The significant deficiencies related to our need for continued improvements in the: (i) quality and quantity of accounting resources, (ii) closing process and preparation and review of financial statements every reporting period, and (iii) documentation of accounting policies and procedures and segregation of duties. We have made efforts to remediate these significant deficiencies through hiring additional experienced accounting personnel and engaging external resources to assist in internal control remediation efforts. If significant deficiencies in our internal controls are not fully remediated or if additional significant deficiencies are identified, those significant deficiencies could lead to material weaknesses in the future, potentially causing us to fail to meet our future reporting obligations and the price of our common stock to decline.

Our ability to use net operating losses to reduce future tax payments may be limited by provisions of the Internal Revenue Code, and may be subject to further limitation as a result of future transactions.

Sections 382 and 383 of the Internal Revenue Code of 1986, as amended, contain rules that limit the ability of a company that undergoes an ownership change, which is generally any cumulative change in ownership of more than 50% of its stock over a three-year period, to utilize its net operating loss and tax credit carryforwards and certain built-in losses recognized in the years after the ownership change. These rules generally operate by focusing on ownership changes involving stockholders who directly or indirectly own 5% or more of the stock of a company and any change in ownership arising from a new issuance of stock by the company. Generally, if an ownership change occurs, the yearly taxable income limitation on the use of net operating loss and tax credit carryforwards is equal to the product of the applicable long-term tax exempt rate and the value of the company's stock immediately before the ownership change. As a result, we may be unable to offset our taxable income with net operating losses, or our tax liability with credits, before these losses and credits expire.

In addition, it is possible that future transactions (including issuances of new shares of our common stock and sales of shares of our common stock) will cause us to undergo one or more additional ownership changes. In that event, we generally would not be able to use our net operating losses from periods prior to this ownership change to offset future taxable income in excess of the annual limitations imposed by Sections 382 and 383 and those attributes that are already subject to limitations (as a result of our prior ownership changes) may be subject to more stringent limitations.

We will incur increased costs as a result of operating as a public company, and our management will be required to devote substantial time to new compliance initiatives.

As a public company, we will incur legal, accounting and other expenses that we did not incur as a private company. The Dodd-Frank Wall Street Reform and Consumer Protection Act, or the Dodd-Frank Act, the Sarbanes-Oxley Act and the rules implemented by the SEC and the NASDAQ Global Market impose significant regulatory requirements on public companies, including specific corporate governance practices. For example, the listing requirements of the NASDAQ Global Market require that we satisfy certain corporate governance requirements relating to independent directors, audit and compensation committees, distribution of annual and interim reports, stockholder meetings, stockholder approvals, solicitation of proxies, conflicts of interest, stockholder voting rights and codes of conduct. Our management and other personnel will need to devote a substantial amount of time to these compliance initiatives. Moreover, these rules and regulations will increase our legal and financial compliance costs and will make some activities more time-consuming and costly. For example, we expect these rules and regulations to make it more difficult and more expensive for us to obtain director and officer liability insurance, and we may be required to accept reduced policy limits and coverage or incur substantial additional costs to maintain the same or similar coverage. These rules and regulations could also make it more difficult for us to attract and retain qualified persons to serve on our board of directors, our board committees or as executive officers.

These rules and regulations also contain requirements that apply to manufacturers of products incorporating specified minerals. The Dodd-Frank Act requires public companies to report on their use of so-called conflict minerals originating from the Democratic Republic of Congo or its nine immediate neighbors. Certain minerals commonly used in semiconductors are on the list of conflict minerals, and additional minerals may be added to the list in the future. Compliance with these rules, which will require us to disclose our use of these minerals and to obtain an annual audit of our sourcing and the chain of custody of these minerals, will be time-consuming and costly.

[Table of Contents](#)

We may not be able to raise additional capital to execute on our current or future business opportunities on favorable terms, if at all, or without dilution to our stockholders.

We believe that our existing cash and cash equivalents, excluding any proceeds from this offering, available credit facilities and cash flows from our operating activities, will be sufficient to meet our anticipated cash needs for at least the next 12 months. However, we expect that ultimately we may need to raise additional capital to execute on our current or future business strategies, including to:

- invest in our research and development efforts by hiring additional technical and other personnel;
- expand our operations into new product markets and new geographies;
- acquire complementary businesses, products, services or technologies; or
- otherwise pursue our strategic plans and respond to competitive pressures.

We do not know what forms of financing, if any, will be available to us for this planned expansion. If financing is not available on acceptable terms, if and when needed, our ability to fund our operations, expand our research and development, sales and marketing functions, develop and enhance our products, respond to unanticipated events, including unanticipated opportunities, or otherwise respond to competitive pressures would be significantly limited. In any such event, our business, financial condition and results of operations could be materially harmed, and we may be unable to continue our operations. Moreover, if we raise additional funds through the issuance of equity or convertible debt securities, the percentage ownership of our stockholders could be significantly diluted, and these newly issued securities may have rights, preferences or privileges senior to those of existing stockholders, including those acquiring shares in this offering.

Natural disasters, terrorist attacks or other catastrophic events could harm our operations.

Our worldwide operations could be subject to natural disasters and other business disruptions, which could harm our future revenue and financial condition and increase our costs and expenses. For example, our corporate headquarters in Petaluma, California is located near major earthquake fault lines. Further, a terrorist attack, including one aimed at energy or communications infrastructure suppliers, could hinder or delay the development and sale of our products. In the event that an earthquake, tsunami, typhoon, terrorist attack or other natural, manmade or technical catastrophe were to destroy any part of our facilities or those of our contract manufacturer, destroy or disrupt vital infrastructure systems or interrupt our operations for any extended period of time, our business, financial condition and results of operations would be materially adversely affected.

Changes in current or future laws or regulations or the imposition of new laws or regulations, or new interpretations thereof, by federal or state agencies or foreign governments could impair our ability to compete in international markets.

Changes in current laws or regulations applicable to us or the imposition of new laws and regulations in the United States or other jurisdictions in which we do business, such as Canada, France, Italy and China, could materially and adversely affect our business, financial condition and results of operations. In addition, changes in our products or changes in export and import laws and implementing regulations may create delays in the introduction of new products in international markets, prevent our customers from deploying our products internationally or, in some cases, prevent the export or import of our products to certain countries altogether. While we are not aware of any current or proposed export or import regulations which would materially restrict our ability to sell our products in countries such as Canada, France, Italy or China, any change in export or import regulations or related legislation, shift in approach to the enforcement or scope of existing regulations, or change in the countries, persons or technologies targeted by these regulations, could result in decreased use of our products by, or in our decreased ability to export or sell our products to, existing or potential customers with international operations. In such event, our business and results of operations could be adversely affected.

Risks Related to This Offering and Our Common Stock

An active, liquid and orderly market for our common stock may not develop or be sustained, the trading prices of our common stock may be volatile and you may be unable to sell your shares at or above the offering price.

There has not been a public trading market for shares of our common stock prior to this offering. An active trading market may not develop or be sustained after this offering, which could depress the market price of our common stock and affect your ability to sell your shares. The initial public offering price for the shares of common stock sold in this offering may not be indicative of the price at which our common stock will trade after this offering.

The market price of our common stock could be subject to wide fluctuations in response to, among other things, the risk factors described in this section of this prospectus, and other factors beyond our control, such as fluctuations in the valuation of companies perceived by investors to be comparable to us. Furthermore, the stock markets have experienced price and volume fluctuations that have affected and continue to affect the market prices of equity securities of many companies. These fluctuations often have been unrelated or disproportionate to the operating performance of those companies. These broad market and industry fluctuations, as well as general economic, political and market conditions, such as recessions, interest rate changes or international currency fluctuations, may negatively affect the market price of our common stock. In the past, many companies that have experienced volatility in the market price of their stock have been subject to securities class action litigation. We may become the target of this type of litigation in the future. Securities litigation against us could result in substantial costs and divert our management's attention from other business concerns, which could seriously harm our business.

Our financial results may vary significantly from quarter to quarter due to a number of factors, which may lead to volatility in our stock price.

Our quarterly revenue and results of operations have varied in the past and may continue to vary significantly from quarter to quarter. This variability may lead to volatility in our stock price as research analysts and investors respond to these quarterly fluctuations. These fluctuations are due to numerous factors, including:

- fluctuations in demand for our products;
- the timing, volume and product mix of sales of our products, which may have different average selling prices or profit margins;
- changes in our pricing and sales policies or the pricing and sales policies of our competitors;
- our ability to design, manufacture and deliver products to our customers in a timely and cost-effective manner and that meet customer requirements;
- our ability to manage our relationships with our contract manufacturers, customers and suppliers;
- quality control or yield problems in our manufacturing operations;
- the anticipation, announcement or introductions of new or enhanced products by our competitors and ourselves;
- reductions in the retail price of electricity;
- changes in laws, regulations and policies applicable to our business and products, particularly those relating to government incentives for solar energy applications;
- unanticipated increases in costs or expenses;
- the amount and timing of operating costs and capital expenditures related to the maintenance and expansion of our business operations;
- the impact of government-sponsored programs on our customers;

Table of Contents

- our exposure to the credit risks of our customers, particularly in light of the fact that some of our customers are relatively new entrants to the solar market without long operating or credit histories;
- our ability to estimate future warranty obligations due to product failure rates;
- our ability to forecast our customer demand, manufacturing requirements and manage our inventory;
- fluctuations in our gross profit;
- our ability to predict our revenue and plan our expenses appropriately; and
- fluctuations in foreign currency exchange rates.

The foregoing factors are difficult to forecast, and these, as well as other factors, could materially and adversely affect our quarterly and annual results of operations. Any failure to adjust spending quickly enough to compensate for a revenue shortfall could magnify the adverse impact of this revenue shortfall on our results of operations. Moreover, our results of operations may not meet our announced guidance or the expectations of research analysts or investors, in which case the price of our common stock could decrease significantly. There can be no assurance that we will be able to successfully address these risks.

If research analysts do not publish research about our business or if they issue unfavorable commentary or downgrade our common stock, our stock price and trading volume could decline.

The trading market for our common stock will depend in part on the research and reports that research analysts publish about us and our business. The price of our common stock could decline if one or more research analysts downgrade our stock or if those analysts issue other unfavorable commentary or cease publishing reports about us or our business. If one or more of the research analysts ceases coverage of our company or fails to publish reports on us regularly, demand for our common stock could decrease, which could cause our stock price or trading volume to decline.

Our principal stockholders, executive officers and directors own a significant percentage of our stock and will continue to have significant control of our management and affairs after the offering, and they may take actions that our stockholders may not view as beneficial.

Following the completion of this offering, our executive officers and directors, and entities that are affiliated with them, will beneficially own an aggregate of approximately % of our outstanding common stock, on an as-converted basis. This significant concentration of share ownership may adversely affect the trading price for our common stock because investors often perceive disadvantages in owning stock in companies with controlling stockholders. Also, as a result, these stockholders, acting together, may be able to control our management and affairs and matters requiring stockholder approval, including the election of directors and approval of significant corporate transactions, such as mergers, consolidations or the sale of substantially all of our assets. Consequently, this concentration of ownership may have the effect of delaying or preventing a change in control, including a merger, consolidation or other business combination involving us, or discouraging a potential acquirer from making a tender offer or otherwise attempting to obtain control, even if this change in control would benefit our other stockholders.

Our stock price could decline due to the large number of outstanding shares of our common stock eligible for future sale, which may dilute your voting power and your ownership interest in us.

Sales of substantial amounts of our common stock in the public market following this offering, or the perception that these sales could occur, could cause the market price of our common stock to decline. These sales could also make it more difficult for us to sell equity or equity-related securities in the future at a time and price that we deem appropriate.

[Table of Contents](#)

Upon completion of this offering, as of _____, 2011, we will have an aggregate of _____ shares of common stock outstanding, assuming no exercise of the underwriters' over-allotment option, no exercise of outstanding options and exercise of all outstanding warrants. The _____ shares sold pursuant to this offering will be immediately tradable without restriction. Of the remaining shares:

- no shares will be eligible for sale immediately upon completion of this offering; and
- 241,996,235 shares, as of June 30, 2011, will be eligible for sale upon the expiration of lock-up agreements, subject in some cases to volume and other restrictions of Rule 144 and Rule 701 under the Securities Act of 1933, as amended, or the Securities Act.

The number of shares eligible for sale upon expiration of lock-up agreements assumes the conversion of all outstanding shares of our preferred stock into an aggregate of 228,552,739 shares of common stock.

The lock-up agreements expire 180 days after the date of this prospectus, subject to potential extension in the event we release earning results or material news or a material event relating to us occurs near the end of the lock-up period. Morgan Stanley, as one of the representatives of the underwriters, may, in their sole discretion and at any time without notice, release all or any portion of the securities subject to lock-up agreements.

Holders of approximately 228,552,739 shares, or _____%, of our common stock will have rights, subject to some conditions, to require us to file registration statements covering the sale of their shares or to include their shares in registration statements that we may file for ourselves or other stockholders. After the completion of this offering, we also intend to register approximately 30,080,000 shares of our common stock that have been issued or reserved for future issuance under our stock incentive plans. Once we register the offer and sale of shares for the holders of registration rights and option holders, they can be freely sold in the public market upon issuance, subject to the lock-up agreements or unless they are held by "affiliates," as that term is defined in Rule 144 of the Securities Act.

We may also issue shares of our common stock or securities convertible into our common stock from time to time in connection with a financing, acquisition, investments or otherwise. Any such issuance could result in substantial dilution to our existing stockholders and cause the trading price of our common stock to decline.

Because our initial public offering price is substantially higher than the pro forma as adjusted net tangible book value per share of our outstanding common stock, new investors will incur immediate and substantial dilution.

The initial public offering price is substantially higher than the pro forma as adjusted net tangible book value per share of our common stock based on the expected total value of our total assets, less our intangible assets, less our total liabilities immediately following this offering. Therefore, if you purchase shares of our common stock in this offering, you will experience immediate and substantial dilution of \$ _____ per share in the price you pay for our common stock as compared to the pro forma as adjusted net tangible book value as of March 31, 2011. Furthermore, investors purchasing our common stock in this offering will own only _____% of our shares outstanding even though they will have contributed _____% of the total consideration received by us in connection with our sales of common stock. To the extent outstanding options and warrants to purchase common stock are exercised, there will be further dilution. For a further description of the dilution that you will experience immediately after this offering, see the section titled "Dilution."

Our management has broad discretion in the use of the net proceeds from this offering and may not use the net proceeds in ways that increase the value of your investment.

Our management will have broad discretion in the application of the net proceeds of this offering, and you will be relying on the judgment of our management regarding the application of these proceeds. We cannot assure you that our management will apply the net proceeds from this offering in ways that increase the value of your investment. Except as described in the section of this prospectus titled "Use of Proceeds," we have not allocated the net proceeds from this offering for any specific purpose and we cannot specify with certainty the

[Table of Contents](#)

uses to which we will apply the net proceeds we will receive from this offering. Until we use the net proceeds from this offering, we plan to invest them, and these investments may not yield a favorable rate of return. If we do not invest or apply the net proceeds from this offering in ways that enhance stockholder value, we may fail to achieve expected financial results, which could cause our stock price to decline.

We currently do not intend to pay dividends on our common stock and, consequently, your only opportunity to achieve a return on your investment is if the price of our common stock appreciates.

We currently do not plan to declare dividends on shares of our common stock in the foreseeable future. In addition, the terms of our bank loan agreements restrict our ability to pay dividends. See “Dividend Policy” for more information. Consequently, your only opportunity to achieve a return on your investment in our company will be if the market price of our common stock appreciates and you sell your shares at a profit. There is no guarantee that the price of our common stock that will prevail in the market after this offering will ever exceed the price that you pay.

Our charter documents and Delaware law could prevent a takeover that stockholders consider favorable and could also reduce the market price of our stock.

Our certificate of incorporation and our bylaws that will be in effect upon the closing of this offering contain provisions that could delay or prevent a change in control of our company. These provisions could also make it more difficult for stockholders to elect directors and take other corporate actions, including effecting changes in our management. These provisions include:

- providing for a classified board of directors with staggered, three-year terms, which could delay the ability of stockholders to change the membership of a majority of our board of directors;
- not providing for cumulative voting in the election of directors, which limits the ability of minority stockholders to elect directory candidates;
- authorizing our board of directors to issue, without stockholder approval, preferred stock rights senior to those of common stock, which could be used to significantly dilute the ownership of a hostile acquiror;
- prohibiting stockholder action by written consent, which forces stockholder action to be taken at an annual or special meeting of our stockholders;
- requiring special meetings of stockholders may only be called by our chairman of the board, our chief executive officer, our president or a majority of our board of directors, which could delay the ability of our stockholders to force consideration of a proposal or to take action, including the removal of directors; and
- requiring advance notification of stockholder nominations and proposals, which may discourage or deter a potential acquiror from conducting a solicitation of proxies to elect the acquiror’s own slate of directors or otherwise attempting to obtain control of us.

In addition, the provisions of Section 203 of the Delaware General Corporate Law will govern us upon completion of this offering. These provisions may prohibit large stockholders, in particular those owning 15% or more of our outstanding common stock, from engaging in certain business combinations without approval of substantially all of our stockholders for a certain period of time.

These provisions in our certificate of incorporation, our bylaws and under Delaware law could discourage potential takeover attempts, reduce the price that investors might be willing to pay for shares of our common stock in the future and result in the market price being lower than it would be without these provisions. See “Description of Capital Stock—Preferred Stock” and “Description of Capital Stock—Anti-Takeover Effects of Delaware Law and our Charter Documents.”

SPECIAL NOTE REGARDING FORWARD-LOOKING STATEMENTS AND INDUSTRY DATA

This prospectus contains forward-looking statements that are based on our management's beliefs and assumptions and on information currently available to our management. The forward-looking statements are contained principally in the sections entitled "Prospectus Summary," "Risk Factors," "Management's Discussion and Analysis of Financial Condition and Results of Operations," "Business" and "Compensation Discussion and Analysis." Forward-looking statements include information concerning our possible or assumed future results of operations, business strategies, technology developments, financing and investment plans, competitive position, industry and regulatory environment, potential growth opportunities and the effects of competition. Forward-looking statements include statements that are not historical facts and can be identified by terms such as "anticipates," "believes," "could," "seeks," "estimates," "expects," "intends," "may," "plans," "potential," "predicts," "projects," "should," "will," "would" or similar expressions and the negatives of those terms.

Forward-looking statements involve known and unknown risks, uncertainties and other factors that may cause our actual results, performance or achievements to be materially different from any future results, performance or achievements expressed or implied by the forward-looking statements. Given these uncertainties, you should not place undue reliance on these forward-looking statements. Also, forward-looking statements represent our management's beliefs and assumptions only as of the date of this prospectus. You should read this prospectus and the documents that we have filed as exhibits to the registration statement, of which this prospectus is a part, completely and with the understanding that our actual future results may be materially different from what we expect.

Important factors that could cause actual results to differ materially from our expectations are disclosed under "Risk Factors" and elsewhere in this prospectus, including, without limitation, in conjunction with the forward-looking statements appearing elsewhere in this prospectus. Some of the factors that we believe could affect our results include:

- our history of losses, which may continue in the future;
- our limited operating history, which makes it difficult to predict future results;
- the future demand for solar energy solutions;
- the reduction, elimination or expiration of government subsidies and economic incentives for on-grid solar electricity applications;
- our ability to achieve broad market acceptance of our microinverter systems;
- changes in the retail price of electricity derived from the utility grid or alternative energy sources;
- our ability to develop new and enhanced products in response to customer demands and rapid market and technological changes in the solar industry;
- the success of competing solar solutions that are or become available;
- our ability to effectively manage the growth of our organization and expansion into new markets;
- our ability to maintain or achieve anticipated product quality, product performance and cost metrics;
- our inability to accurately estimate future warranty expense;
- competition and other factors that may cause potential future price reductions for our products;
- our ability to optimally match production with demand;
- our dependence on a limited number of outside contract manufacturers and lack of supply contracts with these manufacturers;
- general economic conditions in our domestic and international markets;

[Table of Contents](#)

- our ability to retain key personnel and attract additional qualified personnel;
- our ability to protect and defend our intellectual property; and
- the other factors set forth under “Risk Factors.”

Except as required by law, we assume no obligation to update these forward-looking statements, or to update the reasons actual results could differ materially from those anticipated in these forward-looking statements, even if new information becomes available in the future.

This prospectus also contains estimates and other information concerning our industry, including market size and growth rates, that are based on industry publications, surveys and forecasts, including those generated by the California Solar Initiative (CSI), the Solar Energy Industries Association (SEIA), and IMS Research. The Datamonitor Group (Datamonitor), Westinghouse Solar (Westinghouse), and iSuppli Corporation (iSuppli). This information involves a number of assumptions and limitations. Although we believe the information in these industry publications, surveys and forecasts is reliable, we have not independently verified the accuracy or completeness of the information. The industry in which we operate is subject to a high degree of uncertainty and risk due to variety of factors, including those described in “Risk Factors.” These and other factors could cause actual results to differ materially from those expressed in these publications, surveys and forecasts.

USE OF PROCEEDS

We estimate that the net proceeds from our sale of shares of common stock in this offering at an assumed initial public offering price of \$ per share, the midpoint of the price range set forth on the front cover of this prospectus, after deducting estimated underwriting discounts and commissions and estimated offering expenses, will be approximately \$ million, or \$ million if the underwriters' option to purchase additional shares is exercised in full. A \$1.00 increase (decrease) in the assumed initial public offering price would increase (decrease) the net proceeds to us from this offering by \$ million, assuming the number of shares offered by us, as set forth on the cover page of this prospectus, remains the same and after deducting the estimated underwriting discounts and commissions.

We anticipate that we will use the net proceeds of this offering primarily for working capital for the growth of our business and general corporate purposes, including expenses associated with investment and expansion in domestic and international operations, investments in research and development to accelerate development of next-generation and complementary products, and capital expenditures, including those related to our new headquarters lease, our product verification and testing equipment and additional capital equipment. Overall, our management will have broad discretion in the application of our net proceeds from this offering, and investors will be relying on the judgment of our management regarding the application of these proceeds. We may also use an additional portion of the net proceeds to us for repayment of outstanding indebtedness, but we currently have no commitments or specific plans to repay any indebtedness in advance of its maturity date. We may also use a portion of the net proceeds to us to acquire complementary businesses, products, services or technologies, but we currently have no agreements or commitments relating to any material acquisitions.

Pending their use, we plan to invest the net proceeds to us from this offering in short term, interest bearing obligations, investment grade instruments, certificates of deposit or direct or guaranteed obligations of the U.S. government.

DIVIDEND POLICY

We have never declared or paid dividends on our common stock and do not expect to pay dividends on our common stock for the foreseeable future. Instead, we anticipate that all of our earnings in the foreseeable future will be used for the operation and growth of our business. Any future determination to pay dividends on our common stock would be subject to the discretion of our board of directors and would depend upon various factors, including our results of operations, financial condition, liquidity requirements, restrictions that may be imposed by applicable law and our agreements and other factors deemed relevant by our board of directors. Our loan and security agreements with Horizon Technology Finance Corporation, Hercules Technology Growth Capital, Inc., Bridge Bank, National Association and Comerica Bank, as well as with the lenders under our junior convertible loan facility, all prohibit the payment of dividends.

CAPITALIZATION

The following table sets forth our consolidated capitalization as of March 31, 2011 on:

- an actual basis;
- on a pro forma basis to reflect (1) the conversion of all outstanding shares of our preferred stock into 228,552,739 shares of common stock, and (2) the reclassification of our convertible preferred stock warrant liability to additional paid-in capital immediately prior to the completion of this offering; and
- on a pro forma as adjusted basis to reflect (1) the pro forma adjustment described above, (2) the sale of _____ shares of common stock in this offering at an assumed initial public offering price of \$ _____ per share, the midpoint of the price range reflected on the front cover of this prospectus, after deducting estimated underwriting discounts and commissions and estimated offering expenses payable by us and (3) the filing of our amended and restated certificate of incorporation in connection with this offering.

You should read this table together with “Management’s Discussion and Analysis of Financial Condition and Results of Operations” and our audited and unaudited consolidated financial statements and the related notes, each appearing elsewhere in this prospectus.

	As of March 31, 2011		
	Actual	Pro Forma	Pro Forma As Adjusted ⁽¹⁾
	(in thousands, except par value)		
Convertible preferred stock warrant liability	\$ 954	\$ —	\$ —
Stockholders’ equity:			
Convertible preferred stock, \$0.00001 par value, 213,913 shares authorized, 201,765 shares issued and outstanding actual; no shares authorized, issued and outstanding pro forma and pro forma as adjusted	93,596	—	—
Common stock, \$0.00001 par value; 308,000 shares authorized, 7,745 shares issued and outstanding actual; 308,000 shares authorized, 236,297 issued and outstanding pro forma; and _____ shares authorized, _____ shares issued and outstanding pro forma as adjusted	—	2	
Additional paid-in capital	1,788	96,336	
Accumulated deficit	(65,807)	(65,807)	
Total stockholders’ equity	29,577	30,531	
Total capitalization	<u>\$ 30,531</u>	<u>\$ 30,531</u>	<u>\$</u>

(1) A \$1.00 increase (decrease) in the assumed initial public offering price would result in an approximately \$ _____ million increase (decrease) in pro forma as adjusted cash and cash equivalents, and an approximately \$ _____ million increase (decrease) in each of pro forma as adjusted additional paid-in capital, total stockholders’ equity and total capitalization. If the underwriters exercise their over-allotment option in full, there would be a \$ _____ increase in each of pro forma as adjusted cash and cash equivalents, additional paid-in capital, total stockholders’ equity and total capitalization.

The number of shares of common stock shown as issued and outstanding in the above table excludes:

- 3,808,221 shares of common stock issued to our employees and consultants from April 1, 2011 through June 30, 2011 pursuant to exercises of options granted under our 2006 Equity Incentive Plan;
- 1,890,609 shares of common stock issued on June 14, 2011 in connection with our junior secured convertible loan facility;

[Table of Contents](#)

- 2,747,165 shares of common stock issuable upon exercise of outstanding warrants, as of June 30, 2011, with a weighted-average exercise price of \$0.66 per share;
- 53,885,595 shares of common stock issuable upon the exercise of outstanding stock options under our 2006 Equity Incentive Plan, as of June 30, 2011, with a weighted-average exercise price of \$0.13 per share;
- 24,000,000 shares of common stock reserved for future issuance under our 2011 Equity Incentive Plan, which will become effective prior to the completion of this offering and contains provisions that will automatically increase its share reserve each year, as more fully described in “Executive Compensation—Employee Benefit Plans”;
- 6,080,000 shares of common stock reserved for future issuance under our 2011 Employee Stock Purchase Plan, which will become effective prior to the completion of this offering and contains provisions that will automatically increase its share reserve each year, as more fully described in “Executive Compensation—Employee Benefit Plans”; and
- 12,755,102 shares of common stock issuable upon conversion of the outstanding principal amount of our junior secured convertible loan facility at a conversion price of \$0.98 per share.

DILUTION

If you invest in our common stock, your interest will be diluted to the extent of the difference between the amount per share paid by purchasers of shares of our common stock in this initial public offering and the pro forma as adjusted net tangible book value per share of our common stock immediately after completion of this offering.

At March 31, 2011, we had net tangible book value of \$29.3 million. Net tangible book value represents the amount of our net assets of \$29.6 million less our intangible assets of 0.3 million. At March 31, 2011, our pro forma net tangible book value was \$30.3 million (pro forma net assets of \$30.6 million less pro forma intangible assets of \$0.3 million) or \$0.13 per share of common stock. Pro forma net tangible book value per share represents the amount of our net tangible book value increased by the amount of our convertible preferred stock warrant liability and divided by the pro forma shares of common stock outstanding at March 31, 2011, assuming the automatic conversion of all outstanding shares of our preferred stock into an aggregate of 228,552,739 shares of common stock and the conversion of warrants to purchase 1,570,588 shares of preferred stock into warrants to purchase 1,721,988 shares of common stock in connection with this offering.

After giving effect to our sale of _____ shares of common stock in this offering at an assumed initial public offering price of \$ _____, the midpoint of the price range set forth on the front cover of this prospectus, and after deducting estimated underwriting discounts and commissions and estimated offering expenses, our pro forma as adjusted net tangible book value at March 31, 2011 would have been \$ _____ million, or \$ _____ per share of common stock. This represents an immediate increase in pro forma net tangible book value of \$ _____ per share to existing stockholders and an immediate dilution of \$ _____ per share to new investors.

The following table illustrates this dilution:

Assumed initial public offering price per share	\$ _____
Pro forma net tangible book value per share as of March 31, 2011 before giving effect to this offering	\$0.13
Increase in pro forma net tangible book value per share attributable to new investors purchasing shares in this offering	_____
Pro forma as adjusted net tangible book value per share after this offering	_____
Dilution per share to new investors in this offering	\$ _____

The following table summarizes, on a pro forma as adjusted basis as of March 31, 2011, the total number of shares of common stock purchased from us, the total consideration paid to us and the average price per share paid to us by existing stockholders and by new investors purchasing shares in this offering at the assumed initial public offering price of \$ _____, the midpoint of the price range set forth on the front cover of this prospectus, before deducting estimated underwriting discounts and commissions and estimated offering expenses:

	Shares Purchased		Total Consideration		Average Price
	Number	Percent	Amount	Percent	Per Share
Existing stockholders		%	\$ _____	%	\$ _____
New investors					
Total	_____	100%	\$ _____	100%	\$ _____

A \$1.00 increase or decrease in the assumed initial public offering price would increase or decrease, as applicable, total consideration paid to us by new investors and total consideration paid to us by all stockholders by approximately \$ _____ million, assuming the number of shares offered by us remains the same as set forth on the cover page of this prospectus and without deducting the estimated underwriting discounts and commissions and estimated offering expenses that we must pay.

[Table of Contents](#)

The foregoing dilution calculations exclude:

- 3,808,221 shares of common stock issued to our employees and consultants from April 1, 2011 through June 30, 2011 pursuant to exercises of options granted under our 2006 Equity Incentive Plan;
- 1,890,609 shares of common stock issued on June 14, 2011 in connection with our junior secured convertible loan facility;
- 2,747,165 shares of common stock issuable upon exercise of outstanding warrants, as of June 30, 2011, with a weighted-average exercise price of \$0.66 per share;
- 53,885,595 shares of common stock issuable upon the exercise of outstanding stock options under our 2006 Equity Incentive Plan, as of June 30, 2011, with a weighted-average exercise price of \$0.13 per share;
- 24,000,000 shares of common stock reserved for future issuance under our 2011 Equity Incentive Plan, which will become effective prior to the completion of this offering and contains provisions that will automatically increase its share reserve each year, as more fully described in “Executive Compensation—Employee Benefit Plans”;
- 6,080,000 shares of common stock reserved for future issuance under our 2011 Employee Stock Purchase Plan, which will become effective prior to the completion of this offering and contains provisions that will automatically increase its share reserve each year, as more fully described in “Executive Compensation—Employee Benefit Plans”; and
- 12,755,102 shares of common stock issuable upon conversion of the outstanding principal amount of our junior secured convertible loan facility at a conversion price of \$0.98 per share.

To the extent that any outstanding options or warrants are exercised, there will be further dilution to new investors.

SELECTED CONSOLIDATED FINANCIAL DATA

The selected consolidated balance sheet data as of December 31, 2009 and 2010 and the selected consolidated statement of operations data for 2008, 2009 and 2010 are derived from our audited consolidated financial statements included elsewhere in this prospectus. The selected consolidated balance sheet data as of December 31, 2007 and 2008 are derived from our audited financial statements not included in this prospectus. The selected consolidated statement of operations data for the period from March 20, 2006 (inception) to December 31, 2006 and for 2007 are derived from our unaudited consolidated financial statements not included in this prospectus. We derived the selected consolidated statement of operations data for the three months ended March 31, 2010 and 2011 and the selected consolidated balance sheet as of March 31, 2011 from our unaudited consolidated financial statements appearing elsewhere in this prospectus. Our historical results are not indicative of the results to be expected in any future period, and the results for the three months ended March 31, 2011 are not necessarily indicative of the results to be expected for the full year or any other period. You should read these selected financial data in conjunction with “Management’s Discussion and Analysis of Financial Condition and Results of Operations” and our financial statements and the related notes included elsewhere in this prospectus.

	March 20, 2006 (Inception) to December 31, 2006	Year Ended December 31,				Three Months Ended March 31,	
		2007	2008	2009	2010	2010	2011
(in thousands, except per share data)							
Consolidated Statement of Operations Data:							
Net revenues	\$ —	\$ —	\$ 1,668	\$ 20,194	\$ 61,661	\$ 11,587	\$ 18,069
Cost of revenues ⁽¹⁾	—	—	7,475	23,223	55,159	10,631	15,421
Gross profit (loss)	—	—	(5,807)	(3,029)	6,502	956	2,648
Operating expenses:							
Research and development ⁽¹⁾	148	2,068	5,354	8,411	14,296	2,735	5,345
Sales and marketing ⁽¹⁾	39	458	1,809	2,651	6,558	855	3,010
General and administrative ⁽¹⁾	45	742	1,727	2,603	6,365	1,099	3,250
Total operating expenses	232	3,268	8,890	13,665	27,219	4,689	11,605
Loss from operations	(232)	(3,268)	(14,697)	(16,694)	(20,717)	(3,733)	(8,957)
Other income (expense), net:							
Interest income	6	179	206	125	39	10	4
Interest expense	—	—	(9)	(356)	(914)	(75)	(280)
Other income (expense)	—	—	(1)	—	(185)	(1)	(56)
Total other income (expense), net	6	179	196	(231)	(1,060)	(66)	(332)
Net loss	\$ (226)	\$ (3,089)	\$ (14,501)	\$ (16,925)	\$ (21,777)	\$ (3,799)	\$ (9,289)
Net loss attributable to common stockholders	\$ (226)	\$ (3,089)	\$ (14,501)	\$ (16,925)	\$ (21,777)	\$ (3,799)	\$ (9,289)
Net loss per share attributable to common stockholders, basic and diluted ⁽²⁾	\$ (0.28)	\$ (1.02)	\$ (2.72)	\$ (2.85)	\$ (3.19)	\$ (0.59)	\$ (1.21)
Shares used in computing net loss per share attributable to common stockholders, basic and diluted ⁽²⁾	806	3,038	5,333	5,932	6,829	6,434	7,695
Pro forma net loss per share attributable to common stockholders, basic and diluted ⁽²⁾					\$ (0.10)		\$ (0.04)
Pro forma shares used in computing pro forma net loss per share attributable to common stockholders basic and diluted ⁽²⁾					216,536		236,248

Table of Contents

	As of December 31,					As of March 31,
	2006	2007	2008	2009	2010	2011
	(in thousands)					
Consolidated Balance Sheet Data:						
Cash and cash equivalents	\$335	\$2,548	\$ 4,136	\$ 8,642	\$39,993	\$ 30,524
Working capital	327	2,322	2,521	11,004	39,753	30,399
Total assets	378	3,325	8,710	20,947	59,504	54,834
Current and long-term debt	—	—	571	411	6,903	8,581
Convertible preferred stock	584	6,209	21,871	47,859	93,596	93,596
Common stock and additional paid-in capital	12	81	298	509	1,403	1,788
Total stockholders' equity	370	2,975	4,353	13,627	38,481	29,577

(1) Includes stock-based compensation expense as follows (in thousands):

	Year Ended December 31,				Three Months Ended March 31,	
	2007	2008	2009	2010	2010	2011
	(in thousands)					
Cost of revenues	\$ —	\$ 4	\$ 17	\$ 9	\$ 1	\$ 2
Research and development		27	62	286	25	140
Sales and marketing		7	36	256	14	137
General and administrative	70	170	65	278	24	96
Total stock-based compensation expense	<u>\$ 70</u>	<u>\$208</u>	<u>\$180</u>	<u>\$829</u>	<u>\$ 64</u>	<u>\$ 375</u>

(2) See Note 13 of the notes to our consolidated financial statements for a description of how we compute basic and diluted net loss attributable to common stockholders, basic and diluted net loss per share attributable to common stockholders and pro forma basic and diluted net loss per share attributable to common stockholders.

MANAGEMENT'S DISCUSSION AND ANALYSIS OF FINANCIAL CONDITION AND RESULTS OF OPERATIONS

The following discussion and analysis of our financial condition and results of operations should be read in conjunction with the consolidated financial statements and related notes thereto included in this prospectus. In addition to historical information, this discussion and analysis contains forward-looking statements that involve risks, uncertainties and assumptions. Our actual results could differ materially from those discussed in the forward-looking statements. We discuss factors that we believe could cause or contribute to these differences below and elsewhere in this prospectus, particularly the "Special Note Regarding Forward-Looking Statements and Industry Data" and "Risk Factors" sections.

Overview

We have pioneered a fundamentally new inverter technology for the solar industry that increases energy production, simplifies design and installation, improves system uptime and reliability, reduces fire safety risk and provides a platform for intelligent energy management. We created the microinverter category and have grown rapidly since our first commercial shipment in mid-2008, with over 650,000 microinverter units shipped as of March 31, 2011, representing over an estimated 20,000 system installations. We were the first company to commercially ship microinverter systems in volume. Our products have been installed in all 50 U.S. states and eight Canadian provinces, and we are rapidly taking market share from traditional central inverter manufacturers.

We were founded in March 2006 and began generating revenue in June 2008. From inception to March 2011, we raised over \$100 million in cash proceeds primarily through the issuance of preferred stock. The history of our product development and sales and marketing efforts is as follows:

- From inception to the second quarter of fiscal 2008, our efforts focused on developing a complete microinverter solution for the solar PV industry;
- In the second quarter of 2008, we began selling our first generation microinverter along with our Envoy communications gateway device and our Enlighten web-based monitoring service;
- In the first half of 2009, we focused on the development of our second generation microinverter and migrated our contract manufacturing to Flextronics, which provided us with access to commercial scale manufacturing and logistics services;
- In the third quarter of 2009, we began selling our second generation microinverter in volume;
- In 2010, we invested in our sales and marketing organization to increase market penetration, continued design innovations for our second generation microinverter, sold more than 400,000 units and commenced development of our third generation microinverter;
- In the first quarter of 2011, we opened offices in France and Italy; and
- In the second quarter of 2011, we began selling our third generation microinverter.

We sell our microinverter systems primarily to distributors who resell them to solar installers. Through our distributors, we have built a network of over 2,200 installers in North America through March 31, 2011, and are adding approximately 100 new installers per month. We also sell directly to large installers and through OEMs and strategic partners.

A substantial majority of our revenue has been generated by sales within the United States. Sales to customers in Canada commenced in 2009 and accounted for approximately 13% of our total revenue in 2010. We anticipate that the majority of our 2011 revenue will continue to come from the United States, with the balance from Canada and, to a lesser extent, Europe.

[Table of Contents](#)

We have achieved substantial growth since we commenced commercial production in 2008. Our total revenue was \$1.7 million, \$20.2 million, and \$61.7 million for 2008, 2009, and 2010, respectively, and was \$11.6 million and \$18.1 million for the first three months of 2010 and 2011, respectively. Net losses have totaled \$14.5 million, \$16.9 million and \$21.8 million for 2008, 2009 and 2010, respectively, and were \$3.8 million and \$9.3 million for the first three months of 2010 and 2011, respectively. We expect to incur net losses in 2011 and may continue to incur net losses in future years as we continue to invest substantial resources to support the growth of our business. However, over time, we believe the significant investments we are making to scale our business will allow us to achieve an increasingly efficient operating cost structure. We believe that this, combined with the differentiated value proposition of our microinverter solution including product cost reductions through further semiconductor integration, will allow us to improve our gross profit and reduce our operating expenses as a percentage of revenue.

Results of Operations

The following describes the line items in our Consolidated Statements of Operations.

Net Revenues

We generate revenue from sales of our microinverter systems, which include microinverter units, an Envoy communications gateway device, and our Enlighten web-based monitoring service. We sell to distributors, large installers, OEMs and strategic partners.

Our revenue is affected by changes in the volume and average selling prices of our microinverter systems, driven by supply and demand, sales incentives, and competitive product offerings. Our revenue growth is dependent on our ability to market our products in a manner that increases awareness for microinverter technology, the continual development and introduction of new products to meet the changing technology and performance requirements of our customers, and the diversification and expansion of our revenue base.

Cost of Revenues and Gross Profit

Cost of revenues is comprised primarily of product costs consisting of purchases from our contract manufacturers and other suppliers, warranty, personnel and logistics costs, depreciation and amortization of test equipment and hosting services costs. Our product costs are impacted by technological innovations, such as advances in semiconductor integration and new product introductions, economies of scale resulting in lower component costs, and improvements in production processes and automation. Certain of these costs, primarily personnel and depreciation and amortization of test equipment, are not directly affected by sales volume.

We outsource our manufacturing to third-party manufacturers and negotiate product pricing on a quarterly basis. In addition, a contract manufacturer also serves as our logistics provider by warehousing and delivering our products in the United States and Canada. We believe our contract manufacturing partners have sufficient production capacity to meet the growing demand for our products for the foreseeable future. However, shortages in the supply of certain key raw materials could adversely affect our ability to meet customer demand for our products.

Gross profit may vary from quarter to quarter and is primarily affected by our average selling prices, product costs, geographical mix and seasonality.

Operating Expenses

Operating expenses consist of research and development, sales and marketing and general and administrative expenses. Personnel-related costs are the most significant component of each of these expense categories and include salaries, benefits, payroll taxes, recruiting costs, commissions and stock-based compensation. Our full-time employee headcount has grown from 59 at December 31, 2008, to 80 at

[Table of Contents](#)

December 31, 2009, to 154 at December 31, 2010 and to 190 at March 31, 2011. We expect to continue to hire significant numbers of new employees to support our growth. The timing of these additional hires could materially affect our operating expenses, both in absolute dollars and as a percentage of revenue, in any particular period. We expect to continue to invest substantial resources to support the growth of our company globally and anticipate that each of the following categories of operating expenses will increase in absolute dollar amounts for the foreseeable future.

Research and development expense includes personnel-related expenses such as salaries, stock-based compensation and employee benefits. Our research and development employees are engaged in the design and development of power electronics, semiconductors, powerline communications and networking and software functionality. Our research and development expense also includes third-party design and development costs, testing and evaluation costs, depreciation expense and other indirect costs. We devote substantial resources in ongoing research and development programs that focus on enhancements to and cost efficiencies in our existing products and timely development of new products that utilize technological innovation to drive down products costs. We intend to continue to invest substantial resources in our research and development efforts because we believe they are essential to maintaining our competitive position. Investments in research and development personnel costs are expected to increase in total dollars for the foreseeable future.

Sales and marketing expense consists primarily of personnel-related expenses such as salaries, commissions, stock-based compensation, employee benefits, and travel. It also includes trade shows, marketing, customer support and other indirect costs. We expect our sales and marketing expense to increase in absolute dollars for the foreseeable future as we continue to increase the number of our sales and channel support personnel to enable us to increase our market penetration geographically and into new markets by expanding our customer base of distributors, large installers, OEMs and strategic partners. Historically, all of our sales have been in the United States and Canada. In the first quarter of 2011, we opened sales offices in Italy and France and expect to begin selling into those geographies by the end of 2011. We expect to continue to expand our geographic footprint in the future.

General and administrative expense consists primarily of salaries, stock-based compensation and employee benefits for personnel related to our executive, finance, human resources, information technology and legal organizations, facilities cost, including additional annual rent expense of approximately \$0.4 million related to our new corporate headquarters, expected to begin in the fourth quarter of 2011, and fees for professional services. Professional services consist of outside legal, accounting and information technology consulting costs. We expect that after this offering we will incur additional accounting and legal costs related to compliance with securities and other regulations, as well as additional insurance, investor relations and other costs associated with being a public company.

Other Income (Expense), Net

Other income (expense), net includes interest income on invested cash balances and interest expense on amounts outstanding under our credit facilities. Other income (expense), net also includes mark-to-market adjustments to record our preferred stock warrants at fair value, which were issued in conjunction with credit facilities, as well as losses or gains on conversion of non-U.S. dollar transactions into U.S. dollars.

Provision (Benefit) for Income Taxes

We did not record any current or deferred United States federal or state income tax provision or benefit for any of the periods presented because we have experienced operating losses since inception. Due to the history of losses we have generated since inception, we have recorded a full valuation allowance on our deferred tax assets.

[Table of Contents](#)

Summary Consolidated Statements of Operations

The following table sets forth a summary of our consolidated statements of operations for the periods presented (in thousands):

	Year Ended December 31,			Three Months Ended March 31,	
	2008	2009	2010	2010	2011
Net revenues	\$ 1,668	\$ 20,194	\$ 61,661	\$11,587	\$18,069
Cost of revenues	7,475	23,223	55,159	10,631	15,421
Gross profit (loss)	(5,807)	(3,029)	6,502	956	2,648
Operating expenses:					
Research and development	5,354	8,411	14,296	2,735	5,345
Sales and marketing	1,809	2,651	6,558	855	3,010
General and administrative	1,727	2,603	6,365	1,099	3,250
Total operating expenses	8,890	13,665	27,219	4,689	11,605
Loss from operations	(14,697)	(16,694)	(20,717)	(3,733)	(8,957)
Other income (expense), net	196	(231)	(1,060)	(66)	(332)
Net loss	<u>\$(14,501)</u>	<u>\$(16,925)</u>	<u>\$(21,777)</u>	<u>\$(3,799)</u>	<u>\$(9,289)</u>

Comparison of the Three Months Ended March 31, 2010 and March 31, 2011

Net Revenues

	Three Months Ended March 31,		Change
	2010	2011	
	(in thousands)		
Net revenues	\$11,587	\$18,069	\$6,482

Net revenues for the three months ended March 31, 2011 increased by 56% compared to the three months ended March 31, 2010. The number of microinverter units sold increased by 66% from approximately 74,000 units in the three months ended March 31, 2010 to approximately 123,000 units in the three months ended March 31, 2011. The increase in units sold was driven by deeper penetration of our existing customer base, the addition of new customers, further expansion into Canada, and broader acceptance of our products resulting, among other factors, from investments made in sales and marketing. The increase in net revenues from the sale of additional units was offset by approximately \$2.2 million resulting from a slight decline in the average selling price of our microinverter units. The decline in average selling prices reflects, and is consistent with, recent market trends in the solar industry. We expect these trends to continue in the foreseeable future.

Cost of Revenues and Gross Profit

	Three Months Ended March 31,		Change
	2010	2011	
	(in thousands)		
Cost of revenues	\$10,631	\$15,421	\$4,790
Gross profit	956	2,648	1,692

Cost of revenues for the three months ended March 31, 2011 increased primarily due to an increase in the number of microinverter units sold to customers, consistent with the overall increase in net revenues as described

[Table of Contents](#)

above. Gross profit as a percentage of revenue increased from 8.3% in the three months ended March 31, 2010 to 14.7% in the three months ended March 31, 2011. Of this change, approximately 4.6 percentage points of the increase in gross profit as a percentage of revenue was driven by a reduction in material cost per unit primarily resulting from more favorable pricing on raw materials, and to a lesser extent, from design enhancements for our existing products and efficiency gains in the manufacturing process. The remaining increase in gross profit as a percentage of revenue was attributable to improved leverage of certain costs, primarily personnel, which are not directly affected by higher sales volumes.

Research and Development

	Three Months Ended March 31,		Change
	2010	2011	
	(in thousands)		
Research and development	\$ 2,735	\$ 5,345	\$ 2,610

The increase in research and development expenses was primarily attributable to a \$2.0 million increase in personnel-related costs as a result of increases in research and development headcount in the three months ended March 31, 2011 compared to the three months ended March 31, 2010. The increase in headcount reflects our continuing investment in development of existing products as well as efforts to bring new products to market, including our third generation microinverters. In addition, expenditures on research and development equipment increased by \$0.5 million from the prior year period.

Sales and Marketing

	Three Months Ended March 31,		Change
	2010	2011	
	(in thousands)		
Sales and marketing	\$ 855	\$ 3,010	\$ 2,155

The increase in sales and marketing expenses resulted primarily from increased staffing levels to support higher sales volumes and international expansion. Personnel-related costs increased by \$1.7 million as a result of increases in sales and marketing headcount in the three months ended March 31, 2011 compared to the three months ended March 31, 2010. In addition, costs associated with outside services contributed approximately \$0.3 million of the increase. Other sales and marketing expenses increased due to costs associated with the growth of our business.

General and Administrative

	Three Months Ended March 31,		Change
	2010	2011	
	(in thousands)		
General and administrative	\$ 1,099	\$ 3,250	\$ 2,151

The increase in general and administrative expenses was primarily attributable to a \$1.3 million increase in personnel-related costs as a result of increases in general and administrative headcount and a \$0.5 million increase in accounting, legal and other professional services incurred in relation to our initial public offering readiness effort. In addition, depreciation and amortization and facilities costs contributed \$0.3 million to the increase in the three months ended March 31, 2011 compared to the three months ended March 31, 2010.

[Table of Contents](#)**Other Income (Expense), Net**

	Three Months Ended March 31,		Change
	2010	2011	
Other income (expense), net	\$ (66)	\$ (332)	\$ (266)

Other income (expense), net increased primarily due to interest expense in connection with a \$7.0 million term loan which we entered into in March 2010.

Comparison of 2008, 2009 and 2010**Net Revenues**

	Year Ended December 31,			Change	
	2008	2009	2010	2008 to 2009	2009 to 2010
Net revenues	\$1,668	\$20,194	\$61,661	\$ 18,526	\$ 41,467

Net revenues for 2010 increased by 205% compared to 2009. The increase in net revenues was due to the number of microinverter units sold increasing by 229% from approximately 126,000 units in 2009 to approximately 414,000 units in 2010. The increase in units sold was driven by deeper penetration of our existing customer base, the addition of new customers, further expansion into Canada, and broader acceptance of our products resulting, among other factors, from investments made in sales and marketing. The increase in net revenues from the sale of additional units was offset by approximately \$1.7 million resulting from a slight decline in the average selling price of our microinverter units. The decline in average selling prices reflects, and is consistent with, recent market trends in the solar industry. We expect these trends to continue in the foreseeable future. As of December 31, 2010, our products had sold to more than 2,000 installers, compared to more than 600 installers as of December 31, 2009.

We commenced commercial production in June 2008 and generated minimal revenues during the balance of the year. In 2009, we achieved substantial growth as a result of increased market awareness for microinverters in general, as well as the introduction of our second generation product.

Cost of Revenues and Gross Profit (Loss)

	Year Ended December 31,			Change	
	2008	2009	2010	2008 to 2009	2009 to 2010
Cost of revenues	\$ 7,475	\$23,223	\$55,159	\$ 15,748	\$ 31,936
Gross profit (loss)	(5,807)	(3,029)	6,502	2,778	9,531

Cost of revenues for 2010 increased from 2009 primarily due to an increase in the number of microinverter units sold to customers, consistent with the overall increase in net revenues as described above. Gross profit (loss) as a percentage of revenue increased from (15%) in 2009 to 10.5% in 2010. Prior to 2010, we had negative gross profit as our sales were insufficient to cover our product costs as well as personnel costs, which are not directly affected by sales volume. In 2010, we achieved economies of scale and positive gross profit as we ramped up production of our higher margin second generation product.

Cost of revenues in 2009 increased as a result of an increase in the number of units sold in 2009, compared to 2008, consistent with the overall increase in net revenues.

[Table of Contents](#)**Research and Development**

	Year Ended December 31,			Change	
	2008	2009	2010	2008 to 2009	2009 to 2010
Research and development	\$5,354	\$8,411	\$14,296	\$ 3,057	\$ 5,885

Research and development expenses increased from 2009 to 2010 primarily due to increases in research and development headcount. Salaries and related personnel expenses accounted for \$4.2 million of the \$5.9 million increase in research and development expenses. In addition, outsourced engineering fees and other outside services fees increased by approximately \$1.6 million related to the development of new features for our next generation of products. We plan to continue to invest in research and development as we develop new products and make further enhancements to existing products.

Research and development expense increased from 2008 to 2009 primarily due to increases in research and development headcount. Salaries and related personnel expenses accounted for \$2.3 million of the \$3.1 million increase in research and development expenses. In addition, depreciation and related expenses increased as a result of additional research and development technology assets purchased in 2009.

Sales and Marketing

	Year Ended December 31,			Change	
	2008	2009	2010	2008 to 2009	2009 to 2010
Sales and marketing	\$1,809	\$2,651	\$6,558	\$ 842	\$ 3,907

Sales and marketing expenses increased from 2009 to 2010 primarily due to increases in sales and marketing headcount. Salaries and related personnel expenses accounted for \$3.0 million of the \$3.9 million increase in sales and marketing expenses as a result of expansion of our sales organization in order to increase product awareness and expand our sales presence. We expect that sales and marketing expenses will continue to increase in absolute dollars as we expand sales operations domestically and internationally.

Sales and marketing expenses increased from 2008 to 2009 primarily due to increases in sales and marketing headcount. Salaries and related personnel expenses accounted for substantially all of the \$842,000 increase in sales and marketing expenses.

General and Administrative

	Year Ended December 31,			Change	
	2008	2009	2010	2008 to 2009	2009 to 2010
General and administrative	\$1,727	\$2,603	\$6,365	\$ 876	\$ 3,762

General and administrative expenses increased from 2009 to 2010 due to increases in general and administrative headcount. Salaries and related personnel expenses accounted for \$2.3 million of the \$3.8 million increase in general and administrative expenses. Also, professional services fees increased \$690,000. The additional personnel and professional services fees are primarily the result of our on-going efforts to build the legal, finance, human resources, recruiting and information technology functions required of a public company. In addition, depreciation and amortization and facilities costs also contributed \$0.6 million to the increase in 2010 over 2009. We expect to incur additional expenses as a result of operating as a public company, including costs to comply with the Sarbanes-Oxley Act and the rules and regulations applicable to companies listed on the NASDAQ Stock Market.

Table of Contents

General and administrative expenses increased from 2008 to 2009 due, in part, to a \$260,000 increase in personnel and related costs as a result of increases in general and administrative headcount. Also, professional services fees and rent expense increased \$165,000 and \$144,000, respectively. In addition, total other miscellaneous corporate expenses including utilities, insurance, depreciation and amortization increased \$300,000 from 2008 to 2009.

Other Income (Expense), Net

	Year Ended December 31,			Change	
	2008	2009	2010	2008 to 2009	2009 to 2010
Other income (expense), net	\$ 196	\$(231)	\$(1,060)	\$ (427)	\$ (829)

(in thousands)

Other income (expense), net increased from 2009 to 2010 primarily due to interest expense related to increased borrowings in 2010.

Other income (expense), net in 2009 was comprised primarily of interest expense including amounts from a beneficial conversion feature charge related to the conversion of \$1.5 million of promissory notes into Series D convertible preferred stock at a discount, less interest income.

Other income (expense), net in 2008 was comprised primarily of interest income.

Provision for Income Taxes

We did not provide any current or deferred United States federal or state income tax provision or benefit for any of the years presented because we have experienced operating losses since inception.

Quarterly Results of Operations

The following table presents our unaudited quarterly results of operations for the nine quarters in the period ended March 31, 2011. This unaudited quarterly information has been prepared on the same basis as our audited financial statements and includes all adjustments, consisting only of normal recurring adjustments, necessary for the fair presentation of the information for the quarters presented. You should read this information in conjunction with our audited consolidated financial statements and the related notes thereto. The results of operations for any quarter are not necessarily indicative of results of operations for any future period.

	Three Months Ended								
	Mar 31, 2009	Jun 30, 2009	Sep 30, 2009	Dec 31, 2009	Mar 31, 2010	Jun 30, 2010	Sep 30, 2010	Dec 31, 2010	Mar 31, 2011
Net revenues	\$ 1,159	\$ 1,625	\$ 5,407	\$12,003	\$11,587	\$10,769	\$18,690	\$20,615	\$18,069
Costs of revenues	2,672	3,725	5,681	11,145	10,631	9,464	16,650	18,414	15,421
Gross profit (loss)	(1,513)	(2,100)	(274)	858	956	1,305	2,040	2,201	2,648
Operating expenses:									
Research and development	1,752	2,061	2,249	2,349	2,735	3,160	3,968	4,433	5,345
Sales and marketing	513	489	661	988	855	1,280	1,955	2,468	3,010
General and administrative	534	482	533	1,054	1,099	1,387	1,900	1,979	3,250
Total operating expenses	2,799	3,032	3,443	4,391	4,689	5,827	7,823	8,880	11,605
Loss from operations	(4,312)	(5,132)	(3,717)	(3,533)	(3,733)	(4,522)	(5,783)	(6,679)	(8,957)
Other income (expense), net	(9)	(250)	28	—	(66)	(329)	(458)	(207)	(332)
Net loss	<u>\$(4,321)</u>	<u>\$(5,382)</u>	<u>\$(3,689)</u>	<u>\$(3,533)</u>	<u>\$(3,799)</u>	<u>\$(4,851)</u>	<u>\$(6,241)</u>	<u>\$(6,886)</u>	<u>\$(9,289)</u>

[Table of Contents](#)

The following table presents the unaudited quarterly results of operations as a percentage of revenue:

	Three Months Ended								
	Mar 31, 2009	Jun 30, 2009	Sep 30, 2009	Dec 31, 2009	Mar 31, 2010	Jun 30, 2010	Sep 30, 2010	Dec 31, 2010	Mar 31, 2011
Net revenues	100%	100%	100%	100%	100%	100%	100%	100%	100%
Costs of revenues	231	229	105	93	92	88	89	89	85
Gross profit (loss)	(131)	(129)	(5)	7	8	12	11	11	15
Operating expenses:									
Research and development	151	127	42	20	24	29	21	22	30
Sales and marketing	44	30	12	8	7	12	10	12	17
General and administrative	46	30	10	9	9	13	10	10	18
Total operating expenses	242	187	64	37	40	54	42	43	64
Loss from operations	(372)	(316)	(69)	(29)	(32)	(42)	(31)	(32)	(50)
Other income (expense), net	(1)	(15)	(1)	—	(1)	(3)	(2)	(1)	(2)
Net loss	(373)%	(331)%	(68)%	(29)%	(33)%	(45)%	(33)%	(33)%	(51)%

Quarterly Revenue Trends

Our quarterly results reflect seasonality and cyclicity in the sale of our products. In general, we expect our product revenue in the third and fourth quarters to be positively affected by seasonal customer demand trends, including solar economic incentives, weather patterns and construction cycles. Although these seasonal factors are common in the solar sector, historical patterns should not be considered a reliable indicator of our future sales activity or performance. In the future, the effects of seasonality and cyclicity may also be impacted by our expansion into international markets.

Total revenue and unit sales have generally increased over the nine quarters presented due to the adoption of our existing products, the success of new product introductions and our ability to acquire new customers in our target markets as well as increased sales to existing customers. Quarterly revenue generally has increased sequentially during the last nine quarters, with revenue increasing from the preceding period in six of the nine quarters presented. Sequential revenue growth in the fourth quarter of 2009 resulted from the successful introduction of our second generation microinverter launched at the end of the previous quarter. In the second quarter of 2010, revenues were negatively affected by an unexpected increase in channel inventory caused by temporary weakness in installer demand and overall market dynamics in the solar industry. Installer demand in early 2010 was impacted by an unseasonably long winter, resulting in sluggish consumer demand for solar systems. Since this time, we have improved our visibility into channel inventory levels through programs designed to incent our distributors to provide timely reporting related to inventory levels. In the first quarter of 2011, the decline in net revenue from the preceding quarter was primarily the result of seasonality.

Quarterly Gross Profit Trends

Our gross profit, as a percentage of revenue, is impacted by average selling prices, product costs, geographical mix and seasonality. Gross profit generally has improved over the nine quarters presented due to improvements in product costs resulting from economies of scale and improvements in production processes and automation, which have lowered the overall unit production cost over time. Gross profit has also benefited from our generating sales volumes sufficient to cover personnel and other costs not directly affected by sales volume. Gross profit has increased sequentially in six of the nine quarters presented. Gross profit has fluctuated on a quarterly basis primarily due to shifts in the average selling prices for our products and product costs. Gross profits in the third and fourth quarters of 2009 improved sequentially primarily due to the successful introduction of our lower-cost, second generation microinverter which had completely replaced our first-generation product by the end of 2009. Gross profits in the third and fourth quarters of 2010 were negatively impacted by costs

[Table of Contents](#)

incurred to expedite the procurement and delivery of certain raw materials and finished goods. Gross profit in the first quarter of 2011 increased sequentially due to lower product cost per unit and reduced use of expedited air-freight for finished goods to meet demand due to improvements in delivery scheduling. We anticipate that gross profit will fluctuate from quarter to quarter as a result of changes in average selling prices, product costs, geographical mix and seasonality.

Quarterly Operating Expense Trends

To establish operational scale and to accommodate our growth, our operating expenses increased sequentially in all quarters. Increases in operating expenses have been largely attributable to adding headcount in all areas and growing investment in research and development, increase in sales and marketing efforts and increase in general and administrative expenses for accounting and professional fees. We expect to continue to increase our operating expenses in absolute dollar amounts to support the growth of our company, although over time we expect these expenses to decrease as a percentage of revenue.

Liquidity and Capital Resources

We have historically financed our operating activities and capital expenditures primarily through proceeds from the issuances of convertible preferred stock, debt borrowings and cash receipts from customers. As of March 31, 2011, we had \$30.5 million in cash and cash equivalents and \$30.4 million in working capital.

The following table summarizes our cash flows for the periods indicated:

	Year Ended December 31,			Three Months Ended	
	2008	2009	2010	March 31,	2011
			(in thousands)		
Net cash used in operating activities	\$ (12,233)	\$ (18,887)	\$ (17,852)	\$ (5,009)	\$ (9,007)
Net cash used in investing activities	(2,619)	(2,122)	(3,262)	(464)	(2,318)
Net cash provided by financing activities	16,440	25,515	52,465	27,775	1,856

Net Cash Used in Operating Activities

We have experienced net negative cash flows from operations as we have expanded our business and built our infrastructure. Our cash flows from operating activities will continue to be affected principally by the extent to which we manage our working capital and spend on increasing personnel in order to grow our business. Our largest source of operating cash flows is cash collections from our customers.

Cash used in operating activities increased \$4.0 million from the three months ended March 31, 2010, as compared to the same period in 2011, primarily due to the \$5.5 million increase in net loss, driven by investments made to expand our business and build our infrastructure. This increase was partially offset by a decrease in cash used in inventory in the 2011 period compared to the 2010 period resulting from higher inventory turns.

Cash used in operating activities decreased from 2009 to 2010 by \$1.0 million. The decrease was primarily driven by an improvement of working capital management of approximately \$4.5 million as our sales volume increased substantially, partially offset by a \$4.9 million increase in net loss due to the overall growth in our business activities and an increase in employee headcount across all functions.

Cash used in operating activities increased from 2008 to 2009 due to our increased net loss resulting from higher operating expenses to support our growth in 2009.

Net Cash Used in Investing Activities

Net cash used in investing activities primarily related to capital expenditures to support our growth.

[Table of Contents](#)

Net cash used in investing activities increased \$1.9 million from the three months ended March 31, 2010, as compared to the same period in 2011. The increase was primarily due to higher net capital expenditures on manufacturing test equipment as well as development of software for internal use.

Cash used in investing activities increased from \$2.1 million in 2009 to \$3.3 million in 2010 due primarily to capital expenditures. Capital expenditures in 2010 primarily related to leasehold improvements for corporate offices, manufacturing test equipment, research and development lab equipment, and development of software for internal use.

Cash used in investing activities decreased from \$2.6 million in 2008 to \$2.1 million in 2009 due primarily to capital expenditures. Preceding the launch of our first product in June 2008, we incurred capital expenditures primarily related to research and development lab equipment, leasehold improvements for corporate offices and manufacturing test equipment.

Net Cash Provided by Financing Activities

We have financed our operations primarily through private sales of convertible preferred stock totaling \$92.2 million through March 31, 2011, and the use of our venture debt and credit facilities.

Financing activities in the three months ended March 31, 2011 included proceeds of \$2.0 million from a venture debt term loan. Financing activities in the three months ended March 31, 2010 included proceeds of \$21.0 million from our Series E convertible preferred stock financing and \$7.0 million from a venture debt term loan.

Cash flows provided by financing activities were higher in 2010 compared to 2009 as we sold 67,471,300 shares of our Series E convertible preferred stock in April, May and June 2010 for net proceeds of \$45.7 million. In March 2010, we entered into a venture debt agreement and borrowed \$7.0 million under the agreement.

Cash flows provided by financing activities were higher in 2009 compared to 2008 as we sold 103,522,345 shares of our Series D convertible preferred stock in April and May 2009 for net proceeds of \$24.2 million. In April 2008, we sold 11,675,878 shares of our Series C convertible preferred stock for net proceeds of \$14.9 million and in January 2008 we sold 1,132,075 shares of Series B convertible preferred stock for net proceeds of \$750,000. In December 2008, we borrowed \$571,000 under a line of credit arrangement.

Debt Obligations

Our debt obligations are summarized below. Our Convertible Facility, Term Loan and Revolving Line of Credit Facility are secured by substantially all of our assets except intellectual property and contain certain required financial covenants. As of March 31, 2011, we were in compliance with these required financial covenants.

Convertible Facility

On June 14, 2011, we entered into a junior secured convertible loan facility, or Convertible Facility, with certain existing preferred stockholders that provides for up to \$50.0 million in borrowings. We borrowed \$12.5 million upon signing and may borrow up to an additional \$37.5 million prior to the earlier of (i) a subsequent equity financing of more than \$10.0 million or (ii) June 14, 2013, subject to the attainment of certain financial and operating conditions. The Convertible Facility bears interest at a rate of 9%, with interest payable in-kind at maturity, which is the earlier to occur of the closing of (i) our initial public offering, (ii) a change in control or (iii) June 14, 2014. Because of the pay-in-kind feature, we expect to record interest expense in excess of the stated rate. In connection with this facility, we issued shares of common stock and warrants to purchase common stock. See Note 15 to Consolidated Financial Statements. The Convertible Facility is secured by all of our assets except intellectual property, prohibits dividend payments and restricts prepayment of the convertible portion of

[Table of Contents](#)

any outstanding loans under the facility. The agreement also requires us to meet certain minimum gross profit metrics and maximum warranty claim rates in order to be eligible for further advances under the facility.

Equipment Financing Facility

On June 13, 2011, we entered into \$5 million equipment financing facility with Hercules Technology Growth Capital, Inc. The equipment financing facility has a variable interest rate set at the higher of 5.75% above the prime lending rate and 9.0% annually and expires July 1, 2014. This facility is secured by the financed equipment and restricts our ability to pay dividends and take on certain types of additional liens. In connection with this facility, we issued warrants to purchase Series E preferred stock. See Note 15 to Consolidated Financial Statements.

Term Loan

We have a loan and security agreement with Horizon Technology Finance Corporation, or Original Term Loan, pursuant to which we borrowed \$7.0 million at an interest rate of 12.6% for a 42-month term, maturing on October 1, 2013. On March 25, 2011, we entered into an amendment to the Original Term Loan to provide for an additional \$2.0 million term loan, which was fully drawn upon at execution of the amendment and an additional \$3.0 million term loan available to be drawn upon through July 31, 2011, together, the Additional Term Loans, both of which mature on the first calendar day of the month that follows the 42-month anniversary of the date of advance. As of March 31, 2011, the \$2.0 million outstanding principal balance will mature on October 1, 2014. The Additional Term Loans have an interest rate of 10.75% and all borrowings have a 42-month term. Monthly payments for the first 12 months are interest only; subsequent monthly payments include interest and principal, based on a 30-month remaining amortization period. The other terms and conditions of the Original Term Loan remain substantially unchanged. The loan provides for penalties for early repayment and is secured by all our assets except intellectual property. The loan also prohibits any dividend payments and restricts our ability to take on certain additional liens, or make prepayments on certain other indebtedness.

Revolving Line of Credit Facility

We have a revolving line of credit under a loan and security agreement with Bridge Bank, National Association and Comerica Bank that provides for up to \$25.0 million in borrowings, based on a percentage of eligible receivables and a percentage of inventory (up to \$10.0 million). The line of credit has a variable interest rate set at 1.25% above the bank's prime lending rate and expires March 24, 2013. The facility includes a \$5.0 million letter of credit subfacility. As of March 31, 2011, we had not drawn any amounts under the revolving line of credit facility. Any advance under the facility is collateralized by the underlying receivables or inventory and is secured by all of our assets except intellectual property. The agreement requires us to maintain minimum asset coverage and tangible net worth requirements and restricts our ability to pay dividends, take on certain additional liens, or make prepayments on certain other indebtedness.

Line of Credit Agreement

We have a line of credit agreement with ATEL Ventures, Inc. that provides for borrowings of up to \$1.0 million. The line of credit has an interest rate of approximately 14% and expires December 15, 2011. As of March 31, 2011, this line of credit had an outstanding principal balance of \$168,000. Specific assets were pledged as collateral for amounts drawn under the line of credit. Any amounts drawn under the line of credit are subject to penalties for early repayment. The line of credit does not include financial covenants or other material covenant requirements.

Operating and Capital Expenditure Requirements

Since inception, our operations have been financed primarily through sales of our convertible preferred stock. Our principal current sources of liquidity are cash on our balance sheet, cash generated by sales of products, borrowings under our credit facilities and our Convertible Facility.

[Table of Contents](#)

Based on our current financial condition, we believe that liquidity from available sources without giving effect to the proceeds from this offering will be adequate to fund our current and long-term debt obligations as well as our planned capital expenditures and business plans over the next 12 months. In the future, we expect our operating and capital expenditures to increase as we increase headcount, expand our business activities and grow our customer base which will result in higher needs for working capital. Our ability to generate cash from operations is also subject to substantial risks described under the caption “Risk Factors.” If any of these risks occur, we may be unable to generate or sustain positive cash flow from operating activities or raise additional capital. We would then be required to use existing cash and cash equivalents to support our working capital and other cash requirements. If additional sources of liquidity are required to support our working capital requirements or operational expansion, we may seek to raise funds through debt financing or from other sources, but we can provide no assurance that these transactions could be consummated on acceptable terms to us or at all. Failure to raise sufficient capital when needed could have a material adverse effect on our business, results of operations and financial position.

Contractual Obligations

The following table summarizes our outstanding contractual obligations as of December 31, 2010:

	Total	Payments Due by Period			
		2011	2012	2013	2014
			(in thousands)		
Debt	\$ 7,233	\$ 2,567	\$ 2,800	\$ 1,866	\$ —
Interest payments on debt	1,159	645	426	88	—
Capital leases	58	52	6	—	—
Operating leases	1,646	595	619	430	2
Purchase obligations ⁽¹⁾	20,350	18,315	2,035	—	—
Total	<u>\$30,446</u>	<u>\$22,174</u>	<u>\$ 5,886</u>	<u>\$ 2,384</u>	<u>\$ 2</u>

(1) Represents amounts associated with our contract manufacturers that are non-cancelable. Such purchase commitments are based on our forecasted manufacturing requirements and typically provide for fulfillment within agreed upon lead-times and/or commercially standard lead-times for the particular part or product. The timing and amount of payments represent our best estimate and may change due to changing business needs and other factors.

On March 25, 2011, we borrowed \$2.0 million under the term loan described under “Debt Obligations” above.

On June 3, 2011, we entered into an agreement to lease approximately 96,000 square feet of office space for our new corporate headquarters. Our minimum obligation under this agreement is approximately \$13.5 million, payable over the ten-year term of the lease. An estimated \$4.5 million of capital expenditures in 2011 will be necessary to complete the tenant improvements, furnishings and technology for the new office space.

On June 14, 2011, we borrowed \$12.5 million pursuant to the terms of the Convertible Facility, as discussed above.

Off-Balance Sheet Arrangements

Since our inception, we have not engaged in any off-balance sheet arrangements, such as the use of structured finance, special purpose entities or variable interest entities.

Critical Accounting Policies and Significant Management Estimates

Our consolidated financial statements are prepared in accordance with accounting principles generally accepted in the U.S., or GAAP. In connection with the preparation of our consolidated financial statements, we are required to make assumptions and estimates about future events, and apply judgments that affect the reported

[Table of Contents](#)

amounts of assets, liabilities, revenue, expenses and the related disclosures. We base our assumptions, estimates and judgments on historical experience, current trends and other factors that management believes to be relevant at the time our consolidated financial statements are prepared. On a regular basis, we review the accounting policies, assumptions, estimates and judgments to ensure that our consolidated financial statements are presented fairly and in accordance with GAAP. However, because future events and their effects cannot be determined with certainty, actual results could differ from our assumptions and estimates, and such differences could be material.

Our significant accounting policies are discussed in Note 2 to Consolidated Financial Statements. We believe that the following accounting estimates are the most critical to aid in fully understanding and evaluating our reported financial results, and they require our most difficult, subjective or complex judgments, resulting from the need to make estimates about the effect of matters that are inherently uncertain.

Revenue Recognition

Our primary source of revenues is the sale of microinverter systems. Our products are fully functional at the time of shipment and do not require production, modification or customization. We currently sell our products primarily to distributors, who typically resell our products to end users. We also sell directly to large installers as well as through OEMs, who integrate our products into complete solutions, and strategic partners.

Revenues from the sales of microinverters and communication gateway devices are recognized when: (i) persuasive evidence of an arrangement exists; (ii) delivery of the products has occurred in accordance with the terms of the sales agreement and title of and risk of loss has passed to the customer; (iii) the sale price is fixed or determinable; and (iv) collection is reasonably assured. Title to the product typically passes upon shipment of the product, as our products are typically shipped FOB shipping point. We do not offer rights to return our products other than for normal warranty conditions. As such, we recognize revenues upon shipment, assuming all other revenue recognition criteria have been met. We occasionally offer promotional program incentives including rebates and discounts on a limited time basis to installers and distributors based on the number of installations and unit sales, respectively. Such customer incentives are not material and are estimated using our historical experience. Incentives are recorded as reductions to net revenues at the time of sale or over the period of time in which they are earned, depending on the nature of the program.

Prior to June 2011, we sold Envoy communications gateway devices and our Enlighten web-based monitoring service separately. Revenues from our Enlighten web-based monitoring services are recognized ratably over the term of the service period, which is generally one or five years. Historically, Enlighten service revenue has represented less than 1% of total revenues in any given reporting period. Beginning in June 2011, each sale of an Envoy communications gateway device will include our Enlighten web-based monitoring service. After allocating the overall consideration from such sale to each deliverable using a best estimate of the selling price, (i) revenues from the sale of Envoy devices will be recognized upon shipment, assuming all other revenue recognition criteria have been met and (ii) revenues from the web-based monitoring service will be recognized ratably over the estimated economic life of the related Envoy devices. We expect revenues from our web-based monitoring service will continue to be insignificant.

Inventory Valuation

Inventories are valued at the lower of cost or market, on a first-in, first-out basis. Certain factors could affect the realizable value of our inventories including market and economic conditions, technological changes, new product introductions and changes in strategic direction. We consider historic usage, expected demand, anticipated sales price, the effect of new product introductions, product obsolescence, customer concentrations, product merchantability and other factors when evaluating the value of inventories. Inventory write-downs are equal to the difference between the cost of inventories and their estimated fair market value. Inventory write-downs are recorded as cost of revenues in the accompanying statements of operations and were \$0.2 million, \$50,000 and \$0.1 million in 2008, 2009 and 2010, respectively, and were \$86,000 and zero in the three months ended March 31, 2010 and 2011, respectively.

[Table of Contents](#)

We do not believe there is a reasonable likelihood that there will be a material change in the future estimates or assumptions that we use to record inventory at the lower of cost or market. However, if estimates regarding customer demand are inaccurate or changes in technology affect demand for certain products in an unforeseen manner, we may be exposed to losses that could be material.

Product Warranty

We provide a warranty against defects in materials and workmanship under normal use and service conditions for our microinverters. Our first and second generation microinverters include a 15-year limited warranty. Our third generation microinverters provide for a 25-year limited warranty period. Since we have only been producing microinverters for a comparatively short period, the calculation of warranty provisions is inherently uncertain. We accrue for estimated warranty costs at the time of sale based on anticipated warranty claims and actual historical warranty claims experience. Warranty provisions are computed on a per unit sold basis and are based on our best estimate of such costs and are included in cost of revenues. The warranty obligation is determined based on product failure rates, cost of replacement and service and delivery costs incurred to correct a product failure. Our warranty obligation requires management to make assumptions regarding estimated failure rates and replacement costs. Product failure rates are estimated by using field monitoring of the actual failure rates of the microinverters we have shipped to date. With over 750,000 of our microinverter units shipped across North America to date, we have established reliability as represented by a MTBF rate of approximately 0.3% per year. MTBF is the predicted elapsed time between inherent failures of a system during operation. In addition, due to our limited operating history, we also utilize third party data collected on similar equipment deployed in outdoor environments similar to those in which our microinverters are installed, as well as accelerated lab testing, which simulates the entire service life of the product in a short period of time using standard tests used by solar module vendors to determine the period over which the modules and microinverters may wear out. Replacement costs are updated periodically to reflect changes in our actual and estimated production costs for our microinverters. If actual warranty costs differ significantly from these estimates, adjustments may be required in the future, which could adversely affect our gross profit and operating results. The warranty provision was \$0.5 million, \$1.0 million and \$1.9 million in 2008, 2009 and 2010, respectively, and was \$0.5 million and \$0.7 million for the three months ended March 31, 2010 and 2011, respectively.

In addition, we support our microinverters with our Entrust program. We reimburse the system owner for any lost energy for up to one month if a microinverter unit should fail (which we refer to as our “100% uptime guarantee”). We estimate that our microinverter systems achieve system uptimes of over 99.8%. Historically, disbursements under the Entrust program have been insignificant, and therefore no accruals have been recorded for any such future obligations.

Stock-Based Compensation

The accounting for share-based payments requires the measurement and recognition of compensation expense for all share-based payment awards made to employees and directors based on the grant date fair values of the awards. The fair value of each stock option granted is estimated using the Black-Scholes option pricing model. Stock-based compensation, net of estimated forfeitures, is recognized on a straight-line basis over the requisite service period, which is typically four years. Stock-based compensation expenses are classified based on the employee’s functional department.

The Black-Scholes option pricing model requires management to make assumptions and to apply judgment in determining the fair value of our awards. The most significant assumptions and judgments include estimating the fair value of underlying stock, expected volatility and expected term. In addition, the recognition of stock-based compensation expense is impacted by estimated forfeiture rates.

[Table of Contents](#)

Our board of directors has historically set the exercise price of options to purchase our common stock at a price per share not less than the fair value of the common stock at the time of grant. To determine the fair value of our common stock, our board of directors, with input from management, considered many factors, including but not limited to:

- independent third-party valuations using the methodologies described below;
- our historical, current and expected future operating performance;
- recent prices at which our preferred stock was sold, including the liquidation rights and other preferences of our preferred stock;
- our financial condition at the date of grant;
- achievement of product development milestones;
- lack of marketability of our common stock associated with private company status and the potential future marketability of our common stock as a result of a liquidity event, such as an initial public offering;
- business risks inherent in our business and in technology, solar and clean technology companies generally; and
- macroeconomic trends and capital market conditions.

We estimated the expected volatility based on the historical volatilities of several comparable public companies within the solar and clean technology industries because our common stock has no trading history. The weighted-average expected life of options was calculated using the “simplified” method developed by the SEC staff. The risk-free interest rate is based on the U.S. Treasury yields in effect at the time of grant for periods corresponding to the expected term of the options. The expected dividend rate is zero based on the fact that we have not historically paid dividends and have no intention to pay cash dividends in the foreseeable future. The forfeiture rate is estimated based on the historical average period of time that options were outstanding and adjusted for expected changes in future exercise patterns.

Total stock-based compensation expense recognized for 2008, 2009 and 2010 was \$208,000, \$180,000 and \$829,000, respectively. For the three months ended March 31, 2010 and 2011, expense from stock-based compensation was \$64,000 and \$375,000, respectively. The fair value of each option granted during the periods presented was estimated on the date of grant using the Black-Scholes option pricing model with the following weighted-average assumptions:

	Year Ended December 31,			Three Months Ended	
	2008	2009	2010	2010	2011
Expected term (in years)	5.6	5.9	6.0	6.0	6.0
Expected volatility	73.3%	76.4%	73.3%	75.6%	72.0%
Annual risk-free rate of return	3.0%	2.8%	2.2%	2.8%	2.4%
Dividend yield	0.0%	0.0%	0.0%	0.0%	0.0%

As of December 31, 2010 and March 31, 2011, there was approximately \$3.8 million and \$4.1 million, respectively, of total unrecognized compensation cost related to unvested stock options, net of expected forfeitures, which is expected to be recognized over a weighted-average period of 3.3 years and 3.2 years, respectively.

No income tax benefit has been recognized relating to stock-based compensation expense and no tax benefits have been realized from exercised stock options.

[Table of Contents](#)

The following table summarizes all option grants from January 1, 2010 through March 31, 2011:

<u>Grant Date</u>	<u>Number of Options Granted</u>	<u>Per Share Exercise Price</u>	<u>Common Stock Fair Value Per Share at Grant Date</u>
January 2011	2,631,358	\$ 0.28	\$ 0.45
November 2010	2,955,983	0.23	0.39
July 2010	12,963,210	0.18	0.29
June 2010	4,372,915	0.18	0.25
January 2010	2,846,500	0.07	0.07

Subsequent to March 31, 2011, we granted additional options to purchase approximately 3.0 million shares of common stock with exercise prices ranging from \$0.45 per share to \$0.58 per share.

In the absence of a public trading market for our common stock, we obtained independent third-party valuations of our common stock to assist management in determining the estimated fair value at the grant date. The valuation of our common stock was performed in accordance with the guidelines outlined in the American Institute of Certified Public Accountants Practice Aid, Valuation of Privately-Held-Company Equity Securities Issued as Compensation. In order to value the common stock underlying all option grants, we determined our business equity value by taking a weighted combination of the value indications using two valuation approaches: an income approach and a market approach.

Valuation models employed in determining our enterprise value require the input of highly subjective assumptions. In determining enterprise value under the income approach, a discount rate is applied to the estimated future net cash flows of a company to derive a single present value representing the value of the enterprise. The discounted cash flow model used to recalculate our enterprise value included, among others, the following assumptions: projections of revenues and expenses and related cash flows based on assumed long-term growth rates and demand trends; expected future investments to grow our business; and, an appropriate risk-adjusted discount rate. The market approach estimates the fair value of a company by applying market multiples of the corresponding financial metrics of publicly traded firms in similar lines of business to our historical and/or projected financial metrics. We selected comparable companies based on factors such as business similarity, financial risk, company size and geographic markets. In applying this method, valuation multiples were: (i) derived from historical operating data of the selected comparable entities; (ii) evaluated and/or adjusted based on our strengths and weaknesses relative to the comparable entities; and (iii) applied to our operating data to arrive at a value indication.

Enterprise value, adjusted for cash and debt, was allocated to the shares of convertible preferred stock, warrants, options and shares of common stock using an option pricing method or a probability-weighted estimated return method, or PWERM, depending on our stage of development. The option pricing method treats convertible preferred stock, warrants, options and shares of common stock as call options on the total equity value of a company, and uses the Black-Scholes option pricing model to price the call options. This model defines the securities' fair values as functions of the current fair value of a company and requires the use of assumptions such as the anticipated holding period and the estimated volatility of the equity securities.

Under the PWERM, the value of common stock is estimated based upon an analysis of future values for the enterprise assuming various scenarios and potential future expected outcomes (e.g., an initial public offering, or IPO, a merger or sale, continuing as a private company, or dissolution with no value to common stockholders). Enterprise value is allocated to convertible preferred stock, warrants, options and shares of common stock based on the rights and characteristics of each equity instrument. The resulting share value is based upon the probability-weighted present value of expected future investment returns.

In 2010 and prior periods, we utilized the independent valuation services of an investment bank located in Silicon Valley focused on middle market technology companies, who prepared our valuations based upon the option-pricing method. Beginning in 2011, as we began to more strongly consider an IPO or other liquidity

[Table of Contents](#)

event, we determined that we should engage a new independent valuation firm which has a dedicated national team of valuation professionals that have valued thousands of businesses across all industries ranging in size from Fortune 500 companies to middle market and small businesses. In addition, the valuations performed since January 2011 have been prepared based upon the PWERM.

The following discusses the significant factors considered by our board of directors in determining the exercise price of our common stock at each of the grant dates specified below and management's consideration of fair value for stock compensation purposes.

January 2011. The most significant factor considered by our board of directors in determining the exercise price of our common stock of \$0.28 per share at the grant date was the most recent independent valuation report dated as of November 30, 2010, which estimated the value of our common stock at \$0.28 per share and included the following key assumptions:

- The business enterprise value based on a weighted income approach and market approach of \$184.0 million, an increase from the prior external valuation of \$167.5 million as of August 31, 2010;
- Discount rate of 35% based on the calculated weighted average cost of capital; and
- Lack of marketability discount of 24%.

However, we subsequently determined that a stock compensation charge should be calculated for the difference between the \$0.28 per share exercise price at the grant date and the estimated fair value of \$0.45 per common share at the grant date, based on the following:

- The issuance of Series E Convertible Preferred Stock at \$0.68 per share in March, April and May 2010 resulting in cash proceeds of \$45.7 million, and consideration of the voting, conversion, dividend, liquidation, and other rights and preferences of the preferred shares relative to those of the outstanding common shares;
- Substantial increase in revenues from \$18.7 million in the three months ended September 30, 2010, to \$20.6 million in the three months ended December 31, 2010;
- Substantial increase in sales of microinverters from 126,000 in 2009 to 414,000 in 2010;
- Meaningful increase in gross profit percentage from (15)% in 2009 to 10.5% in 2010;
- Successful hiring of essential research and development, technical, sales and marketing and administrative personnel, increasing total headcount from 80 at December 31, 2009 to 154 at December 31, 2010;
- Continued improvement in the U.S. economy and financial and stock markets;
- Considerable progress made throughout 2010 in the development of our third generation microinverter, which was expected to be available for sale in mid-2011; and
- Consideration of the results of an independent valuation report dated as of January 31, 2011, which estimated the value of our common stock at \$0.45 per share, and included the following key assumptions:
 - Discount rate of 24% based on the calculated weighted average cost of capital and lack of marketability discount of 15% based on a reduction in the assumed time to a liquidity event to occur to approximately one year; and
 - Application of the PWERM, assuming 50% probability of an IPO, 20% probability of merger or sale, 20% probability of continuing as a private company and a 10% probability of dissolution/no value to common stockholders.

As a result, additional compensation expense of \$388,000 related to the January 2011 grants will be recognized over the four year vesting period of the options.

[Table of Contents](#)

November 2010. The most significant factor considered by our board of directors in determining the exercise price of our common stock of \$0.23 per share at the grant date was the most recent independent valuation report dated as of August 31, 2010, which estimated the value of our common stock at \$0.23 per share and included the following key assumptions:

- The business enterprise value based on a weighted income approach and market approach of \$167.5 million, an increase from the prior external valuation of \$133.5 million as of February 28, 2010;
- Discount rate of 33% based on the calculated weighted average cost of capital; and
- Lack of marketability discount of 28% based on an assumed time to a liquidity event to occur of 1.75 years.

However, we subsequently determined that a stock compensation charge should be calculated for the difference between the \$0.23 per share exercise price at the grant date and the estimated fair value of \$0.39 per common share at the grant date, based on the following:

- The issuance of Series E Convertible Preferred Stock at \$0.68 per share in March, April and May 2010 resulting in cash proceeds of \$45.7 million, and consideration of the voting, conversion, dividend, liquidation, and other rights and preferences of the preferred shares relative to those of the outstanding common shares;
- Substantial increase in revenues from \$10.8 million in the three months ended June 30, 2010, to \$18.7 million and \$20.6 million in the three months ended September 30 and December 31, 2010, respectively;
- Substantial increase in sales of microinverters from 126,000 in 2009 to 414,000 in 2010;
- Meaningful increase in gross profit percentage from (15)% in 2009 to 10.5% in 2010;
- Successful hiring of essential research and development, technical, sales and marketing and administrative personnel, increasing total headcount from 80 at December 31, 2009 to 154 at December 31, 2010;
- Continued improvement in U.S. economy and financial and stock markets;
- Considerable progress made throughout 2010 in the development of our third generation microinverter, which is expected to be available for sale in mid-2011; and
- Consideration of an independent valuation report dated as of January 31, 2011, which estimated the value of our common stock at \$0.45 per share as of January 2011 (as discussed above); a retrospective straight-line extrapolation based on the fair value determined by the January 31, 2011 independent valuation report resulted in a revised estimated fair value of \$0.39 per common share as of the November 11, 2010 grant date.

As a result, additional compensation expense of \$408,000 related to the November 2010 grants will be recognized over the four year vesting period of the options.

July 2010. The most significant factor considered by our board of directors in determining the exercise price of our common stock of \$0.18 per share at the grant date was the most recent independent valuation report dated as of February 28, 2010, which estimated the value of our common stock at \$0.18 per share and included the following key assumptions:

- The business enterprise value based on a weighted income approach and market approach of \$133.5 million, an increase from the prior external valuation of \$49.9 million as of October 31, 2009;
- Discount rate of 33% based on the calculated weighted average cost of capital; and
- Lack of marketability discount of 45% based on an assumed time to a liquidity event to occur of approximately two years.

[Table of Contents](#)

However, we subsequently determined that a stock compensation charge should be calculated for the difference between the \$0.18 per share exercise price at the grant date and the estimated fair value of \$0.29 per common share at the grant date, based on the following:

- The issuance of Series E Convertible Preferred Stock at \$0.68 per share in March, April and May 2010 resulting in cash proceeds of \$45.7 million, and consideration of the voting, conversion, dividend, liquidation, and other rights and preferences of the preferred shares relative to those of the outstanding common shares;
- Substantial increase in gross profit percentage from 8.3% in the three months ended March 31, 2010 to 12.1% in the three months ended June 30, 2010;
- Increased likelihood of meeting operating performance benchmarks and forecasted results for the second half of 2010; and
- Consideration of an independent valuation report dated as of January 31, 2011, which estimated the value of our common stock at \$0.45 per share as of January 2011 (as discussed above); a retrospective straight-line extrapolation based on the fair value determined by the January 31, 2011 independent valuation report resulted in a revised estimated fair value of \$0.29 per common share as of the July 15, 2010 grant date.

As a result, additional compensation expense of \$1,236,000 related to the July 2010 grants will be recognized over the four-year vesting period of the options.

June 2010. The most significant factor considered by our board of directors in determining the exercise price of our common stock of \$0.18 per share at the grant date was the most recent independent valuation report dated as of February 28, 2010, described above.

However, we subsequently determined that a stock compensation charge should be calculated for the difference between the \$0.18 per share exercise price at the grant date and the estimated fair value of \$0.25 per common share at the grant date, based on the following:

- The issuance of Series E Convertible Preferred Stock at \$0.68 per share in March, April and May 2010, resulting in cash proceeds of \$45.7 million, and consideration of the voting, conversion, dividend, liquidation, and other rights and preferences of the preferred shares relative to those of the outstanding common shares;
- Substantial increase in the level of quarterly revenues from \$5.4 million in the three months ended September 30, 2009 to \$12.0 million and \$11.6 million in the three months ended December 31, 2009 and March 31, 2010, respectively, and a concurrent improvement in gross profit percentage over such periods;
- Revised increased forecasts for operating performance for 2010 and subsequent years; and
- Consideration of an independent valuation report dated as of January 31, 2011, which estimated the value of our common stock at \$0.45 per share as of January 2011 (as discussed above); a retrospective straight-line extrapolation based on the fair value determined by the January 31, 2011 independent valuation report resulted in a revised estimated fair value of \$0.25 per common share as of the June 3, 2010 grant date.

As a result, additional compensation expense of \$264,000 related to the June 2010 grants will be recognized over the four year vesting period of the options.

January 2010. The most significant factors considered by our board of directors in determining the exercise price of our common stock of \$0.07 per share at the grant date were as follows:

- The most recent independent valuation report dated as of October 31, 2009, which estimated the value of our common stock at \$0.07 per share and included the following key assumptions:
 - The business enterprise value based on a weighted income approach and market approach of \$49.9 million;
 - Discount rate of 43% based on the calculated weighted average cost of capital;

[Table of Contents](#)

- Lack of marketability discount of 38% based upon an assumed time to a liquidity event to occur of approximately 2.5 years;
- Our financial condition and related need for additional working capital; and
- The sale of Series D Convertible Preferred Stock at \$0.235 per share in April and June 2009; resulting in cash proceeds of approximately \$24.2 million, and consideration of the voting, conversion, dividend, liquidation, and other rights and preferences of the preferred shares relative to those of the outstanding common shares.

Quantitative and Qualitative Disclosures about Market Risk

Concentrations of Credit Risk and Major Customers

We are potentially subject to financial instrument concentration of credit risk through our cash equivalents and trade accounts receivable. Credit risk with respect to accounts receivable is relatively concentrated, as three customers respectively represented 14%, 13% and 10% of the total accounts receivable balance as of December 31, 2010. We currently do not foresee a credit risk associated with these receivables. At December 31, 2009, three customers respectively accounted for approximately 21%, 12% and 10% of our total accounts receivable. In 2010, two customers, in the aggregate, accounted for approximately 25% of our net sales. In 2009, three customers, in the aggregate, accounted for approximately 39% of our net sales.

Interest Rate Sensitivity

We place our cash and cash equivalents with major financial institutions that management assesses to be of high credit quality, to limit the exposure of each investment. We had cash and cash equivalents of \$8.6 million, \$40.0 million and \$30.5 million at December 31, 2009, December 31, 2010 and March 31, 2011, respectively, which was held for working capital purposes. We do not enter into investments for trading or speculative purposes. Due to the short-term nature of these investments, we do not believe that we have any material exposure to changes in the fair value as a result of changes in interest rates. Declines in interest rates, however, will reduce future investment income. Interest income was \$39,000 in 2010 and \$4,000 in the three months ended March 31, 2011. Our revolving line of credit agreement was the only instrument we held with variable interest rates which could, if drawn upon, subject us to risks associated with changes in interest rates. As of December 31, 2010 and March 31, 2011, there were no amounts outstanding under this line of credit. If the interest rate on our line of credit rose 10%, our results from operations and cash flows would not be materially affected.

Foreign Currency Risk

Through March 31, 2011, all sales transactions were denominated in U.S. dollars. Beginning in the fourth quarter of 2010, we had an immaterial amount of purchase transactions denominated in Euros. Accordingly, we have limited exposure to foreign currency exchange rates and do not currently enter into foreign currency hedging transactions. In the future, as we expand our international operations, we may have greater exposure to foreign currency exchange risk which we intend to mitigate through foreign currency hedging transactions. However, these activities may be limited in the protection they provide us from foreign currency fluctuations and can themselves result in losses.

BUSINESS

Overview

We have pioneered a fundamentally new inverter technology for the solar industry that increases energy production, simplifies design and installation, improves system uptime and reliability, reduces fire safety risk and provides a platform for intelligent energy management. To date, the solar industry has relied on the traditional central inverter approach to power conversion that has largely remained unchanged for the past two decades. We have built from the ground up a semiconductor-based microinverter system that converts energy at the individual solar module level and, combined with our proprietary networking and software technologies, provides advanced energy monitoring and control. Given the significant advantages over traditional central inverters, we believe that microinverter solutions will become the standard for residential and commercial solar. We created the microinverter category and have grown rapidly since our first commercial shipment in mid-2008, with more than 750,000 units shipped through May 31, 2011, representing over an estimated 25,000 solar installations.

We were the first company to commercially ship microinverter systems in volume. Our products have been installed in all 50 U.S. states and eight Canadian provinces, and we are rapidly taking market share from traditional central inverter manufacturers. For example, in California, the largest single solar market in the U.S., based on estimates by SEIA, our market share of the residential solar photovoltaics, or PV, inverter market has increased from 0% in mid-2008 to almost 20% during the first half of 2011 according to CSI.

California Residential Market Share (July 2008 – May 2011)
Enphase Energy Market Share – 3-Month Moving Average Based on Megawatts

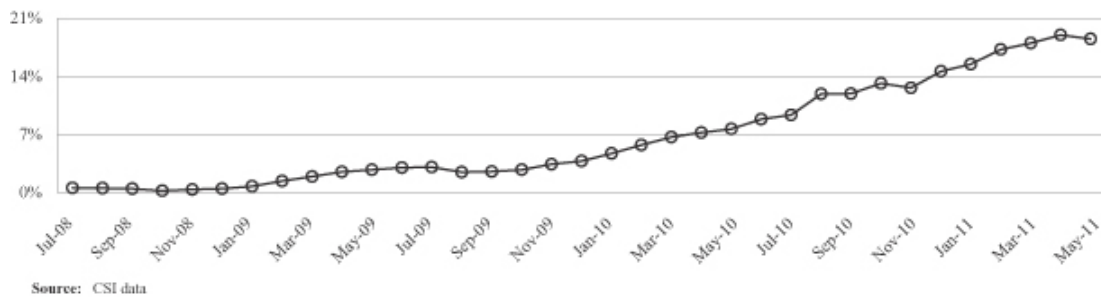

Our microinverter solution brings a system-based, high technology approach to solar energy generation leveraging our design expertise across power electronics, semiconductors, networking and software technologies. Our microinverter system consists of three key components: the Enphase microinverter; the Envoy communications gateway; and the Enlighten web-based software:

- Our industry leading Enphase microinverter delivers efficient and reliable power conversion at the individual solar module level by introducing digital architecture that incorporates a custom ASIC, specialized power electronics devices and an embedded software subsystem that optimizes energy production from each module and manages the core ASIC functions.
- Our Envoy communications gateway is installed within the system owner's home or business and serves as a networking hub that collects data from the microinverter array and sends the information to our hosted data center.
- Our Enlighten web-based software collects and processes this information to enable system owners to monitor and analyze the performance of their solar PV system down to the individual solar module level. Enlighten also provides an online portal specifically designed for installers to enable them to track and manage all of their Enphase enabled projects.

[Table of Contents](#)

Together, our Enphase microinverter, Envoy communications gateway and Enlighten web-based software function as a single unified system that enhances energy production, simplifies design and installation, reduces costs, increases reliability and uptime, reduces fire risk, and provides the ability to monitor performance down to the module level in real-time compared to central inverter system. With an Enphase microinverter system, we believe system owners can achieve a higher return on investment over the lifetime of the solar system.

We sell our microinverter systems primarily to distributors who resell them to solar installers. We have developed a network of over 2,500 installers in North America through May 31, 2011, and we are adding approximately 100 new installers per month. We also sell directly to large installers as well as through OEMs and strategic partners. We have achieved substantial growth since we commenced commercial production in 2008. The majority of our revenue has been generated by sales within the United States. Sales to customers in Canada commenced in 2009 and accounted for approximately 13% of our total revenue in 2010. In early 2011, we established sales offices in France and Italy. Our total revenue was \$1.7 million, \$20.2 million, and \$61.7 million for fiscal years 2008, 2009, and 2010, respectively, and was \$11.6 million and \$18.1 million for the first three months of fiscal 2010 and 2011, respectively.

Industry Overview

Solar Energy Is a Large and Growing Industry

According to The Datamonitor Group, the global electricity market represented \$1.6 trillion in annual consumption in 2009. With global electricity needs expected to increase by approximately 45% from 2009 to 2035, according to the U.S. Department of Energy, coupled with increasing energy security and environmental concerns associated with traditional fossil fuels, suppliers and users of electricity are seeking more renewable sources of energy. Among renewable sources of electricity, solar energy has the most potential to meet the world's growing electricity needs. The global solar PV market witnessed rapid growth from 7 GW, or \$38 billion, of installed capacity coming online during 2009 to 17 GW, or \$75 billion, in 2010, and is expected to grow to 41 GW in 2015, representing a compounded annual growth rate of 19%, according to iSuppli.

The solar PV market has grown in Europe, largely driven by subsidies that have been implemented by numerous countries to develop a renewable energy industry and create jobs at the local level. In Europe, these subsidies take the form of FiTs, which guarantee eligible renewable electricity generators a premium price for the electricity they produce over a long term time horizon. The U.S. solar PV market is growing rapidly, as there are both federal incentive programs for solar energy available such as the Business Energy Investment Tax Credits, as well state-level implementations of Renewable Portfolio Standards and other state, local and utility subsidies and other programs geared toward encouraging the development of solar energy. The U.S. solar PV market grew over 100% in 2010 over 2009 and is projected to become the largest solar PV market in the world by 2015 by number of annual installations as the price of solar approaches the price of other electricity sources on the grid. Almost 1 GW was installed in the United States across 50,000 homes, businesses and utilities in 2010, according to iSuppli.

Smaller solar installations typically attract higher FiT rates as the costs are higher and installed by residential owners rather than financial investors. Recent changes to local FiT rules by governments in Italy, Germany and Spain are favoring the smaller installations even more than before. As a result, growth in the global solar industry is expected to shift from utility-scale and commercial solar greenfield installations to residential and commercial rooftop solar installations.

Solar Industry Segmentation

The solar PV market consists of two primary on-grid solar markets: distributed solar systems for residential and commercial buildings; and centralized large scale solar PV installations owned and operated by utilities. Residential deployments are typically small (<10 kW) roof-mounted installations to supplement power usage to residential dwellings. Commercial installations are small to large (>10 kW to 1 MW) deployments, typically also roof-mounted, to supplement electricity requirements of commercial buildings such as retail stores, apartment complexes, industrial manufacturing facilities and state and federally owned government office buildings. Utility-scale solar PV installations are very large (several MWs) PV arrays that are typically ground-mounted and located in remote regions that receive high solar irradiation, such as the American desert southwest region, and generate significant amounts of electricity that is transported by utility transmission lines to load centers. In 2010, the residential and commercial markets represented 72% of the U.S. solar inverter market, according to SEIA.

Typical Solar System Costs

There are four key components of the cost of installing a typical solar PV system: solar modules; installation; DC to AC inverters; and cabling and other. Solar modules represent 59% of the total cost. Installation represents 25% of the total cost and includes the costs of specialized solar installation and design professionals to construct the solar system at the home or business. The inverter represents 10% of the total cost and is used to transform the DC power generated by the solar module array to standard AC power used in homes and buildings. Finally, cabling and other represent 6% of the total cost and include wiring systems used to integrate the solar modules into the electrical systems. The wiring systems include disconnects for the DC side of the inverter, ground-fault protection, and over current protection for the solar modules.

Breakdown of Total Solar System Costs
% of Total System Cost

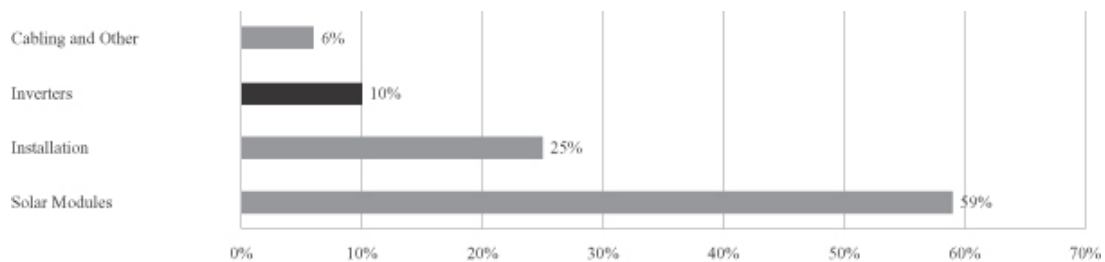

Source : iSuppli data

Inverter Industry

Historically, traditional central inverters have been the only inverter technology used for solar PV installations. In an installation consisting of a traditional central inverter, the solar PV modules are connected in series strings. In a large installation, there are multiple series strings connected in parallel. The aggregated voltage from each of these strings is then fed into a large central inverter. The central inverter performs two key functions: (i) it establishes a maximum power point tracking, or MPPT, operating point for the system and (ii) converts power from high-voltage DC to grid-complaint AC. Since the beginning of solar PV industry, traditional central inverters have continued to use high-voltage analog technologies to convert DC to AC requiring complex design and string calculations to ensure safe and reliable system operation. In 2010, 99% of the GW volume of solar inverters deployed were traditional central inverters. The worldwide market for inverter technology in 2010 was almost 20 GW, or \$5.5 billion, and the market is expected to grow to 34 GW, or \$8.2 billion, by 2014, according to IMS Research.

Traditional Central Inverter Architecture

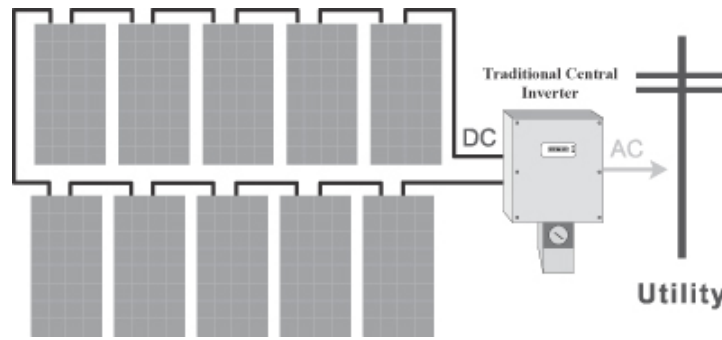

Challenges of Traditional Central Inverters

As compared to microinverter systems, we believe that traditional central inverters have a number of design and performance challenges limiting innovation and their ability to reduce the cost of solar systems, including the following:

- *Productivity limits.* If solar modules are wired using a traditional central inverter—such that a group or “string” of modules are wired in series—an entire string’s output is limited by the output of the lowest-performing module. If one module is dirty, shaded, or is not operating to its maximum specification, the whole string’s output is lowered to the level of that module resulting in a loss of energy production. In addition, due to string design requirements, central inverters also limit the design and site selection for solar PV arrays, particularly in rooftop applications. As such, many of today’s central inverter installations are not maximizing energy production and, therefore, the system owners are not realizing the full benefit of their investment.
- *Reliability issues.* Traditional central inverters are the single most common component of solar installations to fail, resulting in system downtime and adversely impacting total energy output. If a central inverter fails, the downtime is significant since the entire array will not be producing energy until the inverter is repaired or replaced. The high-DC voltage and power levels processed by central inverters result in higher inverter failure rates and shorter product life due to higher stress on components. As a result, central inverters typically carry warranties of only 5-10 years while solar modules have warranties of 25 years, potentially requiring several inverter repairs or replacements over the life of the solar PV system.
- *Complex design and installation requirements.* The central inverter-based solar PV installation requires greater effort on the part of the installer, both in terms of design and on-site labor. Central inverter installations require string design and calculations for safe and reliable operation, as well as specialized equipment such as DC combiners, conduits and disconnects. In addition, the use of high-voltage DC requires specialized knowledge and training and safety precautions to install central inverter technology. Installers must also know and inventory a family of inverters to manage different solar PV installation sizes. Once installed, the system is not expandable without a purchase of another central inverter. Central inverters also tend to be heavy, bulky and noisy and often have to be protected and located outside of plain view.
- *Lack of monitoring.* The majority of solar installations with central inverter technology offer limited monitoring capabilities. A failure of the central inverter will often go unnoticed for days or even weeks. Even if some form of monitoring is available, it is limited to the inverter and cannot monitor the health and performance of individual solar modules. Therefore, if a module fails or is not performing to specification, the resulting loss of energy can go unnoticed.

[Table of Contents](#)

- *Safety issues.* Central inverter solar PV installations have a wide distribution of high-voltage DC wiring. If damaged, DC wires can generate sustained electrical arcs, reaching temperatures of more than 5,000 °F. This creates the risk of fire for solar PV installation owners and injury for installers and maintenance personnel. In fact, due to an increasing number of incidents, the 2011 National Electric Code now requires all inverters to be able to detect and interrupt DC arc faults.

These challenges of traditional central inverters have a direct impact on the cost and expected return on investment of solar installations to both installers and system owners:

- *Installer.* Solar system installers aim for simple installation design, fast installation times and maximum system performance and predictability. The installation of high-voltage DC central inverter technology, however, requires significant preparation, precautionary safety measures, time-consuming string calculations, extensive design expertise and specialized installation equipment, training and knowledge. Together, these factors significantly increase complexity and cost of installation and limit overall productivity for the installer.
- *System owner.* Solar system owners aim for high energy production, low cost, high reliability and low maintenance requirements, as well as reducing fire risks. With central inverter solutions, owners often are unable to optimize the size or shape of their solar PV installations due to string design limitations, experience performance loss from shading and other obstructions, can face frequent system failures and lack the ability to effectively monitor the performance of their solar PV installation. In addition, central inverter installations operate at high-voltage DC which bears significant fire risks. Further, central inverter installations can affect architectural aesthetics of the house or commercial building.

Our Solution

We design, develop, manufacture and sell the leading microinverter system for the solar PV industry. To date the solar industry has relied on the traditional central inverter approach that has largely remained unchanged for the past two decades. We have built from the ground up a semiconductor-based microinverter system that converts energy at the individual solar module level and, combined with our proprietary networking and software technologies, provides advanced energy monitoring and control. This is vastly different than the central inverter approach that can only convert energy of the entire array of solar modules from a single high voltage electrical unit, and lacks intelligence about the energy producing capacity of the solar array. The different approaches are depicted in the figure below.

Traditional Central Inverter System vs. Microinverter System

Traditional Central Inverter Approach

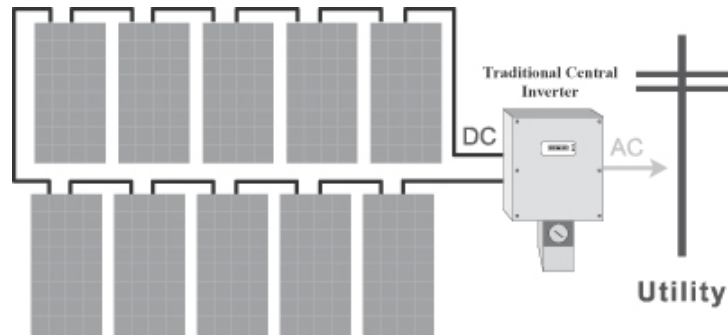

Enphase Microinverter System

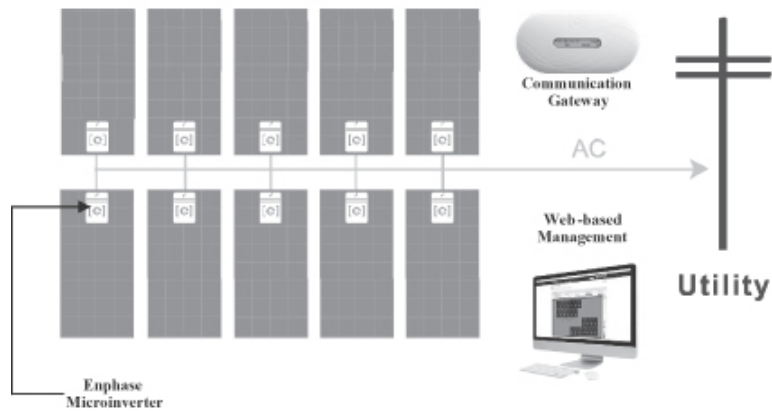

[Table of Contents](#)

Our microinverter solution brings a system-based, high technology approach to solar energy generation leveraging our design expertise across power electronics, semiconductors, networking, and embedded and web-based software technologies. Our microinverter system consists of the following hardware and service components: our Enphase microinverter; our Envoy communications gateway; and our Enlighten web-based software service. Since inception approximately 99% of our net revenues have been derived from the sale of hardware products.

- Our industry leading Enphase microinverter delivers efficient and reliable power conversion at the individual solar module level by introducing a digital architecture that incorporates custom ASICs, specialized power electronics devices and an embedded software subsystem that optimizes energy production from each module and manages the core ASIC functions.
- Our Envoy communications gateway is installed within the system owner's home or business and serves as a networking hub that collects data from the microinverter array and sends the information to our hosted data center.
- Our Enlighten web-based software collects and processes this information to enable system owners to monitor and analyze the performance of their solar PV system at the individual solar module level. Enlighten also provides an online portal specifically designed for installers to enable them to track and manage all of their Enphase enabled projects and monitor and analyze the performance of their systems. Historically, Enlighten service revenue has represented less than 1% of total revenues in any given reporting period.

Together, our Enphase microinverter, Envoy communications gateway and Enlighten web-based software function as a single unified system that enhances energy production, simplifies design and installation, reduces costs, increases system uptime and reliability, reduces fire safety risk, and provides the ability to monitor performance at the individual module level in real-time. With an Enphase microinverter system, we believe solar system owners can achieve a higher return on investment over the lifetime of the solar system than would be achieved using a traditional central inverter approach.

Key elements of our solution include:

- *Productive—Superior Energy Production.* Our microinverter system enables the maximum possible energy production from each module, overcoming a fundamental design limitation of central inverters which are limited by the lowest performing module. We believe that our microinverter systems achieve higher energy production and can generate superior returns on investment relative to central inverter solutions for system owners.
- *Reliable—Longer Life and No Single Point of Failure.* Reduction of component count, primarily through semiconductor integration in our microinverter, allows us to design a reliable system that can withstand harsh environmental conditions. In addition, because we process low voltages and power levels, our components experience less stress and last longer than traditional central inverters. Furthermore, the distributed architecture of our microinverter system improves system uptime. If a microinverter unit fails, it results in lost energy production from a single solar module only and not the entire array. We estimate that our microinverter systems achieve system uptimes of over 99.8%. Enphase microinverters are fully certified and comply with certain electrical standards, such as UL 1741 of the National Electrical Code standard, or NEC, and safety standards, such as CSA in Canada or UL in the United States. We offer a 25-year limited warranty on our latest generation microinverter and 100% system uptime guarantee.
- *Simple—Ease of Design and Installation.* Using microinverter technology, an installer can design a system of any size and any roof configuration with a simple modular approach. After initial installation, the system can be easily expanded by even a single module. Our single inverter per module approach converts directly to AC and enables a simpler, all AC design, eliminating the extra cost, training and complexity associated with typical high voltage DC implementation. Without these complexities, installation of microinverter technology is greatly simplified, improving installers'

[Table of Contents](#)

productivity. This also enables a new class of solar installer, such as electricians and general contractors. Finally, our microinverters are installed on the roof and hidden from view, with minimal impact to the aesthetics of a home or building.

- *Smart—Module-Level Monitoring and Analytics.* Our microinverter system allows us to collect energy production information in real time on a per solar module basis. This enables powerful system analytics and allows Enphase to offer installers and system owners visibility into how their system is performing and the ability to continuously optimize energy production—which is particularly important when operating commercial solar installations. Such services include system performance and diagnostics, benchmarking, as well as system and module alerts and fault statistics.
- *Safe—“All AC” Solution.* Perhaps most important to both installers and system owners, microinverters are safer because they process low DC voltages relative to central inverters. High voltage arc faults associated with traditional central inverter are the leading cause of fires of solar PV installations. Microinverter technology mitigates this safety risk.

Due to the benefits of our solution, we believe solar installers achieve greater productivity and competitive differentiation over installers of traditional central inverter solar PV installations, and the solar system owner achieves a higher return on investment with an Enphase microinverter system over the life of the solar system.

LCOE Case Studies

The levelized cost of energy, or LCOE, analysis in the two Enphase case studies highlights the premium value proposition of Enphase microinverter systems over traditional central inverters.

Residential Installation

The solar installation illustrated below is a residential solar installation in Ontario, Canada and experiences moderate sunshine. It has a standard roof line with two arrays, maximizing the number of solar panels and achieving the desired 7.5 kW DC system size. Some shading exists, but did not factor significantly in determining whether to use an Enphase microinverter system over a traditional central inverter.

Residential Installation with an 7.5 kW DC System



IRR/LCOE Comparison

	Enphase Microinverter	Traditional Central Inverter
Total System Cost⁽¹⁾	\$43,364	\$41,838
Modules and Racking ⁽²⁾	\$25,500	\$25,500
Inverter ⁽²⁾⁽³⁾	\$6,650	\$5,270
Design, Permit and Other	\$1,400	\$1,600
Profit and Sales Tax	\$9,814	\$9,468
California Energy Commission (CEC) Efficiency	95%	96%
System Uptime	99.8%	98%
Inverter Warranty	15 years	10 years
Additional Energy Harvest	5%	N/A
\$/Watt DC (Total System Cost)	\$5.78	\$5.53
LCOE⁽⁴⁾	\$0.18/kWh	\$0.19/kWh
IRR⁽⁴⁾	9.4%	8.4%

Source: Enphase and installer estimates based on 7.5 kW DC system size

- Note:
- (1) = Cost is to the system owner
 - (2) = Labor cost included
 - (3) = Inverter cost includes inverter, cabling and monitoring equipment
 - (4) = PVWatts estimated energy production. 20-year life. Includes incentives and rebates

The illustration above compares the total cost of the system as well as LCOE and internal rate of return, or IRR, of the two approaches. The use of 33 individual distributed Enphase microinverters rather than a single central inverter results in a higher upfront cost; however, the additional energy harvest and improved uptime results in an improved LCOE and IRR. Both LCOE and IRR are calculated over a 20-year operating period.

Small Commercial Installation

The 53.5 kW DC small commercial solar installation illustrated below consists of 228 solar modules. The building is in Arizona and experiences high sunshine. Some of the solar modules experience some shade from a small center tower visible in the picture. A single traditional central inverter system was also proposed as an alternative. The curved roof presented challenges for a central inverter requiring more complicated string design and sizing which increased the design time and cost. Because of the size of the installation, the central inverter required additional equipment to aggregate cable runs from multiple DC strings.

Small Commercial Installation with a 53.5 kW DC System

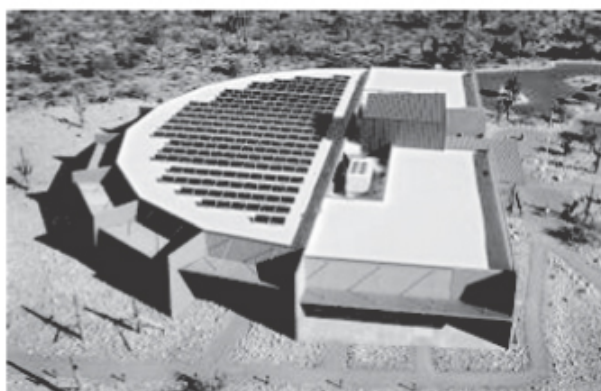

Photo by Tom Storks

IRR/LCOE Comparison

	Enphase Microinverter	Traditional Central Inverter
Total System Cost⁽¹⁾	\$267,758	\$259,766
Modules and Racking ⁽²⁾	\$155,150	\$155,150
Inverter ⁽²⁾⁽³⁾	\$46,013	\$36,830
Design, Permit and Other	\$6,000	\$9,000
Profit and Sales Tax	\$60,595	\$58,786
CEC Efficiency	95%	96%
System Uptime	99.8%	98%
Inverter Warranty	15 years	10 years
Additional Energy Harvest	6%	N/A
\$/Watt DC (Total System Cost)	\$5.00	\$4.86
LCOE⁽⁴⁾	\$0.11/kWh	\$0.13/kWh
IRR⁽⁴⁾	16.8%	15.4%

Source: Enphase and installer estimates based on 53.5 kW DC system size

Note: (1) = Cost to the system owner

(2) = Labor cost included

(3) = Inverter cost includes inverter, cabling and monitoring equipment

(4) = PVWatts estimated energy production. 20-year life. Includes incentives and rebates

[Table of Contents](#)

The Enphase microinverter system, while more costly upfront, was simpler to design and did not require additional equipment. It also achieved the specific aesthetic goals of the building owner. Furthermore, the solar installation is monitored and a kiosk in the building lobby displays the Enlighten web-based monitoring system.

Competitive Strengths

We believe the following combination of capabilities and features of our business model distinguish us from our competitors and position us well to capitalize on the expected growth in the solar market and to become a global leader in the broader solar power industry:

- *First to Market and Rapid Adoption.* Enphase created the microinverter product category, developed strong brand recognition and offers a proven microinverter solution. Since the shipment of the first commercial product in 2008, we have successfully introduced three microinverter generations, raising average conversion efficiency from 94% to 96%, power from 175 to 215 watts, and have over 750,000 units shipped through May 31, 2011. We believe that this early-mover advantage and proven ability to innovate quickly will continue to allow us to build on our leading market position, and expand our product portfolio and market reach.
- *System Approach.* We built our solution from the ground up and employ a system approach with a powerful combination of digital electronics, networking and software technologies. Our system offers significant design and operating benefits beyond the core power conversion functionality underlying our microinverter. By integrating the Enphase microinverter technology with Envoy, our proprietary communications gateway, and our Enlighten web-based software, we deliver real-time module-level monitoring and analytics. Our R&D organization includes over 75 engineers and is divided equally across critical power electronics and semiconductor, powerline communication and networking, and software design disciplines.
- *Strong Focus on Technology and Research and Development.* Our proximity to Silicon Valley and the past experience of our founders and executive officers in the technology industry have enabled us to recruit engineers with strong skills in power electronics, semiconductors, Powerline communications and networking, and software design, which we have complemented with significant solar industry expertise from other members of our team. We have a strong research and development team and a portfolio of intellectual property, or IP, spanning across the previously mentioned technology areas. We have nine issued U.S. patents, one issued non-U.S. patent, 45 pending U.S. patent applications and 85 pending non-U.S. counterpart patent applications. We believe our combination of engineering, management and operational expertise from the high technology and the solar industry will help us to continue to rapidly innovate and cost efficiently introduce new microinverter solutions.
- *Field-Proven Reliability.* According to data from Westinghouse, microinverters are 45 times more reliable than central inverters. With over 750,000 of our microinverter units shipped across North America, we have established industry leading reliability as represented by a MTBF rate of approximately 331 years, or 0.3% per year. We use proven technologies and design techniques to achieve higher reliability. In addition, we have designed and developed proprietary product verification test software and equipment and employ a team of 30 engineers that ensures product quality and long-term reliability. As the result of ongoing advances in our microinverter system technology, we are confident enough in our product to offer our latest-generation microinverter product with a 25-year limited warranty consistent with the expected life of the solar PV installations.
- *Capital Efficient and Scalable Manufacturing.* Our design and R&D philosophy leads to a product design that enables us to employ a manufacturing model that we believe is superior to that of central inverter manufacturers. Our digital architecture allows us to leverage semiconductor integration to reduce part count in a microinverter unit, which we believe will allow us to significantly reduce manufacturing costs. Our microinverter is built on a single PC board allowing for a greater degree of automation in the manufacturing process and further reducing manufacturing cost. In contrast,

traditional central inverters have multiple PC boards and complex internal wiring requiring a greater amount of manual construction and thereby increasing the cost of manufacturing. We outsource all of our hardware manufacturing to manufacturing partners, including Flextronics. Our model results in a low fixed-cost structure and reduced capital expenditure and working capital requirements. In addition, our model provides greater flexibility to take advantage of market opportunities. For example, we recently expanded manufacturing to Canada to qualify for local content-based incentives and did so in less than three months with minimal capital expenditure. By expanding our production volume, we believe we can take advantage of economies of scale, enabling further reductions in the price per watt of our microinverter systems.

- *Rapidly Expanding Distribution Channels.* Since we shipped our first microinverter system in 2008, our base of installers has grown to over 2,500 installers in North America by May 31, 2011, and we are currently adding new installers at the rate of approximately 100 each month. Our microinverter technology is enabling new channels and routes to market, including through opening new and larger distribution channels. For example, we have a supply and distribution agreement with Siemens Industry, Inc. to re-sell co-branded Enphase microinverter products and related solutions through Siemens' network of over 50,000 North American electrical contractors.
- *Intense Focus on Customer Service for Installers.* We believe we have cultivated an organizational focus on installer satisfaction that differentiates us from central inverter manufacturers, resulting in a high level of installer retention and "repeat" business. We work very closely with our installers to provide assistance necessary to help them across every aspect of the design and installation process. We provide full-day in-person training and online training to approximately 3,000 installers per year. Our system allows us to remotely design, activate, update, monitor and troubleshoot all of our connected solar installations and analyze energy production trends, enabling higher levels of customer satisfaction.

We believe these competitive strengths will enable us to maintain our leadership position as the residential and commercial solar market shifts from traditional central inverter to microinverter technology, and central and new players enter this market.

Our Strategy

Our objective is to continue to be the leading provider of microinverter systems for the solar industry worldwide and to accelerate the shift from traditional central inverters to microinverter technology. Key elements of our strategy include:

- *Continue to Penetrate Our Core Markets.* We intend to capitalize on our technology leadership and growing momentum with installers and owners to further our market share position in our core markets in the United States and Canada. We currently focus our product offering for application in the residential and commercial markets. We plan to expand our sales and marketing and customer service efforts to increase our installer base and, in addition, extend enhanced field engineering capabilities to several larger direct commercial solar installers. In addition, our microinverter technology enables new entrants to become solar installers with minimal training. A majority of our installers are new to the solar industry and are installing solar modules for the first time. We intend to continue to bring new installers to the solar industry and expand our installer base.
- *Enter New Geographic Markets Rapidly.* We intend to expand into new markets with new products and local go-to-market capabilities. We have recently opened offices in Europe to serve France, Italy and the Benelux region. We intend to open a sales office in China to support local solar module partners, and to develop the residential and commercial solar opportunity for microinverter systems in Asia. We opened our new offices to enable us to diversify our customer base, gain market share in worldwide solar markets and reduce our geographic dependence, and enable us to become a global microinverter vendor with global market reach.

[Table of Contents](#)

- *Increase Power and Efficiency and Reduce Cost per Watt.* Our engineering team is focused on continuing to increase average power conversion efficiency above 96% and AC output power beyond 215 watts. We intend to continue to leverage our semiconductor integration, power electronics expertise and manufacturing economies of scale to further reduce cost per watt. For example, our M215 Series microinverter is based on our next generation ASIC, which increases semiconductor content and integration of components, while at the same time lowering manufacturing costs and increasing conversion efficiency and reliability, improving the overall return on investment of the solar installation. We believe we are on a steeper cost per watt reduction curve relative to central inverters, enabling us to further penetrate the market.
- *Expand Our Technology Leadership.* We distinguish ourselves from other inverter companies with our system-based and high-tech approach, and the ability to leverage strong research and development capabilities. We have nine issued U.S. patents, one issued non-U.S. patent, 45 pending U.S. patent applications and 85 pending non-U.S. counterpart patent applications. Six of our issued U.S. patents directly relate to DC to AC power conversion for alternative energy power systems. The remaining three cover anti-islanding safety technology, measurement of grid voltage and monitoring circuits coupled to AC lines, respectively. Our design capabilities have allowed us to successively increase efficiency, power output and reliability, while reducing the cost per watt of our microinverter solution. As of May 31, 2011, we employed 76 engineers focused on design and development of our microinverter system and a dedicated group of power-electronics engineers employing proprietary system-modeling and simulation tools and specifying new components in advance of our next generation architecture. Further, we are working on a variant of our current-generation microinverter that enables an “AC module” for direct attachment of the microinverter to the backsheet of the solar modules, which further reduces installation cost and time, and we are developing our fourth-generation product designed to lower costs and facilitate our expansion strategy into large commercial solar installations and new geographies.
- *Extend Our Product Offering for Larger Commercial and Utility-Scale Installations.* We intend to expand our product offering by introducing new microinverter systems targeted at larger commercial and utility-scale installations. We expect these market segments to become a significant revenue opportunity for Enphase in the future. We also have programs in place focused on expanding our Enlighten web-based software platform and our networking capabilities for commercial and utility-scale installations.
- *Develop a Smart Energy Management Platform.* We intend to build upon our strong position as the leading supplier of microinverter and energy management systems to expand beyond solar and to create a smart energy management platform for integrated smart energy devices and services. For example, our smart thermostat device integrates with the Enlighten web-based software, allowing owners to manage their solar PV installations and control their heating and cooling system from a single web-based platform. We see opportunities beyond the thermostat and intend to develop additional energy management devices and services in the area of energy consumption monitoring and enable the growing network of solar installers to become energy consultants and service providers.

Our Products

Our microinverter system consists of three individual product components: our Enphase microinverter, Envoy communications gateway and Enlighten web-based software. These elements function as a single unified system that enhances energy production, simplifies design and installation, reduces costs, increases system uptime and reliability, reduces fire safety risk, and provides the ability to monitor performance down to the module level in real-time. Each of these elements and the specific products in our offering are displayed and described below:

Enphase System



1. Enphase Microinverter

- Maximizes energy production
- Installed on the racking beneath each solar module

2. Envoy Communications Gateway

- Monitors each module and microinverter in the array
- Connects to Enlighten servers through standard Internet router

3. Enlighten Software

- Continuously analyzes and reports the health and performance of the solar array
- Allows for remote system analysis and troubleshooting

Source: Enphase Energy

Enphase Microinverter

Our microinverter converts the DC output from a single solar module into grid compliant AC. It delivers efficient and reliable power conversion at the individual solar module level through a purpose built digital architecture that incorporates custom ASICs, specialized power electronics devices, custom magnetics, powerline communications, or PLC, and networking technology and an embedded software subsystem that optimizes energy production from each module and manages the core ASIC functions. We offer two microinverter product lines today:

- *Second Generation Microinverter.* Our second generation microinverter, including the M190, M210 and a twin pack version of the M190, the D380, has an average power conversion efficiency of 95%. It supports mono- and multi-crystalline solar modules from over 50 module vendors in 60-cell and 72-cell formats with nameplate power ratings of up to 240W STC. The maximum circuit size for this product is up to 15 microinverters. Each circuit is terminated directly to the AC load center using standard AC cabling. The microinverter is certified to UL1741 as a utility-interactive inverter, the U.S. and Canadian standard for static inverters and charge controllers for use in solar PV power systems, listed for sale in North America. We provide a 15-year limited warranty for our M190, M210 and D380 series microinverters.
- *Third Generation Microinverter.* Our third generation microinverter, the M215, is based on our next generation ASIC and increases the maximum rated AC output power to 215W, with average power conversion efficiency of 96%. Our M215 microinverter addresses 60-cell solar modules with nameplate power ratings of up to 260W STC. In addition, it incorporates a new, proprietary AC cable that increases the compatible system circuit size to up to 17 microinverters, allowing for greater installation flexibility and simplified cabling on the microinverter unit itself, reducing both cost and size. In addition to

[Table of Contents](#)

receiving UL1741 certification, it has also received the European VDE and CE certifications for sale in Europe. We offer a 25-year limited warranty for our M215 series microinverter.

Both our M190 and M215 series microinverters are installed on the roof and hidden from view, with minimal impact on the aesthetics of a home or building.

We support our microinverters with our Entrust program, which provides system owners with a 100% uptime guarantee. Under the Entrust program, we reimburse the system owner for any lost energy for up to one month if a microinverter unit should fail. In addition to replacing a microinverter unit under warranty, we proactively notify the installer, and ship an advance replacement unit free of charge.

Envoy Communications Gateway

Our Envoy communications gateway is the networking hub for the microinverter array. It collects data from the solar module via our proprietary PLC technology and delivers it to our hosted, Enlighten web-based software application through an Ethernet connection to a broadband Internet router. The Envoy communication gateway can also provide critical information if no broadband connection is available through its imbedded web interface that provides configuration, control and system state information and is accessible by computer through an Ethernet connection and through its LCD display that provides high level status information. In addition, the Envoy communications gateway supports Zigbee, a low power wireless mesh communication protocol for communication with our Environ smart thermostat.

Enlighten Software

Installers and system owners use our Enlighten web-based software, which is included with the Envoy communications gateway, to track and display daily, weekly and annual energy production information. Installers also use the Enlighten installer dashboard to manage multiple systems from a single screen. In addition, we use Enlighten to activate a system and remotely troubleshoot, analyze and diagnose system problems. System owners and installers access our Enlighten web-based software through the following interfaces:

- *Enlighten Monitoring Service.* The Enlighten web-based monitoring service provides real-time information to the installer and system owner on the energy production of the solar array. This service can be accessed by installers or system owners from any personal computer or a mobile device with a web browser.
- *Installer Dashboard.* The installer dashboard is a web-based portal that is the first page each installer sees when he accesses his Enlighten account. It allows an Enphase installer to easily customize the page so several sites under management can be consolidated into a single view. In addition, we use the installer dashboard to communicate with our installers, with industry news, product updates and Enphase community postings.

Environ Smart Thermostat

Our Environ smart thermostat enables system owners to monitor and control heating and cooling of a home or business. This smart thermostat integrates with our Envoy communications gateway and our Enlighten web-based software. Users can control the temperature of their homes from anywhere they have access to a web browser, including a mobile device.

Our Technology

Three years after the introduction of our first generation microinverter system, we have successfully commercialized the technology, creating a new product category. Our system has the following critical attributes:

- Converts DC power from the solar module into grid-compliant AC power efficiently and with minimal loss;
- Achieves low cost per watt and LCOE;

[Table of Contents](#)

- Provides a robust communications network enabling real-time management of the solar PV installation;
- Ensures a high level of safety both during and after installation;
- Connects to the grid safely and to specification;
- Ensures long-term durability in harsh outdoor environments; and
- Manufacturable in high volumes and at high yields.

The critical technologies enabling our system are in the areas of power electronics and magnetics, semiconductors, powerline communications and networking, and embedded and web-based software. An overview of each of these technology elements and the essential function each play in the overall microinverter system is described below:

Enphase Microinverter

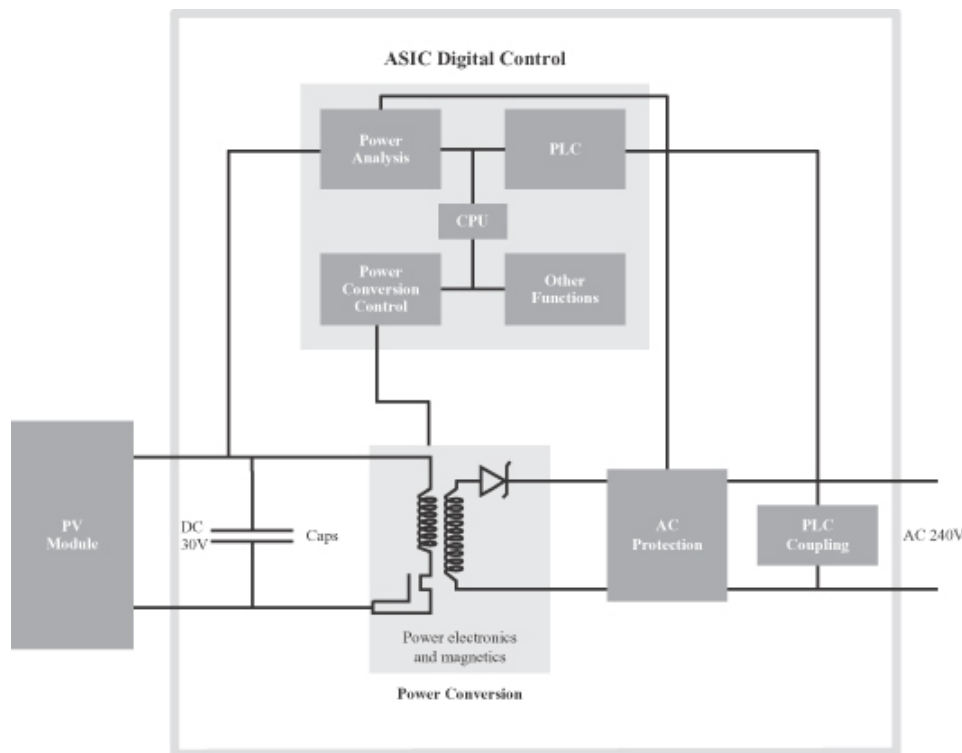

Source: Enphase Energy

Power Electronics

The performance and efficiency of our Enphase microinverter is driven by its core architecture and design. Key functions of the design include specialized power electronics, custom magnetics and advanced ASIC-based digital control that enable our Enphase microinverter to efficiently convert DC from the solar module to grid-compliant AC at optimal efficiency. Our Enphase microinverters utilize a sophisticated predictive model to accomplish this conversion and output a digitally synthesized AC waveform. Our Enphase microinverter conforms to safety standards as defined by UL1741 in North America and VDE0126 in Europe. Our microinverters also analyze both the DC and AC electrical characteristics of the system to determine safe and reliable operation.

[Table of Contents](#)

We also utilize proprietary simulation and validation tools capable of modeling most elements of our hardware solution to accurately predict performance prior to hardware design and fabrication or, alternately, to identify and optimize critical design parameters. We use these simulation and validation capabilities to develop new and more sophisticated control algorithms, and to reduce our engineering investments and time to market.

Magnetics

Microinverter power conversion efficiency, cost and reliability are a function of the magnetics designed in the system. We design and utilize custom magnetic cores and windings to maximize the power density of a chosen magnetics core geometry, which in addition to high performance and low cost allows us to achieve improved thermal performance, reliability and a very low mechanical profile, an important criteria for mounting underneath or onto a solar module. We work to optimize pin spacing and other electrical properties to ensure we meet stringent regulatory requirements for electromagnetic emission.

Semiconductors

Unlike prior generation microinverters or current central inverters, the Enphase microinverter is a microelectronics device built around a digital architecture. Around 30% of the bill of materials of each Enphase microinverter is composed of semiconductor content. We are on our fifth generation of ASICs responsible for all critical digital control functions of our microinverter, including detailed power analysis, digital control of the power conversion subsystem and powerline communications and networking. Unlike traditional inverters, our microinverters process low amounts of power (215W AC) and switch low DC voltages (30 volts DC). These features, combined with the ability to leverage low cost silicon in standard packages and pin counts, make possible a high degree of semiconductor integration. As a result, much of the functionality of our Enphase microinverter can be integrated into a standard CMOS ASIC instead of discrete electrical components, resulting in lower costs and a simplified overall hardware design. Our intent is to leverage semiconductor integration in the solar industry in the same fashion that semiconductors benefited the personal computer, telecommunications and consumer electronics industries, delivering more functionality and lower costs.

Our ASIC performs the critical power analysis and power conversion control functions of the microinverter. The power analysis function processes critical sensory input from the solar module and the AC grid, such as voltage and frequency and other information that enables the precise control of the synthesized output AC waveform. Our ASIC also provides the advanced digital control and state machine logic that controls the power conversion function. A high speed power sequencer that controls the transfer of energy from the DC side of the system to the AC side at very high frequency drives the power metal-oxide-semiconductor field-effect transistors, or MOSFETs, in our microinverter. In addition, our digital control system uses an innovative predictive control technology that allows the solar PV installation to anticipate and adapt to changing operating conditions and protect against grid anomalies, such as power surges.

Powerline Communications and Networking

A powerline communications networking link exists between each microinverter in the array and the Envoy gateway. Our powerline communications link uses a proprietary networking technology developed by Enphase utilizing the same AC wiring to transmit and receive data between devices as is used to distribute electricity.

Our proprietary PLC technology is integrated into our custom ASIC. Our third generation microinverter, the M215, integrates our most advanced PLC technology, which offers improved modulation techniques and additional carrier frequencies to enhance performance. In addition, it increases the number of devices supported through more powerful data processing capabilities, and extends the range supported between devices with superior signal processing. Finally, it provides reduced communications latency with more frequent polling of end devices and improved link reliability through advanced error detection and correction.

[Table of Contents](#)

An Enphase powerline communications installation must support a large number of microinverter endpoints transmitting a small amount of information on an infrequent basis over a dated electrical infrastructure with appliances, power strips, pumps, air conditioners, computers, televisions, and other electrical noise competing with the signal. The robustness of our PLC technology is a compelling attribute of our system and a primary focus of our intellectual property development and engineering resources. In addition, each communication link between a microinverter and the Envoy gateway is encrypted to enhance system security.

Embedded Software

The embedded software that runs in the CPU of our ASIC performs several key functions, including the MPPT algorithm that optimizes energy production from each solar module, the state machine that controls the microinverter's power analysis and power conversion functions, safety functions such as anti-islanding protection, which disables microinverter energy production when the AC grid is disconnected, and the energy information collected from each solar module and microinverter pair. It also actively monitors the operation of the solar PV installation. Finally, it enables the design of more complex functions in software such as sophisticated and intelligent mathematical modeling that reduces the burden on the hardware design.

Web-Based Software

In addition to the embedded software in each Enphase microinverter and Envoy communications gateway, our Enlighten web-based software provides a central point of monitoring and management for the installer and system owner. The system is built on an open source platform and is hosted externally by Rackspace US, Inc., a leading datacenter infrastructure provider. This allows us to minimize our fixed costs and leverage system uptime guarantees from our provider.

The core functionality of our web-based software includes:

- *Monitoring.* The Enphase system provides monitoring granularity down to the individual solar module level. This enables the installer and system owner to determine how much energy each solar module is producing and identify poorly performing modules that need to be washed or replaced, including their specific location in the array.
- *Array Builder and Installer Portal.* In addition to system level monitoring, analytics and diagnostics, the application is an invaluable tool for the installer for everything from system set-up with tools like the array builder to how they manage their entire fleet of systems with the web-based installer portal. An installer is able to visualize the amount of energy generated in a given day or over the life of the system to ensure its proper operation, identify which modules are not producing to specification and aggregate information from multiple systems for a unified, single view into all solar PV installations under management.
- *Home Energy Efficiency Device Control.* Enlighten is a web-based software application for managing solar energy production and controlling energy efficiency devices connected to the Zigbee smart energy profile. Energy efficiency and control represents a potential area of growth for the company as we leverage our communications infrastructure and channel to deliver these additional services.

Our Enlighten web-based software also provides important back-end functionality to Enphase customer service. We use Enlighten to activate a microinverter array, troubleshoot an issue, communicate with the installer, issue and track return merchandise authorizations and analyze energy production trends.

Customers and Sales

Today, our microinverter system is sold exclusively in the United States and Canada, with sales in France, Italy and the Benelux region expected in the second half of 2011. We sell our microinverter systems primarily to distributors who resell to installers and integrators, who in turn integrate our products into complete solar PV installations for residential and commercial system owners.

[Table of Contents](#)

We work with many of the solar distributors, including Focused Energy LLC, SolarNet Holdings, LLC, SunWize Technologies, Inc., and Solar Solutions and Distribution LLC. We have over 2,200 installers, and in 2010 and the first quarter of 2011 that number grew by approximately 100 per month.

Installer Customer Growth (Number of Installers)

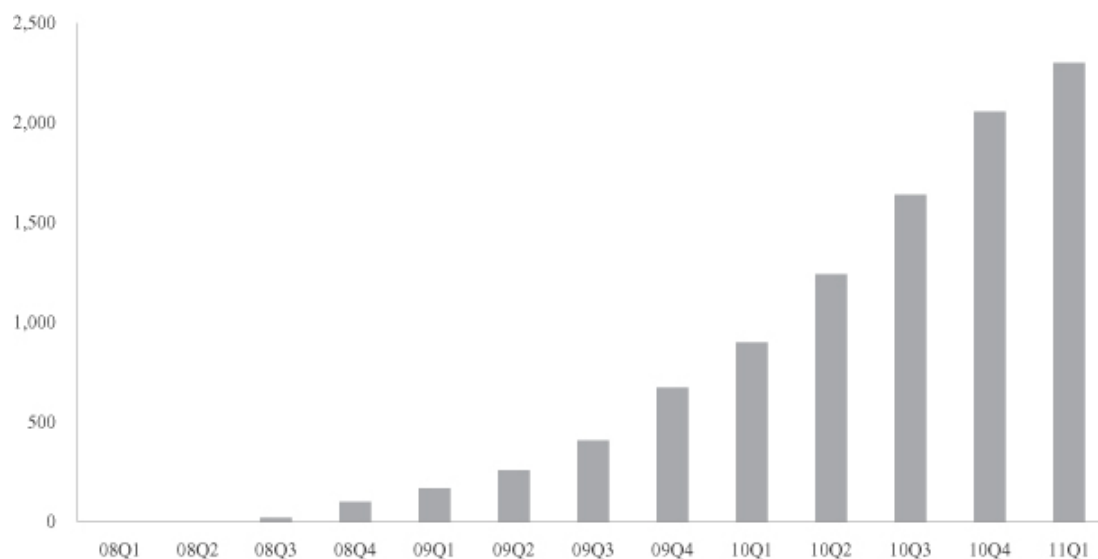

Source: Enphase Energy

In addition to our distributors, we sell directly to large installers, OEMs and strategic partners. Our OEM customers include solar module manufacturers who bundle our products and solutions with their solar module products and resell to both distributors and installers. Strategic partners include a variety of companies and arrangements, including industrial equipment suppliers and providers of solar financing solutions. For example, we have a supply and distribution agreement with Siemens to resell co-branded products and solutions to the electrical contractor distribution channel. We also sell the Enphase-branded product directly to electrical contractor distributors in North America.

To support our geographic expansion plans, we have also established sales and support offices in France and Italy with a go-to-market model similar to the model we use in the United States and Canada. We intend to open an office in China to enhance our support to the Chinese solar module manufacturers with a local on the ground resource, and to establish a sales presence in the country.

Manufacturing and Key Suppliers

We outsource the manufacturing of our products to two key manufacturing partners, Flextronics International Ltd. and Phoenix Contact GmbH & Co. KG. Flextronics assembles and tests our microinverter pursuant to a manufacturing services agreement which is renewable for successive one-year terms and is terminable for convenience by either party upon 90 days prior notice. Prices for such services are mutually agreed to by the parties on a quarterly basis and we are obligated to purchase manufactured products and raw materials that cannot be resold upon the termination of the agreement. Flextronics' assembly and test plants for us are located in Fuyong, China, and New Market, Ontario, Canada. Flextronics also provides receiving, kitting, storage, transportation, inventory visibility and other value-added logistics services at locations managed by

[Table of Contents](#)

Flextronics pursuant to a logistics services agreement which is renewable for successive one-year terms and is terminable for convenience by either party upon 90 days prior notice. Phoenix manufactures the custom AC cable for our third generation M215 microinverter system pursuant to a five-year cooperation agreement extending through December 6, 2015. Phoenix has agreed that the price it charges us will be no greater than those that Phoenix charges other customers for similar products. The agreement further provides for minimum purchase requirements, and we are obligated to purchase manufactured products and raw materials that cannot be resold upon the termination of the agreement. Phoenix's facility is located in Blomberg, Germany.

We rely on several unaffiliated companies to supply certain components used in the fabrication of our microinverter system. For custom components, key sole source suppliers include Fujitsu Ltd. for our ASIC, Epcos AG for magnetic cores and Phoenix for AC cabling. Magnetic cores are purchased on a purchase order basis from Epcos AG. Our five-year master development and production agreement with Fujitsu extends until August 18, 2014 and is terminable for convenience by either party upon six months prior notice. Additional ASIC design projects are negotiated through mutual task orders governed by the master development agreement. For off-the-shelf components, key single source suppliers include Cree, Inc., for diodes and TDK-EPC Corporation for magnetic components.

Customer Service

We maintain high levels of customer engagement through our customer support group and the Enlighten web-based software portal, and have cultivated an organizational focus on customer satisfaction. Our dedicated customer support group, located at our headquarters in Petaluma, California, focuses on responding to inbound inquiries regarding any of our products and services. This support is provided free of charge to all of our customers in the United States and Canada. To support our international expansion into Europe, we have extended the customer support group to include local coverage based in Lyon, France and Milan, Italy. As of May 31, 2011, our Customer Support group consisted of 20 employees in the United States and three employees in Europe.

In addition, customized support programs are being developed for selected OEM partners, large direct installers and master distributors to help prioritize and track support issues for key partners and to provide a single point of contact.

Research and Development

We devote substantial resources to research and development with the objective of developing new products and systems, adding new features to existing products and systems and reducing unit costs of our Enphase microinverter system. Our development strategy is to identify features, products and systems for both software and hardware that reduce the cost and optimize the effectiveness of our microinverter solutions for our customers. We measure the effectiveness of our research and development against metrics, including product unit cost, efficiency, reliability, power output and ease-of-use.

We have a strong research and development team with wide-ranging expertise in power electronics, semiconductors, powerline communications and networking, and software engineering. In addition, many members of our team have expertise in solar technologies. As of May 31, 2011, our research and development organization had a headcount of 102 people, all of whom are in the United States. Our research and development expense in 2008 was \$5.4 million, in 2009 was \$8.4 million, in 2010 was \$14.3 million, and in the three months ended March 31, 2011 was \$5.3 million.

Intellectual Property

Our success depends, in part, on our ability to maintain and protect our proprietary technologies. We rely primarily on patent, trademark, copyright and trade secrets laws in the United States and similar laws in other countries, confidentiality agreements and procedures and other contractual arrangements to protect our technology. As of May 31, 2011, we had nine issued U.S. patents, one issued non-U.S. patent, 45 patent applications pending for examination in the United States and 85 independent patent applications pending for examination in other countries, all of which are related to U.S. applications. Six of our issued U.S. patents directly relate to DC to AC power conversion for alternative energy power systems. The remaining three cover anti-islanding safety technology, measurement of grid voltage and monitoring circuits coupled to AC lines, respectively. Our issued patents will expire between years 2027 and 2030. We also license open source software from third parties for integration into our Envoy products. Such open source software is licensed under open source licenses, including the Beer-Ware License, the GNU General Public License or the GNU Lesser General Public License, Artistic 2.0 License, Ruby License, OpenVPN License, BSD License, Apache License, and other open source licenses. These licenses are perpetual and require us to attribute the source of the software to the original software developer, which we provide via our website.

We continually assess appropriate occasions for seeking patent protection for those aspects of our technology, designs and methodologies and processes that we believe provide significant competitive advantages. A majority of our patents relate to DC to AC power conversion for alternative energy power systems, as well as power system monitoring, control and management systems.

With respect to, among other things, proprietary know-how that is not patentable and processes for which patents are difficult to enforce, we rely on trade secret protection and confidentiality agreements to safeguard our interests. We believe that many elements of our microinverter manufacturing process involve proprietary know-how, technology or data that are not covered by patents or patent applications, including technical processes, test equipment designs, algorithms and procedures.

All of our research and development personnel have entered into confidentiality and proprietary information agreements with us. These agreements address intellectual property protection issues and require our employees to assign to us all of the inventions, designs and technologies they develop during the course of employment with us.

We also require our customers and business partners to enter into confidentiality agreements before we disclose any sensitive aspects of our microinverter, technology or business plans.

We have not been subject to any material intellectual property claims.

Competition

The markets for our products are extremely competitive, and we compete both with well-established traditional central inverter manufacturers and new technology start-ups. The principal areas in which we compete with other companies include:

- Product performance and features;
- Total cost of ownership (usually measured by LCOE);
- Breadth of product line;
- Local sales and distribution capabilities;
- Module compatibility and interoperability;
- Reliability and duration of product warranty;

[Table of Contents](#)

- Technological expertise;
- Brand recognition and customer service and support;
- Compliance with industry standards and certifications and local electrical code;
- Size and financial stability of operations;
- Size of installed base; and
- Local manufacturing and product content.

Currently, competitors in the inverter market range from large, international companies such as Solar Technology AG, Fronius International GmbH and Power-One, Inc. to emerging companies offering alternative microinverter or other solar electronics products. We principally compete with the large, incumbent solar inverter companies because traditional central inverter solutions can be used as alternatives to our microinverter solution. We believe, however, that our microinverter solutions offers greater productivity and competitive differentiation relative to traditional central inverter technology as well as other emerging alternatives to traditional central inverters such as DC to DC optimizers. In addition, we believe that a number of additional public and private companies, including some of our OEM customers and partners, intend to develop competing microinverter solutions. Companies such as SolarBridge Technologies, Inc., Enecsys Limited and INVOLAR Corporation, Ltd have announced or are commercially shipping competing microinverter solutions to markets including North America.

Employees

As of May 31, 2011, we employed 215 full-time employees. Of the full-time employees, 102 were engaged in research and development, 69 in sales and marketing, 30 in a general and administrative capacity and 14 in manufacturing and operations. Of these employees, 201 were in the United States, nine in France, two in Canada, two in Italy and one in New Zealand.

None of our U.S. employees is represented by a labor union with respect to his or her employment with us; however, our employees in France and Italy are represented by a collective bargaining agreement. We have not experienced any employment-related work stoppages, and we consider our relations with our employees to be good.

Legal Proceedings

From time to time, we may be involved in litigation relating to claims arising out of our operations. Currently, we are not involved in any material legal proceedings.

Facilities

Our current corporate headquarters is located in Petaluma, California, in an office consisting of approximately 23,000 square feet of office, testing and product design facilities and a portion of our U.S. customer service center. We have entered into an agreement to lease space for a new corporate headquarters also to be located in Petaluma, California, in an office consisting of approximately 96,000 square feet. Based on current estimates for completion of tenant improvements, we anticipate that tenant improvements will be substantially completed and we will occupy the new headquarters in November 2011. The lease for the new corporate headquarters will expire 10 years from the date tenant improvements are substantially completed. Our current headquarters lease will expire upon the beginning of the term of our new lease.

In addition to our headquarters, we lease approximately 10,500 square feet of warehouse, equipment assembly and general office space in Petaluma, California, on a month-to-month basis, an aggregate of approximately 13,000 square feet of office space in an additional building in Petaluma, California, under a lease that expires in November 2011, and 14,000 square feet of general office space in Boise, Idaho, that will be used

[Table of Contents](#)

for our tier-1 customer call center operations, pursuant to a lease that will expire 65 months from the date tenant improvements are substantially completed. Based on current estimates for completion of tenant improvements, we anticipate that tenant improvements will be substantially completed and we will occupy the Boise facility in July 2011. We also have a small amount of sales and support office space in Lyon, France, Milan, Italy and Shanghai, China.

We outsource the manufacturing to manufacturing partners, and currently do not own or lease or plan to own or lease manufacturing facilities.

We believe that our existing properties are in good condition and are sufficient and suitable for the conduct of our business for the foreseeable future. To the extent our needs change as our business grows, we believe that additional space and facilities will be available.

MANAGEMENT

Executive Officers and Directors

The following table sets forth the names, ages and positions of our executive officers and directors as of June 30, 2011:

<u>Name</u>	<u>Age</u>	<u>Position(s)</u>
<i>Executive Officers</i>		
Paul B. Nahi	48	President, Chief Executive Officer, and Director
Sanjeev Kumar	47	Chief Financial Officer
Raghuvveer R. Belur	44	Vice President of Products, and Director
Martin Fornage	48	Chief Technology Officer
Jeff Loebbaka	49	Vice President of Worldwide Sales
Greg Steele	50	Vice President of Operations
Bill Rossi	48	Chief Marketing Officer
Dennis Hollenbeck	59	Vice President of Engineering
<i>Directors</i>		
Neal Dempsey ⁽¹⁾⁽²⁾⁽³⁾	70	Director
Steven J. Gomo ⁽²⁾⁽³⁾	59	Director
Benjamin Kortlang ⁽¹⁾⁽²⁾	36	Director
Jameson J. McJunkin ⁽¹⁾	36	Director
Chong Sup Park ⁽²⁾⁽³⁾	63	Director
Robert Schwartz ⁽³⁾	49	Director
Stoddard M. Wilson ⁽³⁾	45	Director

(1) Member of the Nominating and Corporate Governance Committee.

(2) Member of the Audit Committee.

(3) Member of the Compensation Committee.

Our executive officers are appointed by, and serve at the discretion of, our board of directors. There are no familial relationships among our directors and executive officers. Set forth below is biographical information, including the experiences, qualifications, attributes or skills that caused our board of directors to determine that each member of our board of directors should serve as a director as of the date of this prospectus.

Executive Officers

Paul B. Nahi has served as our President and Chief Executive Officer and as a member of our board of directors since January 2007. From 2003 to December 2006, Mr. Nahi served as President and Chief Executive Officer of Crimson Microsystems, Inc., a fabless semiconductor company, where he was responsible for all aspects of the company's operations. From 1999 to 2003, Mr. Nahi served as Chief Executive Officer and co-founder of Accelerant Networks, Inc., a semiconductor company, acquired by Synopsys Inc. in February 2004. From 1998 to 1999, Mr. Nahi served as the General Manager of the Communications and Media Divisions for NEC Electronics Corp., a global electronics company. From 1994 to 1998, Mr. Nahi served as the Senior Director for Diamond Multimedia Systems, Inc., a computer peripheral device company. Mr. Nahi holds a bachelor of science degree in computer science and a master of business administration degree from the University of Southern California. Mr. Nahi brings to our board of directors demonstrated leadership and management ability at senior levels. In addition, his years of experience in the semiconductor and electronics industries provide a valuable perspective for our board. He also brings continuity to our board and historical knowledge of our company through his tenure as President and Chief Executive Officer.

Sanjeev Kumar has served as our Chief Financial Officer since December 2009. From December 2008 to July 2009, Mr. Kumar served as the Chief Financial Officer of HelioVolt Corporation, a producer of thin film solar products, where he was responsible for financial and accounting functions. From June 2006 to August 2008,

[Table of Contents](#)

Mr. Kumar served as the Chief Financial Officer of Energy Conversion Devices, Inc., a supplier of thin-film flexible solar laminates and batteries used in hybrid vehicles, where he was responsible for financial and accounting functions. Prior to 2006, Mr. Kumar served in a number of different finance positions, most recently as the Chief Financial Officer of Rutherford Chemicals LLC, a specialty chemical company, as Chief Financial Officer of the U.S. operations of Rhodia S.A., a publicly held chemicals company, and as Assistant Treasurer, with Occidental Petroleum Corporation, an oil and gas exploration and production company. Mr. Kumar previously served on the Board of Directors of Solar Integrated Technologies Inc., a publicly-listed company in the United Kingdom and Ovonyx, Inc., a privately-held company commercializing its phase-change semiconductor memory technology. Mr. Kumar holds a bachelor of arts degree in business administration from California State University, Los Angeles and a master of business administration degree from the University of Southern California.

Raghuv eer R. Belur co-founded Enphase Energy with Mr. Fornage in March 2006, and has served as a member of our board of directors since March 2006. Mr. Belur has served as our Vice President of Product since September of 2010 and previously as Vice President of Marketing from January 2007 to September of 2010. Mr. Belur was our initial Chief Executive Officer from March 2006 to January 2007. From September 1997 to August 1999, Mr. Belur served as an Engineer for Cerent Corporation, an optical equipment company acquired by Cisco Systems, Inc., in August 1999. Mr. Belur holds a master of science degree in electrical engineering from Texas A&M University and a master of business administration degree from the Haas School of Business at the University of California, Berkeley. As a co-founder of our company and through his position as Vice President of Products, Mr. Belur brings to our board of directors continuity and historic knowledge of our company. In addition, his years of marketing and engineering experience in the electronics industry provide valuable insights for our board.

Martin Fornage co-founded Enphase Energy with Mr. Belur in March 2006, and has served as our Chief Technology Officer since July 2006. From December 1992 to July 1998, Mr. Fornage was a Hardware Engineer at Advanced Fibre Communications, Inc., a telecommunications company acquired by Tellabs, Inc., in May 2004, where he led the Hardware Engineering group in 1997. From September 1998 to February 2006, Mr. Fornage led a consulting firm providing system and assembly level design services to several large telecommunications equipment manufacturers and other companies. Mr. Fornage received his "Ingenieur diplome d'etat" degree from ENSEA France.

Jeff Loebbaka has served as our Vice President of Worldwide Sales since May 2010. From July 2007 to June 2009, Mr. Loebbaka was Senior Vice President of Europe, Middle East and Africa, from July 2005 until June 2007, was Senior Vice President of Global Channel Sales and Marketing, and from October 2003 to June 2005, was Vice President Global Marketing at Seagate Technology LLC, a storage solutions provider. In these positions, he was responsible for sales functions within the geographic or business areas covered by his titles. From September 2000 to September 2003, Mr. Loebbaka served as Vice President and General Manager, and from June 1999 until August 2000, served as Vice President of Worldwide Channels and Corporate Marketing at Adaptec Inc., a RAID controller maker and data center company. From May 1996 to November 1998, Mr. Loebbaka was Vice President of Global Marketing at the Life Fitness Division of Brunswick Corporation, and from January 1995 until May 1996, was the Senior Director of Product Marketing at Zenith Data Systems, a division of Group Bull. Mr. Loebbaka held numerous marketing leadership roles at Apple Inc. from July 1987 until January 1995. Mr. Loebbaka holds a master of business administration degree from the Kellogg Graduate School of Management at Northwestern University and a bachelor of science in mechanical engineering from the University of Illinois.

Greg Steele has served as our Vice President of Operations since January 2008. From March 2006 to December 2007, Mr. Steele founded and served as the President of Wireless Hearing Solutions, an assistive listening device company, where he was responsible for all aspects of the company's operations. From January 2003 to May 2005, Mr. Steele served as the Chief Executive Officer for the Nelson Family of Companies, a human capital and staffing firm. From December 1998 to June 2001, Mr. Steele served as Chief Operating

[Table of Contents](#)

Officer, and from November 1994 to December 1998, served as Vice President of Operations for Advanced Fibre Communications, Inc., a telecommunications company acquired by Tellabs, Inc. in May 2004. From April 1984 to October 1990, Mr. Steele held various manufacturing and operations positions with Texas Instruments Inc., a global electronics company. From October 1990 to November 1994, Mr. Steele held various manufacturing and operations positions with DSC Communications Corporation, a telecommunications company. Greg Steele holds a bachelor of science degree in industrial engineering from Oregon State University.

Bill Rossi has served as our Chief Marketing Officer since September 2010. From December 2007 to July 2010, Mr. Rossi was head of Enterprise Marketing at Google Inc., an Internet search and services company, where he was responsible for marketing of Google applications to businesses. From December 2005 to December 2006, Mr. Rossi was Chief Executive Officer of Greenfield Networks Inc., an ethernet switch technology solutions company acquired by Cisco Systems, Inc., in December 2006, where he was responsible for all aspects of the company's operations. From November 1995 to November 2005, Mr. Rossi served as Vice President and General Manager of the Wireless Networking Business Unit at Cisco Systems, Inc. Mr. Rossi holds a master of business administration degree from Harvard Business School and a bachelor of arts and bachelor of science degree in electrical engineering from Dartmouth College.

Dennis Hollenbeck has served as our Vice President of Engineering since December 2010. From June 2005 to July 2006 Mr. Hollenbeck served as Vice President and General Manager for Maxtor Corp., a hard disc drive manufacturer, where he was responsible for engineering and operations. From June 2000 to September 2005, Mr. Hollenbeck served as Chief Operating Officer for eSilicon Corp., a custom chip design and fabrication service company. From July 1984 to June 2000, Mr. Hollenbeck held various positions with Quantum Corporation, a hard disc drive manufacturer. Mr. Hollenbeck holds a bachelor of engineering, electrical engineering from Youngstown State University.

Board of Directors

Neal Dempsey has served as a member of our board of directors since April 2010. Mr. Dempsey joined Bay Partners as a General Partner in 1989 and became a Managing Member in 2000. From December 1996 to April 2007, Mr. Dempsey served as a member of the board of directors of Brocade Communications Systems, Inc. Mr. Dempsey is presently a director of several privately-held companies and also serves as a director of FamiliesFirst, Inc., a Children and Family Services Agency. Mr. Dempsey holds a bachelor of arts degree from the University of Washington. As a venture capitalist, Mr. Dempsey has been involved with numerous technology companies in the communications, consumer services, energy services, enterprise software, software as a service, and wireless industries. Mr. Dempsey's years of venture capital investing, his previous experience as a public company director and his insights in building successful businesses provide a valuable perspective to the board of directors.

Steven J. Gomo has served as a member of our board of directors since March 2011. Since August 2002, Mr. Gomo has served as Senior Vice President of Finance and Chief Financial Officer, and since October 2004, as Executive Vice President of Finance and Chief Financial Officer of NetApp, Inc., a computer storage and data management company. From November 2000 to April 2002, Mr. Gomo served as Chief Financial Officer of Gemplus International S.A., a smart card provider, and from February 1998 until August 2000, Mr. Gomo served as Chief Financial Officer of Silicon Graphics, Inc., a high-performance computer and computer graphics company. Prior to February 1998, Mr. Gomo held various finance, financial management, manufacturing, and general management positions at Hewlett-Packard Company. Mr. Gomo holds a master of business administration degree from Santa Clara University and a bachelor of science degree in business administration from Oregon State University. Mr. Gomo currently serves on the board of SanDisk Corporation. Mr. Gomo brings to our board valuable financial and business expertise through his years of experience as a chief financial officer with publicly traded companies. Mr. Gomo provides an important role in leading the board's activities on financial and auditing matters, as well as collaborating with our independent registered public accounting firm and management team in these areas.

[Table of Contents](#)

Benjamin Kortlang has served as a member of our board of directors since May 2010. Since February 2008, Mr. Kortlang has been a Partner with Kleiner Perkins Caufield & Byers, a venture capital firm. From July 2000 to January 2008, Mr. Kortlang worked with Goldman, Sachs & Co., most recently co-heading Goldman's Alternative Energy Investing business. From June 2005 to February 2008, Mr. Kortlang was a Vice President within Goldman's Special Situations Group, before which he was a Vice President in Goldman's investment banking group focusing on Industrials and Natural Resources. From January 1996 to August 1998, Mr. Kortlang was an Associate with A.T. Kearney, Inc. where he focused on strategic and operations consulting in the energy, manufacturing, packaging, transportation and communications industries. From February 1993 to July 1994, Mr. Kortlang was a Business Analyst at National Australia Bank in strategic planning and macroeconomic forecasting. Mr. Kortlang holds a bachelor of business degree in economics and finance from Royal Melbourne Institute of Technology, a bachelor of commerce and an honors degree in econometrics from University of Melbourne and a master of business administration degree from the University of Michigan. As a venture capitalist, Mr. Kortlang's focus on growth-stage investing in alternative energy technologies provides a valuable industry perspective to our board. Mr. Kortlang's investing and business experience also provide our board with a valuable perspective on building alternative energy businesses.

Jameson J. McJunkin has served as a member of our board of directors since April 2009. Since April 2005, Mr. McJunkin has been a Managing Member of Madrone Capital Partners, a venture capital firm. From August 2000 to March 2005, Mr. McJunkin was a technology growth capital investor at TA Associates, Inc., a private equity firm. Prior to August 2000, Mr. McJunkin worked as a Product Manager at Cisco Systems, Inc. and as a strategy consultant at the Boston Consulting Group. Mr. McJunkin is a director of the Smithsonian National Air and Space Museum and several privately-held companies. He also serves on the Advisory Board for Rockport Capital Partners and The Global Environment Fund. Mr. McJunkin earned a bachelor of arts degree with high honors from the Woodrow Wilson School of Public and International Affairs at Princeton University and a master of business administration degree from the Stanford University Graduate School of Business. Mr. McJunkin has valuable experience as an investor in building emerging growth companies. His investing and business background, as well as his knowledge of the solar industry, provide a valuable perspective for our board of directors.

Dr. Chong Sup Park has served as a member of our board of directors since June 2011. Dr. Park served as President and Chief Executive Officer of Maxtor Corporation, a hard drive manufacturer, from February 1995 to August 1996, and from November 2004 to May 2006, prior to its acquisition by Seagate Technology LLC. Dr. Park served as Maxtor's director from February 1994 and its Chairman of the Board from May 1998 to May 2006. Dr. Park served as Investment Partner and Senior Advisor at H&Q Asia Pacific, a private equity firm, from April 2004 until September 2004, and as Managing Director of the firm from November 2002 to March 2004. Prior to joining H&Q, Dr. Park served as President and Chief Executive Officer of Hynix Semiconductor Inc., a DRAM and FLASH memory manufacturer, from March 2000 until May 2002, and from June 2000 to May 2002 he also served as its Chairman. Dr. Park currently serves as a member of the board of directors of Ballard Power Systems, Inc., Brooks Automation, Inc., Computer Sciences Corporation, and Seagate Technology. Within the past five years, Dr. Park also served as a member of the board of directors of STATS ChipPAC Ltd. and Smart Modular Technologies, Inc. Dr. Park earned his a bachelor of arts degree from Yonsei University, Seoul, a master of business administration degree from the University of Chicago, and a doctorate degree in business administration from Nova Southeastern University. Dr. Park brings to our board of directors valuable experience in leadership, technology, manufacturing, sales and marketing as a former board chair and Chief Executive Officer of global businesses in the storage, semiconductor and electronics industry. Dr. Park with his international background also adds business and cultural diversity to our board of directors' perspective.

Robert Schwartz has served as a member of our board of directors since February 2007. Since June 2000, Mr. Schwartz has been Managing Partner of Third Point Ventures, the Sunnyvale, California-based venture capital arm of Third Point LLC, which is a registered investment adviser based in New York and the investment manager of the Third Point Funds. Since 1984, Mr. Schwartz has also been the President of RF Associates North, Inc., a privately-held technical manufacturer's representative firm. Mr. Schwartz is presently a director of several

[Table of Contents](#)

privately-held companies. Mr. Schwartz holds an undergraduate engineering degree from the University of California, Berkeley. Mr. Schwartz's background as an executive of a technical manufacturer's representative firm provides our board and management with important insights on supply chains and sales channels. In addition, his experience as a venture capital investor and his long-standing experience on our board enables him to provide key insight, historical knowledge and guidance to our management team and board of directors.

Stoddard M. Wilson has served as a member of our board of directors since April 2008. In February 1998, Mr. Wilson joined RockPort Partners as a General Partner, a merchant bank specializing in the energy and environmental sectors, and helped form their venture fund in 2001. From August 1996 to January 1998, Mr. Wilson served as a general manager of Montague Corporation, a manufacturing company. From July 1990 to June 1994, Mr. Wilson served as Director of External Affairs and held positions in Admissions, Development and Financial Assistance with Wilbraham & Monson Academy, a private secondary school. From June 1987 to May 1990, Mr. Wilson held technical, sales and marketing positions with AT&T Inc. Mr. Wilson is presently a director of several privately-held companies. Mr. Wilson holds two bachelor of arts degrees, in history and economics, from Brown University and a master of business administration degree from Harvard Business School. As a venture capitalist, Mr. Wilson's focus on energy and environmental technologies, as well as his experience in building and managing startup businesses, provides a valuable perspective to our board.

Director Independence

Upon the completion of this offering, our common stock is expected to be listed on the NASDAQ Global Market. Under the rules of the NASDAQ Stock Market, LLC, or NASDAQ, "independent" directors must make up a majority of a listed company's board of directors within a specified period following that company's listing date in conjunction with its initial public offering. In addition, applicable NASDAQ rules require that, subject to specified exceptions, each member of a listed company's audit, compensation and nominating committees be independent within the meaning of applicable NASDAQ rules. Audit committee members must also satisfy the independence criteria set forth in Rule 10A-3 under the Securities Exchange Act of 1934, as amended, or the Exchange Act.

In June 2011, our board of directors undertook a review of the independence of each director and considered whether any director has a material relationship with us that could compromise his ability to exercise independent judgment in carrying out his responsibilities. As a result of this review, our board of directors determined that all of our directors, other than Messrs. Nahi and Belur, qualify as "independent" directors within the meaning of the NASDAQ rules. Accordingly, a majority of our directors are independent, as required under applicable NASDAQ rules. As required under applicable NASDAQ rules, we anticipate that our independent directors will meet in regularly scheduled executive sessions at which only independent directors are present.

Board Composition

Our board of directors is currently composed of nine members. Our certificate of incorporation and our bylaws permit our board of directors to establish by resolution the authorized number of directors, and nine directors are currently authorized. Our directors hold office until their successors have been elected and qualified, or the earlier of their death, resignation or removal.

Following the completion of this offering, at each annual meeting of stockholders, a class of directors will be elected for a three-year term to succeed the class whose term is then expiring. The terms of the directors will expire upon the election and qualification of successor directors at the annual meeting of stockholders to be held during 2012 for the Class I directors, 2013 for the Class II directors and 2014 for the Class III directors. We intend to designate particular directors into each of these classes prior to the completion of this offering.

The division of our board of directors into three classes with staggered three-year terms may delay or prevent a change of our management or a change in control. Under Delaware law, our directors may be removed for cause by the affirmative vote of the holders of a majority of our voting stock.

Board Committees

Our board of directors has an audit committee, a compensation committee and a nominating and corporate governance committee, each of which has the composition and responsibilities described below.

Audit Committee. Our audit committee oversees our corporate accounting and financial reporting processes. For that purpose, our audit committee, among other things:

- evaluates the qualifications and performance of our independent registered public accounting firm;
- determines and approves the scope of engagement and compensation of our independent registered public accounting firm;
- confers with management and our independent registered public accounting firm regarding the effectiveness of our internal control over financial reporting; and
- establishes procedures for the receipt, retention and treatment of complaints regarding accounting, internal accounting controls or auditing matters.

Our audit committee also has certain responsibilities, including without limitation, the following:

- selecting and hiring the independent registered public accounting firm;
- evaluating the independent registered public accounting firm;
- approving audit and non-audit services and fees; reviewing and discussing with management and the independent registered public accounting firm our annual audited and quarterly financial statements, the results of the independent audit and the quarterly reviews, and the reports and certifications regarding internal control over financial reporting and disclosure controls; and
- reviewing reports and communications from the independent registered public accounting firm.

The members of our audit committee are Messrs. Dempsey, Gomo, Park, and Kortlang. Our board of directors has determined that Mr. Gomo is an “audit committee financial expert” as defined under applicable SEC rules. Mr. Gomo has been appointed to serve as the chairman of our audit committee. Each member of our audit committee meets the requirements for independence for audit committee service under the current requirements of the NASDAQ Global Market and Rule 10A-3 under the Exchange Act.

Compensation Committee. Our compensation committee oversees our corporate compensation policies, plans and benefits programs. The functions of the committee include:

- reviewing and approving the compensation and other terms of employment of our executive officers and senior members of management and reviewing and approving corporate performance goals and objectives relevant to such compensation; and
- administering our stock option plans, stock purchase plans, compensation plans and similar programs, including the adoption, amendment and termination of such plans.

The members of our compensation committee are Messrs. Dempsey, Gomo, Park, Schwartz, and Wilson. Dr. Park has been appointed to serve as the chairman of our compensation committee effective upon the completion of this offering. We believe that each member of our compensation committee meets the requirements for independence under the current requirements of the NASDAQ Global Market, is a non-employee director as defined by Rule 16b-3 promulgated under the Exchange Act, and is an outside director as defined pursuant to Section 162(m) of the Code.

Nominating and Corporate Governance Committee. Our nominating and corporate governance committee consists of Messrs. Dempsey, Kortlang and McJunkin, each of whom is a non-employee member of our board of directors. Mr. Dempsey is the chairman of our nominating and corporate governance committee. Our board of

[Table of Contents](#)

directors has determined that each of the directors serving on our nominating and corporate governance committee is independent within the meaning of the listing standards of the NASDAQ Global Market. The functions of this committee include:

- assessing the performance of our management and our board of directors;
- identifying, reviewing, and evaluating candidates to serve on our board of directors, including nominations by stockholders of candidates for election to our board of directors;
- reviewing and evaluating incumbent directors;
- making recommendations to our board of directors regarding the membership of the committees of the board of directors; and
- developing a set of corporate governance principles.

Compensation Committee Interlocks and Insider Participation

Our compensation committee currently consists of Messrs. Dempsey, Gomo, Park, Schwartz, and Wilson. None of the members of our compensation committee has, at any time, been one of our officers or employees. None of our executive officers serves, or in the past year has served, as a member of the board of directors or compensation committee of any entity that has one or more executive officers serving on our board of directors or compensation committee. For more information, see “Certain Relationships and Related Party Transactions” appearing elsewhere in this prospectus.

Code of Business Conduct and Ethics

Prior to the completion of this offering, our board of directors intends to adopt a code of business conduct and ethics that applies to all of our employees, officers and directors, including those officers responsible for financial reporting. Upon the completion of this offering, the code of business conduct and ethics will be available on our website at www.enphase.com. We intend to disclose future amendments to the code, or any waivers of its requirements on our website to the extent permitted by the applicable rules and exchange requirements. The inclusion of our website address in this prospectus does not include or incorporate by reference the information on our website into this prospectus.

Non-Employee Director Compensation

During 2010, our non-employee directors did not receive any cash compensation, stock awards or other compensation for their services as members of our board of directors or any committee of our board of directors. As of December 31, 2010, none of our non-employee directors held any outstanding stock options or stock awards. Upon appointment of Mr. Gomo to our board in March 2011, he received a stock option to purchase 300,000 shares of common stock with an exercise price of \$0.45 per share. This option grant vests as to 6,250 shares per month, beginning from April 10, 2011. Upon appointment of Dr. Park to our board in June 2011, he received a stock option to purchase 300,000 shares of common stock with an exercise price per share to be equal to the fair market value of our common stock as of June 30, 2011, as will be determined by our compensation committee after receiving an updated independent valuation report. This option grant vests as to 6,250 shares per month, beginning from June 23, 2011.

[Table of Contents](#)

New Director Compensation Program

Effective upon completion of this offering our non-employee directors will receive the following cash compensation:

Annual retainer board member	\$35,000
Additional retainer audit committee chair ⁽¹⁾	18,000
Additional retainer audit committee member ⁽²⁾	8,000
Additional retainer compensation committee chair ⁽¹⁾	12,000
Additional retainer compensation committee member ⁽²⁾	6,000
Additional retainer nominating and governance committee chair ⁽¹⁾	8,000
Additional retainer nominating and governance committee member ⁽²⁾	3,000

(1) Assumes five committee meetings per year, after which a \$1,500 per meeting fee will apply.

(2) Assumes five committee meetings per year, after which a \$1,000 per meeting fee will apply.

In addition, each board member will receive an initial option grant with a target value of \$120,000, with 25% of the shares vested on the grant date and 25% vesting on each annual anniversary thereafter, and an annual option grant with a target value of \$75,000 vesting after one year, in each case using a Black-Scholes option value model and with an exercise price per share equal to the fair market value on the date of grant.

We also intend to seek to recruit and/or appoint either a non-employee chairman of our board of directors or a lead independent director. We expect that an annual cash retainer will be established for this position, and the chairman or lead independent director will be eligible to receive stock option grants in light of his or her role and responsibilities. We expect that the overall compensation for this position will reflect the value brought by the specific individual appointed to this position, based on the responsibility and time commitments associated with this role, as well as market conditions at the relevant time.

COMPENSATION DISCUSSION AND ANALYSIS

The following discussion provides an overview of our executive compensation philosophy, the overall objectives of our executive compensation program, and each compensation component that we provide. In addition, we explain how and why we arrived at specific compensation policies and decisions involving our executive officers, including Messrs. Nahi, Kumar, Fornage, Loebbaka and Belur, who are referred to as our named executive officers and are listed in the “Summary Compensation Table” set forth under “Executive Compensation,” during 2010.

This Compensation Discussion and Analysis contains forward-looking statements that are based on our current plans, considerations, expectations, and determinations regarding future compensation programs. The actual compensation programs that we adopt may differ materially from currently planned programs that are summarized in this discussion.

Executive Compensation Philosophy and Objectives

We compete with many other companies in seeking to attract and retain a skilled management team. To meet this challenge, we have employed a compensation philosophy of offering our executive officers competitive compensation and benefits packages that focus on long-term value creation and rewarding the management team members for achieving our financial and strategic objectives.

We have oriented our executive compensation program to accomplish the following objectives:

- provide total compensation opportunities, which enable us to recruit and retain executives with the experience and skills to manage the growth of our company and lead us to the next stage of development;
- create a direct and meaningful link between company business results, individual performance, and rewards;
- establish a clear alignment between the interests of our executives and the interests of our stockholders;
- reinforce a culture of ownership, excellence, and urgency; and
- offer total compensation that we believe is competitive and fair.

Compensation Program Design

To date, the compensation of our executive officers, including our named executive officers, has consisted of base salaries, cash bonuses, equity compensation in the form of stock options and restricted stock awards, employee benefits, relocation packages and certain post-employment arrangements.

The key component of our executive compensation program has been equity awards for shares of our common stock. As a privately-held company prior to this offering, we have emphasized the use of equity to provide incentives for our executive officers to focus on the growth of our overall enterprise value and, correspondingly, to create value for our stockholders. We have used stock options as our primary equity award vehicle. We believe that stock options offer our employees, including our named executive officers, a valuable long-term incentive that aligns their interests with the long-term interests of our stockholders.

We also offer cash compensation in the form of base salaries and cash bonuses that we believe, overall, are competitive within the market range for companies of similar size, stage of development, and growth potential.

We have not adopted policies or guidelines for allocating compensation between current and long-term compensation, between cash and non-cash compensation, or among different forms of non-cash compensation. Instead, we review each component of executive compensation separately and also take into consideration the value of each executive’s compensation package as a whole, both based on its value and its relative size in comparison to the other members of the executive team.

Compensation-Setting Process

To obtain the skills and experience that we believe are necessary to lead our growth, most of our executive officers were hired from larger organizations and have significant experience in their roles. Their initial compensation arrangements have been determined in individual negotiations with each executive in connection with his joining us, taking into account his qualifications, experience, and prior compensation levels. Historically, the compensation committee of our board of directors would develop the offer for the candidate with the assistance of our Chief Executive Officer. Our Chief Executive Officer and our compensation committee would also seek input and approval from our board of directors when necessary or advisable, and the board would approve overall executive compensation with recommendations from the compensation committee.

More recently, since July 2010, our compensation committee has been responsible for overseeing our executive compensation program, as well as determining and approving the ongoing compensation arrangements for our Chief Executive Officer and our other executive officers, including our named executive officers. Typically, our Chief Executive Officer makes recommendations to our compensation committee regarding compensation matters, except with respect to his own compensation, and will often attend the compensation committee meetings, while excusing himself from any discussions involving his own compensation. The recommended compensation of our Chief Executive Officer is proposed by our compensation committee. Once finalized, typically recommendations for executive compensation are presented by our compensation committee to our board of directors for its approval, though our compensation committee has the authority to approve the compensation of the executive officers within guidelines pre-determined by our board of directors. In July 2010, our board of directors approved a compensation committee charter that delegates to our compensation committee the authority to establish and review the compensation of our executive officers, including our named executive officers.

Our compensation committee is authorized to retain the services of executive compensation advisors from time to time, as it sees fit, in connection with the establishment of cash and equity compensation plans and arrangements and related policies. In August 2010, our compensation committee engaged Compensia, Inc., a national compensation consulting firm providing executive compensation advisory services, to assist it in evaluating our executive compensation philosophy, to provide market data on executive compensation practices and to provide guidance on administering our executive, employee and equity compensation programs. Compensia serves at the discretion of our compensation committee.

Use of Competitive Data

Beginning in 2011, to assess the competitiveness of our executive compensation program and current compensation levels and to assist it in setting compensation levels, our compensation committee refers to compensation data compiled with respect to the compensation of executives in comparable positions at a group of comparable companies, which we refer to as the peer group. The companies comprising the peer group have been selected on the basis of their similarity to our Company in size (as determined by revenue and market capitalization) and product or service similarity. Compensation data for the companies comprising the peer group is gathered from public filings and from Compensia's proprietary compensation databases.

[Table of Contents](#)

For 2011, based on consultations with Compensia, our compensation committee approved the following companies as our peer group for purposes of determining compensation:

A123 Systems, Inc.	Digi International Inc.	Maxwell Technologies, Inc.
Acme Packet, Inc.	Echelon Corporation	Nanometrics Incorporated
Advanced Energy Industries, Inc.	EMCORE Corporation	Powersecure International, Inc.
Aruba Networks, Inc.	Energy Conversion Devices, Inc.	SatCon Technology Corporation
CalAmp Corp.	EnerNOC, Inc.	Sonus Networks, Inc.
Codexis, Inc.	Fortinet, Inc.	Vicor Corporation
Comverge, Inc.	Isilon Systems, a division of EMC Corporation	

Our compensation committee intends to review the composition of the peer group periodically and make adjustments to its composition as necessary.

In addition to the peer group, beginning in 2011 our compensation committee reviewed survey data from the Radford Global Technology Survey to supplement its understanding of the market for executive compensation.

While our compensation committee reviews the compensation data for, and compensation practices from, the peer group to inform its decision-making process, it does not set compensation components to meet specific benchmarks. Our compensation committee uses peer-group data as a point of reference so that it can set total compensation levels that it believes are reasonably competitive, but also believes that over-reliance on benchmarking can result in compensation that is unrelated to the value delivered by our executives. While compensation levels may differ among executives on competitive factors, and the role, responsibilities and performance of each specific executive, there are no material differences in the compensation philosophies, objectives or policies for our executives, including our named executive officers.

Executive Compensation Program Components

The following describes each component of our executive compensation program, the rationale for each, and how awards are determined.

Base Salary

In 2010, as a private company, our philosophy with respect to base salaries was to maintain minimal differentiation between the members of our executive team, with only Mr. Nahi, our Chief Executive Officer, paid somewhat more than the other executive officers and Mr. Belur paid somewhat less than the other executive officers due to his higher stock ownership arising from being a co-founder of our company. Generally, when adjusting the base salaries of our executive officers, we take into consideration our company's performance during the last completed fiscal year, our Chief Executive Officer's recommendations, the evaluation of the expected and actual performance of each executive officer, his individual contributions and responsibilities, and the relative base salaries of the other executive officers.

In 2010, we adjusted the base salaries of our named executive officers as follows:

- In May 2010, we increased the base salary of Mr. Nahi by \$20,000 (retroactive to January 2010) to reward Mr. Nahi for his significant contributions to the company and to reflect his critical importance to the company.
- In January 2010, we increased the base salary of Mr. Fornage, our Chief Technology Officer and a co-founder of our company, by \$65,000 to reflect his leadership during 2009 with respect to the development of our solar energy generation solution, to reflect his continuing key role in the enhancement of our products during a critical year in our company's growth, and to recognize our Chief Executive Officer's evaluation of his performance during 2009. This increase was also intended

[Table of Contents](#)

to offset the lower pay scale to which Mr. Fornage, as a co-founder and an original employee of our company, had been subject as we sought to bring his base salary in line with those of our other executive officers.

- In January 2010, we increased the base salary of Mr. Belur, our Vice President of Products, by \$10,000 to reward Mr. Belur for his significant contributions to the company, to reflect his importance to the company and to increase pay parity among our executive officers.
- Messrs. Kumar and Loebbaka did not receive a base salary adjustment due to their recent hiring.

The base salaries paid to our named executive officers during 2010 are set forth in the “Summary Compensation Table” under “Executive Compensation.”

In February 2011, we adjusted the base salaries of our named executive officers (retroactive to January 2011) as follows:

- We increased the base salary of Mr. Nahi by \$60,000 to reflect his successful execution of our business strategy during 2010, his success in positioning our company, consistent with this strategy, for a potential initial public offering of our equity securities, and the competitive market for chief executive officers of technology and alternative energy companies, as reflected in the market survey data and our peer group.
- We increased the base salary of Mr. Fornage by \$25,000 to reflect his leadership during 2010 with respect to the development of our solar energy generation solution, thereby positioning our company for a potential initial public offering of our equity securities, and the competitive market for chief technology officers of technology and alternative energy companies, as reflected in the market survey data and our peer group.
- We increased the base salary of Mr. Loebbaka, our Vice President of Worldwide Sales, by \$10,000 to reflect the competitive market for sales executives of technology and alternative energy companies, as reflected in the market survey data and our peer group.
- Messrs. Belur and Kumar did not receive a base salary adjustment in 2011 because it was determined that their salaries were competitive against the market.

Cash Bonuses

We use cash bonuses to motivate our executive officers to achieve our annual financial and strategic objectives. In some cases, the initial cash bonus opportunities of our executive officers were established through arm’s-length negotiation at the time of hiring. Aside from pre-agreed upon bonus opportunities, bonus opportunities generally have been provided on a discretionary basis by our compensation committee. Our sales executives, including our Vice President of Worldwide Sales, participate in our sales commission plan instead of being eligible to receive a cash bonus.

In 2011, we awarded the 2010 cash bonuses to our named executive officers, except our Vice President of Worldwide Sales, based upon the judgment of our Chief Executive Officer and, with respect to our Chief Executive Officer, our compensation committee and taking into account our performance, the performance of each named executive officer, his overall cash compensation and his equity holdings. The terms of the bonus for each executive varied, with preset goals for our Chief Executive Officer and a discretionary approach for our other named executive officers.

For our Chief Executive Officer, our board of directors determined in March 2010 to pay a bonus of up to \$50,000 and set five performance goals, each worth \$10,000, to be achieved to receive this bonus. These goals were: target revenue of \$84 million (this goal also required our ability to have our projects funded by at least two-tier one financial institutions), achieving a fourth quarter non-GAAP gross margin goal of 23%, achieving

[Table of Contents](#)

financial readiness for an initial public offering by October 31, having a certified product ready for sale in Europe by the end of 2010, and signing two OEM supply agreements with key solar companies. The Compensation Committee determined that the first two goals were partially met for a payment of \$5,000 each, with the remaining goals not met. However, the committee believed that due to the rapid growth of our company over 2010 and continuing evolution of the key metrics for our success, the goals did not adequately reflect the highest priorities for the company by the end of 2010. In light of our strong overall performance in 2010, and acknowledging Mr. Nahi's exceptional personal contributions, the Committee approved a special discretionary bonus of \$30,000 (in addition to the \$10,000 awarded for partial achievement of pre-established goals). Our Vice President of Worldwide Sales was eligible to receive a sales commission of up to \$145,000 pursuant to his negotiated employment offer letter upon the achievement of certain revenue based sales performance targets, weighted at 75% of his aggregate sales commission, and certain non-revenue based key sales objectives, weighted at 25% of his aggregate sales commission. Of the \$145,000 maximum amount, Mr. Loebbaka earned \$133,325 for exceeding his revenue based sales targets and for his achievement of certain of his non-revenue based sales objectives. Our Chief Technology Officer and our Vice President of Products did not receive bonus in 2010, because neither one of them had a contractual right to a bonus. Our Chief Technology Officer received a significant raise in his base salary in 2010 and he had a significant equity ownership stake. Our Chief Financial Officer also received a bonus in 2010 of \$50,000, which was equal to the first year bonus for which he was eligible pursuant to his negotiated employment offer letter. This bonus was based on the recommendation of our Chief Executive Officer in light of our Chief Financial Officer's role in strengthening our financial and accounting organization and processes in 2010, such as implementing more formal controls and procedures, hiring an experienced controller and leading efforts to improve our balance sheet.

The cash bonuses paid to our named executive officers for 2010 are set forth in the "Summary Compensation Table" under "Executive Compensation."

We do not have a formal policy regarding adjustment or recovery of bonus awards or payments if the relevant performance measures upon which they are based are restated or otherwise adjusted in a manner that would have originally reduced the size of the awards or payments.

For 2011, we have developed a formalized bonus program for all employees based on input from Compensia on public company market practices for bonus plan design. For our named executive officers, we set target bonus amounts and performance goals. Our 2011 bonus plan is based 60% on achievement of corporate goals, 30% on achievement of department goals and 10% on achievement of individual performance goals. For 2011, the corporate goals are revenue and gross margin. Target bonus percentages of base salary are as follows: 50% for our Chief Executive Officer, 25% for our Chief Technology Officer, 40% for our Chief Financial Officer and 30% for our Vice President of Products. These target percentages were determined by our compensation committee based on its judgment taking into consideration the projected scaling of our business in 2011, our Chief Executive Officer's recommendations, our compensation committee's evaluation of the individual contributions and responsibilities of each executive officer and the executive compensation market data provided by Compensia that showed that overall our 2010 bonuses were lower than bonus levels for comparable public companies.

Equity Compensation

We use equity awards to incentivize and reward our executive officers, including our named executive officers, for long-term corporate performance based on the value of our common stock and, thereby, to align the interests of our executive officers with those of our stockholders.

To date, we have not applied a rigid formula in determining the size of the initial equity awards that have been granted to our named executive officers. Instead, these awards have been established through arms-length negotiation at the time of hiring. In these negotiations, our board of directors has exercised its judgment, taking into consideration, among other things, the prospective role and responsibility of the executive, competitive

[Table of Contents](#)

factors, the amount of equity-based equity compensation held by the executive officer at his or her former employer, and the cash compensation received by the executive officer. Based upon these factors, our board of directors has determined the size of each award at levels it considered appropriate to create a meaningful opportunity for reward predicated on the creation of long-term stockholder value.

Thereafter, our board of directors has granted equity awards to our executive officers, including our named executive officers, on an ad hoc basis when it deemed additional grants were appropriate. In making these awards, our board has exercised its judgment as to the amount and form of the awards, taking into consideration our performance, the board's evaluation of the expected and actual performance of each executive officer, his individual contributions and responsibilities, the dilution of the executive as a result of our financings and market conditions.

In making the allocations of both initial equity awards and additional awards, our board of directors has considered objectives such as motivating executives to achieve company objectives, providing incentives to promote our growth and create stockholder value, and aligning the financial interests of our executive officers with those of our stockholders. The board of directors has also considered the potential dilutive effect on our stockholders.

In 2010, we granted stock options to Messrs. Kumar and Loebbaka, our Chief Financial Officer and Vice President of Worldwide Sales, respectively, in connection with their initial employment with us.

- In the case of Mr. Kumar, we granted him a stock option to purchase 2,058,000 shares of our common stock with an aggregate grant date fair value of approximately \$100,000 in January 2010. The size of this award was determined based on our negotiations with Mr. Kumar, our objective of inducing Mr. Kumar to accept employment and our Board of Directors' collective experience with market practices for equity compensation for chief financial officers.
- In the case of Mr. Loebbaka, we granted him a stock option to purchase 2,217,182 shares of our common stock with an aggregate grant date fair value of approximately \$400,000 in June 2010. The size of this award was determined based on our negotiations with Mr. Loebbaka, our objective of inducing Mr. Loebbaka to accept employment and our Board of Directors' collective experience with market practices for equity compensation for top sales executives. We also took into consideration the value of our common stock at that time and our desire to ensure that there was minimal differentiation in the total compensation opportunities of our senior executive officers.

In addition, in July 2010, we granted "refresh" stock option awards to Messrs. Nahi, Kumar, and Fornage to provide them with an additional long-term incentive opportunity and to promote our retention objectives.

- In the case of Mr. Nahi, we evaluated his outstanding and unvested equity holdings and determined that it was appropriate to provide him with a stock option to purchase 4,488,911 shares of our common stock with an aggregate grant date fair value of approximately \$950,000. At that time, we believed that this award, when combined with his other equity holdings, would provide a strong incentive for him to remain with our company through a critical period of its growth and development, continue to grow our company and work toward our goal of attaining sustainable profitability.
- In the case of Mr. Kumar, we determined that, as a result of his successful performance during his tenure with our company, it was appropriate to increase his long-term incentive opportunity by providing him with a stock option to purchase 602,619 shares of our common stock with an aggregate grant date fair value of approximately \$125,000. At that time, we believed that this award was an appropriate means of rewarding his near-term performance, while, at the same time, reinforcing his ties to our company and incentivizing him to continue to successfully guide our accounting and finance organization.

[Table of Contents](#)

- In the case of Mr. Fornage, we evaluated his outstanding and unvested equity holdings and determined that it was appropriate to provide him with a stock option to purchase 3,859,680 shares of our common stock with an aggregate grant date fair value of approximately \$800,000. At that time, we believed that this award, when combined with his other equity holdings, would provide a strong incentive for him to remain with our company through a critical period of its growth and development and to continue to drive our product development.

The equity awards granted to our named executive officers during 2010 are set forth in the “Summary Compensation Table” and “Grants of Plan-Based Awards” table under “Executive Compensation.”

The equity awards granted to our named executive officers during 2010 are set forth in the “Summary Compensation Table” and “Grants of Plan-Based Awards” table under “Executive Compensation.”

To date, we have not granted any additional equity compensation to our named executive officers in 2011. Following the completion of this offering, we expect our compensation committee to oversee the development of an annual equity compensation “refresh” program.

Retirement and Other Benefits

We have established a tax-qualified Section 401(k) retirement savings plan for our executives, including our named executive officers, and other employees who satisfy certain eligibility requirements. Under this plan, participants may elect to make pre-tax contributions of up to 100% of their current compensation, not to exceed the applicable statutory income tax limitation (which is \$16,500 in 2011 for employees under 50 years of age and \$22,000 for employees who are 50 years of age or older). In 2010, we contributed three percent of each employee’s base salary into his or her 401(k) account. We are reviewing our company contribution and may revise the percentage and formula for 2012.

Additional benefits received by our executives, including our named executive officers, include medical, dental, and vision benefits, medical and dependent care flexible spending accounts, short-term and long-term disability insurance, accidental death and dismemberment insurance and basic life insurance coverage. We provide these benefits to our executives on the same basis as to all of our full-time employees. We provided relocation packages for our Chief Financial Officer and our Vice President of Worldwide Sales in connection with their initial employment. The amount of each relocation package was determined based on our arm’s-length negotiations with each executive officer, our compensation committee’s knowledge of the costs and size of executive relocation packages, as well as input from our external recruiter.

Historically, other than the relocation packages discussed above, we have not provided perquisites or other personal benefits to our executives, including our named executive officers. However, in the future we may provide such items in limited circumstances, such as when we believe it is appropriate to assist an individual in the performance of his or her duties, to make our executives more efficient and effective, and to recruit, motivate, or retain executives. All future practices with respect to perquisites or other personal benefits will be approved and subject to periodic review by our compensation committee.

Post-Employment Compensation

In connection with the hiring of each of our named executive officers, we entered into an employment agreement or offer letter that typically provided for his base salary, bonus opportunity, initial stock option grant, employee benefits and, in some cases, potential benefits upon a termination of employment, including a termination of employment following a change in control of us. In June 2011, our compensation committee and board of directors undertook a review of these termination benefits across our executive team. As a result of this review, the committee and our board determined that these arrangements should be updated to provide more consistency for these benefits among our executives as well as provide benefits that we and Compensia believe

[Table of Contents](#)

are generally comparable to our peer group of companies. Accordingly, our board of directors approved our entering into new executive severance agreements with Mr. Nahi, Mr. Belur and Mr. Fornage, and new change in control and severance agreements with Mr. Kumar, Mr. Loebbaka and our other executive officers. For a summary of the material terms and conditions of the employment agreements for our named executive officers, see “Executive Compensation—Employment Agreements.”

We believe that the severance and change in control benefits set forth in each named executive officer’s employment agreement assisted us in attracting our executive officers. We also believe that these benefits help our executive officers maintain continued focus and dedication to their assigned duties to maximize stockholder value if there is a potential transaction that could involve a change in control of our company. For a summary of the material terms and conditions of these provisions, see “Executive Compensation—Potential Payments Upon Termination or Change in Control.”

Tax and Accounting Considerations

Deductibility of Executive Compensation

As a private company, in making our compensation decisions, we have not considered Section 162(m) of the Internal Revenue Code, or the Code, which disallows a tax deduction to any publicly-held corporation for any remuneration in excess of \$1 million paid in any taxable year to its chief executive officer and each of its other named executive officers (other than its chief financial officer) unless an exception applies. We expect our compensation arrangements put in place prior to our initial public offering and for several years thereafter will be exempt under Section 162(m) of the Code.

Once our exemption period expires, we expect that our compensation committee will adopt a policy that, where reasonably practicable, will qualify the variable compensation paid to our executive officers for the “performance-based compensation” exemption from the deductibility limit. Our compensation committee may, in its judgment, authorize compensation payments that do not comply with an exemption from the deductibility limit when it believes that such payments are appropriate to attract and retain executive talent.

Taxation of “Parachute” Payments

Sections 280G and 4999 of the Code provide that executive officers and directors who hold significant equity interests and certain other service providers may be subject to an excise tax if they receive payments or benefits in connection with a change in control of our company that exceeds certain prescribed limits, and that our company (or a successor) may forfeit a deduction on the amounts subject to this additional tax. We do not currently provide any executive, including any named executive officer, with a “gross-up” or other reimbursement payment for any tax liability that he may owe as a result of the application of Sections 280G or 4999.

EXECUTIVE COMPENSATION

Summary Compensation Table

The following table provides information for the year ended December 31, 2010 regarding the compensation of our principal executive officer, principal financial officer, and each of our three other most highly compensated persons serving as executive officers. We refer to these persons as our named executive officers.

<u>Name and Principal Position</u>	<u>Year</u>	<u>Salary</u>	<u>Bonus⁽¹⁾</u>	<u>Option Awards⁽²⁾</u>	<u>Non-Equity Incentive Plan Compensation</u>	<u>All Other Compensation</u>	<u>Total</u>
Paul B. Nahi President and Chief Executive Officer	2010	\$243,077	\$30,000	\$952,319	\$ 10,000 ⁽³⁾	\$ 7,431 ⁽⁴⁾	\$1,242,827
Sanjeev Kumar Chief Financial Officer	2010	225,000	—	224,924	50,000 ⁽⁵⁾	71,305 ⁽⁶⁾	571,229
Martin Fornage Chief Technology Officer	2010	225,000	—	818,828	—	8,256 ⁽⁷⁾	1,052,084
Jeff Loebbaka Vice President of Worldwide Sales	2010	147,115 ⁽⁸⁾	—	396,889	133,325 ⁽⁹⁾	22,180 ⁽¹⁰⁾	699,509
Raghuveer R. Belur Vice President of Products	2010	160,000	—	594,018	—	4,881 ⁽¹¹⁾	758,899

- (1) Amounts reported in column reflect discretionary cash bonuses determined by the board of directors.
- (2) Amounts reported in column reflect the aggregate grant date fair value of stock options granted pursuant to our 2006 Equity Incentive Plan in 2010, calculated in accordance with applicable accounting guidance for share-based payment transactions and excludes the impact of estimated forfeitures related to service-based vesting conditions. The valuation assumptions used in determining such amounts are described in Note 10 to our consolidated financial statements appearing elsewhere in this prospectus.
- (3) Amount reflects a cash bonus determined by the board of directors pursuant to Mr. Nahi's achievement against certain pre-determined performance criteria. For more information regarding Mr. Nahi's performance plan-based cash bonus, see "Compensation Discussion and Analysis—Executive Compensation Program Components."
- (4) Amount reflects contributions by us of \$7,350 to Mr. Nahi's 401(k) account and \$81 paid by us on Mr. Nahi's behalf for basic life insurance premiums.
- (5) Mr. Kumar's cash bonus was paid in advance in the form of a loan in a principal amount of \$50,000, which loan was subsequently forgiven following Mr. Kumar's achievement of certain bonus related performance targets. For more information regarding Mr. Kumar's cash bonus and related loan forgiveness, see "Certain Relationships and Related Party Transactions—Loan to Officer."
- (6) Amount reflects \$294 in interest forgiven by us and a tax gross-up of \$3,019 paid by us in connection with the advance payment of Mr. Kumar's cash bonus in the form of a loan and subsequent loan forgiveness; relocation benefits consisting of temporary housing, destination and relocation bonus amounts totaling \$61,161; contributions by us of \$6,750 to Mr. Kumar's 401(k) account; and \$81 paid by us on Mr. Kumar's behalf for basic life insurance premiums. For more information regarding Mr. Kumar's cash bonus and related loan forgiveness, see "Certain Relationships and Related Party Transactions—Loan to Officer."
- (7) Amount reflects contributions by us of \$6,750 to Mr. Fornage's 401(k) account, \$81 paid by us on Mr. Fornage's behalf for basic life insurance premiums and \$1,425 paid by us on Mr. Fornage's behalf for additional life insurance premiums.
- (8) Amount represents salary starting from May 3, 2010, Mr. Loebbaka's employment start date.
- (9) Amount reflects \$133,325 paid to Mr. Loebbaka under our sales commission plan. For more information regarding Mr. Loebbaka's sales commission plan-based bonus, see "Compensation Discussion and Analysis—Executive Compensation Program Components."
- (10) Amount reflects relocation benefits consisting of temporary housing and relocation bonus amounts totaling \$22,133, and contributions by us of \$47 paid on Mr. Loebbaka's behalf for basic life insurance premiums.
- (11) Amount reflects contributions by us of \$4,800 to Mr. Belur's 401(k) account and \$81 paid by us on Mr. Belur's behalf for basic life insurance premiums.

Grants of Plan-Based Awards

The following table provides information regarding grants of plan-based awards to each of our named executive officers during 2010.

Name	Grant Date	Estimated Possible Payouts Under Non-Equity Incentive Plan Awards			All Other Option Awards: Number of Securities Underlying Options	Exercise or Base Price of Option Awards (per Share) ⁽¹⁾	Grant Date Fair Value of Stock and Option Awards ⁽²⁾
		Threshold	Target	Maximum			
Paul B. Nahi	7/15/2010	\$ 10,000 ⁽³⁾	—	\$ 50,000 ⁽³⁾	4,488,911 ⁽⁴⁾	\$ 0.18	\$ 952,319
Sanjeev Kumar	1/15/2010	—	50,000 ⁽⁵⁾	—	2,058,000 ⁽⁶⁾	0.07	97,079
	7/15/2010	—	—	—	602,619 ⁽⁴⁾	0.18	127,845
Martin Fornage	7/15/2010	—	—	—	3,859,680 ⁽⁴⁾	0.18	818,828
Jeff Loebbaka	6/3/2010	—	—	145,000 ⁽⁷⁾	2,217,182 ⁽⁸⁾	0.18	396,889
Raghuveer R. Belur	7/15/2010	—	—	—	2,800,000 ⁽⁴⁾	0.18	594,018

- (1) Our common stock was not publicly traded during 2010, and the exercise price of the options was determined by our board of directors based on its determination of the fair market value of our common stock on the grant date. For more information on our methodology for determining the exercise price of the options, see “Management’s Discussion and Analysis of Financial Condition and Results of Operations—Critical Accounting Policies and Significant Management Estimates—Stock-Based Compensation” appearing elsewhere in this prospectus.
- (2) In accordance with SEC rules, this column represents the aggregate grant date fair value of each equity award, calculated in accordance with applicable accounting guidance for stock-based payment transactions. For additional information on the valuation assumptions underlying the value of these awards, see Note 10 to our consolidated financial statements appearing elsewhere in this prospectus. For more information on our methodology for determining the exercise price of the options, see “Management’s Discussion and Analysis of Financial Condition and Results of Operations—Critical Accounting Policies and Significant Management Estimates—Stock-Based Compensation” appearing elsewhere in this prospectus.
- (3) Reflects the minimum threshold and maximum amounts payable to Mr. Nahi pursuant to his performance plan-based cash bonus for the year ended December 31, 2010. No target amount other than the maximum amount was established. For more information regarding Mr. Nahi’s performance plan-based cash bonus, see “Compensation Discussion and Analysis—Executive Compensation Program Components.” The actual cash bonus award earned by Mr. Nahi for the year ended December 31, 2010 is set forth in the “Summary Compensation Table” set forth above.
- (4) The option was granted pursuant to our 2006 Equity Incentive Plan and vests on a monthly basis in equal increments during the four-year period from a vesting commencement date of May 21, 2010.
- (5) Reflects the target amount payable to Mr. Kumar upon the achievement of his management bonus objectives for the year ended December 31, 2010. No minimum threshold or maximum amounts beyond the target amount were established. For more information regarding Mr. Kumar’s performance plan-based cash bonus, see “Compensation Discussion and Analysis—Executive Compensation Program Components.” The actual cash bonus award earned by Mr. Kumar for the year ended December 31, 2010 is set forth in the “Summary Compensation Table” set forth above.
- (6) The option was granted pursuant to our 2006 Equity Incentive Plan and vests over four years from a vesting commencement date of November 30, 2009, with the first 25% vesting on November 30, 2010, and monthly thereafter with respect to 2.08% of the number of shares covered by such option beginning on December 1, 2010 and on the 1st of each of the 36 months thereafter.
- (7) Reflects the maximum amount payable to Mr. Loebbaka pursuant to our sales commission plan for Mr. Loebbaka for the year ended December 31, 2010. No minimum threshold or target amounts other than the maximum amount were established. For more information regarding Mr. Loebbaka’s sales commission plan-based bonus, see “Compensation Discussion and Analysis—Executive Compensation Program Components.” The actual sales commission award earned by Mr. Loebbaka for the year ended December 31, 2010 is set forth in the “Summary Compensation Table” set forth above.
- (8) The option was granted pursuant to our 2006 Equity Incentive Plan and vests over four years from a vesting commencement date of May 3, 2010, with the first 25% vesting on May 3, 2011, and monthly thereafter with respect to 2.08% of the number of shares covered by such option beginning on June 1, 2011.

The material terms of the named executive officers’ offer letters and employment agreements are described in greater detail below under the section titled “Employment Agreements.” The explanations of the amounts of compensation awarded in 2010, including how each individual element of compensation was determined, are set forth in the section titled “Compensation Discussion and Analysis.”

[Table of Contents](#)

Outstanding Equity Awards at December 31, 2010

The following table presents certain information concerning outstanding equity awards held by each of our named executive officers as of December 31, 2010.

Name	Option awards				Stock awards	
	Number of Securities Underlying Unexercised Options Exercisable ⁽¹⁾	Number of Securities Underlying Unexercised Options Unexercisable ⁽¹⁾	Option Exercise Price ⁽²⁾ (\$)	Option Expiration Date	Number of Shares of Stock That Have Not Vested (#)	Market Value of Shares of Stock That Have Not Vested (\$) ⁽³⁾
Paul B. Nahi	800,000 ⁽⁴⁾	—	\$ 0.26	6/25/2018	19,834 ⁽⁵⁾	\$
	3,437,627	4,812,679 ⁽⁶⁾	0.03	7/15/2019	6,042 ⁽⁵⁾	
	654,632	3,834,279 ⁽⁷⁾	0.18	7/14/2020		
Sanjeev Kumar	557,375	1,500,625 ⁽⁸⁾	0.07	1/14/2020		
	87,881	514,738 ⁽⁷⁾	0.18	7/14/2020		
Martin Fornage	3,508,973	4,912,564 ⁽⁶⁾	0.03	7/15/2019		
	562,870	3,296,810 ⁽⁷⁾	0.18	7/14/2020		
Jeff Loebbaka	—	2,217,172 ⁽⁹⁾	0.18	6/2/2020		
Raghuv eer R. Belur	2,713,781	3,799,295 ⁽⁶⁾	0.03	7/15/2019		
	408,333	2,391,667 ⁽⁷⁾	0.18	7/14/2020		

- (1) Vesting of each stock option is contingent upon the executive officer's continued service, except as may be accelerated on certain events described below under "Potential Payments Upon Termination or Change in Control."
- (2) For more information on our methodology for determining the exercise price of the options, see "Management's Discussion and Analysis of Financial Condition and Results of Operations—Critical Accounting Policies and Significant Management Estimates—Stock-Based Compensation" appearing elsewhere in this prospectus.
- (3) The market value of the unvested shares of restricted stock has been calculated assuming a price per share of \$, which is the mid-point of the price range set forth on the cover page of this prospectus, multiplied by the number of unvested shares.
- (4) The shares subject to the stock option are early exercisable and vest over a four-year period, with 1/4th of the shares vested on January 1, 2008, and the remainder vesting in 36 equal monthly installments on the first day of each succeeding calendar month thereafter.
- (5) The shares subject to the stock award are released from the repurchase option over a four-year period, with 1/4th of the shares subject to the stock award vested and released from the repurchase option on January 1, 2008, and the remainder vesting and being released from the repurchase option in 36 equal monthly installments thereafter.
- (6) The shares subject to the stock option vest over a four-year period commencing April 24, 2009, with 1/48th of the shares vesting on a monthly basis.
- (7) The shares subject to the stock option vest over a four-year period commencing May 21, 2010, with 1/48th of the shares vesting on a monthly basis.
- (8) The shares subject to the stock option vest over a four-year period, with 1/4th of the shares vested on November 30, 2010, and the remainder vesting in 36 equal monthly installments on the first day of each succeeding calendar month thereafter.
- (9) The shares subject to the stock option vest over a four-year period, with 1/4th of the shares vested on May 3, 2011, and the remainder vesting in 36 equal monthly installments on the first day of each succeeding calendar month thereafter.

[Table of Contents](#)

Option Exercises and Stock Vested

The following table shows information regarding the vesting of restricted stock held by our named executive officers during 2010. There were no option exercises in 2010.

	<u>Name</u>	<u>Stock Awards</u>	
		<u>Number of Shares Acquired on Vesting (#)</u>	<u>Value Realized on Vesting (\$) (1)</u>
	Paul B. Nahi	310,500	\$
	Sanjeev Kumar	—	
	Martin Fornage	—	
	Jeff Loebbaka	—	
	Raghuvveer R. Belur	—	

(1) The value realized upon vesting was calculated by multiplying the number of shares of common stock that vested during 2010 by an assumed initial public offering price of \$ _____, the midpoint of the price range set forth on the cover page of this prospectus. More information about the restricted stock held by Mr. Nahi can be found under "Employment Agreements" below.

Employment Agreements

Definitions

Except as otherwise set forth below, for purposes of the employment related agreements entered into with our named executive officers, the following definitions apply:

"*Cause*" means (i) gross negligence or willful misconduct in the performance of duties to us where such gross negligence or willful misconduct has resulted or is likely to result in substantial and material damage to us or our subsidiaries; (ii) a material failure to comply with our written policies after having received from us notice of, and a reasonable time to cure, such failure; (iii) repeated unexplained or unjustified absence from us; (iv) conviction of a felony or a crime involving moral turpitude causing material harm to our standing and reputation; or (v) unauthorized use or disclosure of any proprietary information or trade secrets of us or any other party to whom he owes an obligation of non-disclosure as a result of his relationship with us, which use or disclosure causes or is likely to cause us material harm. Cause is determined by our board of directors acting in good faith and based on information then known to it.

"*Change in Control*" means (i) any sale or exchange of the capital stock by our shareholders in one transaction or series of related transactions where more than 50% of our outstanding voting power is acquired by a person or entity or group of related persons or entities, (ii) any reorganization, consolidation or merger of us where our outstanding voting securities immediately before the transaction represent or are converted into less than fifty percent 50% of the outstanding voting power of the surviving entity (or its parent corporation) immediately after the transaction, (iii) the consummation of any transaction or series of related transactions that results in the sale of all or substantially all of our assets or (iv) any "person" or "group" (as defined in the Securities Exchange Act of 1934, as amended) becoming the "beneficial owner" (as defined in Rule 13d-3 under said Act) directly or indirectly of securities representing more than 50% of the voting power of our stock then outstanding.

"*Good Reason*" means, without his written consent, (i) a material reduction or change in job duties, responsibilities or authority inconsistent with his position with us and his prior duties, responsibilities or authority, provided, however, that any change in his position after a Change in Control shall not constitute grounds for a termination for Good Reason so long as he remains a member of our senior management (or becomes a member of the senior management of the surviving or acquiring entity) at the same or higher base salary as immediately prior to the Change in Control with equivalent authority and responsibility, (ii) a material reduction of his then current base salary by more than 10%, excluding an across the board reduction in the salary

[Table of Contents](#)

level of other of our executives by the same percentage as part of a general salary level reduction; (iii) a relocation of the principal place for performance of his duties to us to a location more than 40 miles from our then current location; or (iv) a material breach by us of the executive's employment or executive agreement provided that he gives us written notice of the event forming the basis of the Good Reason resignation within 60 days of the date we give written notice to him of our affirmative decision to take an action set forth above, we fail to cure such basis for the Good Reason resignation within 30 days after receipt of his written notice and he terminates employment within 30 days following the expiration of the cure period.

"Termination for Disability." For the employment agreements of Mr. Fornage and Mr. Belur, "Termination for Disability" means our determination made in good faith that, due to a mental or physical incapacity, he has been unable to perform his employment duties for a period of not less than six consecutive months or 180 days in the aggregate in any twelve-month period unless he has been on leave approved by our board of directors.

Paul B. Nahi

On January 1, 2007, we entered into an offer letter with Mr. Nahi to serve as our President and Chief Executive Officer, on an at-will basis. The offer letter provided for an initial annual base salary of \$60,000 per year, which has subsequently increased to the current amount of \$250,000 per year. The letter also provided for the opportunity to purchase 952,000 shares of our restricted common stock and a commitment by us to issue, upon the final closing of our Series B preferred stock financing, an additional number of shares of common stock to bring his total equity ownership to 6.5% of the number of fully-diluted shares of common stock then outstanding (which issuance was subsequently completed in September 2008). The letter indicates Mr. Nahi's general eligibility for employee benefits, additional stock grants and long-term incentives. In June 2011, we entered into an executive severance agreement with Mr. Nahi that provides for the payment of severance benefits to Mr. Nahi in the event of the termination of his employment in the scenarios described below. This agreement superseded the severance provisions contained in Mr. Nahi's original offer letter.

Termination Without Cause or Resignation for Good Reason. Under the executive severance agreement, in the event that we terminate Mr. Nahi's employment without Cause or he voluntarily resigns for Good Reason, subject to signing an effective release of claims, Mr. Nahi will receive the following severance benefits: (i) six months' base salary and health insurance benefits paid over the six month severance period on our normal payroll dates, and (ii) 25% of each outstanding equity award shall automatically become immediately vested. In addition, each vested and unexercised equity award shall remain exercisable for a period of 12 months following such termination or resignation.

Termination Without Cause or Resignation with Good Reason in Connection With or Following a Change in Control. Under the executive severance agreement, in the event that we terminate Mr. Nahi's employment without Cause or he voluntarily resigns with Good Reason in connection with or within 24 months after a Change in Control, subject to signing an effective release of claims, Mr. Nahi will receive the following severance benefits: (i) six months' base salary and health insurance benefits paid over the six month severance period on our normal payroll dates, and (ii) 100% of each outstanding equity award shall automatically become immediately vested. In addition, each vested and unexercised equity award shall remain exercisable for a period of 12 months following such termination or resignation.

Sanjeev Kumar

On November 12, 2009, we entered into an offer letter with Mr. Kumar to serve as our Chief Financial Officer, on an at-will basis. The offer letter provided for an initial annual base salary of \$225,000 per year and an initial stock option grant to purchase up to 2,058,000 shares of our common stock. The letter also provided for a loan in the amount of \$50,000, which was evidenced by a full-recourse promissory note dated June 14, 2010. The letter indicates Mr. Kumar's eligibility for reimbursement of up to \$55,000 in qualified relocation expenses. In November 2010, in light of Mr. Kumar's achievement of certain bonus performance targets, the outstanding

[Table of Contents](#)

principal and accrued interest under the loan was forgiven and the note was cancelled. The letter also indicates Mr. Kumar's general eligibility for annual variable pay based on completion of performance objectives, stock option grants and long-term incentives. In June 2011, we entered into a change in control agreement with Mr. Kumar that provides for the payment of severance benefits to Mr. Kumar in the event of the termination of his employment following a change in control in the scenarios described below. This agreement superseded the severance provisions contained in Mr. Kumar's original offer letter.

Termination Without Cause or Resignation for Good Reason in Connection With or Following a Change in Control. Under the change in control agreement, in the event that we terminate Mr. Kumar's employment without Cause or he voluntarily resigns for Good Reason in connection with or within 24 months after a Change in Control, subject to signing an effective release of claims, Mr. Kumar will receive the following severance benefits: (i) six months' base salary and health insurance benefits paid out over the six month severance period on our normal payroll dates, and (ii) 100% of each outstanding equity award shall automatically become immediately vested.

Martin Fornage

On March 21, 2006, we entered into an employment agreement with Mr. Fornage to serve as our Chief Technology Officer, on an at-will basis. The employment agreement provided for an initial annual base salary of \$60,000 per year, which has subsequently been increased to the current amount of \$225,000 per year. The agreement indicates Mr. Fornage's general eligibility for an annual cash bonus in the discretion of the Board of Directors, employee benefits and stock option grants. In June 2011, we entered into an executive severance agreement with Mr. Fornage that provides for the payment of severance benefits to Mr. Fornage in the event of the termination of his employment in the scenarios described below. This agreement superseded the severance provisions contained in Mr. Fornage's original employment agreement, as amended.

Termination Without Cause, Resignation for Good Reason or Termination for Disability. Under the executive severance agreement, in the event that we terminate Mr. Fornage's employment without Cause or he voluntarily resigns for Good Reason, subject to signing an effective release of claims, Mr. Fornage will receive the following severance benefits: (i) six months' base salary and annual cash bonus, if any, payable over the six-month severance period on our normal payroll dates, and six months' health insurance benefits paid out over the severance period, and (ii) 100% of each outstanding equity award shall automatically become immediately vested. In the event of Termination for Disability, Mr. Fornage will receive the following severance benefits: six months' base salary and annual cash bonus, if any, payable over the six month severance period on our normal payroll dates, and six months' health insurance benefits paid out over the severance period.

Jeff Loebbaka

On April 19, 2010, we entered into an offer letter with Mr. Loebbaka to serve as our Vice President of Worldwide Sales, on an at-will basis. The offer letter provides for an initial annual base salary of \$225,000 per year. The letter also provides for a proposed initial stock option grant to purchase up to 2,217,182 shares of our common stock, subject to approval of our board of directors. The letter indicates Mr. Loebbaka's eligibility for incentive compensation of up to \$145,000 during his first twelve months of employment based on completion of sales targets and reimbursement of up to \$50,000 in qualified relocation expenses. The letter also indicates Mr. Loebbaka's general eligibility for annual variable pay based on completion of performance objectives, stock option grants and long-term incentives. The letter further provides that in the event that we terminate Mr. Loebbaka's employment without Cause prior to the twelve month anniversary of his first day of employment, Mr. Loebbaka would receive the following severance benefits; three months' base salary and three months' health benefit insurance premiums paid out over the three month severance period on our normal payroll dates. Our obligation to provide these severance benefits expired in April 2011. In June 2011, we entered into a change in control agreement with Mr. Loebbaka that provides for the payment of severance benefits to Mr. Loebbaka in the event of the termination of his employment following a change in control in the scenarios described below. This agreement superseded the severance provisions contained in Mr. Loebbaka's original offer letter.

[Table of Contents](#)

Termination Without Cause or Resignation for Good Reason in Connection With or Following a Change in Control. Under the change in control agreement, in the event that we terminate Mr. Loebbaka's employment without Cause or he voluntarily resigns for Good Reason in connection with or within 24 months after a change in control, subject to signing an effective release of claims, Mr. Loebbaka will receive the following severance benefits: (i) three months' base salary and health insurance benefits paid out over the three month severance period and (ii) 100% of each outstanding equity award shall automatically become immediately vested.

Raghuveer R. Belur

On March 21, 2006, we entered into an employment agreement with Mr. Belur to serve as our Vice President of Products, on an at-will basis. The employment agreement provided for an initial annual base salary of \$60,000 per year, which has subsequently been increased to the current amount of \$160,000 per year. The agreement indicates Mr. Belur's general eligibility for an annual cash bonus in the discretion of the Board of Directors, employee benefits and stock option grants. In June 2011, we entered into an executive severance agreement with Mr. Belur that provides for the payment of severance benefits to Mr. Belur in the event of the termination of his employment in the scenarios described below. This agreement superseded the severance provisions contained in Mr. Belur's original employment agreement, as amended.

Termination Without Cause, Resignation for Good Reason or Termination for Disability. Under the executive severance agreement, in the event that we terminate Mr. Belur's employment without Cause or he voluntarily resigns for Good Reason, subject to signing an effective release of claims, Mr. Belur will receive the following severance benefits: (i) six months' base salary and annual cash bonus, if any, payable over the six month severance period on our normal payroll dates, and six months' health insurance benefits paid out over the severance period, and (ii) 100% of each outstanding equity award shall automatically become immediately vested. In the event of Termination for Disability, Mr. Belur will receive the following severance benefits: six months' base salary and annual cash bonus, if any, payable over the six-month severance period on our normal payroll dates, and six months' health insurance benefits paid out over the severance period.

Potential Payments Upon Termination or Change in Control

The section below describes the payments that we would have made to our named executive officers in connection with certain terminations of employment and/or certain corporate transactions like a change in control, if such events had occurred on December 31, 2010. For further information, see the section above entitled "Executive Compensation—Employment Agreements."

Potential Payments Upon a Change in Control, Stock Awards Not Assumed

Pursuant to our 2006 Equity Incentive Plan, in the event that there had been a Corporate Transaction (as defined below) on December 31, 2010, and if the surviving or acquiring corporation had elected not to assume or substitute for outstanding options (or assume the repurchase rights held in respect of shares purchased under such options or awards, as applicable), the vesting of outstanding options or awards held by each of our named executive officers on such date would have accelerated (and the repurchase rights with respect to the shares issued upon exercise of such options or under the awards would have lapsed) by one calendar month for each calendar month the named executive officer had been employed by us, up to a maximum of twelve months, in addition to any other applicable vesting.

For purposes of our 2006 Equity Incentive Plan, "Corporate Transaction" means (i) a dissolution or liquidation of our company, (ii) a merger or consolidation after which our stockholders immediately prior to such merger (other than any stockholder which merges, or which owns or controls another entity that merges, with us in such merger) cease to own at least a majority of their shares of our capital stock, (iii) the sale of substantially all of our assets in one transaction or series of related transactions followed by the liquidation of our company, or (iv) the sale by our stockholders of at least a majority of the outstanding shares of our capital stock in one transaction or series of related transactions.

Table of Contents

For purposes of the section below, “Constructive Termination” means, with respect to the employment agreements of each of Mr. Fornage and Mr. Belur (as they existed on December 31, 2010), (i) a material reduction in salary not agreed to by him, (ii) a material change in responsibilities not agreed to by him, (iii) our failure to comply in any material respect with any material term of his employment agreement, which shall include a material reduction in the type or level of benefits set forth in the employment agreement, not agreed to by him, (iv) a requirement that he relocate to an office that would increase his one-way commute distance by more than 40 miles, or (v) a Change in Control, which also includes an event after which less than a majority of the board of directors consists of persons either nominated for election or elected by the board of directors.

2010 Potential Payments Upon Termination or Change in Control

The following tables show the amounts each of our named executive officers would receive in the event of his or her termination and/or upon a change in control, assuming the event took place on December 31, 2010, the last business day of our most recently completed fiscal year. All severance benefits are contingent upon the individual’s execution of a general release of all claims.

Named Executive Officer	Termination or Change in Control Event ⁽¹⁾	Salary (\$)	Bonus (\$)	Benefits (\$)	Equity Acceleration (\$) ⁽²⁾	Total (\$)
Paul B. Nahi	Termination without cause or resignation with good reason	\$ 57,692 ⁽³⁾	\$ —	\$ 2,507 ⁽⁴⁾	\$ —	\$ —
	*Termination without cause or resignation with good reason	115,384 ⁽⁵⁾	—	5,014 ⁽⁶⁾	—	—
	Change in control—awards assumed and termination without cause or resignation with good reason ⁽⁷⁾	57,692 ⁽³⁾	—	2,507 ⁽⁴⁾	—	—
	*Change in control—awards assumed and termination without cause or resignation with good reason ⁽⁷⁾	115,384 ⁽⁵⁾	—	5,014 ⁽⁶⁾	—	—
	Change in control—awards not assumed and termination without cause or resignation with good reason ⁽⁸⁾	57,692 ⁽³⁾	—	2,507 ⁽⁴⁾	—	—
	*Change in control—awards not assumed and termination without cause or resignation with good reason ⁽⁸⁾	115,384 ⁽⁵⁾	—	5,014 ⁽⁶⁾	—	—
	Change in control—awards not assumed and continued employment ⁽⁹⁾	—	—	—	—	—
	*Change in control—awards not assumed and continued employment ⁽⁹⁾	—	—	—	—	—
	Sanjeev Kumar	Termination without cause or resignation for good reason	—	—	—	—
*Termination without cause or resignation for good reason	—	—	—	—	—	
Change in control—awards assumed and termination without cause or resignation for good reason ⁽⁷⁾	155,769 ⁽¹⁰⁾	—	7,346 ⁽¹¹⁾	—	—	
*Change in control—awards assumed and termination without cause or resignation for good reason ⁽⁷⁾	103,846 ⁽⁵⁾	—	4,897 ⁽⁶⁾	—	—	
Change in control—awards not assumed and termination without cause or resignation for good reason ⁽⁸⁾	155,769 ⁽¹⁰⁾	—	7,346 ⁽¹¹⁾	—	—	
*Change in control—awards not assumed and termination without cause or resignation for good reason ⁽⁸⁾	103,846 ⁽⁵⁾	—	4,897 ⁽⁶⁾	—	—	
Change in control—awards not assumed and continued employment ⁽⁹⁾	—	—	—	—	—	
*Change in control—awards not assumed and continued employment ⁽⁹⁾	—	—	—	—	—	
Martin Fornage	Constructive termination or termination without cause	103,846 ⁽⁵⁾	— ⁽¹²⁾	4,906 ⁽⁶⁾	—	—
	Termination for disability	103,846 ⁽⁵⁾	— ⁽¹²⁾	4,906 ⁽⁶⁾	—	—
	*Termination without cause or resignation for good reason	103,846 ⁽⁵⁾	— ⁽¹²⁾	4,906 ⁽⁶⁾	—	—
	Change in control—awards assumed and termination without cause or constructive termination ⁽¹³⁾	103,846 ⁽⁵⁾	— ⁽¹²⁾	4,906 ⁽⁶⁾	—	—

Table of Contents

Named Executive Officer	Termination or Change in Control Event ⁽¹⁾	Salary (\$)	Bonus (\$)	Benefits (\$)	Equity Acceleration (\$) ⁽²⁾	Total (\$)
	*Change in control—awards assumed and termination without cause or resignation for good reason ⁽⁷⁾	103,846 ⁽⁵⁾	— ⁽¹²⁾	4,906 ⁽⁶⁾		
	Change in control—awards not assumed and termination without cause or constructive termination ⁽¹⁴⁾	103,846 ⁽⁵⁾	— ⁽¹²⁾	4,906 ⁽⁶⁾		
	*Change in control—awards not assumed and termination without cause or resignation for good reason ⁽⁸⁾	103,846 ⁽⁵⁾	— ⁽¹²⁾	4,906 ⁽⁶⁾		
	Change in control—awards not assumed and continued employment ⁽⁹⁾	—	—	—		
	*Change in control—awards not assumed and continued employment ⁽⁹⁾	—	—	—		
Jeff Loebbaka	Termination without cause	58,750 ⁽³⁾	—	2,453 ⁽⁴⁾		
	*Termination without cause or resignation for good reason	—	—	—		
	Change in control—awards assumed and termination without cause ⁽¹⁵⁾	58,750 ⁽³⁾	—	2,453 ⁽⁴⁾		
	*Change in control—awards assumed and termination without cause or resignation for good reason ⁽⁷⁾	58,750 ⁽³⁾	—	2,453 ⁽⁴⁾		
	Change in control—awards not assumed and termination without cause ⁽¹⁶⁾	58,750 ⁽³⁾	—	2,453 ⁽⁴⁾		
	*Change in control—awards not assumed and termination without cause or resignation for good reason ⁽⁸⁾	58,750 ⁽³⁾	—	2,453 ⁽⁴⁾		
	Change in control—awards not assumed and continued employment ⁽⁹⁾	—	—	—		
	*Change in control—awards not assumed and continued employment ⁽⁹⁾	—	—	—		
Raghuveer R. Belur	Constructive termination or termination without cause	73,846 ⁽⁵⁾	— ⁽¹²⁾	116 ⁽⁶⁾		
	Termination for disability	73,846 ⁽⁵⁾	— ⁽¹²⁾	116 ⁽⁶⁾		
	*Termination without cause or resignation for good reason	73,846 ⁽⁵⁾	— ⁽¹²⁾	116 ⁽⁶⁾		
	Change in control—awards assumed and termination without cause or constructive termination ⁽¹³⁾	73,846 ⁽⁵⁾	— ⁽¹²⁾	116 ⁽⁶⁾		
	*Change in control—awards assumed and termination without cause or resignation for good reason ⁽⁷⁾	73,846 ⁽⁵⁾	— ⁽¹²⁾	116 ⁽⁶⁾		
	Change in control—awards not assumed and termination without cause or constructive termination ⁽¹⁴⁾	73,846 ⁽⁵⁾	— ⁽¹²⁾	116 ⁽⁶⁾		
	*Change in control—awards not assumed and termination without cause or resignation for good reason ⁽⁸⁾	73,846 ⁽⁵⁾	— ⁽¹²⁾	116 ⁽⁶⁾		
	Change in control—awards not assumed and continued employment ⁽⁹⁾	—	—	—		
	*Change in control—awards not assumed and continued employment ⁽⁹⁾	—	—	—		

* Assumes that such named executive officer's executive severance or change in control and severance agreement dated June 14, 2011 was effective as of December 31, 2010.

(1) No compensation is payable where there is a change in control, awards are assumed and employment continues.

(2) The value realized is the gain that our named executive officers would receive, calculated as the difference between an assumed initial public offering price of \$ _____, the midpoint of the price range set forth on the cover page of this prospectus and the exercise price of the named executive officers' unvested options or awards subject to acceleration following a change in control event.

(3) Represents three months' base salary calculated at a rate in effect on December 31, 2010.

(4) Represents three months' of continued health insurance coverage for such named executive officer at the applicable benefit rate for 2010.

(5) Represents six months' base salary calculated at a rate in effect on December 31, 2010.

(6) Represents six months' of continued health insurance coverage for such named executive officer at the applicable benefit rate for 2010.

Table of Contents

- (7) Represents benefits received by such named executive officer upon a change in control in which the surviving or acquiring entity elects to assume or substitute outstanding options or awards concurrent with the termination without cause of or resignation with good reason by such named executive officer.
- (8) Represents benefits received by such named executive officer upon a change in control in which the surviving or acquiring corporation elects not to assume or substitute outstanding options or awards concurrent with the termination without cause of or resignation with good reason by such named executive officer.
- (9) Represents benefits received by such named executive officer upon a change in control in which the surviving or acquiring corporation elects not to assume or substitute outstanding options or awards and such named executive officer's employment continues.
- (10) Represents nine months' base salary calculated at a rate in effect on December 31, 2010.
- (11) Represents nine months' of continued health insurance coverage for such named executive officer at the applicable benefit rate for 2010.
- (12) Represents 50% of target bonus for such named executive officer for 2010.
- (13) Represents benefits received by such named executive officer upon a change in control in which the surviving or acquiring entity elects to assume or substitute outstanding options or awards concurrent with the termination without cause or constructive termination of such named executive officer.
- (14) Represents benefits received by such named executive officer upon a change in control in which the surviving or acquiring corporation elects not to assume or substitute outstanding options or awards concurrent with the termination without cause or constructive termination of such named executive officer.
- (15) Represents benefits received by such named executive officer upon a change in control in which the surviving or acquiring entity elects to assume or substitute outstanding options or awards concurrent with the termination without cause of such named executive officer.
- (16) Represents benefits received by such named executive officer upon a change in control in which the surviving or acquiring corporation elects not to assume or substitute outstanding options or awards concurrent with the termination without cause of such named executive officer.

Employee Benefit Plans

2006 Equity Incentive Plan

Our board of directors adopted, and our stockholders approved, the 2006 Equity Incentive Plan, as amended, or 2006 Plan, in March 2006. The 2006 Plan provides for the grant of incentive stock options, nonstatutory stock options and rights to acquire restricted stock. Upon the execution and delivery of the underwriting agreement for this offering, no additional stock options or other stock awards will be granted under the 2006 Plan. All outstanding stock options and other stock awards previously granted under the 2006 Plan will remain subject to the terms of the 2006 Plan.

Share Reserve. There are 68,400,797 shares of common stock reserved for issuance under the 2006 Plan. As of June 30, 2011, 6,262,887 shares of common stock had been issued upon the exercise of stock options or pursuant to stock awards granted under the 2006 Plan, net of repurchases, options to purchase 53,885,595 shares of common stock were outstanding at a weighted-average exercise price of \$0.13 per share and 8,252,315 shares remained available for future grant under the 2006 Plan. Following the completion of this offering, no further grants will be made under the 2006 Plan.

Administration. Our board of directors administers our 2006 Plan. Our board of directors, however, may delegate this authority to a committee created and appointed by the board of directors to administer the 2006 Plan. Our board of directors or the authorized committee, referred to as the plan administrator, has the authority to construe, interpret, amend and suspend the 2006 Plan, as well as to determine the terms of an option or amend the terms of an option. However, no amendment may materially and adversely affect the rights under any outstanding option unless the holder consents to that amendment.

Eligibility. The 2006 Plan provides for the grant of stock awards to our employees, directors and consultants. Incentive stock options may be granted only to employees. Nonstatutory stock options and stock awards may be granted to employees, directors and consultants.

Stock Option Provisions Generally. In general, the exercise price of a stock option cannot be less than 100% of the fair market value of our common stock on the date of grant. However, an incentive stock option granted to

[Table of Contents](#)

a person who on the date of grant owns more than 10% of the voting power of all classes of our outstanding stock or any of our affiliates must have a term of no more than five years and an exercise price that is at least 110% of the fair market value on the date of grant.

Generally, an optionee may not transfer his or her stock option other than by will or by the laws of descent and distribution. Shares subject to options under the 2006 Plan generally vest and become exercisable in periodic installments. In general, the term of stock options granted under the 2006 Plan cannot exceed ten years. The aggregate fair market value, determined at the time of grant, of shares of our common stock with respect to which incentive stock options are exercisable for the first time by an optionee during any calendar year under all of our stock plans may not exceed \$100,000. Options or portions thereof that exceed such limit generally will be treated as nonstatutory stock options. Subject to capitalization adjustments, no more than 10,000,000 shares of common stock may be issued under the 2006 Plan pursuant to the exercise of incentive stock options.

Unless otherwise provided by an optionee's stock option agreement, if an optionee's service relationship with us, or any of our affiliates, ceases for any reason other than disability, death, or for cause, the optionee generally may exercise the vested portion of any options for a period of three months following the cessation of service. If an optionee's service relationship with us, or any of our affiliates, ceases due to disability or death, or an optionee dies within three months following cessation of service, the optionee or a beneficiary may generally exercise any vested options for a period of twelve months after such disability or death. In the event of a termination for cause, options generally terminate immediately upon the termination of the optionee's service. In no event may an option be exercised beyond the expiration of its term.

Rights to Acquire Restricted Stock. Rights to acquire restricted stock may be granted pursuant to restricted stock purchase agreements adopted under the 2006 Plan. The purchase price for restricted stock awards may be paid using cash, cancellation of indebtedness, promissory note, past services provided to us or our affiliates, or other legal consideration permitted by our board of directors or the authorized committee in its discretion. The purchase price of restricted stock awards cannot be less than 100% of the fair market value of our common stock on the date of grant or the date the purchase is consummated, except in the case of a person who on the date of grant owns or is deemed to own more than 10% of the total combined voting power of all classes of our outstanding stock or any of our affiliates, in which case the purchase price must be at least 110% of the fair market value on the date of grant or the date the purchase is consummated. Shares of common stock acquired under restricted stock awards rights may, but need not, be subject to a share repurchase option in our favor in accordance with a vesting schedule to be determined by our board, in which case, if a participant's service relationship with us terminates, we may repurchase or otherwise reacquire any or all of the shares of common stock subject to the restricted stock award that has not vested as of the date of termination. A holder of a restricted stock award may not transfer his or her stock award other than by will or by the laws of descent and distribution.

Changes to Capital Structure. In the event that there is a specified type of change in our capital structure, such as a stock split or recapitalization, appropriate adjustments will be made to the number of shares subject to the 2006 Plan and to the number of shares and price per share of all outstanding options and stock awards.

Corporate Transactions. In the event of certain specified significant corporate transactions involving us, such as our liquidation or dissolution, a merger or consolidation that results in a material change in the ownership of our company, the sale of substantially all of our assets, or the sale of at least a majority of our outstanding capital stock, the surviving or acquiring corporation may assume or substitute equivalent options or stock awards for the outstanding stock options and awards granted under the 2006 Plan. If, in the event of such a corporate transaction (and in the case of a merger, consolidation, or sale of substantially all of our assets, our stockholders after such event cease to hold at least 80% of the shares of our capital stock held by them prior to such event), the surviving or acquiring corporation elects not to assume or substitute equivalent options or stock awards for outstanding options or stock awards, then the vesting of outstanding options and awards under the 2006 Plan will accelerate, prior to the consummation of such corporate transaction, by one calendar month for each calendar month the optionee or holder of stock awards has been employed by us, up to a maximum of twelve months, in

addition to any other applicable vesting. Options or stock awards not exercised prior to the consummation of such corporate transaction shall expire on the occurrence of such corporate transaction, as the board of directors or authorized committee shall determine.

2011 Equity Incentive Plan

Our board of directors adopted the 2011 Equity Incentive Plan, or 2011 Incentive Plan, in June 2011 as a successor to the 2006 Plan. Subject to stockholder approval, we expect the 2011 Incentive Plan will become effective immediately upon the execution and delivery of the underwriting agreement for this offering. The 2011 Incentive Plan will terminate ten years after the effective date of this offering, unless sooner terminated by our board of directors. Our board of directors may amend or suspend the 2011 Incentive Plan at any time, although no such action may impair the rights under any then-outstanding award without the holder's consent.

Stock Awards. The 2011 Incentive Plan provides for the grant of incentive stock options, nonstatutory stock options, stock appreciation rights, restricted stock awards, restricted stock unit awards, performance-based stock awards, and other forms of equity compensation, or collectively, stock awards, all of which may be granted to employees, including officers, and to non-employee directors and consultants. Additionally, the 2011 Incentive Plan provides for the grant of performance cash awards. Incentive stock options may be granted only to employees. All other awards may be granted to employees, including officers, and to non-employee directors and consultants.

Share Reserve. Initially, the aggregate number of shares of our common stock that may be issued pursuant to stock awards under the 2011 Incentive Plan after the 2011 Incentive Plan becomes effective is 24,000,000 shares. Then, the number of shares of our common stock reserved for issuance under the 2011 Incentive Plan will automatically increase on January 1st each year, starting on January 1, 2013 and continuing through January 1, 2021, by 4.5% of the total number of shares of our common stock outstanding on December 31 of the preceding calendar year, or such lesser number of shares of common stock as determined by our board of directors. The maximum number of shares that may be issued pursuant to the exercise of incentive stock options under the 2011 Incentive Plan is 120,000,000 shares.

No person may be granted stock awards covering more than 2,000,000 shares of our common stock under our 2011 Incentive Plan during any calendar year pursuant to stock options, stock appreciation rights and other stock awards whose value is determined by reference to an increase over an exercise or strike price of at least 100% of the fair market value on the date the stock award is granted. Additionally, no person may be granted in a calendar year a performance stock award covering more than 1,000,000 shares or a performance cash award having a maximum value in excess of \$1,000,000. Such limitations are designed to help assure that any deductions to which we would otherwise be entitled with respect to such awards will not be subject to the \$1,000,000 limitation on the income tax deductibility of compensation paid to any covered executive officer imposed by Section 162(m) of the Code.

If a stock award granted under the 2011 Incentive Plan expires or otherwise terminates without being exercised in full, or is settled in cash, the expiration, termination or settlement shall not reduce (or otherwise offset) the number of shares of common stock that may be available for issuance under the 2011 Incentive Plan. In addition, the following types of shares under the 2011 Incentive Plan may become available for the grant of new stock awards under the 2011 Incentive Plan: (1) shares that are forfeited to or repurchased by us prior to becoming fully vested; (2) shares withheld to satisfy income or employment withholding taxes; or (3) shares used to pay the exercise price of an option. Shares issued under the 2011 Incentive Plan may be previously unissued shares or reacquired shares bought by us on the open market. As of the date hereof, no awards have been granted and no shares of our common stock have been issued under the 2011 Incentive Plan.

Administration. Our board of directors, or a duly authorized committee thereof, has the authority to administer the 2011 Incentive Plan. Our board of directors has delegated its authority to administer the 2011

[Table of Contents](#)

Incentive Plan to our compensation committee under the terms of the compensation committee's charter. Our board of directors may also delegate to one or more of our officers the authority to (1) designate employees (other than other officers) to be recipients of certain stock awards, and (2) determine the number of shares of common stock to be subject to such stock awards, provided that our board of directors must specify the total number of shares of common stock that may be subject to stock awards granted by such officer and that such officer may not grant a stock award to himself or herself. Subject to the terms of the 2011 Incentive Plan, our board of directors or the authorized committee or officer, referred to as the plan administrator, determines recipients, dates of grant, the numbers and types of stock awards to be granted and the terms and conditions of the stock awards, including the period of their exercisability and vesting schedule applicable to a stock award. Subject to the limitations set forth below, the plan administrator will also determine the exercise price, strike price or purchase price of awards granted and the types of consideration to be paid for the award.

The plan administrator has the authority to reduce the exercise price (or strike price) of any outstanding option or stock appreciation right, cancel and re-grant any outstanding option or stock appreciation right or take any other action that is treated as a repricing under U.S. generally accepted accounting principles, with the consent of any adversely affected participant.

Stock Options. Incentive and nonstatutory stock options are granted pursuant to stock option agreements adopted by the plan administrator. The plan administrator determines the exercise price for a stock option, within the terms and conditions of the 2011 Incentive Plan, provided that the exercise price of a stock option generally cannot be less than 100% of the fair market value of our common stock on the date of grant. Options granted under the 2011 Incentive Plan vest at the rate specified by the plan administrator.

The plan administrator determines the term of stock options granted under the 2011 Incentive Plan, up to a maximum of 10 years. Unless the terms of an optionee's stock option agreement provide otherwise, if an optionee's service relationship with us, or any of our affiliates, ceases for any reason other than disability, death or cause, the optionee may generally exercise any vested options for a period of three months following the cessation of service. The option term may be extended in the event that exercise of the option or sale of shares received upon exercise of the option following such a termination of service is prohibited by applicable securities laws or our insider trading policy. If an optionee's service relationship with us, or any of our affiliates, ceases due to disability or death, or an optionee dies within a certain period following cessation of service, the optionee or a beneficiary may generally exercise any vested options for a period of 12 months. In the event of a termination for cause, options generally terminate immediately upon the occurrence of the event giving rise to the right to terminate the individual for cause. In no event may an option be exercised beyond the expiration of its term.

Acceptable consideration for the purchase of common stock issued upon the exercise of a stock option will be determined by the plan administrator and may include (1) cash, check, bank draft or money order, (2) a broker-assisted cashless exercise, (3) the tender of shares of our common stock previously owned by the optionee, (4) a net exercise of the option if it is a nonstatutory stock option, and (5) other legal consideration approved by the plan administrator.

Unless the plan administrator provides otherwise, options generally are not transferable except by will, the laws of descent and distribution, or pursuant to a domestic relations order. An optionee may designate a beneficiary, however, who may exercise the option following the optionee's death.

Tax Limitations on Incentive Stock Options. The aggregate fair market value, determined at the time of grant, of our common stock with respect to incentive stock options that are exercisable for the first time by an optionee during any calendar year under all of our stock plans may not exceed \$100,000. Options or portions thereof that exceed such limit will generally be treated as nonstatutory stock options. No incentive stock option may be granted to any person who, at the time of the grant, owns or is deemed to own stock possessing more than 10% of our total combined voting power or that of any of our affiliates unless (1) the option exercise price is at least 110% of the fair market value of the stock subject to the option on the date of grant, and (2) the term of the incentive stock option does not exceed five years from the date of grant.

[Table of Contents](#)

Restricted Stock Awards. Restricted stock awards are granted pursuant to restricted stock award agreements adopted by the plan administrator. Restricted stock awards may be granted in consideration for (1) cash, check, bank draft or money order, (2) past services rendered to us or our affiliates, or (3) any other form of legal consideration (including future services) that may be acceptable to our board of directors and permissible under applicable law. Common stock acquired under a restricted stock award may, but need not, be subject to a share repurchase option in our favor in accordance with a vesting schedule to be determined by the plan administrator. Rights to acquire shares under a restricted stock award may be transferred only upon such terms and conditions as set by the plan administrator.

Restricted Stock Unit Awards. Restricted stock unit awards are granted pursuant to restricted stock unit award agreements adopted by the plan administrator. The plan administrator will determine the vesting terms of restricted stock unit awards. The plan administrator will determine the consideration to be paid, if any, by the participant upon delivery for each share subject to a restricted stock unit award, which may be paid in any form of legal consideration acceptable to the plan administrator. A restricted stock unit award may be settled by cash, delivery of stock, a combination of cash and stock as deemed appropriate by the plan administrator, or in any other form of consideration set forth in the restricted stock unit award agreement. Additionally, dividend equivalents may be credited in respect of shares covered by a restricted stock unit award. Except as otherwise provided in the applicable award agreement, restricted stock units that have not vested will be forfeited upon the participant's cessation of continuous service for any reason.

Stock Appreciation Rights. Stock appreciation units are granted pursuant to stock appreciation right agreements adopted by the plan administrator. The plan administrator determines the strike price for a stock appreciation right, which generally cannot be less than 100% of the fair market value of our common stock on the date of grant. Upon the exercise of a stock appreciation right, we will pay the participant an amount equal to the product of (1) the excess of the per share fair market value of our common stock on the date of exercise over the strike price, multiplied by (2) the number of shares of common stock with respect to which the stock appreciation right is exercised. A stock appreciation right granted under the 2011 Incentive Plan vests at the rate specified in the stock appreciation right agreement as determined by the plan administrator. The appreciation distribution with respect to a stock appreciation right may be paid in common stock, in cash, in any combination of the two or in any other form of consideration, as determined by our board of directors and specified in the stock appreciation right agreement.

The plan administrator determines the term of stock appreciation rights granted under the 2011 Incentive Plan, up to a maximum of ten years. Unless the terms of a participant's stock appreciation right agreement provides otherwise, if a participant's service relationship with us, or any of our affiliates, ceases for any reason other than cause, disability or death, the participant may generally exercise any vested stock appreciation right for a period of three months following the cessation of service. The stock appreciation right term may be further extended in the event that exercise of the stock appreciation right or the sale of shares received upon exercise of the stock appreciation right following such a termination of service is prohibited by applicable securities laws. If a participant's service relationship with us, or any of our affiliates, ceases due to disability or death, or a participant dies within a certain period following cessation of service, the participant or a beneficiary may generally exercise any vested stock appreciation right for a period of 12 months. In the event of a termination for cause, stock appreciation rights generally terminate immediately upon the occurrence of the event giving rise to the right to terminate the individual for cause. In no event may a stock appreciation right be exercised beyond the expiration of its term.

Performance Awards. The 2011 Incentive Plan permits the grant of performance-based stock and cash awards that may qualify as performance-based compensation not subject to the \$1,000,000 limitation on the income tax deductibility of compensation paid to a covered executive officer imposed by Section 162(m) of the Code. To help assure that the compensation attributable to performance-based awards will so qualify, our compensation committee can structure such awards so that stock or cash will be issued or paid pursuant to such award only after the achievement of certain pre-established performance goals during a designated performance period.

Table of Contents

The performance criteria used to establish performance goals for a performance plan may be based on one or more of the following: (1) earnings (including earnings per share and net earnings); (2) earnings before interest, taxes and depreciation; (3) earnings before interest, taxes, depreciation and amortization; (4) total stockholder return; (5) return on equity or average stockholder's equity; (6) return on assets, investment, or capital employed; (7) stock price; (8) margin (including gross margin); (9) income (before or after taxes); (10) operating income; (11) operating income after taxes; (12) pre-tax profit; (13) operating cash flow; (14) sales or revenue targets; (15) increases in revenue or product revenue; (16) expenses and cost reduction goals; (17) improvement in or attainment of working capital levels; (18) economic value added (or an equivalent metric); (19) market share; (20) cash flow; (21) cash flow per share; (22) share price performance; (23) debt reduction; (24) implementation or completion of projects or processes; (25) customer satisfaction; (26) stockholders' equity; (27) capital expenditures; (28) debt levels; (29) operating profit or net operating profit; (30) workforce diversity; (31) growth of net income or operating income; (32) billings; and (33) to the extent that an award is not intended to comply with Section 162(m) of the Code, other measures of performance selected by our board of directors.

The performance goals may be based on a company-wide basis, with respect to one or more business units, divisions, affiliates, or business segments, and in either absolute terms or relative to the performance of one or more comparable companies or the performance of one or more relevant indices. Unless specified otherwise (1) in the award agreement at the time the award is granted or (2) in such other document setting forth the performance goals at the time the goals are established, the plan administrator will appropriately make adjustments in the method of calculating the attainment of performance goals as follows: (1) to exclude restructuring and/or other nonrecurring charges; (2) to exclude exchange rate effects, as applicable, for non-U.S. dollar denominated goals; (3) to exclude the effects of changes to U.S. generally accepted accounting principles; (4) to exclude the effects of any statutory adjustments to corporate tax rates; and (5) to exclude the effects of any "extraordinary items" as determined under generally accepted accounting principles. In addition, the plan administrator retains the discretion to reduce or eliminate the compensation or economic benefit due upon attainment of the goals and to define the manner of calculating the performance criteria it selects to use for a performance period. The performance goals may differ from participant to participant and from award to award.

Other Stock Awards. The plan administrator may grant other awards based in whole or in part by reference to our common stock. The plan administrator will set the number of shares under the stock award and all other terms and conditions of such awards.

Changes to Capital Structure. In the event that there is a specified type of change in our capital structure, such as a stock split or recapitalization, the plan administrator shall appropriately and proportionately adjust: (a) the class(es) and maximum number of shares reserved for issuance under the 2011 Incentive Plan, (b) the class(es) and maximum number of shares that may be issued upon the exercise of incentive stock options, (c) the class(es) and maximum number of shares subject to stock awards that can be granted in a calendar year (as established under the 2011 Incentive Plan pursuant to Section 162(m) of the Code) and (d) the class(es) and number of shares and price per share of stock subject to outstanding stock awards.

Corporate Transactions. In the event of certain specified significant corporate transactions, unless otherwise provided in the instrument evidencing the stock award or any other written agreement between us or any affiliate and the holder of the stock award, the plan administrator has the discretion to take any of the following actions with respect to stock awards:

- arrange for the assumption, continuation or substitution of a stock award by a surviving or acquiring entity or parent company;
- arrange for the assignment of any reacquisition or repurchase rights held by us to the surviving or acquiring entity or parent company;
- accelerate the vesting of the stock award and provide for its termination prior to the effective time of the corporate transaction;

Table of Contents

- arrange for the lapse of any reacquisition or repurchase right held by us;
- cancel or arrange for the cancellation of the stock award in exchange for such cash consideration, if any, as our board of directors may deem appropriate; or
- make a payment equal to the excess of (a) the value of the property the participant would have received upon exercise of the stock award over (b) the exercise price otherwise payable in connection with the stock award.

Our board of directors is not obligated to treat all stock awards, even those that are of the same type, in the same manner.

Change in Control. The plan administrator may provide, in an individual award agreement or in any other written agreement between a participant and us, that the stock award will be subject to additional acceleration of vesting and exercisability in the event of a certain specified change in control. However, in the absence of such a provision, no such acceleration of the stock award will occur.

2011 Employee Stock Purchase Plan

Our board of directors adopted the 2011 Employee Stock Purchase Plan, or ESPP, in June 2011. Subject to stockholder approval, we expect the ESPP will become effective immediately upon the execution and delivery of the underwriting agreement for this offering.

Share Reserve. The ESPP initially authorizes the issuance of 6,080,000 shares of our common stock pursuant to purchase rights granted to our employees or to employees of any of our designated affiliates. The number of shares of our common stock reserved for issuance will automatically increase on January 1 each year, starting January 1, 2013 and continuing through January 1, 2021, in an amount equal to the lower of (1) 1% of the total number of shares of our common stock outstanding on December 31 of the preceding calendar year, (2) 3,000,000 shares of our common stock or (3) a number of shares of common stock as determined by our board of directors. If a purchase right granted under the ESPP terminates without having been exercised, the shares of our common stock not purchased under such purchase right will be available for issuance under the ESPP.

Administration. Our board of directors, or a duly authorized committee thereof, has the authority to administer the ESPP. Our board of directors has delegated its authority to administer the ESPP to our compensation committee. Our board of directors or the authorized committee is referred to as the plan administrator.

Purchase Rights. The ESPP is implemented through a series of offerings of purchase rights to eligible employees. Purchase rights are generally not transferable. Under the ESPP, we may specify offerings with a duration of not more than 27 months, and may specify one or more shorter purchase periods within each offering. Each offering will have one or more purchase dates on which shares of our common stock will be purchased for the employees who are participating in the offering. An offering may be terminated early under certain circumstances such as a material change in control of Enphase. The plan administrator has the discretion to structure an offering so that if the fair market value of the shares of our common stock on the first day of a new purchase period within such offering is less than or equal to the fair market value of the shares of our common stock on the first day of the offering, then (a) that offering shall terminate immediately, and (b) the participants in such terminated offering shall be automatically enrolled in a new offering beginning on the first day of such new purchase period.

Payroll Deductions. Generally, all regular employees, including executive officers, employed by us or by any of our designated affiliates, may participate in the ESPP and may contribute, normally through payroll deductions, up to 15% of their earnings toward the purchase of our common stock under the ESPP. Unless

[Table of Contents](#)

otherwise determined by the plan administrator, common stock will be purchased for participating employees at a price per share equal to the lower of (a) 85% of the fair market value of a share of our common stock on the first date of an offering, or (b) 85% of the fair market value of a share of our common stock on the date of purchase.

Limitations. Employees may have to satisfy one or more of the following service requirements before participating in the ESPP, as determined by the plan administrator: (a) customary employment with us or one of our affiliates for more than 20 hours per week and more than five months per calendar year or (b) continuous employment with us or one of our affiliates for a minimum period of time prior to the first date of an offering, provided that such minimum period may not to exceed two years. No employee may purchase shares under the ESPP at a rate in excess of \$25,000 worth of our common stock, based on the fair market value per share of our common stock at the beginning of an offering, for each calendar year in which such purchase right is outstanding. Finally, no employee will be eligible for the grant of any purchase rights under the ESPP if, immediately after such rights are granted, such employee owns our stock possessing five percent or more of the total combined voting power or value of all classes of our outstanding capital stock.

Changes to Capital Structure. In the event that there is a specified type of change in our capital structure such as a stock split or recapitalization, appropriate adjustments will be made to (a) the class(es) and maximum number of shares reserved under the ESPP, (b) the class(es) and maximum number of shares by which the share reserve may increase automatically each year, (c) the class(es) and number of shares subject to, and purchase price applicable to, all outstanding purchase rights, and (d) any limits on the class(es) and number of shares that may be purchased in an ongoing offering.

Corporate Transactions. In the event of certain significant corporate transactions, such as an acquisition of the company that results in a material change in the ownership of the company, any then-outstanding purchase rights under the ESPP may be assumed, continued or substituted for by any surviving or acquiring entity or its parent company, provided that the rights of any participant under any such assumption, continuation or substitution will not be impaired. If the surviving or acquiring entity or its parent company elects not to assume, continue or substitute for such purchase rights, then the participants' accumulated contributions will be used to purchase shares of our common stock within 10 business days prior to such corporate transaction, and such purchase rights will terminate immediately thereafter.

Plan Amendments. The plan administrator has the authority to amend, suspend or terminate the ESPP, provided any such action will not be taken without the consent of an adversely affected participant except as necessary to comply with any laws, listing requirements or governmental regulations or to maintain favorable tax, listing or regulatory treatment. We will obtain stockholder approval of any amendment to our ESPP as required by applicable law.

401(k) Plan

We offer a 401(k) plan to all employees who meet specified eligibility requirements. Eligible employees may contribute up to the lesser of 100% of their eligible compensation or the maximum amount as permitted each calendar year under the Code. We make a nonelective employer contribution each year equal to 3% of each participant's eligible compensation during the applicable plan year.

Indemnification of Directors and Officers and Limitation of Liability

Our certificate of incorporation includes a provision that eliminates, to the fullest extent permitted by law, the personal liability of a director for monetary damages resulting from breach of his fiduciary duty as a director.

Our bylaws, as in effect upon completion of this offering, provide that:

- we are required to indemnify our directors and officers to the fullest extent permitted by the Delaware General Corporation Law, subject to very limited exceptions;

[Table of Contents](#)

- we may indemnify our other employees and agents as provided in indemnification contracts entered into between us and our employees and agents;
- we are required to advance expenses, as incurred, to our directors and officers in connection with a legal proceeding to the fullest extent permitted by the Delaware General Corporation Law, subject to very limited exceptions; and
- the rights conferred in the bylaws are not exclusive.

In addition to the indemnification required in our certificate of incorporation and bylaws, we have entered into indemnity agreements with each of our current directors and officers. These agreements provide for the indemnification of our directors and officers for all reasonable expenses and liabilities incurred in connection with any action or proceeding brought against them by reason of the fact that they are or were our agents. We have also obtained directors' and officers' insurance to cover our directors, officers and some of our employees for liabilities, including liabilities under securities laws. We believe that these indemnification provisions and agreements and this insurance are necessary to attract and retain qualified directors and officers.

A stockholder's investment may be adversely affected to the extent we pay the costs of settlement and damage awards against directors and officers as required by these indemnification provisions. At present, there is no pending litigation or proceeding involving any of our directors, officers or employees regarding which indemnification by us is sought, nor are we aware of any threatened litigation that may result in claims for indemnification.

Compensation Risk Assessment

In connection with this offering, our board of directors expects to review the potential risks associated with the structure and design of our various compensation plans, including a comprehensive review of the material compensation plans and programs for all employees. Our material plans and programs operate within our larger corporate governance and review structure that serves and supports risk mitigation.

CERTAIN RELATIONSHIPS AND RELATED PARTY TRANSACTIONS

The following is a summary of transactions since January 1, 2008 to which we were or are a party in which the amount involved exceeded or exceeds \$120,000 and in which any of our directors, executive officers, holders of more than 5% of any class of our voting securities or any member of the immediate family of any of the foregoing persons, had or will have a direct or indirect material interest, other than compensation arrangements with directors and executive officers, which are described where required under the “Executive Compensation” and “Management—Non-Employee Director Compensation” sections of this prospectus.

Private Placement Financings

Preferred Stock Financings

The following table summarizes purchases of our Series B preferred stock, Series C preferred stock, Series D Preferred Stock and Series E preferred stock since January 1, 2008 by holders of more than 5% of our capital stock and their affiliated entities and by certain of our directors and executive officers.

Name	Series B Preferred Stock	Aggregate Purchase Price of Series B Preferred Stock	Series C Preferred Stock	Aggregate Purchase Price of Series C Preferred Stock	Series D Preferred Stock	Aggregate Purchase Price of Series D Preferred Stock	Series E Preferred Stock	Aggregate Purchase Price of Series E Preferred Stock
Applied Ventures, LLC ⁽¹⁾	1,132,075	\$ 750,000	1,076,905	\$ 1,383,500	7,744,680	\$ 1,820,000	2,250,520	\$ 1,530,354
Funds affiliated with Third Point LLC ⁽²⁾			3,846,812	4,941,999	16,513,442	3,703,260	6,876,823	4,676,240
RockPort Capital Partners II, L.P. ⁽³⁾			5,837,939	7,500,000	21,665,232	5,002,630	6,490,751	4,413,711
Madrone Partners, L.P. ⁽⁴⁾					29,787,234	7,000,000	5,320,085	3,617,658
Funds affiliated with Bay Partners ⁽⁵⁾					4,255,320	1,000,000	8,823,530	6,000,000
KPCB Holdings, Inc., as nominee ⁽⁶⁾							18,382,352	12,499,999
Robert Schwartz ⁽⁷⁾			23,352	30,000	212,766	50,000	32,352	21,999
Paul B. Nahi ⁽⁸⁾					212,766	50,000		
Martin Fornage ⁽⁹⁾					425,532	100,000	14,706	10,000
Raghuveer R. Belur ⁽¹⁰⁾					212,766	50,000	14,706	10,000
Approximate Price Per Share	\$ 0.6625		\$ 1.2847		\$ 0.2350		\$ 0.68	
Dates of Purchase	1/14/2008		4/16/2008		4/24/2009		3/15/2010; 4/5/2010 5/21/2010	

- (1) These shares are held by Applied Ventures, LLC, and include Series E preferred stock purchased on March 15, 2010.
- (2) Includes 2,546,512 shares of Series C preferred stock held by Third Point Offshore Master Fund L.P., 110,400 shares of Series C preferred stock held by Third Point Partners L.P., 705,500 shares of Series C preferred stock held by Third Point Partners Qualified L.P. and 484,400 shares of Series C preferred stock held by Third Point Ultra Master Fund L.P. Includes 10,761,163 shares of Series D preferred stock held by Third Point Offshore Master Fund L.P., 1,538,009 shares of Series D preferred stock held by Third Point Partners L.P., 2,943,443 shares of Series D preferred stock held by Third Point Partners Qualified L.P. and 1,270,827 shares of Series D preferred stock held by Third Point Ultra Master Fund L.P. Includes 4,637,526 shares of Series E preferred stock held by Third Point Offshore Master Fund L.P., 813,858 shares of Series E preferred stock held by Third Point Partners L.P., 781,471 shares of Series E preferred stock held by Third Point Partners Qualified L.P. and 643,968 shares of Series E preferred stock held by Third Point Ultra Master Fund L.P., purchased on March 15, 2010. Robert Schwartz, one of our directors, is Managing Partner of Third Point Ventures, but does not have any voting or dispositive power with respect to the shares of stock held by the funds affiliated with Third Point Ventures. Mr. Schwartz disclaims beneficial ownership of these shares except to the extent of his pecuniary interest therein.
- (3) These shares are held by RockPort Capital Partners II, L.P., and include Series E preferred stock purchased on March 15, 2010. Stoddard M. Wilson, one of our directors, is a General Partner of RockPort Capital Partners, and as such may be deemed to share voting and dispositive power with respect to all shares of stock held by RockPort Capital Partners II, L.P. Mr. Wilson disclaims beneficial ownership of such shares except to the extent of his pecuniary interest therein.
- (4) These shares are held by Madrone Partners, L.P., and include Series E preferred stock purchased on March 15, 2010. Jameson J. McJunkin is one of our directors and is a Managing Member of Madrone Capital Partners, and as such may be deemed to share voting and dispositive power with respect to all shares of stock held by Madrone Partners, L.P. Mr. McJunkin disclaims beneficial ownership of such securities except to the extent of his pecuniary interest therein.

Table of Contents

- (5) Includes 4,234,044 shares of Series D preferred stock held by Bay Partners XI, L.P. and 21,276 shares of Series D preferred stock held by Bay Partners XI Parallel Fund, L.P. Includes 8,779,412 shares of Series E preferred stock held by Bay Partners XI, L.P. and 44,118 shares of Series E preferred stock held by Bay Partners XI Parallel Fund, L.P., purchased on March 15, 2010. Neal Dempsey is one of our directors and is a Managing Member with Bay Partners, and as such may be deemed to share voting and dispositive power with respect to all shares of stock held by funds affiliated with Bay Partners. Mr. Dempsey disclaims beneficial ownership of such securities except to the extent of his pecuniary interest therein.
- (6) Includes 17,523,896 shares of Series E preferred stock held by KPCB Green Growth Fund, LLC, 12,020 shares of Series E preferred stock held directly by Benjamin Kortlang and 846,436 shares of Series E preferred stock in the aggregate beneficially owned by individuals and entities affiliated with KPCB Green Growth Fund, LLC, purchased on May 21, 2010. The managing member for KPCB Green Growth Fund, LLC is KPCB GGF Associates, LLC. Benjamin Kortlang is one of our directors and is a member of the KPCB Green Growth Associates, LLC. The shares held by KPCB Green Growth Fund, LLC, Benjamin Kortlang and affiliated individuals and entities are held for convenience in the name of "KPCB Holdings, Inc. as nominee," for the accounts of the individual managers, Benjamin Kortlang and other individuals and entities that each exercise their own voting and dispositive control over the shares for their own accounts. KPCB Holdings, Inc. has no voting, dispositive or pecuniary interest in any such shares.
- (7) These shares are held by Mr. Schwartz, a member of our board of directors and Managing Partner of Third Point Ventures, and include Series E preferred stock purchased on April 5, 2010.
- (8) These shares are held by Mr. Nahi, our President, Chief Executive Officer and a member of our board of directors.
- (9) These shares are held by Mr. Fornage, our Chief Technology Officer, and include Series E preferred stock purchased on April 5, 2010.
- (10) These shares are held by Mr. Belur, our Vice President of Products and a member of our board of directors, and include Series E preferred stock purchased on April 5, 2010.

2009 Bridge Loan Financing

On March 31, 2009, we sold secured convertible promissory notes to purchase shares of our equity securities to five of our existing investors for an aggregate purchase price of \$1.5 million. The notes accrued interest at a rate of 8% per year and were due and payable by December 31, 2009. On April 24, 2009, the notes, and accrued interest of \$7,890.42, were converted into 7,548,886 shares of Series D convertible preferred stock, representing a purchase price discount of approximately 15% to such investors.

The following table summarizes the participation in the 2009 bridge financing by holders of more than 5% of our capital stock and their affiliated entities:

Name	Aggregate Principal Amount	Aggregate Shares of Series D Preferred Stock Issued Upon Conversion of 2009 Convertible Promissory Notes
Funds affiliated with Third Point LLC ⁽¹⁾	\$ 1,000,000	5,032,590
RockPort Capital Partners II, L.P. ⁽²⁾	500,000	2,516,296
(1)	Consists of: (a) 3,268,049 shares of Series D preferred stock issued to Third Point Offshore Master Fund L.P. upon the conversion of a principal amount of \$649,377 and \$3,415.90 in interest; (b) 470,748 shares of Series D preferred stock issued to Third Point Partners L.P. upon the conversion of a principal amount of \$93,540 and \$492.05 in interest; (c) 908,362 shares of Series D preferred stock issued to Third Point Partners Qualified L.P. upon the conversion of a principal amount of \$180,496 and \$949.46 in interest; and (d) 385,431 shares of Series D preferred stock issued to Third Point Ultra Master Fund L.P. upon the conversion of a principal amount of \$76,587 and \$402.87 in interest. Robert Schwartz, a member of our board of directors, is Managing Partner of Third Point Ventures, but does not have any voting or dispositive power with respect to the shares of stock held by the funds affiliated with Third Point Ventures. Mr. Schwartz disclaims beneficial ownership of these shares except to the extent of his pecuniary interest therein.	
(2)	Consists of 2,516,296 shares of Series D preferred stock issued to RockPort Capital Partners II, L.P. upon the conversion of a principal amount of \$500,000 and \$2,630.14 in interest. Stoddard M. Wilson, a member of our board of directors, is a General Partner of RockPort Capital Partners, and as such may be deemed to share voting and dispositive power with respect to all shares of stock held by RockPort Capital Partners II, L.P. Mr. Wilson disclaims beneficial ownership of such shares except to the extent of his pecuniary interest therein.	

Material Rights of Preferred Stock

The following is a brief description of the material rights of each series of our preferred stock issued to holders of more than 5% of our capital stock and their affiliated entities and by certain of our directors and executive officers. We anticipate that all outstanding shares of our preferred stock will automatically convert into

[Table of Contents](#)

shares of our common stock immediately prior to the closing of this offering pursuant to the terms of our certificate of incorporation. However, in the event that the requirements for such automatic conversion are not satisfied, we will solicit the requisite stockholder approval for the conversion of all outstanding shares of convertible preferred stock effective immediately prior to the closing of this offering.

Dividends—The holders of Series E, D, C, B and A convertible preferred stock are entitled to receive dividends, if, when and as declared by the board of directors, in an amount per share equal to the following (in order of right of payment):

	Dividend Per Share
Series E	\$ 0.0544
Series D	0.0188
Series C	0.103
Series B	0.053
Series A	0.025

No dividends have been declared on the Series E, D, C, B and A convertible preferred stock.

Conversion—The Series E, D, C, B and A convertible preferred stock will be automatically converted into common stock: (a) immediately prior to the closing of a firmly underwritten public offering pursuant to the Securities Act if aggregate gross proceeds to the company in such offering equal or exceed \$30,000,000 and the public offering price is not less than \$0.68 per share, or a “Qualified Public Offering”; and (b) upon our receipt of the written consent of the holders of (i) 60% of the Series E convertible preferred stock voting as a separate series, with respect to the conversion of all outstanding shares of Series E convertible preferred stock, (ii) a majority of the Series E convertible preferred stock voting as a separate series in connection with an initial public offering that is not a Qualified Public Offering, or (iii) a majority of the holders of the Series A, B, C and D convertible preferred stock voting together on an as-converted basis with respect to the conversion of all outstanding shares of Series A, B, C and D convertible preferred stock. Upon such conversion, each share of Series E, D, C, B and A convertible preferred stock will be converted into the number of shares of common stock as set forth below:

	Shares of Common Stock
Series E	1
Series D	1
Series C	2.514
Series B	1.898
Series A	1.226

Redemption—The Series E, D, C, B, and A convertible preferred stock are not redeemable.

Liquidation Rights—In the event of any liquidation, dissolution, or winding-up of Enphase, holders of Series E, D, C, B and A convertible preferred stock are entitled to receive, in addition to all declared but unpaid dividends, an amount per share equal to the following (in order of right of payment):

	Liquidation Preference Per Share
Series E	\$ 0.6800
Series D	0.5875
Series C	1.2847
Series B	0.6625
Series A	0.3200

[Table of Contents](#)

Voting—The holders of Series E, D, C, B and A convertible preferred stock are entitled to the number of votes equal to the number of shares of common stock into which the preferred stock is convertible, subject to certain limitations. The primary holders of Series E, D, C and B convertible preferred stock are entitled to elect the following number of members to our board of directors:

	<u>Number of Directors</u>
Series E	2
Series D	1
Series C	1
Series B	1

Protective Provisions—We cannot, without the consent of at least 60% of the then outstanding convertible preferred stock voting together as a single class on an as-converted basis, (i) change the rights, preferences, or privileges of the convertible preferred stock or any series of convertible preferred stock so as to materially and adversely affect the convertible preferred stock or any series of convertible preferred stock, (ii) increase or decrease the total number of authorized shares of convertible preferred stock, (iii) authorize or issue any shares of a new class or series of capital stock (or rights to acquire such new class or series of capital stock) having rights, preferences or privileges senior or equivalent to the Series E, D, C, B or A convertible preferred stock, (iv) cause or effect a change of control, liquidation, dissolution or winding up of Enphase, (v) redeem any shares of common stock except for certain permitted repurchases, (vi) increase or decrease the authorized number of directors on our board of directors unless approved unanimously by our board of directors, (vii) declare or pay any dividends or declare or make any other distribution, purchase, redemption or acquisition on any of our capital stock, except for certain permitted repurchases (viii) amend or alter our certificate of incorporation or bylaws, or (ix) consummate a public offering of the common stock of Enphase.

In addition, we cannot, without the consent of (i) at least 60% of the then outstanding Series E convertible preferred stock voting as a separate series (a) change the rights, preferences, or privileges of the Series E convertible preferred stock or (b) authorize or issue more than 75 million shares of Series E convertible preferred stock, (ii) at least 60% of the then outstanding shares of Series D convertible preferred stock voting as a separate series, change the rights, preferences, or privileges of the Series D convertible preferred stock, (iii) at least 60% of the then outstanding shares of Series C convertible preferred stock voting as a separate series, change the rights, preferences, or privileges of the Series C convertible preferred stock, and (iv) at least a majority of the then outstanding shares of Series B convertible preferred stock voting as a separate series, change the rights, preferences, or privileges of the Series B convertible preferred stock.

The rights of each series of our preferred stock, including those describe above, will terminate upon the conversion of all outstanding shares of convertible preferred stock immediately prior to the closing of this offering.

Convertible Debt Facility

In June 2011, we entered into a junior secured convertible loan facility, or Convertible Facility, with certain existing preferred stockholders that provides for up to \$50.0 million in borrowings. We borrowed \$12.5 million upon signing and may borrow up to an additional \$37.5 million prior to the earlier of (i) a subsequent equity financing of more than \$10.0 million or (ii) June 14, 2013, subject to the attainment of certain financial and operating conditions. The Convertible Facility bears an interest rate of 9%, with interest payable in kind at maturity, which is the earlier to occur of the closing of (i) our initial public offering, (ii) a change in control or (iii) June 14, 2014. The initial \$12.5 million loan and accrued interest is repayable in cash or convertible into common stock at the holders' option at a price of \$0.98 per share. Additional borrowings and accrued interest are repayable at the holders' option as follows: up to 50% convertible into common stock at a price of \$0.98 per share and the remainder in cash. The Convertible Facility is secured by substantially all of our assets except intellectual property and contains certain required covenants.

Table of Contents

In consideration for the lenders' commitment under this facility, we issued 1,890,609 shares of common stock at a purchase price of \$0.58 per share to fourteen of the lenders and issued to the remaining lenders warrants to purchase up to an aggregate amount of 695,586 shares of our common stock for an exercise price of \$0.58 per share. The warrants are immediately exercisable and will expire on June 14, 2016, subject to earlier termination upon an acquisition of us in which the consideration payable to holders of our common stock consists of cash and/or a class of securities that are registered under the Securities Exchange Act of 1934, as amended.

The following table summarizes the initial amounts invested, as well as the aggregate commitment amounts, of one of our directors and of holders of more than 5% of our capital stock and their affiliated entities with respect to the Convertible Facility.

<u>Name</u>	<u>Amount of Initial Note Investment</u>	<u>Aggregate Commitment Amount</u>	<u>Number of Common Shares Purchased</u>	<u>Number of Common Shares Underlying Warrant Issued</u>
Applied Ventures, LLC	\$ 610,525	\$ 2,442,100	—	126,315
Funds affiliated with Third Point LLC ⁽¹⁾	1,986,035	7,944,139	—	410,902
Madrone Partners, L.P. ⁽²⁾	1,536,451	6,145,803	317,886	317,886
Funds affiliated with Bay Partners ⁽³⁾	569,522	2,278,088	117,832	—
KPCB Holdings, Inc., as nominee ⁽⁴⁾	6,250,000	25,000,000	1,293,103	—
Robert Schwartz ⁽⁵⁾	12,500	50,000	—	2,586

- (1) Includes initial note investments of \$1,339,323.45 by Third Point Offshore Master Fund L.P., \$173,535.27 by Third Point Partners L.P., \$287,197.55 by Third Point Partners Qualified L.P. and \$185,978.55 by Third Point Ultra Master Fund L.P. Also includes warrants to purchase 277,101 shares of Common Stock issued to Third Point Offshore Master Fund L.P., 35,903 shares of Common Stock issued to Third Point Partners L.P., 59,420 shares of Common Stock issued to Third Point Partners Qualified L.P. and 38,478 shares of Common Stock issued to Third Point Ultra Master Fund L.P. Robert Schwartz, one of our directors, is Managing Partner of Third Point Ventures, but does not have any voting or dispositive power with respect to the shares of stock held by the funds affiliated with Third Point Ventures.
- (2) Jameson J. McJunkin is one of our directors and is a Managing Member of Madrone Capital Partners. Mr. McJunkin disclaims beneficial ownership of such securities except to the extent of his pecuniary interest therein.
- (3) Includes initial note investments of \$566,674.05 by Bay Partners XI, L.P. and \$2,848.00 by Bay Partners XI Parallel Fund, L.P. Also includes 117,242 shares of Common Stock purchased by Bay Partners XI, L.P. and 590 shares of Common Stock purchased by Bay Partners XI Parallel Fund, L.P. Neal Dempsey is one of our directors and is a Managing Member with Bay Partners. Mr. Dempsey disclaims beneficial ownership of such securities except to the extent of his pecuniary interest therein.
- (4) KPCB Holdings, Inc. serves as agent to the lenders with respect to the Convertible Facility. Includes initial note investments of \$5,958,125 by KPCB Green Growth Fund, LLC, \$4,087 by Benjamin Kortlang and \$287,788 by individuals and entities affiliated with KPCB Green Growth Fund, LLC. Also includes 1,232,715 shares of Common Stock issued to KPCB Green Growth Fund, LLC, 846 shares of Common Stock issued to Benjamin Kortlang and 59,542 shares of Common Stock issued to individuals and entities affiliated with KPCB Green Growth Fund, LLC. The managing member for KPCB Green Growth Fund, LLC is KPCB GGF Associates, LLC. Benjamin Kortlang is one of our directors and is a member of the KPCB Green Growth Associates, LLC. The securities held by KPCB Green Growth Fund, LLC, Benjamin Kortlang and affiliated individuals and entities are held for convenience in the name of "KPCB Holdings, Inc. as nominee," for the accounts of the individual managers, Benjamin Kortlang and other individuals and entities that each exercise their own voting and dispositive control over the securities for their own accounts. KPCB Holdings, Inc. has no voting, dispositive or pecuniary interest in any such securities.
- (5) Robert Schwartz, a member of our board of directors, is a Managing Partner of Third Point Ventures.

Loan to Officer

In connection with the hiring of Sanjeev Kumar, our Chief Financial Officer, we extended a loan to him in the principal amount of \$50,000, with an interest rate of 0.74% per annum, as an advance on his first-year performance bonus, which was evidenced by a full-recourse promissory note dated June 14, 2010. In November 2010, in light of Mr. Kumar's 2010 performance to date, including his substantial progress toward achieving his 2010 performance goals and the substantial progress made in improving our financial systems and controls, the outstanding principal and accrued interest under the loan was forgiven and the note was cancelled.

[Table of Contents](#)

Investors' Rights Agreement

In connection with our preferred stock financings, we entered into an investors' rights agreement with certain purchasers of our preferred stock, including the following principal stockholders, directors and executive officers:

Funds affiliated with Third Point LLC
RockPort Capital Partners II, L.P.
Madrone Partners, L.P.
KPCB Holdings, Inc., as nominee
Applied Ventures, LLC

Funds affiliated with Bay Partners
Paul B. Nahi
Raghuveer R. Belur
Martin Fornage
Robert Schwartz

Pursuant to this agreement, we granted such stockholders certain registration rights with respect to certain shares of our common stock held or issuable upon conversion of the shares of preferred stock held by them. For a description of these registration rights, see "Description of Capital Stock—Registration Rights." In addition to the registration rights, the investors' rights agreement provides for certain rights to receive financial information and rights of first refusal to participate in subsequent equity financings. The provisions and covenants contained in the investors' rights agreement, including with respect to information rights, rights of first refusal and various other affirmative covenants by the company, and other than those relating to registration rights and general contract provisions, will terminate upon the completion of this offering.

Voting Agreement

Pursuant to our 2010 voting agreement that we entered into with certain holders of our common stock and certain holders of our preferred stock:

- KPCB Holdings, Inc., as nominee, has the right to designate a director to our board of directors, which is currently Mr. Kortlang;
- funds affiliated with Bay Partners have the right to designate a director to our board of directors, which is currently Mr. Dempsey;
- funds affiliated with Madrone Capital Partners have the right to designate a director to our board of directors, which is currently Mr. McJunkin;
- funds affiliated with RockPort Capital Partners have the right to designate a director to our board of directors, which is currently Mr. Wilson;
- funds affiliated with Third Point LLC have the right to designate a director to our board of directors, which is currently Mr. Schwartz;
- Messrs. Nahi, Belur and Fornage have the right to designate, by a majority of the voting shares of common stock then held by them, two members of our board of directors, one of which shall be our then-current Chief Executive Officer, currently Mr. Nahi, and one of which is currently Mr. Belur; and
- the then-serving members of our board of directors have the right to nominate, by unanimous agreement, one director to our board of directors, which directorship is currently held by Mr. Gomo.

This voting agreement will terminate upon the completion of this offering and there will be no further contractual arrangements regarding the election of our directors.

Indemnification of Officers and Directors

Our amended and restated certificate of incorporation and bylaws provide that we shall indemnify each of our directors and officers to the fullest extent permitted by the Delaware General Corporation Law. Further, we have entered into indemnification agreements with each of our directors and officers. For further information, see the section entitled "Executive Compensation—Indemnification of Directors and Officers and Limitation of Liability."

Policies and Procedures for Related Party Transactions

We believe that we have executed all of the transactions set forth above on terms no less favorable to us than we could have obtained from unaffiliated third parties. It is our intention to ensure that all future transactions between us and our officers, directors and principal stockholders and their affiliates, are approved by the audit committee of our board of directors, and are on terms no less favorable to us than those that we could obtain from unaffiliated third parties.

Following this offering, all future related party transactions will be reviewed and approved by our audit committee. Pursuant to our written code of business conduct and ethics, the audit committee is responsible for approving, prior to our entry into any transaction involving related parties, all transactions in which we are a participant and in which any parties related to us has or will have a direct or indirect material interest.

In reviewing and approving these transactions, our audit committee will obtain, or will direct our management to obtain on its behalf, all information that the committee believes to be relevant and important to a review of the transaction prior to its approval. Following receipt of the necessary information, a discussion will be held of the relevant factors, if deemed to be necessary by the committee, prior to approval. If a discussion is not deemed to be necessary, approval may be given by written consent of the committee. No related party transaction will be entered into prior to the completion of these procedures.

Our audit committee will approve only those related party transactions that are determined to be in, or not inconsistent with, our best interests and those of our stockholders, taking into account all available facts and circumstances as the committee or the chairman determines in good faith to be necessary. No member of our audit committee will participate in any review, consideration or approval of any related party transaction with respect to which the member or any of his or her immediate family members is the related party.

Promoters

Raghuveer R. Belur and Martin Fornage, our co-founders and original stockholders, are deemed to be our “promoters” as these terms are defined under the federal securities laws. Messrs. Belur and Fornage have not received, and are not expected to receive, any compensation or consideration in their capacity as promoters.

PRINCIPAL STOCKHOLDERS

The following table sets forth information regarding beneficial ownership of our common stock as of June 30, 2011 by:

- each person or group of affiliated persons known by us to be the beneficial owner of more than 5% of our common stock;
- each of our named executive officers;
- each of our directors; and
- all executive officers and directors as a group.

The percentage ownership information shown in the table below is based upon 241,996,235 shares of common stock outstanding as of June 30, 2011, assuming the conversion of all outstanding preferred stock into 228,552,739 shares of our common stock. The percentage ownership information indicated in the following table reflects the sale by us of _____ shares of common stock in this offering.

Information with respect to beneficial ownership has been furnished by each director, officer or beneficial owner of more than 5% of our common stock. We have determined beneficial ownership in accordance with the rules of the SEC. These rules generally attribute beneficial ownership of shares to persons who possess sole or shared voting or investment power with respect to such shares. The information does not necessarily indicate beneficial ownership for any other purpose. Under these rules, the number of shares of common stock deemed outstanding includes shares issuable upon exercise of options, warrants or other convertible securities held by the respective person or group which may be exercised or converted within 60 days after June 30, 2011 and assumes the conversion of the principal and accrued interest outstanding under our junior convertible notes into shares of common stock immediately prior to the closing of this offering at a conversion price of \$0.98 per share, assuming the conversion occurs on September 30, 2011. These shares are deemed to be outstanding and beneficially owned by the person holding those options for the purpose of computing the percentage ownership of that person or entity, but they are not treated as outstanding for the purpose of computing the percentage ownership of any other person or entity. Unless otherwise indicated and subject to applicable community property laws, to our knowledge, each stockholder named in the following table possesses sole voting and investment power over the shares listed, except for those jointly owned with that person's spouse. Unless otherwise indicated below, the address of each person listed on the table is c/o Enphase Energy, Inc., 201 1st Street, Suite 100, Petaluma, California 94952, USA.

[Table of Contents](#)

Name and Address of Beneficial Owner 5% Stockholders:	Number of Shares Beneficially Owned		Percentage of Common Stock Beneficially Owned	
	Prior to Offering	After Offering	Prior to Offering	After Offering
Funds affiliated with Third Point LLC ⁽¹⁾	47,871,942	47,871,942	19.60%	
RockPort Capital Partners II, L.P. ⁽²⁾	42,832,562	42,832,562	17.70	
Madrone Partners, L.P. ⁽³⁾	37,034,966	37,034,966	15.20	
KPCB Holdings, Inc., as nominee ⁽⁴⁾	26,223,668	26,223,668	10.60	
Applied Ventures, LLC ⁽⁵⁾	15,617,187	15,617,187	6.40	
Funds affiliated with Bay Partners ⁽⁶⁾	13,793,377	13,793,377	5.70	
Named executive officers and directors:				
Paul B. Nahi ⁽⁷⁾	8,470,228	8,470,228	3.40	
Sanjeev Kumar ⁽⁸⁾	1,088,693	1,088,693	*	
Jeff Loebbaka ⁽⁹⁾	692,869	692,869	*	
Martin Fornage ⁽¹⁰⁾	9,231,186	9,231,186	3.80	
Raghuveer R. Belur ⁽¹¹⁾	7,545,352	7,545,352	3.10	
Neal Dempsey ⁽¹²⁾	13,793,377	13,793,377	5.70	
Steven J. Gomo ⁽¹³⁾	31,250	31,250	*	
Benjamin Kortlang ⁽¹⁴⁾	26,223,668	26,223,668	10.60	
Jameson J. McJunkin ⁽¹⁵⁾	37,034,966	37,034,966	15.20	
Chong Sup Park	—	—	—	
Robert Schwartz ⁽¹⁶⁾	48,334,693	48,334,693	19.80	
Stoddard M. Wilson ⁽¹⁷⁾	42,832,562	42,832,562	17.70	
All executive officers and directors as a group (15 persons) ⁽¹⁸⁾	196,345,428	196,345,428	72.50%	

- * Represents less than 1%
- (1) Consists of: (a)(i) 30,603,100 shares, (ii) 1,403,228 shares issuable upon the conversion of principal and interest outstanding under a convertible promissory note as of September 30, 2011, and (iii) warrants exercisable for 277,101 shares within 60 days of June 30, 2011, held by Third Point Offshore Master Fund L.P.; (b)(i) 3,965,225 shares, (ii) 181,815 shares issuable upon the conversion of principal and interest outstanding under a convertible promissory note as of September 30, 2011, and (iii) warrants exercisable for 35,903 shares within 60 days of June 30, 2011, held by Third Point Partners L.P.; (c)(i) 6,562,370 shares, (ii) 300,900 shares issuable upon the conversion of principal and interest outstanding under a convertible promissory note as of September 30, 2011, and (iii) warrants exercisable for 59,420 shares within 60 days of June 30, 2011, held by Third Point Partners Qualified L.P.; and (d)(i) 4,249,550 shares, (ii) 194,852 shares issuable upon the conversion of principal and interest outstanding under a convertible promissory note as of September 30, 2011, and (iii) warrants exercisable for 38,478 shares within 60 days of June 30, 2011, held by Third Point Ultra Master Fund L.P. Mr. Schwartz, a member of our board of directors, is a Managing Partner of Third Point Ventures, but does not have any voting or dispositive power with respect to the shares held by Third Point Ventures and its affiliated entities. Mr. Schwartz disclaims beneficial ownership of these shares except to the extent of his pecuniary interest therein. Third Point LLC, and Daniel S. Loeb in his capacity as the Chief Executive Officer of Third Point LLC, have voting and dispositive power over shares held by Third Point Offshore Master Fund L.P., Third Point Partners L.P., Third Point Partners Qualified L.P. and Third Point Ultra Master Fund L.P. Mr. Loeb disclaims beneficial ownership of these shares except to the extent of his pecuniary interest therein. The address of Third Point Partners is 390 Park Avenue, 18th Floor, New York, NY 10022.
- (2) Voting and dispositive powers are shared by the Managing Members of the General Partner of RockPort Capital Partners II, L.P. Its Managing Members are William James, David Prend, Alexander Ellis, III, Charles McDermott, Janet James and Stoddard Wilson, a member of our board of directors. Messrs. James, Prend, Ellis, McDermott and Wilson, and Ms. James, disclaim beneficial ownership of these shares except to the extent of their pecuniary interest therein. The address of RockPort Capital Partners is 160 Federal Street, 18th Floor, Boston, MA 02110-1700.
- (3) Includes 1,609,761 shares issuable upon the conversion of principal and interest outstanding under a convertible promissory note as of September 30, 2011. Greg Penner, Thomas Patterson and Jameson McJunkin, a member of our board of directors, share voting and dispositive power over shares held by Madrone Capital Partners; however, Messrs. Penner, Patterson and McJunkin disclaim beneficial ownership of these shares except to the extent of their pecuniary interest therein. The address of Madrone Partners is 3000 Sand Hill Road, Building 1, Suite 150, Menlo Park, CA 94025.

Table of Contents

- (4) Consists of: (a)(i) 18,756,611 shares and (ii) 6,242,411 shares issuable upon the conversion of principal and interest outstanding under a convertible promissory note as of September 30, 2011, held by KPCB Green Growth Fund, LLC; (b)(i) 12,868 shares and (ii) 4,283 shares issuable upon the conversion of principal and interest outstanding under a convertible promissory note as of September 30, 2011, held by Benjamin Kortlang, a member of our board of directors; and (c)(i) 905,976 shares and (ii) 301,519 shares issuable upon the conversion of principal and interest outstanding under a convertible promissory note as of September 30, 2011, in the aggregate beneficially owned by individuals and entities affiliated with KPCB Green Growth Fund, LLC. The managing member for KPCB Green Growth Fund, LLC is KPCB GGF Associates, LLC. Brook H. Byers, L. John Doerr, Joseph Lacob, Raymond J. Lane and Theodore E. Schlein, the Managing Directors of KPCB GGF Associates, LLC, and Ben Kortlang, a member of KPCB GGF Associates, LLC, exercise shared voting and dispositive control over the shares directly held by KPCB Green Growth Fund, LLC. The shares held by KPCB Green Growth Fund, LLC, Benjamin Kortlang and affiliated individuals and entities are held for convenience in the name of "KPCB Holdings, Inc. as nominee," for the accounts of the individual managers, Benjamin Kortlang and other individuals and entities that each exercise their own voting and dispositive control over the shares for their own accounts. KPCB Holdings, Inc. has no voting, dispositive or pecuniary interest in any such shares. The address of KPCB Green Growth Fund, LLC is 2750 Sand Hill Road, Menlo Park, CA 94025.
- (5) Includes: (a) 639,655 shares issuable upon the conversion of principal and interest outstanding under a convertible promissory note as of September 30, 2011, and (b) warrants exercisable for 126,315 shares within 60 days of June 30, 2011. J. Christopher Moran, in his capacity as General Manager of Applied Ventures, LLC, has sole voting and dispositive power over shares held by Applied Ventures, LLC. J. Christopher Moran, Dr. Omkaran Nalamasu, Dr. Mark R. Pinto and Larry Sparks, in their capacity as members of the Venture Investment Committee of Applied Materials, Inc., have shared voting and dispositive power over shares held by Applied Ventures, LLC; however, Messrs. Moran and Sparks, and Drs. Nalamasu and Pinto disclaim beneficial ownership of these shares except to the extent of their pecuniary interest therein. The address of Applied Ventures, LLC is 3050 Bowers Avenue, Santa Clara, CA 95054.
- (6) Consists of: (a)(i) 65,984 shares and (ii) 2,983 shares issuable upon the conversion of principal and interest outstanding under a convertible promissory note as of September 30, 2011, held by Bay Partners XI Parallel Fund, L.P.; and (b)(i) 13,130,698 shares and (ii) 593,712 shares issuable upon the conversion of principal and interest outstanding under a convertible promissory note as of September 30, 2011, held by Bay Partners XI, L.P. Stuart G. Phillips and Neal Dempsey, a member of our board of directors, are Managers of Bay Management Company XI, LLC and share voting and dispositive power over shares held by Bay Partners XI Parallel Fund, L.P. and Bay Partners XI, L.P. Messrs. Phillips and Dempsey disclaim beneficial ownership of these shares except to the extent of their pecuniary interest therein. The address of Bay Partners is 490 South California Avenue, Suite 200, Palo Alto, CA 94306.
- (7) Includes: (a) 250,000 shares of common stock held by Paul B. Nahi and Sheila B. Nahi, as Trustees of the Kayla Nahi Trust u/a/d December 21, 2009; (b) 250,000 shares of common stock held by Paul B. Nahi and Sheila B. Nahi, as Trustees of the Skylar Lisle Nahi Trust u/a/d December 21, 2009; and (c) stock options for 7,015,462 shares of our common stock exercisable within 60 days of June 30, 2011.
- (8) Consists solely of stock options to purchase 1,088,693 shares of our common stock exercisable within 60 days of June 30, 2011.
- (9) Consists solely of stock options to purchase 692,869 shares of our common stock exercisable within 60 days of June 30, 2011.
- (10) Includes: (a) 1,000,000 shares held by The Martin Forage Grantor Retained Annuity Trust; and (b) stock options to purchase 4,118,713 shares of our common stock exercisable within 60 days of June 30, 2011.
- (11) Includes: (a) 2,500,000 shares held by The Raghuvver Belur Grantor Retained Annuity Trust; and (b) stock options to purchase 4,074,294 shares of our common stock exercisable within 60 days of June 30, 2011.
- (12) Consists solely of the shares described in Note (6) above. Mr. Dempsey disclaims beneficial ownership of these shares, except to the extent of his pecuniary interest therein.
- (13) Consists solely of stock options to purchase 31,250 shares of our common stock exercisable within 60 days of June 30, 2011.
- (14) Consists solely of the shares described in Note (4) above. Mr. Kortlang disclaims beneficial ownership of these shares, except to the extent of his pecuniary interest therein.
- (15) Consists solely of the shares described in Note (3) above. Mr. McJunkin disclaims beneficial ownership of these shares, except to the extent of his pecuniary interest therein.
- (16) Includes: (a) the shares described in Note (1) above, which Mr. Schwartz disclaims beneficial ownership of, except to the extent of his pecuniary interest therein; (b) 13,096 shares issuable upon the conversion of principal and interest outstanding under a convertible promissory note as of September 30, 2011; and (c) warrants to purchase 2,586 shares within 60 days of June 30, 2011.
- (17) Consists solely of the shares described in Note (2) above. Mr. Wilson disclaims beneficial ownership of these shares, except to the extent of his pecuniary interest therein.
- (18) Includes: (a) 156,957,218 shares; (b) 10,848,560 shares issuable upon the conversion of principal and interest outstanding under convertible promissory notes as of September 30, 2011; and (c) warrants exercisable for 413,488 shares within 60 days of June 30, 2011, held by entities affiliated with certain of our directors; and (b) 28,094,912 shares beneficially owned by our executive officers, of which stock options for 17,510,615 shares of common stock are exercisable within 60 days of June 30, 2011.

DESCRIPTION OF CAPITAL STOCK

Upon consummation of this offering, our authorized capital stock will consist of _____ shares of common stock, \$0.0001 par value per share, and _____ shares of preferred stock, \$0.0001 par value per share. A description of the material terms and provisions of our amended and restated certificate of incorporation and amended and restated bylaws affecting the rights of holders of our capital stock is set forth below. The description is intended as a summary, and is qualified in its entirety by reference to the form of our amended and restated certificate of incorporation and the form of our amended and restated bylaws to be adopted prior to the completion of this offering and filed with the registration statement of which this prospectus is a part.

As of June 30, 2011, and after giving effect to the automatic conversion of all outstanding shares of our preferred stock into 228,552,739 shares of our common stock, there were outstanding:

- 241,996,235 shares of common stock held by 110 stockholders;
- 53,885,595 shares of common stock issuable upon exercise of outstanding stock options; and
- 2,747,165 shares of common stock issuable upon exercise of outstanding warrants, assuming the automatic conversion of outstanding warrants to purchase shares of our convertible preferred stock into warrants to purchase our common stock immediately prior to the completion of this offering.

Common Stock

Dividend Rights. Subject to preferences that may apply to shares of preferred stock outstanding at the time, the holders of outstanding shares of our common stock are entitled to receive dividends out of funds legally available if our board of directors, in its discretion, determines to issue dividends and then only at the times and in the amounts that our board of directors may determine.

Voting Rights. Each holder of common stock is entitled to one vote for each share of common stock held on all matters submitted to a vote of stockholders. Our certificate of incorporation does not provide for the right of stockholders to cumulate votes for the election of directors. Our certificate of incorporation effective upon completion of this offering establishes a classified board of directors, to be divided into three classes with staggered three-year terms. Only one class of directors will be elected at each annual meeting of our stockholders, with the other classes continuing for the remainder of their respective three-year terms.

No Preemptive or Similar Rights. Our common stock is not entitled to preemptive rights and is not subject to conversion, redemption or sinking fund provisions. The rights, preferences and privileges of the holders of our common stock are subject to, and may be adversely affected by, the rights of the holders of any series of our preferred stock that we may designate and issue in the future.

Right to Receive Liquidation Distributions. Upon our dissolution, liquidation or winding-up, the assets legally available for distribution to our stockholders are distributable ratably among the holders of our common stock, subject to prior satisfaction of all outstanding debt and liabilities and the preferential rights and payment of liquidation preferences, if any, on any outstanding shares of preferred stock.

Fully Paid and Nonassessable. All of our outstanding shares of common stock are, and the shares of common stock to be issued in this offering will be, fully paid and nonassessable.

Preferred Stock

Upon the completion of this offering, each outstanding share of preferred stock will be converted into common stock.

[Table of Contents](#)

Each share of Series E, D, C, B and A convertible preferred stock is convertible at the option of the holder into the number of shares of common stock which results from dividing the original issue price for such series of convertible preferred stock by the conversion price for such series of convertible preferred stock, subject to certain adjustments, as set forth below:

	<u>Original Issue Price</u>	<u>Conversion Price</u>	<u>Shares of Common Stock</u>
Series E	\$ 0.680	\$ 0.680	1
Series D	0.235	0.235	1
Series C	1.2847	0.511	2.514
Series B	0.6625	0.349	1.898
Series A	0.3200	0.261	1.226

The Series E, D, C, B and A convertible preferred stock will be automatically converted into common stock: (a) immediately prior to the closing of a firmly underwritten public offering pursuant to the Securities Act if aggregate gross proceeds to the company in such offering equal or exceed \$30,000,000 and the public offering price is not less than \$0.68 per share, or a “Qualified Public Offering”; and (b) upon our receipt of the written consent of the holders of (i) 60% of the Series E convertible preferred stock voting as a separate series, with respect to the conversion of all outstanding shares of Series E convertible preferred stock, (ii) a majority of the Series E convertible preferred stock voting as a separate series in connection with an initial public offering that is not a Qualified Public Offering, or (iii) a majority of the holders of the Series A, B, C and D convertible preferred stock voting together on an as-converted basis with respect to the conversion of all outstanding shares of Series A, B, C and D convertible preferred stock.

Following this offering, we will be authorized, subject to limitations prescribed by Delaware law, to issue preferred stock in one or more series, to establish from time to time the number of shares to be included in each series and to fix the designation, powers, preferences and rights of the shares of each series and any of its qualifications, limitations or restrictions. Our board of directors can also increase or decrease the number of shares of any series, but not below the number of shares of that series then outstanding, without any further vote or action by our stockholders. Our board of directors may authorize the issuance of preferred stock with voting or conversion rights that could adversely affect the voting power or other rights of the holders of the common stock. The issuance of preferred stock, while providing flexibility in connection with possible acquisitions and other corporate purposes, could, among other things, have the effect of delaying, deferring, discouraging or preventing a change in control of our company and may adversely affect the market price of our common stock and the voting and other rights of the holders of common stock. We have no current plan to issue any shares of preferred stock.

Warrants

As of June 30, 2011, 100,000 shares of our common stock were issuable upon exercise of an outstanding warrant to purchase common stock with an exercise price of \$0.50 per share. This warrant was issued in connection with the execution of a supply and services agreement we entered into with a potential customer. This warrant fully vests on March 4, 2012 if certain product purchasing milestones have been satisfied by the customer as of such date, or upon an earlier change in control and partial satisfaction of such product purchasing milestones. This warrant will expire on the earlier of December 31, 2012, or upon such customer’s failure to meet such product purchasing milestones by (i) March 4, 2012, or (ii) an earlier change in control. The warrant contains provisions for the adjustment of the number of shares issuable upon the exercise of the warrant in the event of stock splits, recapitalizations, reclassifications and consolidations.

As of June 30, 2011, 100,000 shares of our Series C preferred stock were issuable upon exercise of an outstanding warrant to purchase Series C preferred stock with an exercise price of \$1.2847 per share. This warrant was issued in connection with the execution of a strategic collaboration agreement we entered into with a potential distributor. This warrant becomes exercisable upon the completion of certain product qualification and

[Table of Contents](#)

certification milestones, and will expire upon the earlier of (i) a change in control of Enphase, (ii) six months after becoming exercisable, or (iii) immediately prior to the closing of this offering. The warrant contains provisions for the adjustment of the exercise price and the number of shares issuable upon the exercise of the warrant in the event of stock dividends, stock splits, reorganizations and reclassifications. We do not expect that the exercise milestones will be met prior to the closing of this offering, and therefore we expect this warrant will expire.

As of June 30, 2011, an aggregate of 1,470,588 shares of our Series E preferred stock were issuable upon exercise of two outstanding warrants to purchase Series E preferred stock, each with an exercise price of \$0.68 per share. These warrants were issued in connection with the execution of certain credit facilities we entered into with three lenders. These warrants are immediately exercisable and will expire upon the later of (i) ten years after the issuance date of each respective warrant, or (i) five years after the closing of this offering. These warrants have a net exercise provision under which the holder may, in lieu of payment of the exercise price in cash, surrender the warrants and receive a net amount of shares based on the fair market value of our common stock at the time of exercise of the warrants after deduction of the aggregate exercise price. The warrants contain provisions for the adjustment of the exercise price and the number of shares issuable upon the exercise of the warrants in the event of stock dividends, stock splits, reorganizations and reclassifications and consolidations. Following the closing of this offering, these warrants will be exercisable for an aggregate of 1,470,588 shares of our common stock.

As of June 30, 2011, an aggregate of 229,591 shares of our Series E preferred stock were issuable upon exercise of an outstanding warrant to purchase Series E preferred stock, each with an exercise price of \$0.98 per share. These warrants were issued in connection with the execution of an equipment financing facility. These warrants are immediately exercisable and will expire upon the later of (i) ten years after the issuance date of each respective warrant, or (i) five years after the closing of this offering. The warrants contain provisions for the adjustment of the exercise price and the number of shares issuable upon the exercise of the warrants in the event of stock dividends, stock splits, reorganizations and reclassifications and consolidations. Following the closing of this offering, these warrants will be exercisable for an aggregate of 229,591 shares of our common stock.

As of June 30, 2011, an aggregate of 695,586 shares of our common stock were issuable upon exercise of outstanding warrants to purchase common stock with an exercise price of \$0.58 per share. These warrants were issued to certain existing preferred stockholders in connection with our junior secured convertible loan facility. The warrants are immediately exercisable and will expire on June 14, 2016, subject to earlier termination upon an acquisition of Enphase in which the consideration payable to holders of our common stock consists of cash and/or a class of securities that are registered under the Securities Exchange Act of 1934, as amended. The warrants contain provisions for the adjustment of the exercise price and/or the number of shares issuable upon the exercise of the warrants in the event of stock dividends, stock splits, stock combinations, reorganizations, reclassifications, exchanges, substitutions and consolidations.

Registration Rights

Following the closing of this offering, certain holders of our common stock, or their transferees, will be entitled to the registration rights set forth below with respect to registration of the resale of such shares under the Securities Act pursuant to an investors' rights agreement by and among us and certain of our stockholders.

Demand registration rights. Following the closing of this offering, the holders of approximately 228,552,739 shares of our common stock will be entitled to certain demand registration rights. At any time after six months following completion of this offering, the holders of at least a majority of these shares have the right to request that we file up to two registration statements. We may postpone the filing of a registration statement for up to 90 days if we determine that the filing would be seriously detrimental to us and our stockholders, and the underwriters of an underwritten offering will have the right, subject to certain restrictions, to limit the number of shares registered by these holders for reasons relating to the marketing of the shares.

[Table of Contents](#)

Piggyback registration rights. Following the closing of this offering, if we propose to register any of our securities for public sale, the holders of approximately 230,023,327 shares of our common stock will be entitled to certain “piggyback” registration rights allowing the holders to include their shares in such registration. However, this right does not apply to a registration relating to any of our employee benefit plans, the exchange of securities in certain corporate reorganizations or certain other transactions or the issuance of common stock upon conversion of debt securities, the offer and sale of which are also being registered. The underwriters of any underwritten offering will have the right to limit the number of shares registered by these holders for reasons relating to the marketing of the shares, but not below 30% of the total number of shares included in the registration statement.

Form S-3 registration rights. Following the closing of this offering, the holders of approximately 230,023,327 shares of our common stock will be entitled to certain Form S-3 registration rights. At any time after we are eligible to file a registration statement on Form S-3, holders of at least 25% of these shares have the right to request that we effect a registration on Form S-3 if the proposed aggregate offering price of the shares to be registered by the holders requesting registration is at least \$1,000,000. We will not be required to effect such a registration if we have effected one such registration within the 24-month period preceding a request and we may postpone the filing of a registration statement on Form S-3 for up to 90 days if we determine that the filing would be seriously detrimental to us and our stockholders. The underwriters of any underwritten offering will have the right, subject to certain restrictions, to limit the number of shares registered by these holders for reasons relating to the marketing of the shares.

Registration expenses. We will pay all expenses incurred by holders of shares registered in connection with up to two demand registrations and all piggyback and Form S-3 registrations except, in each case, for fees and expenses of legal counsel in excess of \$50,000, underwriting discounts, selling commissions and transfer taxes. However, subject to limited exceptions, we will not pay for any expenses of any demand registration if the request is subsequently withdrawn by the holders or if the net proceeds requirement of a demand registration is not met.

Expiration of registration rights. The registration rights described above will expire five years after the closing of this offering, or, with respect to any particular stockholder, when such stockholder is able to sell all of its shares pursuant to Rule 144 of the Securities Act or a similar exemption in any three-month period.

Holders of substantially all of our shares with these registration rights have signed agreements with the underwriters or us prohibiting the exercise of their registration rights for 180 days, subject to possible extension of up to 35 additional days beyond the end of such 180-day period, following the date of this prospectus. These agreements are described below under the section entitled “Underwriters.”

Anti-Takeover Effects of Delaware Law and Our Charter Documents

Some of the provisions of Delaware law may have the effect of delaying, deferring, discouraging or preventing another person from acquiring control of our company.

We are subject to the provisions of Section 203 of the Delaware General Corporation Law regulating corporate takeovers. This section prevents some Delaware corporations from engaging, under some circumstances, in a business combination, which includes a merger or sale of at least 10% of the corporation’s assets with any interested stockholder, meaning a stockholder who owns 15% or more of the corporation’s outstanding voting stock, or is an affiliate or associate of the corporation and within three years prior to the determination of interested stockholder status, did own 15% or more of the corporation’s outstanding voting stock, or is an affiliate or associate of such person unless:

- the transaction is approved by the board of directors prior to the time that the interested stockholder became an interested stockholder;

[Table of Contents](#)

- upon consummation of the transaction which resulted in the stockholder's becoming an interested stockholder, the interested stockholder owned at least 85% of the voting stock of the corporation outstanding at the time the transaction commenced; or
- at or subsequent to such time that the stockholder became an interested stockholder the business combination is approved by the board of directors and authorized at an annual or special meeting of stockholders by at least two-thirds of the outstanding voting stock which is not owned by the interested stockholder.

A Delaware corporation may "opt out" of these provisions with an express provision in its original certificate of incorporation or an express provision in its certificate of incorporation or bylaws resulting from a stockholders' amendment approved by at least a majority of the outstanding voting shares. We do not plan to "opt out" of these provisions. The statute could prohibit or delay mergers or other takeover or change in control attempts and, accordingly, may discourage attempts to acquire us.

Certain provisions in our amended and restated certificate of incorporation and our amended and restated bylaws that will be in effect upon the closing of this offering could have an effect of delaying, deferring or preventing a change in control. For a description of such provisions, see "Risk Factors—Our charter documents and Delaware law could prevent a takeover that stockholders consider favorable and could also reduce the market price of our stock."

Listing

We intend to apply for the listing of our common stock on the NASDAQ Global Market under the trading symbol "ENPH."

Transfer Agent and Registrar

Upon the completion of this offering, the transfer agent and registrar for our common stock will be American Stock Transfer & Trust Company, LLC.

SHARES ELIGIBLE FOR FUTURE SALE

Prior to this offering, there has not been any public market for our common stock, and we make no prediction as to the effect, if any, that market sales of shares of our common stock or the availability of shares of our common stock for sale will have on the market price of our common stock prevailing from time to time. Nevertheless, sales of substantial amounts of our common stock in the public market, or the perception that such sales could occur, could adversely affect the market price of our common stock and could impair our future ability to raise capital through the sale of equity securities.

Based on the number of shares of common stock outstanding as of June 30, 2011, upon completion of this offering we will have an aggregate of shares of common stock outstanding, assuming no exercise of the underwriters' over-allotment option and no exercise of outstanding options. Of the outstanding shares, all of the shares sold in this offering, plus any additional shares sold upon exercise of the underwriters' over-allotment option, will be freely tradable, except that any shares purchased by "affiliates" (as that term is defined in Rule 144 under the Securities Act), may only be sold in compliance with the limitations described below. The remaining 241,996,235 shares of common stock will be deemed "restricted securities" as defined in Rule 144. Restricted securities may be sold in the public market only if the sale is registered or if the sale qualifies for an exemption from registration under Rule 144 or Rule 701, promulgated under the Securities Act, which rules are summarized below.

As a result of the contractual lock-up restrictions described below and the provisions of Rules 144 and 701, the restricted shares will be available for sale in the public market as follows:

- no shares will be eligible for sale immediately upon completion of this offering; and
- 241,996,235 shares will be eligible for sale upon the expiration of lock-up agreements, subject in some cases to volume and other restrictions of Rule 144 and Rule 701 under the Securities Act.

The number of shares eligible for sale upon expiration of lock-up agreements assumes the conversion of all outstanding shares of our preferred stock into an aggregate of 228,552,739 shares of common stock.

Lock-Up Agreements and Obligations

We, all of our directors and executive officers and substantially all of our stockholders have entered into lock-up agreements that generally provide that we and they will not (1) offer, pledge, sell, contract to sell, sell any option or contract to purchase, purchase any option or contract to sell, grant any option, right or warrant to purchase, or otherwise transfer or dispose of, directly or indirectly, any shares of common stock or any securities convertible into or exchangeable for shares of common stock, or (2) enter into any swap or other agreement that transfers, in whole or in part, any of the economic consequences of ownership of any shares of common stock or such other securities, without the prior written consent of Morgan Stanley & Co. LLC for a period of 180 days from the date of this prospectus, subject to certain exceptions described under the heading "Underwriters."

The 180-day restricted period described above is subject to extension such that, in the event that either (1) during the last 17 days of the 180-day restricted period, we issue an earnings release or material news or a material event relating to us occurs; or (2) prior to the expiration of the 180-day restricted period, we announce that we will release earnings results during the 16-day period beginning on the last day of the 180-day period, the restrictions described above will continue to apply until the expiration of the 18-day period beginning on the issuance of the earnings release or the occurrence of the material new or material event.

In addition, each grant agreement under our 2006 Equity Incentive Plan contains restrictions similar to those set forth in the lock-up agreements described above limiting the disposition of securities issuable pursuant to those plans for a period of at least 180 days following the date of this prospectus.

Rule 144

In general, under Rule 144 of the Securities Act as currently in effect, once we have been subject to public company reporting requirements for at least 90 days, a person who is not deemed to have been one of our affiliates for purposes of the Securities Act at any time during 90 days preceding a sale and who has beneficially owned the shares proposed to be sold for at least six months, including the holding period of any prior owner other than our affiliates, is entitled to sell such shares without complying with the manner of sale, volume limitation or notice provisions of Rule 144, subject to compliance with the public information requirements of Rule 144. If such a person has beneficially owned the shares proposed to be sold for at least one year, including the holding period of any prior owner other than our affiliates, then such person is entitled to sell such shares without complying with any of the requirements of Rule 144.

In general, under Rule 144, as currently in effect, our affiliates or persons selling shares on behalf of our affiliates are entitled to sell, upon expiration of the lock-up agreements described above and under the section "Underwriters", within any three-month period beginning 90 days after the date of this prospectus, a number of shares that does not exceed the greater of:

- 1% of the number of shares of common stock then outstanding, which will equal approximately _____ shares immediately after this offering, based on shares of common stock outstanding on June 30, 2011 and the other assumptions set forth above; or
- the average weekly trading volume of the common stock during the four calendar weeks preceding the filing of a notice on Form 144 with respect to such sale.

Sales under Rule 144 by our affiliates or persons selling shares on behalf of our affiliates are also subject to certain manner of sale provisions and notice requirements and to the availability of current public information about us.

Rule 701

Rule 701 generally allows a stockholder who purchased shares of our common stock pursuant to a written compensatory plan or contract and who is not deemed to have been an affiliate of our company during the immediately preceding 90 days to sell these shares in reliance upon Rule 144, but without being required to comply with the public information, holding period, volume limitation or notice provisions of Rule 144. Rule 701 also permits affiliates of our company to sell their Rule 701 shares under Rule 144 without complying with the holding period requirements of Rule 144. All holders of Rule 701 shares, however, are required to wait until 90 days after the date of this prospectus before selling such shares pursuant to Rule 701. However, substantially all Rule 701 shares are subject to lock-up agreements as described above and under the section "Underwriters" and will become eligible for sale at the expiration of those agreements.

As of June 30, 2011, 6,262,887 shares of our outstanding common stock had been issued in reliance on Rule 701 as a result of exercises of stock options and stock awards. These shares will be eligible for resale in reliance on this rule upon the expiration of the lock-up agreements described above.

Stock Plans

We intend to file registration statements on Form S-8 under the Securities Act covering all of the shares of our common stock subject to options outstanding or reserved for issuance under our stock plans, including our 2011 Employee Stock Purchase Plan. We expect to file this registration statement as soon as practicable after this offering. Accordingly, shares registered under the registration statement on Form S-8 will be available for sale in the open market following its effective date, subject to the lock-up agreements described above and the Rule 144 limitations applicable to affiliates.

Registration Rights

Upon completion of this offering, the holders of an aggregate of 228,552,739 shares of our common stock, based on shares of common stock outstanding on June 30, 2011 and the other assumptions set forth above, or their transferees, will be entitled to rights with respect to the registration of their shares under the Securities Act. Registration of these shares under the Securities Act will result in these shares becoming freely tradable without restriction under the Securities Act immediately upon the effectiveness of such registration. For a further description of these rights, see the section entitled “Description of Capital Stock—Registration Rights.”

MATERIAL U.S. FEDERAL INCOME AND ESTATE TAX CONSEQUENCES TO NON-U.S. HOLDERS

The following summary describes the material U.S. federal income and estate tax consequences of the acquisition, ownership and disposition of our common stock acquired in this offering by Non-U.S. Holders (as defined below). This discussion does not address all aspects of U.S. federal income and estate taxes and does not deal with foreign, state and local consequences that may be relevant to Non-U.S. Holders in light of their particular circumstances, nor does it address U.S. federal tax consequences other than income and estate taxes. Special rules different from those described below may apply to certain Non-U.S. Holders that are subject to special treatment under the Internal Revenue Code of 1986, as amended, or the Code, such as financial institutions, insurance companies, tax-exempt organizations, broker-dealers and traders in securities, U.S. expatriates, “controlled foreign corporations,” “passive foreign investment companies,” corporations that accumulate earnings to avoid U.S. federal income tax, persons that hold our common stock as part of a “straddle,” “hedge,” “conversion transaction,” “synthetic security” or integrated investment or other risk reduction strategy, partnerships and other pass-through entities, and investors in such pass-through entities or an entity that is treated as a disregarded entity for U.S. federal income tax purposes (regardless of its place of organization or formation). Such Non-U.S. Holders are urged to consult their own tax advisors to determine the U.S. federal, state, local and other tax consequences that may be relevant to them. Furthermore, the discussion below is based upon the provisions of the Code, and Treasury regulations, rulings and judicial decisions thereunder as of the date hereof, and such authorities may be repealed, revoked or modified, perhaps retroactively, so as to result in U.S. federal income and estate tax consequences different from those discussed below. We have not requested a ruling from the U.S. Internal Revenue Service, or IRS, with respect to the statements made and the conclusions reached in the following summary, and there can be no assurance that the IRS will agree with such statements and conclusions. This discussion assumes that the Non-U.S. Holder holds our common stock as a “capital asset” within the meaning of Section 1221 of the Code (generally, property held for investment).

The following discussion is for general information only. Persons considering the purchase of our common stock pursuant to this offering should consult their own tax advisors concerning the U.S. federal income and estate tax consequences of acquiring, owning and disposing of our common stock in light of their particular situations as well as any consequences arising under the laws of any other taxing jurisdiction, including any state, local or foreign tax consequences.

For the purposes of this discussion, a “Non-U.S. Holder” is, for U.S. federal income tax purposes, a beneficial owner of common stock that is not a U.S. Holder, a partnership or other pass-through entity, or a disregarded entity. A “U.S. Holder” means a beneficial owner of our common stock that is for U.S. federal income tax purposes (a) an individual who is a citizen or resident of the United States, (b) a corporation or other entity treated as a corporation created or organized in or under the laws of the United States, any state thereof or the District of Columbia, (c) an estate the income of which is subject to U.S. federal income taxation regardless of its source or (d) a trust if it (1) is subject to the primary supervision of a court within the United States and one or more U.S. persons have the authority to control all substantial decisions of the trust or (2) has a valid election in effect under applicable U.S. Treasury regulations to be treated as a U.S. person.

Distributions

Subject to the discussion below, distributions, if any, made on our common stock to a Non-U.S. Holder of our common stock to the extent made out of our current or accumulated earnings and profits (as determined under U.S. federal income tax principles) generally will constitute dividends for U.S. tax purposes and will be subject to withholding tax at a 30% rate or such lower rate as may be specified by an applicable income tax treaty. To obtain a reduced rate of withholding under a treaty, a Non-U.S. Holder generally will be required to provide us with a properly executed IRS Form W-8BEN, or other appropriate form, certifying the Non-U.S. Holder’s entitlement to benefits under that treaty. In the case of a Non-U.S. Holder that is an entity, Treasury

[Table of Contents](#)

Regulations and the relevant tax treaty provide rules to determine whether, for purposes of determining the applicability of a tax treaty, dividends will be treated as paid to the entity or to those holding an interest in that entity. If a Non-U.S. Holder holds stock through a financial institution or other agent acting on the holder's behalf, the holder will be required to provide appropriate documentation to such agent. The holder's agent will then be required to provide certification to us or our paying agent, either directly or through other intermediaries. If you are eligible for a reduced rate of U.S. federal withholding tax under an income tax treaty, you should consult with your own tax advisor to determine if you are able to obtain a refund or credit of any excess amounts withheld by timely filing an appropriate claim for a refund with the IRS.

We generally are not required to withhold tax on dividends paid to a Non-U.S. Holder that are effectively connected with the Non-U.S. Holder's conduct of a trade or business within the United States (and, if required by an applicable income tax treaty, are attributable to a permanent establishment that such holder maintains in the United States) if a properly executed IRS Form W-8ECI, stating that the dividends are so connected, is furnished to us (or, if stock is held through a financial institution or other agent, to such agent). In general, such effectively connected dividends will be subject to U.S. federal income tax, on a net income basis at the regular graduated rates generally in the same manner as a U.S. person. A corporate Non-U.S. Holder receiving effectively connected dividends may also be subject to an additional "branch profits tax," which is imposed, under certain circumstances, at a rate of 30% (or such lower rate as may be specified by an applicable treaty) on the corporate Non-U.S. Holder's effectively connected earnings and profits, subject to certain adjustments.

To the extent distributions on our common stock, if any, exceed our current and accumulated earnings and profits, they will constitute a non-taxable return of capital and will first reduce your adjusted basis in our common stock, but not below zero, and then will be treated as gain and taxed in the same manner as gain realized from a sale or other disposition of common stock as described in the next section.

Gain on Disposition of Our Common Stock

A Non-U.S. Holder generally will not be subject to U.S. federal income tax with respect to gain realized on a sale or other disposition of our common stock unless (a) the gain is effectively connected with a trade or business of such holder in the United States (and, if required by an applicable income tax treaty, is attributable to a permanent establishment that such holder maintains in the United States), (b) the Non-U.S. Holder is a nonresident alien individual and is present in the United States for 183 or more days in the taxable year of the disposition and certain other conditions are met, or (c) we are or have been a "United States real property holding corporation" within the meaning of Code Section 897(c)(2) at any time within the shorter of the five-year period preceding such disposition or such holder's holding period. In general, we would be a United States real property holding corporation if interests in U.S. real estate comprised (by fair market value) at least half of our business assets. We believe that we are not, and do not anticipate becoming, a United States real property holding corporation. Even if we are treated as a United States real property holding corporation, gain realized by a Non-U.S. Holder on a disposition of our common stock will not be subject to U.S. federal income tax so long as (1) the Non-U.S. Holder owned, directly, indirectly and constructively, no more than five percent of our common stock at all times within the shorter of (i) the five-year period preceding the disposition or (ii) the holder's holding period and (2) our common stock is regularly traded on an established securities market. There can be no assurance that our common stock will continue to qualify as regularly traded on an established securities market.

If you are a Non-U.S. Holder described in (a) above, you will be required to pay tax on the net gain derived from the sale at regular graduated U.S. federal income tax rates generally in the same manner as a U.S. person, and corporate Non-U.S. Holders described in (a) above may be subject to the additional branch profits tax at a 30% rate or such lower rate as may be specified by an applicable income tax treaty. If you are an individual Non-U.S. Holder described in (b) above, you will be required to pay a flat 30% tax on the gain derived from the sale, which gain may be offset by U.S. source capital losses (even though you are not considered a resident of the United States).

Information Reporting Requirements and Backup Withholding

Generally, we or certain financial middlemen must report information to the IRS with respect to any dividends we pay on our common stock including the amount of any such dividends, the name and address of the recipient, and the amount, if any, of tax withheld. A similar report is sent to the holder to whom any such dividends are paid. Pursuant to tax treaties or certain other agreements, the IRS may make its reports available to tax authorities in the recipient's country of residence.

Dividends paid by us (or our paying agents) to a Non-U.S. Holder may also be subject to U.S. backup withholding. U.S. backup withholding generally will not apply to a Non-U.S. Holder who provides a properly executed IRS Form W-8BEN or otherwise establishes an exemption. The current backup withholding rate is 28%.

Under current U.S. federal income tax law, U.S. information reporting and backup withholding requirements generally will apply to the proceeds of a disposition of our common stock effected by or through a U.S. office of any broker, U.S. or foreign, except that information reporting and such requirements may be avoided if the holder provides a properly executed IRS Form W-8BEN, satisfies documentary evidence requirements for establishing Non-U.S. Holder status or otherwise establishes an exemption. Generally, U.S. information reporting and backup withholding requirements will not apply to a payment of disposition proceeds to a Non-U.S. Holder where the transaction is effected outside the United States through a non-U.S. office of a non-U.S. broker. Information reporting and backup withholding requirements may, however, apply to a payment of disposition proceeds if the broker has actual knowledge, or reason to know, that the holder is, in fact, a U.S. person. For information reporting purposes, certain brokers with substantial U.S. ownership or operations will generally be treated in a manner similar to U.S. brokers.

If backup withholding is applied to you, you should consult with your own tax advisor to determine if you are able to obtain a tax benefit or credit with respect to such backup withholding.

Recently Enacted Legislation Affecting Taxation of Our Common Stock Held by or Through Foreign Entities

Recently enacted legislation generally will impose a U.S. federal withholding tax of 30% on dividends and the gross proceeds of a disposition of our common stock paid after December 31, 2012 to a foreign financial institution (as specifically defined for this purpose) unless such institution enters into an agreement with the U.S. government to withhold on certain payments and to collect and provide to the U.S. tax authorities substantial information regarding U.S. account holders of such institution (which includes certain equity and debt holders of such institution, as well as certain account holders that are foreign entities with U.S. owners). The legislation also will generally impose a U.S. federal withholding tax of 30% on dividends and the gross proceeds of a disposition of our common stock paid after December 31, 2012 to a non-financial foreign entity unless such entity provides the withholding agent with either a certification that it does not have any substantial direct or indirect U.S. owners or provides information regarding direct and indirect U.S. owners of the entity. Under certain circumstances, a Non-U.S. Holder might be eligible for refunds or credits of such taxes. Holders are encouraged to consult with their own tax advisors regarding the possible implications of the legislation on their investment in our common stock.

Federal Estate Tax

An individual Non-U.S. Holder who is treated as the owner of, or has made certain lifetime transfers of, an interest in our common stock will be required to include the value thereof in his or her gross estate for U.S. federal estate tax purposes, and may be subject to U.S. federal estate tax unless an applicable estate tax treaty provides otherwise, even though such individual was not a citizen or resident of the United States at the time of his or her death.

THE PRECEDING DISCUSSION OF U.S. FEDERAL INCOME AND ESTATE TAX CONSIDERATIONS IS FOR GENERAL INFORMATION ONLY. EACH PROSPECTIVE INVESTOR SHOULD CONSULT ITS OWN TAX ADVISOR REGARDING THE TAX CONSEQUENCES OF PURCHASING, HOLDING AND DISPOSING OF OUR COMMON STOCK, INCLUDING THE CONSEQUENCES OF ANY PROPOSED CHANGE IN APPLICABLE LAW.

UNDERWRITERS

Under the terms and subject to the conditions in an underwriting agreement dated the date of this prospectus, the underwriters named below, for whom Morgan Stanley & Co. LLC and Merrill Lynch, Pierce, Fenner & Smith Incorporated are acting as representatives, have severally agreed to purchase, and we have agreed to sell to them, severally, the number of shares indicated below:

<u>Name</u>	<u>Number of Shares</u>
Morgan Stanley & Co. LLC	
Merrill Lynch, Pierce, Fenner & Smith Incorporated	
Jefferies & Company, Inc.	
Lazard Capital Markets LLC	
ThinkEquity LLC	
Total	<u><u> </u></u>

The underwriters and the representatives are collectively referred to as the “underwriters” and the “representatives,” respectively. The underwriters are offering the shares of common stock subject to their acceptance of the shares from us and subject to prior sale. The underwriting agreement provides that the obligations of the several underwriters to pay for and accept delivery of the shares of common stock offered by this prospectus are subject to the approval of certain legal matters by their counsel and to certain other conditions. The underwriters are obligated to take and pay for all of the shares of common stock offered by this prospectus if any such shares are taken. However, the underwriters are not required to take or pay for the shares covered by the underwriters’ option to purchase additional shares described below.

The underwriters initially propose to offer part of the shares of common stock directly to the public at the offering price listed on the cover page of this prospectus and part to certain dealers at a price that represents a concession not in excess of \$ per share. After the initial offering of the shares of common stock, the offering price and other selling terms may from time to time be varied by the representative.

We have granted to the underwriters an option, exercisable for 30 days from the date of this prospectus, to purchase up to additional shares of common stock at the public offering price listed on the cover page of this prospectus, less underwriting discounts and commissions. The underwriters may exercise this option solely for the purpose of covering over-allotments, if any, made in connection with the offering of the shares of common stock offered by this prospectus. To the extent the option is exercised, each underwriter will become obligated, subject to certain conditions, to purchase about the same percentage of the additional shares of common stock as the number listed next to the underwriter’s name in the preceding table bears to the total number of shares of common stock listed next to the names of all underwriters in the preceding table.

The estimated offering expenses payable by us, in addition to the underwriting discounts and commissions, are approximately \$ million.

The following table shows the per share and total public offering price, underwriting discounts and commissions, and proceeds before expenses to us. These amounts are shown assuming both no exercise and full exercise of the underwriters’ option to purchase up to an additional shares of common stock.

	<u>Per Share</u>	<u>Total</u>	
		<u>No Exercise</u>	<u>Full Exercise</u>
Public offering price	\$	\$	\$
Underwriting discounts and commissions to be paid by us	\$	\$	\$
Proceeds, before expenses, to us	\$	\$	\$

Table of Contents

The underwriters have informed us that they do not intend sales to discretionary accounts to exceed 5% of the total number of shares of common stock offered by them.

We applied to list our common stock on the NASDAQ Global Market under the symbol “ENPH.”

We and all directors and officers and the holders of all of our outstanding stock and stock options have agreed that, without the prior written consent of Morgan Stanley & Co. LLC on behalf of the underwriters, we and they will not, during the period ending 180 days after the date of this prospectus:

- offer, pledge, sell, contract to sell, sell any option or contract to purchase, purchase any option or contract to sell, grant any option, right or warrant to purchase, lend, or otherwise transfer or dispose of, directly or indirectly, any shares of common stock or any securities convertible into or exercisable or exchangeable for shares of common stock;
- enter into any swap or other arrangement that transfers to another, in whole or in part, any of the economic consequences of ownership of the common stock; or
- file any registration statement with the Securities and Exchange Commission relating to the offering of any shares of common stock or any securities convertible into or exercisable or exchangeable for common stock.

Whether any such transaction described in the first two bullet points above is to be settled by delivery of common stock or such other securities, in cash or otherwise. In addition, we and each such person agree that, without the prior written consent of Morgan Stanley & Co. LLC on behalf of the underwriters, we and such persons will not, during the period ending 180 days after the date of this prospectus, make any demand for, or exercise any right with respect to, the registration of any shares of common stock or any security convertible into or exercisable or exchangeable for common stock.

The restrictions described in the two immediately preceding paragraphs do not apply to:

- the sale by us of shares of common stock pursuant to the underwriting agreement;
- the issuance by us of shares of common stock upon the exercise of an option or a warrant or the conversion of a security outstanding on the date of this prospectus and as described in this prospectus;
- transactions by a director, officer or stockholder relating to shares of common stock or other securities acquired in open market transactions after the completion of the offering of the shares; provided that no filing under Section 16(a) of the Securities Exchange Act of 1934, as amended, is required or voluntarily made in connection with subsequent sales of the common stock or other securities acquired in such open market transactions;
- transfers of shares of common stock or any securities convertible into common stock by a director, officer or stockholder (i) as a bona fide gift, (ii) by will or intestate succession or (iii) to any trust for the direct or indirect benefit of the director, officer, stockholder or an immediate family member, provided that it shall be a condition of the transfer that each transferee or donee shall sign and deliver a copy of the lock-up agreement prior to or upon such transfer and no filing under Section 16(a) of the Exchange Act reporting a disposition of shares of common stock or any other reduction in beneficial ownership of shares of common stock shall be required or shall be made voluntarily during the 180-day restricted period;
- transfers or distributions of shares of common stock or any securities convertible into common stock by a stockholder that is a corporation, partnership, limited liability company or other business entity (i) to any stockholder, partner or member of, or owner of a similar equity interest in, such stockholder, as the case may be, (ii) in connection with the sale or other bona fide transfer in a single transaction of all or substantially all of the stockholder’s capital stock, partnership interests, membership interests or other similar equity interests, as the case may be, or all or substantially all of the stockholder’s assets,

Table of Contents

in any such case not undertaken for the purpose of avoiding the restrictions imposed by the lock-up agreement or (iii) to another corporation, partnership, limited liability company or other business entity so long as the transferee is an affiliate of the stockholder, provided that it shall be a condition of the transfer that each transferee or donee shall sign and deliver a copy of the lock-up agreement prior to or upon such transfer and no filing under Section 16(a) of the Exchange Act reporting a disposition of shares of common stock or any other reduction in beneficial ownership of shares of common stock shall be required or shall be made voluntarily during the 180-day restricted period;

- the establishment by a director, officer or stockholder of a trading plan pursuant to Rule 10b5-1 under the Securities Exchange Act of 1934, as amended, for the transfer of shares of common stock, provided that such plan does not provide for the transfer of common stock during the restricted period and no public announcement or filing under the Securities Exchange Act of 1934, as amended, regarding the establishment of such plan shall be required or shall be voluntarily made;
- the exercise of options granted under our 2006 Equity Incentive Plan, 2011 Equity Incentive Plan, or 2011 Employee Stock Purchase Plan or warrants outstanding on the date of this prospectus, in each case by a director, officer or stockholder, provided that it shall be a condition of the transfer that shares received upon such exercise shall be subject to the lock-up restrictions and no filing under Section 16(a) of the Exchange Act reporting the disposition of shares of common stock or any other reduction in the beneficial ownership of shares is required or voluntarily made in connection with these transactions during this 180-day restricted period;
- the issuance by us of shares of common stock, or other securities convertible into or exercisable for common stock, stock pursuant to our equity incentive plans described in this prospectus, provided that the recipient of such shares or options shall sign and deliver a copy of the lock-up agreement to the extent such shares or options become vested within 180 days after the date of this prospectus;
- transfers by a director, officer or stockholder to us of shares of common stock or other securities convertible into or exercisable or exchangeable for common stock (i) upon a vesting event of such securities or the exercise of options issued pursuant to our 2006 Equity Incentive Plan, 2011 Equity Incentive Plan, or 2011 Employee Stock Purchase Plan in full or partial payment of taxes or tax withholding obligations required to be paid or satisfied upon such vesting or exercise or (ii) in exercise of our right to repurchase or reacquire securities pursuant to agreements that permit us to repurchase or reacquire such securities upon termination of services to the company, provided that it shall be a condition of the transfer that no filing under Section 16(a) of the Exchange Act, reporting a disposition of shares of Common Stock or any other reduction in beneficial ownership of shares of Common Stock, shall be required or shall be voluntarily made during this 180-day restricted period;
- transfers by a director, officer or stockholder of shares of common stock acquired pursuant to our 2011 Employee Stock Purchase Plan, provided that it shall be a condition of the transfer that no filing under Section 16(a) of the Exchange Act shall be required or shall be voluntarily made in connection with such transfer during this 180-day restricted period;
- transfers by a director, officer or stockholder pursuant to a sale or an offer to purchase 100% of our outstanding common stock, whether pursuant to a merger, tender offer or otherwise, to a third party or group of third parties; and
- the filing by us of a registration statement on Form S-8 in respect of any shares issued under or the grant of any award pursuant to an employee benefit plan described in this prospectus.

The 180-day restricted period described in the immediately preceding paragraph will be extended if:

- during the last 17 days of the 180-day restricted period we issue an earnings release or material news or a material event relating to us occurs, or
- prior to the expiration of the 180-day restricted period, we announce that we will release earnings results during the 16-day period beginning on the last day of the 180-day period or provide notification

[Table of Contents](#)

to Morgan Stanley & Co. LLC of any earnings release or material news or material event that may give rise to an extension of the initial 180-day restricted period,

in which case the restrictions described in the immediately preceding paragraph will continue to apply until the expiration of the 18 day period beginning on the issuance of the earnings release or the occurrence of the material news or material event.

Morgan Stanley & Co. LLC, in its sole discretion, may release the common stock and other securities subject to the lock-up agreements described above in whole or in part at any time with or without notice. When determining whether or not to release common stock and other securities from lock-up agreements, Morgan Stanley & Co. LLC will consider, among other factors, the holder's reasons for requesting the release, the number of shares of common stock and other securities for which the release is being requested and market conditions at the time.

In order to facilitate the offering of the common stock, the underwriters may engage in transactions that stabilize, maintain or otherwise affect the price of the common stock. Specifically, the underwriters may sell more shares than they are obligated to purchase under the underwriting agreement, creating a short position. A short sale is covered if the short position is no greater than the number of shares available for purchase by the underwriters under the option to purchase additional shares of common stock. The underwriters can close out a covered short sale by exercising the option to purchase additional shares of common stock or purchasing shares in the open market. In determining the source of shares to close out a covered short sale, the underwriters will consider, among other things, the open market price of shares compared to the price available under the option to purchase additional shares of common stock. The underwriters may also sell shares in excess of the option to purchase additional shares of common stock, creating a naked short position. The underwriters must close out any naked short position by purchasing shares in the open market. A naked short position is more likely to be created if the underwriters are concerned that there may be downward pressure on the price of the common stock in the open market after pricing that could adversely affect investors who purchase in this offering. As an additional means of facilitating the offering, the underwriters may bid for, and purchase, shares of common stock in the open market to stabilize the price of the common stock. These activities may raise or maintain the market price of the common stock above independent market levels or prevent or retard a decline in the market price of the common stock. The underwriters are not required to engage in these activities and may end any of these activities at any time.

We and the underwriters have agreed to indemnify each other against certain liabilities, including liabilities under the Securities Act.

A prospectus in electronic format may be made available on websites maintained by one or more underwriters, or selling group members, if any, participating in this offering. The representatives may agree to allocate a number of shares of common stock to underwriters for sale to their online brokerage account holders. Internet distributions will be allocated by the representatives to underwriters that may make Internet distributions on the same basis as other allocations.

The underwriters and their respective affiliates are full service financial institutions engaged in various activities, which may include securities trading, commercial and investment banking, financial advisory, investment management, principal investment, hedging, financing and brokerage activities. Certain of the underwriters and their respective affiliates may in the future perform various financial advisory and investment banking services for us, for which they may receive customary fees and expenses. In February 2010, we entered into a commercial supply agreement and a related services agreement with MS Solar Solutions Corp., or MSSS, an affiliate of Morgan Stanley & Co. LLC, an underwriter in this offering. Under these agreements, MSSS purchases microinverters from us and then resells them to MSSS project companies in connection with the installation of solar PV systems in the United States. In connection with these agreements, MSSS received a three-year warrant to purchase 100,000 shares of our common stock. This warrant was issued in March 2010 and

[Table of Contents](#)

is exercisable contingent on MSSS purchasing at least 200,000 microinverters from us by March 2012. Morgan Stanley, an affiliate of Morgan Stanley & Co. LLC, has guaranteed the payment obligations of MSSS under the supply agreement. Morgan Stanley's liability under the guarantee is limited to \$100,000.

Lazard Frères & Co. LLC referred this transaction to Lazard Capital Markets LLC and will receive a referral fee from Lazard Capital Markets LLC in connection therewith.

Pricing of the Offering

Prior to this offering, there has been no public market for our common stock. The initial public offering price was determined by negotiations between us and the representatives. Among the factors considered in determining the initial public offering price were our future prospects and those of our industry in general, our sales, earnings and certain other financial and operating information in recent periods, and the price-earnings ratios, price-sales ratios, market prices of securities, and certain financial and operating information of companies engaged in activities similar to ours.

Selling Restrictions

European Economic Area

In relation to each Member State of the European Economic Area which has implemented the Prospectus Directive (each, a "Relevant Member State") an offer to the public of any shares of our common stock may not be made in that Relevant Member State, except that an offer to the public in that Relevant Member State of any shares of our common stock may be made at any time under the following exemptions under the Prospectus Directive, if they have been implemented in that Relevant Member State:

- (a) to any legal entity that is a qualified investor as defined in the Prospectus Directive;
- (b) to fewer than 100 or, if the Relevant Member State has implemented the relevant provision of the 2010 PD Amending Directive, 150 natural or legal persons (other than qualified investors as defined in the Prospectus Directive), as permitted under the Prospectus Directive, subject to obtaining the prior consent of the representatives for any such offer; or
- (c) in any other circumstances falling within Article 3(2) of the Prospectus Directive, provided that no such offer of shares of our common stock shall result in a requirement for the publication by us or any underwriter of a prospectus pursuant to Article 3 of the Prospectus Directive.

For the purposes of this provision, the expression an "offer to the public" in relation to any shares of our common stock in any Relevant Member State means the communication in any form and by any means of sufficient information on the terms of the offer and any shares of our common stock to be offered so as to enable an investor to decide to purchase any shares of our common stock, as the same may be varied in that Member State by any measure implementing the Prospectus Directive in that Member State; the expression "Prospectus Directive" means Directive 2003/71/EC (and amendments thereto, including the 2010 PD Amending Directive, to the extent implemented in the Relevant Member State), and includes any relevant implementing measure in the Relevant Member State; and the expression "2010 PD Amending Directive" means Directive 2010/73/EU.

United Kingdom

Each underwriter has represented and agreed that:

- (a) it has only communicated or caused to be communicated and will only communicate or cause to be communicated an invitation or inducement to engage in investment activity (within the meaning of Section 21 of the FSMA) received by it in connection with the issue or sale of the shares of our common stock in circumstances in which Section 21(1) of the FSMA does not apply to us; and

- (b) it has complied and will comply with all applicable provisions of the FSMA with respect to anything done by it in relation to the shares of our common stock in, from or otherwise involving the United Kingdom.

Switzerland

We have not and will not register with the Swiss Financial Market Supervisory Authority, or FINMA, as a foreign collective investment scheme pursuant to Article 119 of the Federal Act on Collective Investment Scheme of 23 June 2006, as amended, or CISA, and accordingly the securities being offered pursuant to this prospectus have not and will not be approved, and may not be licenseable, with FINMA. Therefore, the securities have not been authorized for distribution by FINMA as a foreign collective investment scheme pursuant to Article 119 CISA and the securities offered hereby may not be offered to the public (as this term is defined in Article 3 CISA) in or from Switzerland. The securities may solely be offered to “qualified investors,” as this term is defined in Article 10 CISA, and in the circumstances set out in Article 3 of the Ordinance on Collective Investment Scheme of 22 November 2006, as amended, or CISO, such that there is no public offer. Investors, however, do not benefit from protection under CISA or CISO or supervision by FINMA. This prospectus and any other materials relating to the securities are strictly personal and confidential to each offeree and do not constitute an offer to any other person. This prospectus may only be used by those qualified investors to whom it has been handed out in connection with the offer described herein and may neither directly or indirectly be distributed or made available to any person or entity other than its recipients. It may not be used in connection with any other offer and shall in particular not be copied and/or distributed to the public in Switzerland or from Switzerland. This prospectus does not constitute an issue prospectus as that term is understood pursuant to Article 652a and/or 1156 of the Swiss Federal Code of Obligations. We have not applied for a listing of the securities on the SIX Swiss Exchange or any other regulated securities market in Switzerland, and consequently, the information presented in this prospectus does not necessarily comply with the information standards set out in the listing rules of the SIX Swiss Exchange and corresponding prospectus schemes annexed to the listing rules of the SIX Swiss Exchange.

Dubai International Financial Centre

This prospectus relates to an Exempt Offer in accordance with the Offered Securities Rules of the Dubai Financial Services Authority, or DFSA. This prospectus is intended for distribution only to persons of a type specified in the Offered Securities Rules of the DFSA. It must not be delivered to, or relied on by, any other person. The DFSA has no responsibility for reviewing or verifying any documents in connection with Exempt Offers. The DFSA has not approved this prospectus nor taken steps to verify the information set forth herein and has no responsibility for the prospectus. The shares to which this prospectus relates may be illiquid and/or subject to restrictions on their resale. Prospective purchasers of the shares offered should conduct their own due diligence on the shares. If you do not understand the contents of this prospectus you should consult an authorized financial advisor.

LEGAL MATTERS

The validity of the shares of common stock offered hereby will be passed upon for us by Cooley LLP, Palo Alto, California. Certain legal matters in connection with this offering will be passed upon for the underwriters by Davis Polk & Wardwell LLP, Menlo Park, California.

EXPERTS

The consolidated financial statements as of December 31, 2009 and 2010, and for each of the three years in the period ended December 31, 2010 included in this prospectus have been audited by Deloitte & Touche LLP, an independent registered public accounting firm, as stated in their report appearing herein and elsewhere in the registration statement. Such consolidated financial statements have been so included in reliance upon the report of such firm given upon their authority as experts in accounting and auditing.

WHERE YOU CAN FIND MORE INFORMATION

We have filed with the SEC a registration statement on Form S-1 under the Securities Act with respect to the shares of common stock we are offering. The registration statement, including the attached exhibits and schedules, contains additional relevant information about us and our common stock. This prospectus does not contain all of the information set forth in the registration statement and the exhibits and schedules thereto. The rules and regulations of the SEC allow us to omit from this prospectus certain information included in the registration statement.

For further information about us and our common stock, you may inspect a copy of the registration statement and the exhibits and schedules to the registration statement without charge at the offices of the SEC at 100 F Street, N.E., Washington, D.C. 20549. You may obtain copies of all or any part of the registration statement from the Public Reference Section of the SEC, 100 F Street, N.E., Washington, D.C. 20549 upon the payment of the prescribed fees. You may obtain information on the operation of the Public Reference Room by calling the SEC at 1-800-SEC-0330. The SEC maintains a website at www.sec.gov that contains reports, proxy and information statements and other information regarding registrants like us that file electronically with the SEC. You can also inspect our registration statement on this website.

Upon completion of this offering, we will become subject to the reporting and information requirements of the Exchange Act, and we will file reports, proxy statements and other information with the SEC.

[Table of Contents](#)

ENPHASE ENERGY, INC.

INDEX TO CONSOLIDATED FINANCIAL STATEMENTS AS OF AND FOR THE YEARS ENDED DECEMBER 31, 2008, 2009 AND 2010 AND
THE THREE MONTHS ENDED MARCH 31, 2010 (UNAUDITED) AND MARCH 31, 2011 (UNAUDITED)

	<u>Page</u>
Report of Independent Registered Public Accounting Firm	F-2
Consolidated Balance Sheets	F-3
Consolidated Statements of Operations	F-4
Consolidated Statements of Stockholders' Equity	F-5
Consolidated Statements of Cash Flows	F-6
Notes to Consolidated Financial Statements	F-7

REPORT OF INDEPENDENT REGISTERED PUBLIC ACCOUNTING FIRM

To the Board of Directors and Shareholders of Enphase Energy, Inc.:

We have audited the accompanying consolidated balance sheets of Enphase Energy, Inc. and subsidiaries (the "Company") as of December 31, 2009 and 2010, and the related consolidated statements of operations, stockholders' equity, and cash flows for each of the three years in the period ended December 31, 2010. These consolidated financial statements are the responsibility of the Company's management. Our responsibility is to express an opinion on these consolidated financial statements based on our audits.

We conducted our audits in accordance with the standards of the Public Company Accounting Oversight Board (United States). Those standards require that we plan and perform the audit to obtain reasonable assurance about whether the financial statements are free of material misstatement. The Company is not required to have, nor were we engaged to perform, an audit of its internal control over financial reporting. Our audit includes consideration of internal control over financial reporting as a basis for designing audit procedures that are appropriate in the circumstances, but not for the purpose of expressing an opinion on the effectiveness of the Company's internal control over financial reporting. Accordingly, we express no such opinion. An audit also includes examining, on a test basis, evidence supporting the amounts and disclosures in the financial statements, assessing the accounting principles used and significant estimates made by management, as well as evaluating the overall financial statement presentation. We believe that our audits provide a reasonable basis for our opinion.

In our opinion, such consolidated financial statements present fairly, in all material respects, the financial position of Enphase Energy, Inc. and subsidiaries as of December 31, 2009 and 2010, and the results of their operations and their cash flows for each of the three years in the period ended December 31, 2010, in conformity with accounting principles generally accepted in the United States of America.

/s/ DELOITTE & TOUCHE LLP

San Francisco, California
April 29, 2011
(June 15, 2011 as to Note 15)

ENPHASE ENERGY, INC.
Consolidated Balance Sheets
(in thousands, except per share data)

	<u>December 31,</u>		<u>March 31,</u> <u>2011</u> <u>(unaudited)</u>	<u>Pro Forma</u> <u>March 31,</u> <u>2011</u> <u>(Note 2)</u>
	<u>2009</u>	<u>2010</u>		
ASSETS				
Current Assets:				
Cash and cash equivalents	\$ 8,642	\$ 39,993	\$ 30,524	\$ 30,524
Accounts receivables, net of allowances of \$50, \$16 and \$13 as of December 31, 2009, December 31, 2010 and March 31, 2011, respectively	6,369	8,024	7,840	7,840
Inventory	1,483	4,521	5,818	5,818
Prepaid expenses and other	189	418	805	805
Total current assets	<u>16,683</u>	<u>52,956</u>	<u>44,987</u>	<u>44,987</u>
Property and equipment, net	3,894	6,103	9,066	9,066
Other assets	370	445	781	781
Total assets	<u>\$ 20,947</u>	<u>\$ 59,504</u>	<u>\$ 54,834</u>	<u>\$ 54,834</u>
LIABILITIES AND STOCKHOLDERS' EQUITY				
Current liabilities:				
Accounts payable	\$ 4,595	\$ 6,521	\$ 6,693	\$ 6,693
Accrued liabilities	799	2,910	3,899	3,899
Deferred revenues	107	595	558	558
Current portion of term loan	178	2,567	2,484	2,484
Convertible preferred stock warrant liability	—	610	954	—
Total current liabilities	<u>5,679</u>	<u>13,203</u>	<u>14,588</u>	<u>13,634</u>
Long-term liabilities:				
Deferred revenues	175	1,044	1,341	1,341
Warranty obligations	1,087	2,328	2,962	2,962
Other liabilities	146	112	269	269
Term loan	233	4,336	6,097	6,097
Total long-term liabilities	<u>1,641</u>	<u>7,820</u>	<u>10,669</u>	<u>10,669</u>
Total liabilities	<u>7,320</u>	<u>21,023</u>	<u>25,257</u>	<u>24,303</u>
Commitments and contingencies				
Stockholders' equity:				
Convertible preferred stock, \$0.00001 par value; 213,913 shares authorized; 134,294, 201,765 and 201,765 shares issued and outstanding at December 31, 2009, December 31, 2010 and March 31, 2011, respectively; aggregate liquidation preference of \$87,262, \$133,142 and \$133,142 at December 31, 2009, December 31, 2010 and March 31, 2011, respectively; no shares authorized, issued or outstanding pro forma	47,859	93,596	93,596	—
Common stock, \$0.00001 par value; 308,000 shares authorized; 6,653, 7,662 and 7,745 shares issued at December 31, 2009, December 31, 2010 and March 31, 2011, respectively; 236,297 shares issued and outstanding pro forma	—	—	—	2
Additional paid-in capital	509	1,403	1,788	96,336
Accumulated deficit	<u>(34,741)</u>	<u>(56,518)</u>	<u>(65,807)</u>	<u>(65,807)</u>
Total stockholders' equity	<u>13,627</u>	<u>38,481</u>	<u>29,577</u>	<u>30,531</u>
Total liabilities and stockholders' equity	<u>\$ 20,947</u>	<u>\$ 59,504</u>	<u>\$ 54,834</u>	<u>\$ 54,834</u>

See notes to consolidated financial statements.

ENPHASE ENERGY, INC.
Consolidated Statements of Operations
(in thousands, except per share data)

	Year Ended December 31,			Three Months Ended March 31,	
	2008	2009	2010	2010 (unaudited)	2011
Net revenues	\$ 1,668	\$ 20,194	\$ 61,661	\$ 11,587	\$ 18,069
Cost of revenues	7,475	23,223	55,159	10,631	15,421
Gross profit (loss)	(5,807)	(3,029)	6,502	956	2,648
Operating expenses:					
Research and development	5,354	8,411	14,296	2,735	5,345
Sales and marketing	1,809	2,651	6,558	855	3,010
General and administrative	1,727	2,603	6,365	1,099	3,250
Total operating expenses	8,890	13,665	27,219	4,689	11,605
Loss from operations	(14,697)	(16,694)	(20,717)	(3,733)	(8,957)
Other income (expense), net:					
Interest income	206	125	39	10	4
Interest expense	(9)	(356)	(914)	(75)	(280)
Other income (expense)	(1)	—	(185)	(1)	(56)
Total other income (expense), net	196	(231)	(1,060)	(66)	(332)
Net loss	<u>\$(14,501)</u>	<u>\$(16,925)</u>	<u>\$(21,777)</u>	<u>\$ (3,799)</u>	<u>\$ (9,289)</u>
Net loss attributable to common stockholders	<u>\$(14,501)</u>	<u>\$(16,925)</u>	<u>\$(21,777)</u>	<u>\$ (3,799)</u>	<u>\$ (9,289)</u>
Net loss per share attributable to common stockholders, basic and diluted	<u>\$ (2.72)</u>	<u>\$ (2.85)</u>	<u>\$ (3.19)</u>	<u>\$ (0.59)</u>	<u>\$ (1.21)</u>
Shares used in computing net loss per share attributable to common stockholders, basic and diluted	<u>5,333</u>	<u>5,932</u>	<u>6,829</u>	<u>6,434</u>	<u>7,695</u>
Pro forma net loss per share attributable to common stockholders, basic and diluted (unaudited)			<u>\$ (0.10)</u>		<u>\$ (0.04)</u>
Pro forma shares used in computing pro forma net loss per share attributable to common stockholders, basic and diluted (unaudited)			<u>216,536</u>		<u>236,248</u>

See notes to consolidated financial statements.

ENPHASE ENERGY, INC.
Consolidated Statements of Stockholders' Equity
(in thousands, except per share amounts)

	Convertible Preferred Stock										Common Stock		Additional Paid-In Capital	Accumulated Deficit	Total Stockholders' Equity
	Series A		Series B		Series C		Series D		Series E		Shares	Amount			
	Shares	Amount	Shares	Amount	Shares	Amount	Shares	Amount	Shares	Amount					
BALANCE — December 31, 2007	1,875	\$ 584	8,540	\$ 5,625	—	\$ —	—	\$ —	—	\$ —	5,962	\$ —	\$ 81	\$ (3,315)	\$ 2,975
Issuance of common stock at \$0.00001 per share											290				—
Issuance of Series B convertible preferred stock at \$0.6625 per share, net of issuance costs of \$33			1,132	750											750
Issuance of Series C convertible preferred stock at \$1.2847 per share, net of issuance costs of \$88					11,676	14,912									14,912
Exercise of stock options											63		9		9
Stock-based compensation													208		208
Net loss														(14,501)	(14,501)
BALANCE — December 31, 2008	1,875	584	9,672	6,375	11,676	14,912	—	—	—	—	6,315	—	298	(17,816)	4,353
Issuance of Series D convertible preferred stock at \$0.235 per share, net of issuance costs of \$114							103,522	24,214							24,214
Issuance of Series D convertible preferred stock and beneficial conversion feature upon conversion of promissory notes							7,549	1,774							1,774
Exercise of stock options											338		31		31
Stock-based compensation													180		180
Net loss														(16,925)	(16,925)
BALANCE — December 31, 2009	1,875	584	9,672	6,375	11,676	14,912	111,071	25,988	—	—	6,653	—	509	(34,741)	13,627
Issuance of Series E convertible preferred stock at \$0.68 per share, net of issuance costs of \$145									67,471	45,737					45,737
Exercise of stock options											1,009		65		65
Stock-based compensation													829		829
Net loss														(21,777)	(21,777)
BALANCE — December 31, 2010	1,875	584	9,672	6,375	11,676	14,912	111,071	25,988	67,471	45,737	7,662	—	1,403	(56,518)	38,481
Exercise of stock options (unaudited)											83		10		10
Stock-based compensation (unaudited)													375		375
Net loss (unaudited)														(9,289)	(9,289)
BALANCE — March 31, 2011 (unaudited)	1,875	\$ 584	9,672	\$ 6,375	11,676	\$ 14,912	111,071	\$ 25,988	67,471	\$ 45,737	7,745	\$ —	\$ 1,788	\$ (65,807)	\$ 29,577

See notes to consolidated financial statements.

ENPHASE ENERGY, INC.
Consolidated Statements of Cash Flows
(in thousands)

	Year Ended December 31,			Three Months Ended March 31,	
	2008	2009	2010	2010	2011
	(unaudited)				
Cash flows from operating activities:					
Net loss	\$(14,501)	\$(16,925)	\$(21,777)	\$(3,799)	\$(9,289)
Adjustments to reconcile net loss to net cash used in operating activities:					
Depreciation and amortization	332	803	1,550	291	544
Net loss on disposal of assets	—	—	24	23	—
Provision for doubtful accounts	—	50	—	—	—
Noncash interest expense	—	274	90	—	30
Stock-based compensation	208	180	829	64	375
Change in fair value of convertible preferred stock warrant	—	—	189	—	58
Changes in operating assets and liabilities:					
Accounts receivable	(728)	(5,691)	(1,655)	(85)	184
Inventory	(695)	(700)	(3,038)	(2,867)	(1,297)
Prepaid expenses and other assets	(87)	(71)	(298)	(178)	(634)
Accounts payable, accrued and other liabilities	3,064	3,085	4,877	1,394	762
Deferred revenue	174	108	1,357	148	260
Net cash used in operating activities	<u>(12,233)</u>	<u>(18,887)</u>	<u>(17,852)</u>	<u>(5,009)</u>	<u>(9,007)</u>
Cash flows from investing activities:					
Purchases of property and equipment	(2,313)	(2,134)	(3,262)	(464)	(2,318)
Purchases of intangible assets	(160)	(36)	—	—	—
Deposits	(43)	(55)	—	—	—
Restricted cash	(103)	103	—	—	—
Net cash used in investing activities	<u>(2,619)</u>	<u>(2,122)</u>	<u>(3,262)</u>	<u>(464)</u>	<u>(2,318)</u>
Cash flows from financing activities:					
Proceeds from issuance of convertible preferred stock	15,750	24,328	45,882	20,977	—
Costs related to issuance of convertible preferred stock	(88)	(114)	(145)	(66)	—
Proceeds from issuance of convertible promissory notes	—	1,500	—	—	—
Borrowings under capital lease obligations	198	—	—	—	—
Principal payments under capital leases	—	(70)	(65)	(16)	(15)
Proceeds from term loans	571	—	7,000	7,000	2,000
Term loan issuance costs	—	—	(90)	(90)	(95)
Repayments of term loan	—	(160)	(178)	(42)	(48)
Proceeds from the exercise of stock options	9	31	61	12	14
Net cash provided by financing activities	<u>16,440</u>	<u>25,515</u>	<u>52,465</u>	<u>27,775</u>	<u>1,856</u>
Net increase (decrease) in cash and cash equivalents	1,588	4,506	31,351	22,302	(9,469)
Cash and cash equivalents — Beginning of period	2,548	4,136	8,642	8,642	39,993
Cash and cash equivalents — End of period	<u>\$ 4,136</u>	<u>\$ 8,642</u>	<u>\$ 39,993</u>	<u>\$ 30,944</u>	<u>\$ 30,524</u>
Supplemental disclosures of cash flow information:					
Cash paid for interest	<u>\$ 9</u>	<u>\$ 82</u>	<u>\$ 695</u>	<u>\$ 69</u>	<u>\$ 310</u>
Noncash financing and investing activities:					
Assets acquired under capital lease	<u>\$ 223</u>	<u>\$ —</u>	<u>\$ —</u>	<u>\$ —</u>	<u>\$ 295</u>
Purchases of property and equipment included in accounts payable	<u>\$ —</u>	<u>\$ —</u>	<u>\$ 521</u>	<u>\$ 610</u>	<u>\$ 1,414</u>
Conversion of promissory note to Series D preferred stock	<u>\$ —</u>	<u>\$ 1,500</u>	<u>\$ —</u>	<u>\$ —</u>	<u>\$ —</u>
Deferred offering costs not yet paid	<u>\$ —</u>	<u>\$ —</u>	<u>\$ —</u>	<u>\$ —</u>	<u>\$ 84</u>

See notes to consolidated financial statements.

ENPHASE ENERGY, INC.
NOTES TO CONSOLIDATED FINANCIAL STATEMENTS
YEARS ENDED DECEMBER 31, 2008, 2009 AND 2010 AND THE
THREE MONTHS ENDED MARCH 31, 2010 (UNAUDITED) AND MARCH 31, 2011 (UNAUDITED)

1. ORGANIZATION AND DESCRIPTION OF BUSINESS

Enphase Energy, Inc. and subsidiaries (the “Company”) designs, develops, and sells microinverter systems for the solar photovoltaic industry. The Company was incorporated in 2006 and began selling its products in June 2008. The Company’s microinverter system consists of (i) an Enphase microinverter that attaches to the racking beneath solar modules and converts direct current (DC) power to grid-compliant alternating current (AC) power; (ii) an Envoy communications gateway device that collects and transmits performance information from each solar module to our hosted data center; and (iii) the Enlighten web-based software platform that collects and processes this information to enable customers to monitor and manage their solar power systems. The Company sells microinverter systems primarily to distributors who resell them to solar installers. The Company also sells directly to large installers as well as through original equipment manufacturers (“OEMs”) and strategic partners.

2. SUMMARY OF SIGNIFICANT ACCOUNTING POLICIES

Principles of Consolidation—The accompanying consolidated financial statements include the accounts of the Company and its wholly owned subsidiaries. All intercompany balances and transactions have been eliminated in consolidation.

Unaudited Interim Financial Information—The accompanying interim consolidated balance sheet as of March 31, 2011, the interim consolidated statements of operations and cash flows for the three months ended March 31, 2010 and 2011, and the interim consolidated statement of shareholders’ equity for the three months ended March 31, 2011 are unaudited. The unaudited interim consolidated financial statements have been prepared on the same basis as the annual consolidated financial statements and, in the opinion of management, reflect all adjustments, which include only normal recurring adjustments, necessary to present fairly the Company’s financial position as of March 31, 2011 and its results of operations and cash flows for the three months ended March 31, 2010 and 2011. The financial data and other information disclosed in these notes to the consolidated financial statements related to the three month periods are unaudited. The results for the three months ended March 31, 2011 are not necessarily indicative of the results to be expected for the year ending December 31, 2011 or for any other interim period or other future year.

Unaudited Pro Forma Consolidated Balance Sheet—Upon the consummation of the initial public offering contemplated by the Company, all of the outstanding shares of convertible preferred stock will automatically convert into shares of common stock. In addition, all of the outstanding warrants to purchase convertible preferred stock will automatically convert into warrants to purchase common stock. The March 31, 2011 unaudited pro forma consolidated balance sheet data has been prepared assuming the conversion of the convertible preferred stock outstanding into 228,552,739 shares of common stock and the reclassification of the convertible preferred stock warrants from liabilities to stockholders’ equity.

Use of Estimates—The preparation of the Company’s consolidated financial statements in conformity with accounting principles generally accepted in the United States of America requires management to make estimates and assumptions that affect the reported amounts of assets and liabilities, disclosure of contingent assets and liabilities at the date of the financial statements and the reported amounts of income and expenses during the reporting period. These estimates are based on information available as of the date of the financial statements; therefore, actual results could differ materially from management’s estimates using different assumptions or under different conditions.

Risks and Uncertainties—The Company is subject to the risks inherent in a business with a limited operating history, including, but not limited to, new and rapidly evolving markets, reliance on additional equity

[Table of Contents](#)

or debt issuances at appropriate terms for funding of operations, advances and trends in the development of new technology and services, unfavorable economic and market conditions, competition from larger and more established companies, limited management resources and dependence on a limited number of contract manufacturers and suppliers. Failure by the Company to anticipate or to respond adequately to technological developments in its industry, changes in customer or supplier requirements, or changes in regulatory requirements or industry standards, could have a material adverse effect on the Company's business and operating results.

Revenue Recognition—The Company generates revenue from sales of its microinverter systems, which include microinverter units, an Envoy communications gateway device, and an Enlighten web-based monitoring service, to distributors, large installers, OEMs and strategic partners. Enlighten service revenue represented less than 1% of the total revenues for all periods presented.

Revenues from the sales of microinverters and communication gateways are recognized when: (i) persuasive evidence of an arrangement exists; (ii) delivery of the products has occurred in accordance with the terms of the sales agreement and title of and risk of loss have passed to the customer; (iii) the sale price is fixed or determinable; and (iv) collection is reasonably assured. Provisions for rebates, sales incentives, and discounts to customers are accounted for as reductions in revenue in the same period the related sales are recorded. Revenues from web-based monitoring services are recognized ratably over the term of the service period that is either one or five years. Customer billings and payments received in advance for services not yet rendered are deferred and recognized as revenue as the services are rendered.

Cost of Revenues—The Company includes the following in cost of revenues: product costs consisting of purchases from contract manufacturers and other suppliers, warranty, personnel and logistics costs, hosting services costs related to the Company's Enlighten service offering, and depreciation and amortization of test equipment.

Fair Value of Financial Instruments—The carrying amounts of cash and cash equivalents, accounts receivable and accounts payable approximate fair value due to their relatively short-term nature. The carrying amount of the Company's term loan approximates its fair value.

Fair Value Measurements—The accounting guidance defines fair value as the price that would be received from selling an asset or paid to transfer a liability in an orderly transaction between market participants at the measurement date. When determining the fair value measurements for assets and liabilities required to be recorded at fair value, the Company considers the principal or most advantageous market in which it would transact and considers assumptions that market participants would use when pricing the asset or liability, such as inherent risk, transfer restrictions, and risk of nonperformance.

The fair value hierarchy requires an entity to maximize the use of observable inputs and minimize the use of unobservable inputs when measuring fair value. An asset's or liability's categorization within the fair value hierarchy is based upon the lowest level of input that is significant to the fair value measurement. Three levels of inputs may be used to measure fair value:

- *Level 1* — Valuations based on quoted prices in active markets for identical assets or liabilities that the Company has the ability to access. Since valuations are based on quoted prices that are readily and regularly available in an active market, valuation of such assets or liabilities do not entail a significant degree of judgment.
- *Level 2* — Valuations based on one or more quoted prices in markets that are not active or for which all significant inputs are observable, either directly or indirectly.
- *Level 3* — Valuations based on inputs that are unobservable and significant to the overall fair value measurement.

[Table of Contents](#)

On a recurring basis, the Company measures its convertible preferred stock warrant liability at fair value based on Level 3 inputs, which requires a higher degree of judgment (see Note 9).

Cash and Cash Equivalents—The Company considers all highly liquid investments, such as certificates of deposit and money market instruments with maturities of three months or less at the time of acquisition to be cash equivalents. For all periods presented, the Company's cash balances consist of amounts held in interest-bearing money market accounts.

Allowances for Doubtful Accounts—The Company maintains allowances for doubtful accounts for uncollectible accounts receivable. The Company estimates anticipated losses from doubtful accounts based on days past due, collection history and other factors. The allowance for doubtful accounts was \$50,000, \$16,000 and \$13,000 (unaudited) at December 31, 2009, December 31, 2010 and March 31, 2011, respectively.

Inventory—Inventory is valued at the lower of cost or market. The Company determines cost on a first-in first-out basis. Certain factors could affect the realizable value of its inventory, including customer demand and market conditions. The Company considers historical usage, expected demand, anticipated sales price, effect of new product introductions, product obsolescence, customer concentrations, product merchantability and other factors when evaluating the value of inventory. Inventory write-downs are equal to the difference between the cost of inventories and their estimated fair market value. Inventory write-downs are recorded as cost of revenues in the accompanying consolidated statements of operations and were \$242,000, \$50,000 and \$108,000 in 2008, 2009 and 2010, respectively, and \$86,000 (unaudited) and zero (unaudited) in the three months ended March 31, 2010 and 2011, respectively.

Property and Equipment—Property and equipment are stated at cost less accumulated depreciation. Cost includes the price paid to acquire or construct the asset as well as any expenditure that substantially adds to the value of or significantly extends the useful life of an existing asset. Repair and maintenance costs are expensed as incurred. Depreciation and amortization is computed using the straight-line method over the estimated useful lives of the assets, which range from three to five years. Leasehold improvements are amortized over the shorter of the lease term or expected useful life of the improvements.

Capitalized Software Costs—Costs related to internal-use software are capitalized when preliminary development efforts are successfully completed, management has authorized and committed project funding, and it is probable that the project will be completed and the software will be used as intended. Such costs are amortized on a straight-line basis over their estimated useful lives. Costs incurred prior to meeting these criteria, together with costs incurred for training and maintenance, are expensed as incurred.

Indefinite-Lived Intangible Assets—Indefinite-lived intangible assets of \$266,000 are included in other assets at December 31, 2009, December 31, 2010 and \$286,000 (unaudited) at March 31, 2011, respectively. Such intangible assets consist of acquired intellectual property rights that currently have been determined to have indefinite lives and therefore are not amortized. The carrying values are assessed at least annually for impairment, or more frequently if events or changes in circumstances indicate that the carrying amount of such assets may not be recoverable.

Long-Lived Assets—The Company evaluates its long-lived assets for impairment whenever events or changes in circumstances indicate that the carrying amount of such assets may not be recoverable. Recoverability of assets to be held and used is measured by a comparison of the carrying amount of an asset to future undiscounted net cash flows expected to be generated by the asset. If such assets are considered to be impaired, the impairment to be recognized is measured by the amount by which the carrying amount of the assets exceeds the fair value of the assets.

Warranty Obligations—The Company's microinverters include a 15-year warranty. The Company maintains reserves to cover the expected costs that could result from these warranties. The potential liability is generally in the form of product replacement. Warranty reserves are computed on a per unit sold basis and are based on the Company's best estimate of such costs and are included in cost of revenues. The reserve for the

[Table of Contents](#)

related warranty expenses is based on various factors including historical warranty claims, assumptions about the frequency of warranty claims, and assumptions about the frequency of product failures, derived from results of accelerated lab testing, field monitoring and the Company's reliability estimates.

Product failure rates are estimated by using field monitoring of the actual failure rates of the microinverters the Company has shipped to date. The Company has established reliability as represented by a Mean Time Between Failures (MTBF) rate of approximately 0.3% per year. MTBF is the predicted elapsed time between inherent failures of a system during operation. In addition, due to the Company's limited operating history, it also utilizes third party data collected on similar equipment deployed in outdoor environments similar to those in which its microinverters are installed, as well as accelerated lab testing, which simulates the entire service life of the product in a short period of time using standard tests used by solar module vendors to determine the period over which the modules and microinverters may wear out. Replacement costs are updated periodically to reflect changes in the actual and estimated production costs for the Company's microinverters.

In addition, the Company supports its microinverters with its Entrust program. The Company reimburses the system owner for any lost energy for up to one month if a microinverter unit should fail, which is referred to as a "100% uptime guarantee". The Company estimates that its microinverter systems achieve system uptimes of over 99.8%. Historically, disbursements under the Entrust program have been insignificant, and therefore no accruals have been recorded for any such future obligations.

Research and Development Costs—The Company expenses research and development costs as incurred.

Stock-Based Compensation—Share-based payments are required to be recognized in the Company's consolidated statements of operations based on their fair values and the estimated number of shares expected to vest. The Company measures stock-based compensation expense for all share-based payment awards, including stock options made to employees and directors, based on the estimated fair values on the date of the grant. The fair value of each stock option granted is estimated using the Black-Scholes option valuation model. Stock-based compensation, net of estimated forfeitures, is recognized on a straight-line basis over the requisite service period, which is typically four years.

Comprehensive Loss—The Company has no components of other comprehensive income (loss); therefore, net loss equals comprehensive loss for all periods presented.

Convertible Preferred Stock Warrants—The Company records its freestanding warrants to purchase its convertible preferred stock as liabilities at their fair value upon issuance by utilizing a Monte Carlo simulation model that takes into account estimated probabilities of possible outcomes. The fair value of the warrants are subject to remeasurement at each balance sheet date with any change in value being reflected as other income (expense), net. Upon the earlier of the exercise of the warrants or the completion of a liquidation event, including the completion of an initial public offering, the liability will be reclassified to stockholders' equity, at which time it will no longer be subject to fair value accounting.

Income Taxes—The Company records income taxes using the asset and liability method, which requires the recognition of deferred tax assets and liabilities for the expected tax consequences of temporary differences between the tax bases of assets and liabilities for financial reporting purposes and amounts recognized for income tax purposes. In estimating future tax consequences, generally all expected future events other than enactments or changes in the tax law or rates are considered. Valuation allowances are provided when necessary to reduce deferred tax assets to the amount expected to be realized.

The Company operates in various tax jurisdictions and is subject to audit by various tax authorities. The Company follows accounting for uncertainty in income taxes which requires that the tax effects of a position be recognized only if it is "more likely than not" to be sustained based solely on its technical merits as of the reporting date. The Company considers many factors when evaluating and estimating its tax positions and tax benefits, which may require periodic adjustments and which may not accurately anticipate actual outcomes.

[Table of Contents](#)

Deferred Offering Costs—Deferred offering costs consisted primarily of direct incremental accounting and legal fees related to the Company's proposed initial public offering of its common stock. Approximately \$84,000 (unaudited) of deferred offering costs is included in other assets on the Company's consolidated balance sheet as of March 31, 2011. Upon completion of the initial public offering contemplated herein, these amounts will be offset against the proceeds of the offering. If the offering is terminated, the deferred offering costs will be expensed.

3. INVENTORY

Inventory as of December 31, 2009 and 2010 and March 31, 2011, consists of the following (in thousands):

	December 31,		March 31,
	2009	2010	2011 (unaudited)
Raw materials	\$ 35	\$ 761	\$ 1,682
Finished goods	1,448	3,760	4,136
Total inventory	<u>\$1,483</u>	<u>\$4,521</u>	<u>\$ 5,818</u>

4. PROPERTY AND EQUIPMENT, NET

As of December 31, 2009 and 2010 and March 31, 2011, property and equipment, net consists of the following (in thousands):

	Estimated Useful Life (Years)	December 31,		March 31,
		2009	2010	2011 (unaudited)
Equipment and machinery	5	\$ 3,120	\$ 4,777	\$ 5,466
Furniture and fixtures	3-5	302	530	530
Computer equipment	3	360	721	824
Capitalized software	1-3	894	1,709	1,820
Leasehold improvements	Shorter of lease term or useful life	60	483	483
Construction in progress		341	590	3,193
Total		5,077	8,810	12,316
Less accumulated depreciation and amortization		(1,183)	(2,707)	(3,250)
Property and equipment, net		<u>\$ 3,894</u>	<u>\$ 6,103</u>	<u>\$ 9,066</u>

Depreciation and amortization was \$332,000, \$803,000 and \$1,550,000 in 2008, 2009 and 2010, respectively, and \$291,000 (unaudited) and \$544,000 (unaudited) in the three months ended March 31, 2010 and 2011, respectively.

Included in property and equipment are assets acquired under capital lease obligations with an original cost of \$223,000 and \$199,000 and \$494,000 (unaudited) as of December 31, 2009, December 31, 2010 and March 31, 2011, respectively. Accumulated amortization was \$95,000, \$149,000 and \$164,000 (unaudited) as of December 31, 2009, December 31, 2010 and March 31, 2011, respectively.

Capitalized Internal Use Software—The Company capitalized \$237,000, \$815,000 and \$111,000 (unaudited) internal use software costs in fiscal 2009, 2010 and the three months ended March 31, 2011, respectively. The capitalized software costs are being amortized ratably over the estimated useful lives and are included within amortization expense in the amount of \$165,000, \$423,000 and \$157,000 (unaudited) for fiscal 2009, 2010 and the three months ended March 31, 2011, respectively.

5. WARRANTY OBLIGATIONS

Product warranty activity during 2009, 2010 and for the three months ended March 31, 2011 was as follows (in thousands):

	<u>December 31,</u>		<u>March 31,</u>
	<u>2009</u>	<u>2010</u>	<u>2011</u>
Balance, at beginning of year	\$ 424	\$ 1,087	\$ 2,668
Warranty expense	973	1,896	746
Settlements	<u>(310)</u>	<u>(315)</u>	<u>(104)</u>
Balance, at end of year	1,087	2,668	3,310
Less current portion		<u>(340)</u>	<u>(348)</u>
Long-term portion	<u>\$ 1,087</u>	<u>\$ 2,328</u>	<u>\$ 2,962</u>

6. LONG-TERM DEBT

The Company's long-term debt was comprised of the following at December 31, 2009 and 2010 and March 31, 2011 (in thousands):

	<u>December 31,</u>		<u>March 31,</u>
	<u>2009</u>	<u>2010</u>	<u>2011</u>
Total debt, net of unamortized discount of \$0, \$330 and \$587 at December 31, 2009, December 31, 2010 and March 31, 2011, respectively	\$ 411	\$ 6,903	\$ 8,581
Less current portion	<u>(178)</u>	<u>(2,567)</u>	<u>(2,484)</u>
Long-term portion	<u>\$ 233</u>	<u>\$ 4,336</u>	<u>\$ 6,097</u>

As of December 31, 2010, the amount of future principal repayments due on the total debt is as follows (in thousands):

2011	\$2,567
2012	2,800
2013	<u>1,866</u>
Total	<u>\$7,233</u>

Term Loans—On March 11, 2010, the Company entered into a venture loan agreement pursuant to which the Company borrowed \$7.0 million (“Original Term Loan”) to be used for general business purposes. The loan has an interest rate of 12.6% and a 42-month term, maturing on October 1, 2013. Monthly payments for the first 12 months will be interest only. Monthly payments beginning the thirteenth month will include interest and principal based on a 30-month remaining amortization period. The loan provides for penalties for early repayment, is secured by all assets of the Company except intellectual property and prohibits any dividend payments. As part of the agreement, the Company issued a warrant to purchase the Company's Series E convertible preferred stock. The fair value of the warrant of \$421,000 was recorded as a liability and a debt discount and is being amortized to interest expense over the loan term, or 42 months (see Note 9). As of March 31, 2011, the Original Term Loan had an outstanding principal balance of \$7.0 million.

On March 25, 2011, the Company entered into an amendment to the Original Term Loan to provide for an additional \$2.0 million term loan, which was fully drawn upon at execution of the amendment and an additional \$3.0 million term loan available to be drawn upon through July 31, 2011 (the “Additional Term Loans”), both of which mature on the first calendar day of the month that follows the 42-month anniversary of the date of advance. As of March 31, 2011, the \$2.0 million outstanding principal balance will mature on October 1, 2014.

[Table of Contents](#)

The Additional Term Loans have an interest rate of 10.75% and all borrowings have a 42-month term. Monthly payments for the first 12 months are interest only; subsequent monthly payments include interest and principal, based on a 30-month remaining amortization period. The other terms and conditions of the Original Term Loan remain substantially unchanged.

In connection with Additional Term Loans, the Company issued a warrant to purchase up to \$300,000 of the Company's convertible preferred stock. The warrant is exercisable until the later of (i) 10 years, or (ii) five years after an initial public offering as follows:

- If the Company completes an additional round of financing in convertible preferred stock of at least \$15.0 million in aggregate ("Qualified Financing") by April 8, 2011, the holder is entitled to purchase up to \$300,000 of the preferred stock sold in the Qualified Financing at an exercise price that equals the same price paid per share in the Qualified Financing.
- If the Company completes a Qualified Financing between April 8, 2011 and June 23, 2011, the holder is entitled to purchase 220,588 shares of Series E preferred stock at an exercise price of \$0.68 per share and up to \$150,000 of the preferred stock sold in the Qualified Financing at an exercise price that equals the same price paid per share in the Qualified Financing.
- If the Company does not complete a Qualified Financing by June 23, 2011, the holder is entitled to purchase 441,177 shares of the Company's Series E preferred stock at an exercise price of \$0.68 per share.

The fair value of the warrant of \$286,000 (unaudited) was recorded as a liability and a debt discount and is being amortized to interest expense over the loan term, or 42 months (see Note 9).

Revolving Line of Credit Facility—On January 19, 2010, the Company entered into a revolving line of credit agreement that provides for up to \$10.0 million in borrowings, based on a percentage of eligible receivables. The line of credit has a variable interest rate set at 1% above the bank's prime lending rate and expires January 19, 2012, with interest payable monthly and principal due at maturity. The loan is secured by all of the Company's assets except intellectual property. The agreement requires the Company to maintain minimum asset coverage ratios. As of December 31, 2010 and March 31, 2011, the Company was in compliance with this covenant and had not drawn any amounts under the facility.

On March 24, 2011, the Company amended the revolving line of credit facility to provide for an increase from \$10.0 million to a maximum of \$25.0 million revolving credit facility, including a \$5.0 million letter of credit subfacility, and extended the term of the credit commitments to March 24, 2013. Available borrowings are based on 80% of eligible receivables and 50% of inventory (up to \$10.0 million). The line of credit has a variable interest rate set at 1.25% above the bank's prime lending rate, with interest payable monthly and principal due on March 24, 2013. Any advance is collateralized by the underlying receivable or inventory and secured by all of the Company's assets except intellectual property. The agreement requires the Company to maintain minimum asset coverage and tangible net worth requirements. As of March 31, 2011, the Company has not drawn any amounts under the amended facility.

Convertible Promissory Notes—On March 31, 2009, the Company borrowed a total of \$1.5 million under five secured convertible promissory notes with several of its key investors. The notes carried an interest rate of 8% per year and were due and payable by December 31, 2009. On April 24, 2009, the notes, and accrued interest of \$8,000, were converted into 7,548,886 shares of Series D convertible preferred stock, representing a discount of approximately 15% to such investors (see Note 9). The resulting beneficial conversion feature of \$266,000 and the related accrued interest of \$8,000 were charged to interest expense.

Line of Credit Agreement—The Company entered into a line of credit agreement on December 15, 2008, which provided for borrowings of up to \$1 million. Amounts drawn under the line of credit are payable over 36 months (through December 15, 2011) with interest at a rate of approximately 14% annually. Specific assets

[Table of Contents](#)

were pledged as collateral for any amounts drawn under the line of credit. Any amounts drawn under the line of credit are subject to penalties for early repayment. The line of credit agreement does not include financial covenants or other material covenant requirements. As of December 31, 2010 and March 31, 2011, the line of credit had an outstanding principal balance of \$233,000 and \$168,000 (unaudited), respectively.

7. DEFINED CONTRIBUTION PLAN

The Company sponsors a defined contribution 401(k) savings plan covering substantially all of its U.S. employees, subject to certain eligibility requirements. Annually, the Company contributes 3% of an employee's salary earned in that given year, excluding commissions and bonuses, to the plan, regardless of whether the employee contributes. Any contributions made by the Company vest immediately to the participant. Costs related to the plan recognized by the Company for fiscal 2008, 2009, and 2010 were \$140,000, \$190,000, and \$388,000, respectively, and \$74,000 (unaudited) and \$130,000 (unaudited) for the three months ended March 31, 2010 and 2011, respectively.

8. COMMITMENTS AND CONTINGENCIES

Operating Leases—The Company leases its office facilities under an operating lease agreement that expires in 2013. The terms of the lease agreement provide for rental payments on a graduated basis. The Company recognizes rent expense on a straight-line basis over the lease period.

Rent expense for 2008, 2009 and 2010 was \$180,000, \$339,000 and \$582,000, respectively, and \$127,000 (unaudited) and \$208,000 (unaudited) for the three months ended March 31, 2010 and 2011, respectively.

The Company's minimum payments under noncancelable operating leases as of December 31, 2010, are as follows (in thousands):

2011	\$ 595
2012	619
2013	430
2014	2
Total minimum lease payments	<u>\$1,646</u>

Purchase Obligations—The Company has contractual obligations to purchase goods and services, which specify fixed or minimum quantities to be purchased; fixed, minimum, or variable price provisions; and the approximate timing of the transaction. Purchase obligations do not include contracts that may be canceled without penalty.

The Company utilizes third parties to manufacture its products. It acquires raw materials or other goods and services, including product components, by issuing to suppliers authorizations to purchase based on its projected demand and manufacturing needs.

As of December 31, 2010, the Company had noncancelable purchase obligations totaling approximately \$20.4 million.

Contingencies—From time to time, the Company may become involved in litigation. Management is not currently aware of any litigation matters or other contingencies that could have a material adverse effect on the financial position, results of operations, or cash flows of the Company.

9. STOCKHOLDERS' EQUITY AND WARRANTS

Series A, B, C, D and E Convertible Preferred Stock

Series A—In June 2006, the Company issued 1,875,000 shares of Series A convertible preferred stock at \$0.32 per share. The Company received proceeds of \$584,000, net of \$16,000 in issuance costs.

Series B—In February and March 2007, the Company issued 8,540,367 shares of Series B convertible preferred stock at \$0.6625 per share. The Company received proceeds of \$5,625,000, net of \$33,000 in issuance costs. In January 2008, the Company issued an additional 1,132,075 shares of Series B convertible preferred stock at \$0.6625 per share. The Company received proceeds of \$750,000. Primary investors in the Series B convertible preferred stock have the right to elect a member to the Company's Board of Directors.

Series C—In April 2008, the Company issued 11,675,878 shares of Series C convertible preferred stock at \$1.2847 per share. The Company received proceeds of \$14,912,000, net of \$88,000 in issuance costs. Primary investors in the Series C convertible preferred stock have the right to elect a member to the Company's Board of Directors.

Series D—In April and June 2009, the Company issued 103,522,345 shares of Series D convertible preferred stock at \$0.235 per share. The Company received proceeds of \$24,214,000, net of \$114,000 in issuance costs. Primary investors in the Series D preferred stock have the right to elect a member to the Company's Board of Directors. In April 2009, the Company issued 7,548,886 shares of Series D convertible preferred stock upon conversion of \$1,508,000 in principal and accrued interest under convertible promissory notes (see Note 6).

Series E—In March, April and May 2010, the Company authorized 75,000,000 shares and issued 67,471,300 shares of Series E convertible preferred stock at \$0.68 per share. The Company received proceeds of \$45,737,000, net of \$145,000 in issuance costs. Primary investors in the Series E convertible preferred stock have the right to elect two members to the Company's Board of Directors. On April 5, 2010, as part of the issuance of Series E convertible preferred stock, the Company's primary inventory manufacturer and supplier purchased 7,352,941 shares of the Company's Series E convertible preferred stock at \$0.68 per share or \$5 million in total. This represents an ownership interest in the Company of approximately 3%.

Voting—The holders of Series A, B, C, D and E convertible preferred stock are entitled to the number of votes equal to the number of shares of common stock into which the preferred stock is convertible, subject to certain limitations.

Dividends—Subject to the prior dividend rights of the Series E, D, C, and B convertible preferred stock, the holders of the Series A convertible preferred stock are entitled to receive, if, when and as declared by the Board of Directors, cash dividends at the rate of \$0.025 per share per annum (as adjusted for any stock splits, stock dividends, combinations or reorganizations). Such dividends are not mandatory or cumulative.

Subject to the prior dividend rights of the Series E, D, and C convertible preferred stock, the holders of the Series B convertible preferred stock are entitled to receive, if, when and as declared by the Board of Directors, cash dividends at the rate of \$0.053 per share per annum (as adjusted for any stock splits, stock dividends, combinations or reorganizations). Such dividends are not mandatory or cumulative.

Subject to the prior dividend rights of the Series E and D convertible preferred stock, the holders of the Series C convertible preferred stock are entitled to receive, if, when and as declared by the Board of Directors, cash dividends at the rate of \$0.103 per share per annum (as adjusted for any stock splits, stock dividends, combinations or reorganizations). Such dividends are not mandatory or cumulative.

Subject to the prior dividend rights of the Series E convertible preferred stock, the holders of the Series D convertible preferred stock are entitled to receive, if, when and as declared by the Board of Directors, cash dividends at the rate of \$0.0188 per share per annum (as adjusted for any stock splits, stock dividends, combinations or reorganizations). Such dividends are not mandatory or cumulative.

[Table of Contents](#)

The holders of the Series E convertible preferred stock are entitled to receive, if, when and as declared by the Board of Directors, cash dividends at the rate of \$0.0544 per share per annum (as adjusted for any stock splits, stock dividends, combinations or reorganizations). Such dividends are not mandatory or cumulative.

No dividends have been declared on the Series A, B, C, D or E convertible preferred stock.

Conversion—Each share of Series A, B, C, D and E convertible preferred stock is convertible at the option of the holder into the number of shares of common stock which results from dividing the original issue price for such series of convertible preferred stock by the conversion price for such series of convertible preferred stock.

The conversion price of each series of convertible preferred stock is as follows, subject to certain adjustments:

Series A	\$ 0.261
Series B	0.349
Series C	0.511
Series D	0.235
Series E	0.680

The Series A, B, C, D and E convertible preferred stock will be automatically converted into common stock: (a) immediately prior to the closing of a firmly underwritten public offering pursuant to the Securities Act of 1933, if aggregate gross proceeds to the Company in such offering equal or exceed \$30,000,000 and the public offering price is not less than \$0.68 per share (a “Qualified Public Offering”); and (b) upon receipt of the written consent of the holders of (i) 60% of the Series E convertible preferred stock voting as a separate series, with respect to the conversion of all outstanding shares of Series E convertible preferred stock, (ii) a majority of the Series E convertible preferred stock voting as a separate series in connection with an initial public offering that is not a Qualified Public Offering, or (iii) a majority of the holders of the Series A, B, C and D convertible preferred stock voting together on an as-converted basis with respect to the conversion of all outstanding shares of Series A, B, C and D convertible preferred stock.

Redemption—The Series A, B, C, D and E convertible preferred stock are not redeemable.

Liquidation Rights—In the event of any liquidation, dissolution, or winding-up of the Company, holders of Series E convertible preferred stock are entitled to receive an amount per share equal to the original issue price of the Series E convertible preferred stock plus all declared but unpaid dividends on the Series E convertible preferred stock, before any distributions of payments are made to the holders of any Series A, B, C, or D convertible preferred stock or common stock.

In the event of any liquidation, dissolution, or winding-up of the Company, and subject to payment in full of the liquidation preferences of the Series E convertible preferred stock, holders of Series D convertible preferred stock are entitled to receive an amount per share equal to two and one-half times the original issue price of the Series D convertible preferred stock plus all declared but unpaid dividends on the Series D convertible preferred stock, before any distributions of payments are made to the holders of any Series A, B, or C convertible preferred stock or common stock.

In the event of any liquidation, dissolution, or winding-up of the Company, and subject to payment in full of the liquidation preferences of the Series E and D convertible preferred stock, holders of Series C convertible preferred stock are entitled to receive an amount per share equal to the original issue price of the Series C convertible preferred stock plus all declared but unpaid dividends on the Series C convertible preferred stock, before any distributions of payments are made to the holders of any Series A or B convertible preferred stock or common stock.

In the event of any liquidation, dissolution, or winding-up of the Company, and subject to payment in full of the liquidation preferences of the Series E, D, and C convertible preferred stock, holders of Series B convertible

[Table of Contents](#)

preferred stock are entitled to receive an amount per share equal to the original issue price of the Series B convertible preferred stock plus all declared but unpaid dividends on the Series B convertible preferred stock, before any distributions of payments are made to the holders of any Series A convertible preferred stock or common stock.

In the event of any liquidation, dissolution, or winding-up of the Company, and subject to payment in full of the liquidation preferences of the Series E, D, C, and B convertible preferred stock, holders of Series A convertible preferred stock are entitled to receive an amount per share equal to the original issue price of the Series A convertible preferred stock plus all declared but unpaid dividends on the Series A convertible preferred stock, before any distributions of payments are made to the holders of any common stock.

The following table summarizes various terms of the different classes of convertible preferred stock and related warrants as of December 31, 2010 (in thousands, except per share data):

<u>Convertible Preferred Stock</u>	<u>Outstanding at December 31, 2010</u>	<u>Warrants Outstanding</u>	<u>Common Stock Equivalent Shares</u>	<u>Liquidation Preference per Share</u>	<u>Aggregate Liquidation Preference</u>	<u>Participating (per Share)</u>	<u>Annual Dividend per Share</u>
Series A	1,875		2,299	\$ 0.3200	\$ 600	No	0.0250
Series B	9,672		18,358	0.6625	6,408	Yes	0.0530
Series C	11,676	100	29,604	1.2847	15,000	Yes	0.1030
Series D	111,071		111,071	0.5875	65,254	No	0.0188
Series E	67,471	1,029	68,500	0.6800	45,880	Yes	0.0544
	<u>201,765</u>	<u>1,129</u>	<u>229,832</u>		<u>\$ 133,142</u>		

Warrants

Warrant to Purchase Series C Convertible Preferred Stock—In September 2008, the Company entered into a strategic collaboration agreement with a third party, under which the third party would test and evaluate the Enphase microinverter for European certification. As part of the agreement, the third party was granted a warrant to purchase 100,000 shares of Series C convertible preferred stock at a price of \$1.2847 per share. Exercisability of the warrant is contingent upon completion of several milestones, none of which have been completed. The warrant terminates upon the earlier of (i) an initial public offering, (ii) a sale of the Company, or (iii) six months after it becomes exercisable. The Company concluded that the warrant will not ultimately vest, as the Company has not been actively working with the third party. Accordingly, no expense has been recorded in the accompanying consolidated financial statements.

Warrant to Purchase Common Stock—On February 16, 2010, the Company entered into a supply and services agreement with a potential customer. As part of the agreement, the Company issued a warrant to purchase up to 100,000 common shares of the Company at a price of \$0.50 per share. The potential customer is required to meet certain minimum purchase volumes within 24 months of the contract date in order for the warrant to become exercisable. The agreement also allows the potential customer to participate in future equity financings by the Company (prior to an initial public offering), on the same terms and conditions as other investors. As of December 31, 2010, the Company has not recorded any reductions to revenue for the warrant issued as a sales incentive to the customer as the Company concluded it was not probable that the minimum purchase volumes would be reached. The Company will assess the probability of the achievement of the minimum purchase volumes at the end of each reporting period.

Warrant to Purchase Series E Convertible Preferred Stock—In connection with the March 2010 financing transaction (see Note 6), the Company issued a warrant to purchase 1,029,411 shares of the Company's Series E convertible preferred stock at a price of \$0.68 per share. The warrant is immediately exercisable and expires at the later of (i) 10 years, or (ii) five years after an initial public offering and includes provisions for down-round and anti-dilution protection. The Company accounts for the freestanding warrant as a derivative financial

[Table of Contents](#)

instrument liability. Changes in fair value are recognized as either a gain or loss in the consolidated statement of operations within other income (expense). In the event of a liquidation event, including the completion of an initial public offering, the warrant, if not exercised, will be converted into a warrant to purchase common stock, and accordingly, the liability will no longer be subject to fair value remeasurement and the liability will be reclassified to stockholders' equity. The fair value of the warrant at issuance and at December 31, 2010 was \$421,000 (recorded as debt discount and amortized to interest expense over the loan term) and \$610,000 (the increase in fair value recorded as other expense), respectively, and was calculated using the Monte Carlo simulation model with the following weighted-average assumptions:

Expected term (in years)	6.0
Expected volatility	60.5%
Annual risk-free rate of return	2.6%
Dividend yield	0%

Warrant to Purchase Convertible Preferred Stock—In connection with the March 25, 2011 Additional Term Loans (see Note 6), the Company issued a warrant to purchase up to \$300,000 of convertible preferred stock sold by the Company in a Qualified Financing by June 23, 2011, or if a Qualified Financing does not occur, 441,177 shares of the Company's Series E convertible preferred stock at an exercise price of \$0.68 per share. Both the specific number of shares that can be purchased and the exercise price will not be known prior to June 23, 2011. The warrant is immediately exercisable and expires at the later of i) 10 years, or ii) five years after an initial public offering and includes provisions for down-round and anti-dilution protection. The Company accounts for the freestanding warrant as a derivative financial instrument liability. Changes in fair value are recognized as either a gain or loss in the consolidated statement of operations within other income (expense). In the event of a liquidation event, including the completion of an initial public offering, the warrant, if not exercised, will be converted into a warrant to purchase common stock, and accordingly, the liability will no longer be subject to fair value remeasurement and the liability will be reclassified to stockholders' equity. The fair value of the warrant at issuance was \$286,000 (unaudited) (recorded as debt discount and amortized to interest expense over the loan term) and was calculated using the Monte Carlo simulation model with the following weighted-average assumptions:

Expected term (in years)	4.4
Expected volatility	73.1%
Annual risk-free rate of return	2.0%
Dividend yield	0%

Shares Reserved for Issuance

The Company has reserved the shares of common stock for future issuances as of December 31, 2010, as follows (in thousands):

Series A convertible preferred stock	2,299
Series B convertible preferred stock	18,358
Series C convertible preferred stock	29,353
Series D convertible preferred stock	111,071
Series E convertible preferred stock	67,471
Warrant to purchase Series C convertible preferred stock	251
Warrant to purchase Series E convertible preferred stock	1,029
Warrant to purchase common stock	100
Stock option plan:	
Options outstanding	52,682
Options available for future grants	5,347
Total common shares reserved for issuance	<u>287,961</u>

10. STOCK-BASED COMPENSATION

Stock Option Plan—Under the 2006 Equity Incentive Stock Option Plan (the “Plan”), equity awards permitted to be issued include incentive stock options (ISOs), nonstatutory stock options (NSOs), and restricted stock. ISOs may be granted only to employees (including officers and directors who are also employees) of the Company, and NSOs and restricted stock awards may be granted to employees, officers, directors and non-employees of the Company. At December 31, 2010 and March 31, 2011, the maximum aggregate number of shares that may be awarded is 60.4 million and 68.4 million (unaudited), respectively. ISOs and NSOs may be granted at a price per share not less than the fair market value at the date of grant. Options granted generally vest over a four-year period from the date of grant with a contractual term of up to 10 years. Common shares purchased under the Plan are subject to certain restrictions, including the right of first refusal by the Company for sale or transfer of these shares to outside parties. The Company’s right of first refusal terminates upon completion of an initial public offering of common stock.

A summary of the Company’s stock option activity for 2008, 2009, and 2010 and the three months ended March 31, 2011 is as follows (in thousands, except per share data):

	<u>Shares</u>	<u>Weighted-Average Exercise Price per Share</u>
Options outstanding—December 31, 2007	1,181	\$ 0.09
Granted (weighted-average fair value of \$0.15 per share)	2,164	0.23
Exercised	(63)	0.13
Canceled	(135)	0.23
Options outstanding—December 31, 2008	3,147	0.18
Granted (weighted-average fair value of \$0.02 per share)	30,254	0.03
Exercised	(338)	0.09
Canceled	(426)	0.11
Options outstanding—December 31, 2009	32,637	0.04
Granted (weighted-average fair value of \$0.19 per share)	23,139	0.17
Exercised	(1,009)	0.07
Canceled	(2,085)	0.06
Options outstanding—December 31, 2010	52,682	0.10
Granted (weighted-average fair value of \$0.33 per share) (unaudited)	2,631	0.28
Exercised (unaudited)	(83)	0.12
Canceled (unaudited)	(277)	0.18
Options outstanding—March 31, 2011 (unaudited)	<u>54,953</u>	0.11

At December 31, 2010 and March 31, 2011, there were 5.3 million and 11.0 million (unaudited) shares available for future grant issuance under the Plan.

[Table of Contents](#)

Information about currently outstanding and vested stock options as of December 31, 2010, is as follows:

Range of Exercise Prices	Options Outstanding			Options Exercisable	
	Number of Shares (in thousands)	Weighted-Average Remaining Life (in years)	Weighted-Average Exercise Price	Number of Shares (in thousands)	Weighted-Average Exercise Price
\$0.03–\$0.03	27,658	8.5	\$ 0.03	11,360	\$ 0.03
0.06–0.07	2,870	8.9	0.07	814	0.07
0.10–0.10	793	6.7	0.10	664	0.10
0.18–0.26	21,361	9.4	0.19	3,142	0.21
0.03–0.26	<u>52,682</u>	8.9	0.10	<u>15,980</u>	0.07

As of December 31, 2010, there were 50.9 million options outstanding that were vested, exercisable and expected to vest. Such options have a weighted-average exercise price of \$0.10 and a weighted-average remaining contractual term of 8.9 years. At December 31, 2010, the aggregate intrinsic value was \$5.8 million for the 16.0 million exercisable shares. For the 50.9 million options vested, exercisable and expected to vest, the aggregate intrinsic value was \$16.8 million. The intrinsic value is based on the Company's estimated common stock price of \$0.43 as of December 31, 2010, which would have been received by the option holders had all in-the-money options been exercised as of that date.

Stock-Based Compensation Expense—The fair value of options granted to employees for purposes of calculating stock-based compensation expense is estimated on the grant date using the Black-Scholes option valuation model. This valuation model requires the Company to make assumptions and judgments about the inputs used in the calculation, including the expected term (weighted-average period of time that the options granted are expected to be outstanding), the volatility of the Company's common stock, a risk-free interest rate, and expected dividend yield. The Company uses the simplified method to calculate the expected term, and volatility is based on an average of the historical volatilities of the common stock of several entities with characteristics similar to those of the Company. The risk-free rate is based on the U.S. Treasury yield curve in effect at the time of grant for periods corresponding with the expected life of the option. The Company's expected dividend yield input was zero as it has not historically paid, nor does it expect in the future to pay, cash dividends on its common stock.

The following table summarizes the components of total stock-based compensation expense included in the consolidated statement of operations for the periods presented (in thousands):

	Year Ended December 31,			Three Months Ended March 31,	
	2008	2009	2010	2010	2011
Cost of revenues	\$ 4	\$ 17	\$ 9	\$ 1	\$ 2
Research and development	27	62	286	25	140
Sales and marketing	7	36	256	14	137
General and administrative	170	65	278	24	96
Total stock-based compensation expense	<u>\$208</u>	<u>\$180</u>	<u>\$829</u>	<u>\$64</u>	<u>\$375</u>

[Table of Contents](#)

The fair value of each option granted during the periods presented was estimated on the date of grant using the Black-Scholes option-pricing model with the following weighted-average assumptions:

	Year Ended December 31,			Three Months Ended March 31,	
	2008	2009	2010	2010	2011
Expected term (in years)	5.6	5.9	6.0	6.0	6.0
Expected volatility	73.3%	76.4%	73.3%	75.6%	72.0%
Annual risk-free rate of return	3.0%	2.8%	2.2%	2.8%	2.4%
Dividend yield	0.0%	0.0%	0.0%	0.0%	0.0%

As of December 31, 2010 and March 31, 2011, there was approximately \$3.8 million and \$4.1 million (unaudited), respectively, of total unrecognized compensation cost related to unvested stock options, net of expected forfeitures, which is expected to be recognized over a weighted-average period of 3.3 years and 3.2 years (unaudited), respectively.

No income tax benefit has been recognized relating to stock-based compensation expense and no tax benefits have been realized from exercised stock options.

11. INCOME TAXES

The Company did not provide any current or deferred United States federal or state income tax provision or benefit for any of the years presented because it has experienced operating losses since inception.

A reconciliation of total income tax expense and the amount computed by applying the federal statutory income tax rate of 34% to loss before income taxes for 2008, 2009 and 2010 is as follows (in thousands):

	Year Ended December 31,		
	2008	2009	2010
Income tax benefit at statutory rate	\$(4,930)	\$(5,755)	\$(7,283)
Section 382 limitation		2,349	5,229
Change in valuation allowance	4,893	3,341	1,772
Stock-based compensation	27	55	138
Nondeductible/nontaxable items	10	10	144
Total tax expense	\$ —	\$ —	\$ —

A summary of significant components of the Company's deferred tax assets and liabilities, as of December 31, 2010 and 2009, is as follows (in thousands):

	December 31,	
	2009	2010
Net operating loss carryforwards	\$ 10,806	\$ 11,175
Accruals and reserves	658	1,711
Deferred tax assets	11,464	12,886
Less valuation allowance	(11,212)	(12,765)
Deferred tax assets	252	121
Deferred tax liability	(252)	(121)
Net deferred tax assets	\$ —	\$ —

[Table of Contents](#)

Due to the history of losses the Company has generated since inception, the Company believes that it is more-likely-than-not that all of the deferred tax assets will not be realized as of December 31, 2010. Therefore, the Company has recorded a full valuation allowance on its deferred tax assets.

The Company has net operating loss carryforwards for federal and California income tax purposes of approximately \$50.7 million and \$48.6 million, respectively, as of December 31, 2010. The federal and state net operating loss carryforwards, if not utilized, will expire beginning in 2026 and 2016, respectively. Utilization of the net operating loss carryforwards may be subject to a substantial annual limitation due to the ownership change limitations provided by the Internal Revenue Code of 1986, as amended, and similar state provisions. The annual limitation may result in the expiration of net operating losses before utilization.

The accounting for uncertain tax positions prescribes a recognition threshold and measurement attribute for the financial statement recognition and measurement of a tax position taken or expected to be taken in a tax return. The Company is required to recognize in the financial statements the impact of a tax position, if that position is more-likely-than-not of being sustained on audit, based on the technical merits of the position. There were no significant unrecognized tax benefits recorded upon adoption and there was no change to the unrecognized tax benefits during 2010.

The Company does not have any tax positions for which it is reasonably possible the total amount of gross unrecognized tax benefits will increase or decrease over the next year. The unrecognized tax benefits may increase or change during the next year for items that arise in the ordinary course of business. The Company records interest related to uncertain tax positions as interest and any penalties as other expense.

The Company's tax return years 2006 through 2010 remain open to examination by the major domestic taxing jurisdictions to which the Company is subject.

12. CONCENTRATIONS OF CREDIT RISK AND MAJOR CUSTOMERS

The Company is potentially subject to financial instrument concentration of credit risk through its cash equivalents and trade accounts receivable. The Company places its cash and cash equivalents with major financial institutions, which management assesses to be of high credit quality, in order to limit the exposure of each investment. Credit risk with respect to accounts receivable is relatively concentrated, as three customers represented 21%, 12% and 10% of the total accounts receivable balance as of December 31, 2009. At December 31, 2010, three customers accounted for approximately 14%, 13% and 10% of the total accounts receivable of the Company. In 2009, three customers, in the aggregate, accounted for approximately 39% of the Company's net sales. In 2010, two customers, in the aggregate, accounted for approximately 25% of the Company's net sales.

13. NET LOSS PER SHARE ATTRIBUTABLE TO COMMON STOCKHOLDERS

Basic and diluted net loss per share attributable to common stockholders are presented in conformity with the two-class method required for participating securities. Under the two-class method, net loss is allocated between common shares and other participating securities to the extent that the securities are required to share in the losses. The Company's convertible preferred stock does not meet the definition of a participating security in periods of net losses as the convertible preferred stockholders do not have a contractual obligation to share in the Company's losses. Accordingly, net losses are attributable to common stockholders.

Basic net loss per share attributable to common stockholders is calculated by dividing net loss attributable to common stockholders by the weighted average number of shares outstanding for the period.

Diluted net loss per share attributable to common stockholders is calculated by dividing net loss attributable to common stockholders by the weighted average number of common shares and potential dilutive common

[Table of Contents](#)

share equivalents outstanding during the period if the effect is dilutive. The Company's potential dilutive common share equivalents consist of incremental common shares issuable upon the exercise of options and warrants to purchase common shares and upon conversion of its convertible preferred stock.

The following table presents the potential common shares outstanding that were excluded from the computation of diluted net loss per share attributable to common stockholders for the periods presented because including them would have been antidilutive (in thousands):

	Year Ended December 31,			Three Months Ended March 31,	
	2008	2009	2010	2010	2011
				(unaudited)	
Convertible preferred stock	50,010	161,081	228,553	191,837	228,553
Stock options to purchase common stock	3,147	32,637	52,682	35,173	54,953
Convertible preferred stock warrants	251	251	1,280	1,280	1,722
Common stock warrants	—	—	100	100	100
	<u>53,408</u>	<u>193,969</u>	<u>282,615</u>	<u>228,390</u>	<u>285,328</u>

Unaudited Pro Forma Net Loss Per Share Attributable to Common Stockholders—Pro forma basic and diluted net loss per share attributable to common stockholders have been computed to give effect to the conversion of the Company's convertible preferred stock (using the if-converted method) into common stock and the conversion of all outstanding warrants to purchase convertible preferred stock into warrants to purchase common stock as though the conversion had occurred on the original dates of issuance.

The following table sets forth the computation of unaudited pro forma basic and diluted net loss per share attributable to common stockholders for the periods indicated:

	Year Ended December 31, 2010	Three Months Ended March 31, 2011
	(unaudited)	
	(in thousands, except per share data)	
Net loss	\$ (21,777)	\$ (9,289)
Pro forma amounts related to the fair value adjustments for warrants to purchase convertible preferred stock	189	58
Pro forma net loss used in computing pro forma basic and diluted net loss attributable to common stockholders	<u>\$ (21,588)</u>	<u>\$ (9,231)</u>
Pro forma net loss per share attributable to common stockholders, basic and diluted	<u>\$ (0.10)</u>	<u>\$ (0.04)</u>
Pro forma shares used in computing pro forma net loss per share attributable to common stockholders, basic and diluted	<u>216,536</u>	<u>236,248</u>

14. GEOGRAPHIC INFORMATION

The Company considers operating segments to be components of the Company in which separate financial information is available that is evaluated regularly by the Company's chief operating decision maker in deciding how to allocate resources and in assessing performance. The chief operating decision maker for the Company is the Chief Executive Officer. The Chief Executive Officer reviews financial information presented on a consolidated basis. The Company has one business activity, which entails the design, development, manufacture and sale of microinverter systems for the solar photovoltaic industry. There are no segment managers who are held accountable for operations, operating results or plans for levels or components below the consolidated unit level. Accordingly, the Company has determined that it has a single reporting segment and operating unit structure.

[Table of Contents](#)

The following tables present net revenues (based on the destination of the shipments) and long-lived assets by geographic region as of and for the periods presented, (in thousands):

Net Revenues

	Year Ended December 31,			Three Months Ended March 31,	
	2008	2009	2010	2010	2011
United States	\$1,668	\$19,530	\$53,383	\$10,770	\$15,736
Canada	—	664	8,278	817	2,333
Total	<u>\$1,668</u>	<u>\$20,194</u>	<u>\$61,661</u>	<u>\$11,587</u>	<u>\$18,069</u>

Long-Lived Assets

	December 31,			March 31,
	2008	2009	2010	2011
United States	\$2,312	\$3,232	\$5,330	\$ 7,567
Other	251	662	773	1,499
Total property and equipment, net	<u>\$2,563</u>	<u>\$3,894</u>	<u>\$6,103</u>	<u>\$ 9,066</u>

15. SUBSEQUENT EVENTS

On June 3, 2011, the Company entered into an agreement to lease approximately 96,000 square feet of office space for its new corporate headquarters. The Company's minimum obligation under this agreement is approximately \$13.5 million, payable over the ten-year term of the lease.

On June 13, 2011, the Company entered into a \$5 million equipment financing facility with Hercules Technology Growth Capital, Inc. The equipment financing facility has a variable interest rate set at the higher of 5.75% above the prime lending rate and 9.0% annually and expires July 1, 2014. This facility is secured by the financed equipment and restricts the Company's ability to pay dividends and take on certain types of additional liens. In connection with this facility, the Company issued warrants to purchase 229,591 shares of Series E convertible preferred stock at \$0.98 per share.

On June 14, 2011, the Company entered into a junior secured convertible loan facility with certain existing preferred stockholders that provides for up to \$50.0 million in borrowings ("Convertible Facility"). The Company borrowed \$12.5 million upon signing and may borrow up to an additional \$37.5 million prior to the earlier of (i) a subsequent equity financing of more than \$10.0 million or (ii) June 14, 2013, subject to the attainment of certain financial and operating conditions. The Convertible Facility bears interest at a rate of 9%, with interest payable in-kind at maturity which is the earlier to occur of the closing of (i) the initial public offering, (ii) a change in control or (iii) June 14, 2014. The initial \$12.5 million loan and accrued interest is repayable in cash or convertible into common stock at the holders' option at a price of \$0.98 per share. Additional borrowings and accrued interest are repayable at the holders' option as follows: up to 50% convertible into common stock at a price of \$0.98 per share and the remainder in cash. Because of the pay-in-kind feature, the Company expects to record interest expense in excess of the stated rate. The Convertible Facility is secured by all of the assets of the Company except intellectual property, prohibits dividend payments and restricts prepayment of the convertible portion of any outstanding loans under the facility. The agreement also requires the Company to meet certain minimum gross profit metrics and maximum warranty claim rates in order to be eligible for further advances under the facility. In connection with the Convertible Facility, the Company

[Table of Contents](#)

(i) issued 1,890,609 shares of common stock at \$0.58 per share and received proceeds of \$1,096,553, and (ii) issued warrants to purchase 695,586 shares of the Company's common stock at \$0.58 per share that are immediately exercisable with a contractual term of 5 years.

On June 14, 2011, the Company increased the number of authorized shares of common stock from 308,000,000 to 376,000,000.

The Company has evaluated subsequent events through June 15, 2011, the date on which these consolidated financial statements were available to be issued.

* * * * *

ENPHASE MICROINVERTER

Solar System Overview

Enphase offers microinverter technology for solar systems. Our microinverter combines innovations in power electronics, networking and web-based software, to make solar systems smarter and more efficient.

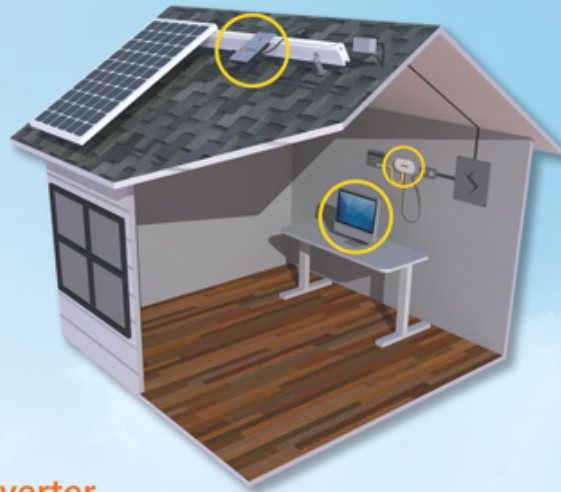

Our Microinverter

Our Enphase Microinverters are installed on the roof beneath the solar modules, and efficiently convert the power from each module into standard AC electricity.



Our Communications Gateway

Our Envoy Communications Gateway monitors the health and performance of each microinverter and solar module and sends this information to the system owner and installer via the Internet.



Our Software

Our Enlighten web-based software provides system owners and installers with detailed performance information and analytics about the solar system.





PART II
INFORMATION NOT REQUIRED IN THE PROSPECTUS

Item 13. Other Expenses of Issuance and Distribution.

The following table sets forth the costs and expenses, other than underwriting discounts and commissions, to be paid by the registrant in connection with the sale of the shares of common stock being registered hereby. All amounts are estimates except for the SEC registration fee and the FINRA filing fee.

	<u>Amount Paid or to be Paid</u>
SEC registration fee	\$ 11,610
FINRA filing fee	\$ 10,500
Initial NASDAQ Global Market listing fee	\$ 25,000
Printing and engraving	*
Legal fees and expenses	*
Accounting fees and expenses	*
Blue sky fees and expenses	*
Transfer agent and registrar fees and expenses	*
Miscellaneous	*
Total	<u>\$ *</u>

* To be filed by amendment.

Item 14. Indemnification of Directors and Officers.

We are incorporated under the laws of the State of Delaware. Section 145 of the Delaware General Corporation Law authorizes a court to award, or a corporation's board of directors to grant, indemnity to directors and officers under certain circumstances and subject to certain limitations. The terms of Section 145 of the Delaware General Corporation Law are sufficiently broad to permit indemnification under certain circumstances for liabilities, including reimbursement of expenses incurred, arising under the Securities Act.

As permitted by Section 102(b)(7) of the Delaware General Corporation Law, our certificate of incorporation includes a provision that eliminates, to the fullest extent permitted by law, the personal liability of a director for monetary damages resulting from breach of his fiduciary duty as a director.

As permitted by the Delaware General Corporation Law, our bylaws provide that:

- we are required to indemnify our directors and officers to the fullest extent permitted by the Delaware General Corporation Law;
- we may indemnify our other employees and agents as provided in indemnification contracts entered into between us and our employees and agents;
- we are required to advance expenses, as incurred, to our directors and officers in connection with a legal proceeding to the fullest extent permitted by the Delaware General Corporation Law; and
- the rights conferred in the bylaws are not exclusive.

Our policy is to enter into separate indemnification agreements with each of our directors and officers that provide the maximum indemnity allowed to directors and executive officers by Section 145 of the Delaware General Corporation Law and also provide for certain additional procedural protections. We currently carry liability insurance for our directors and officers. At present, there is no pending litigation or proceeding involving a director or officer of Enphase Energy, Inc. regarding which indemnification is sought, nor are we aware of any threatened litigation that may result in claims for indemnification.

[Table of Contents](#)

These indemnification provisions and the indemnification agreements entered into between us and our officers and directors may be sufficiently broad to permit indemnification of our officers and directors for liabilities (including reimbursement of expenses incurred) arising under the Securities Act.

The Underwriting Agreement to be filed as Exhibit 1.1 to this Registration Statement provides for indemnification by the underwriters of us, and our directors and officers for certain liabilities under the Securities Act, or otherwise.

Item 15. Recent Sales of Unregistered Securities.

Since January 1, 2008, we have made sales of the following unregistered securities:

(a) Issuances of Capital Stock

1. From January 1, 2008 through July 22, 2011, we issued and sold an aggregate of 5,300,887 shares of our common stock to our employees and consultants at prices ranging from \$0.03 to \$0.45 per share to an aggregate of 60 individuals, pursuant to exercises of options granted under our 2006 Equity Incentive Plan.
2. In January 2008, we issued and sold 1,132,075 shares of our Series B preferred stock to an accredited investor at \$0.6625 per share for an aggregate purchase price of \$750,000. Upon completion of this offering, these shares of Series B preferred stock will convert into 2,148,678 shares of our common stock.
3. In April 2008, we issued and sold an aggregate of 11,675,878 shares of our Series C preferred stock to 13 accredited investors at \$1.2847 per share for an aggregate purchase price of \$15,000,000. Upon completion of this offering, these shares of Series C preferred stock will convert into 29,353,159 shares of our common stock.
4. On September 16, 2008, we issued and sold 290,000 shares of our common stock to our Chief Executive Officer at a price of \$0.0001 per share pursuant to a restricted stock purchase agreement.
5. On March 31, 2009, we sold secured convertible promissory notes to purchase shares of our equity securities to five of our existing accredited investors for an aggregate purchase price of \$1.5 million. On April 24, 2009, the notes and accrued interest of \$7,890.42 were converted into 7,548,886 shares of Series D convertible preferred stock.
6. From April 2009 through June 2009, we issued and sold an aggregate of 111,071,231 shares of our Series D preferred stock to 34 accredited investors at \$0.235 per share for an aggregate purchase price of \$25,835,641. Upon completion of this offering, these shares of Series D preferred stock will convert into 111,071,231 shares of our common stock.
7. From March 2010 through May 2010, we issued and sold an aggregate of 67,471,300 shares of our Series E preferred stock to 27 accredited investors at \$0.68 per share for an aggregate purchase price of \$45,880,484. Upon completion of this offering, these shares of Series E preferred stock will convert into 67,471,300 shares of our common stock.

(b) Stock Option Grants and Warrant Issuances

1. From January 1, 2008 through July 22, 2011, we granted stock options to purchase an aggregate of 61,230,311 shares of our common stock at exercise prices ranging from \$0.03 to \$0.58 per share to a total of 236 employees, consultants and directors under our 2006 Equity Incentive Plan, of which options to purchase 3,626,866 shares were cancelled without being exercised.
2. In September 2008, in connection with the execution of a strategic collaboration agreement, we issued a warrant to purchase 100,000 shares of our Series C preferred stock to a potential distributor for an exercise price of \$1.2847 per share. This warrant becomes exercisable upon the completion of certain product qualification and certification milestones, and will expire upon the earlier of (i) a change in control of us, (ii) six months after becoming exercisable, or (iii) immediately prior to the closing of this offering.

Table of Contents

3. In March 2010, in connection with the execution of a supply and services agreement, we issued a warrant to purchase 100,000 shares of our common stock to a potential customer for an exercise price of \$0.50 per share. This warrant will expire on the earlier of December 31, 2012, or upon such customer's failure to meet such product purchasing milestones by (i) March 4, 2012, or (ii) an earlier change in control of Enphase.
4. In March 2010, in connection with our borrowing of an aggregate of \$7.0 million, we issued a warrant to purchase up to an aggregate of 1,029,412 shares of our Series E preferred stock to the lender for an exercise price of \$0.68 per share. This warrant is immediately exercisable and will expire upon the earlier of March 11, 2020, or five years after the closing of this offering.
5. In March 2011, in connection with our borrowing of an aggregate of \$5.0 million, we issued a warrant to purchase up to an aggregate amount of 441,177 shares of our Series E preferred stock to the lender for an exercise price of \$0.68 per share. This warrant is immediately exercisable and will expire upon the earlier of March 25, 2021, or five years after the closing of this offering.
6. In June 2011, in connection with our borrowing of an aggregate of \$5.0 million, we issued a warrant to purchase up to an aggregate amount of 229,591 shares of our Series E preferred stock to the lender for an exercise price of \$0.98 per share. This warrant is immediately exercisable and will expire upon the earlier of June 13, 2021, or five years after the closing of this offering.

(c) Issuances of Convertible Notes, Common Stock and Warrants

1. In June 2011, we entered into a junior secured convertible loan facility, or Convertible Facility, with 25 of our preferred stockholders, who are all accredited investors, that provides for up to \$50.0 million in borrowings. We borrowed \$12.5 million upon signing and may borrow up to an additional \$37.5 million prior to the earlier of (i) a subsequent equity financing of more than \$10.0 million or (ii) June 14, 2013, subject to the attainment of certain financial and operating conditions. The Convertible Facility bears interest at a rate of 9%, with interest payable in kind at maturity, which is the earlier to occur of the closing of (i) our initial public offering, (ii) a change of control or (iii) June 14, 2014. The initial \$12.5 million loan and accrued interest is repayable in cash or convertible into common stock at the holders' option at a price of \$0.98 per share. Additional borrowings and accrued interest are repayable at the holders' option as follows: up to 50% convertible into common stock at a price of \$0.98 per share and the remainder in cash. In consideration for the lenders' commitment under this facility, we issued 1,890,609 shares of common stock at a purchase price of \$0.58 per share to fourteen of the lenders and received proceeds of \$1,096,553 and issued to the remaining lenders warrants to purchase up to an aggregate amount of 695,586 shares of our common stock for an exercise price of \$0.58 per share. The warrants are immediately exercisable and will expire on June 14, 2016, subject to earlier termination upon an acquisition of us in which the consideration payable to holders of our common stock consists of cash and/or a class of securities that are registered under the Securities Exchange Act of 1934, as amended.

No underwriters were involved in the foregoing sales of securities.

The offers, sales and issuances of the securities described in Item 15(a)(1) and 15(b)(1) were deemed to be exempt from registration under the Securities Act under either (1) Rule 701 promulgated under the Securities Act as offers and sale of securities pursuant to certain compensatory benefit plans and contracts relating to compensation in compliance with Rule 701 or (2) Section 4(2) of the Securities Act as transactions by an issuer not involving any public offering. The recipients of securities in each of these transactions represented their intention to acquire the securities for investment only and not with view to or for sale in connection with any distribution thereof and appropriate legends were affixed to the share certificates and instruments issued in such transactions. All recipients had adequate access, through their relationships with us, to information about us.

Table of Contents

The offers, sales, and issuances of the securities described in Items 15(a)(2)-(5) and 15(b)(2)-(6) were deemed to be exempt from registration under the Securities Act in reliance on Section 4(2) of the Securities Act as transactions by an issuer not involving a public offering. The offers, sales and issuances of the securities described in Items 15(a)(6)-(7) and 15(c) were deemed to be exempt from registration under the Securities Act in reliance on Regulation D promulgated under the Securities Act, and in connection therewith we filed with the Securities and Exchange Commission: (i) a Form D on May 6, 2009, as subsequently amended on June 25, 2009 with respect to Item 15(a)(5); (ii) a Form D on April 7, 2010, as subsequently amended on June 4, 2010 with respect to Item 15(a)(6); and (iii) a Form D on June 24, 2011 with respect to Item 15(c). The recipients of securities in each of these transactions acquired the securities for investment only and not with a view to or for sale in connection with any distribution thereof, and appropriate legends were affixed to the securities issued in these transactions. Each of the recipients of securities in these transactions was an accredited or sophisticated person and had adequate access, through employment, business or other relationships, to information about us.

Item 16. Exhibits and Financial Statement Schedules.

(a) Exhibits.

<u>Exhibit No.</u>	<u>Description of Exhibit</u>
1.1*	Form of Underwriting Agreement.
3.1#	Amended and Restated Certificate of Incorporation of Enphase Energy, Inc., as amended, as currently in effect.
3.2*	Form of Amended and Restated Certificate of Incorporation of Enphase Energy, Inc. to be filed with the Delaware Secretary of State prior to closing of this offering to effect a reverse stock split.
3.3*	Form of Amended and Restated Certificate of Incorporation of Enphase Energy, Inc., to be effective immediately upon the closing of the offering.
3.4#	Bylaws of Enphase Energy, Inc., as amended, as currently in effect.
3.5*	Form of Amended and Restated Bylaws of Enphase Energy, Inc., to be effective upon the closing of this offering.
4.1*	Specimen Common Stock Certificate of Enphase Energy, Inc.
4.2	2010 Amended and Restated Investors' Rights Agreement by and between Enphase Energy, Inc. and the investors listed on Exhibit A thereto, dated March 15, 2010, as amended.
4.3	Common Stock Purchase Warrant, between the Company and MS Solar Solutions Corp, dated March 4, 2010.
4.4	Warrant to Purchase Shares of Series Preferred Stock, between the Company and Compass Horizon Funding Company LLC, dated March 11, 2010.
4.5	Warrant to Purchase Shares of Series Preferred Stock, between the Company and Horizon Technology Finance Corporation, dated March 25, 2011.
4.6	Warrant Agreement to Purchase Shares of Preferred Stock, between the Company and Hercules Technology Growth Capital, Inc., dated June 13, 2011.
5.1*	Opinion of Cooley LLP.
10.1*	Form of Indemnification Agreement entered into by and between Enphase Energy, Inc. and each of its directors and officers.
10.2#	2006 Equity Incentive Plan, as amended, and related documents.
10.3#	2011 Equity Incentive Plan and forms of agreement thereunder to be in effect upon the completion of this offering.
10.4#	2011 Employee Stock Purchase Plan to be in effect upon the completion of this offering.

Table of Contents

<u>Exhibit No.</u>	<u>Description of Exhibit</u>
10.5	Offer Letter by and between Enphase Energy, Inc. and Paul B. Nahi, dated January 1, 2007, as amended.
10.6	Offer Letter by and between Enphase Energy, Inc. and Sanjeev Kumar, dated November 12, 2009.
10.7	Employment Agreement by and between Enphase Energy, Inc. and Martin Fornage, dated March 21, 2006, as amended.
10.8	Offer Letter by and between Enphase Energy, Inc. and Jeff Loebbaka, dated April 19, 2010.
10.9	Employment Agreement by and between Enphase Energy, Inc. and Raghuvveer R. Belur, dated March 21, 2006, as amended.
10.10	Amended and Restated Venture Loan and Security Agreement by and between Enphase Energy, Inc., Horizon Technology Finance Corporation and Horizon Credit I LLC, dated March 25, 2011, as amended.
10.11	Amended and Restated Loan and Security Agreement by and between Enphase Energy, Inc., Bridge Bank, National Association and Comerica Bank, dated March 24, 2011.
10.12	Loan and Security Agreement by and between Enphase Energy, Inc. and Hercules Technology Growth Capital, Inc., dated June 13, 2011, as amended.
10.13#	Waterfront Office Building Full Service Lease by and between Enphase Energy, Inc. and Petaluma Theatre District, LLC, dated February 3, 2008, as amended.
10.14#	Redwood Business Park NNN Lease by and between Enphase Energy, Inc. and Sequoia Center LLC, dated June 3, 2011 (1400 North McDowell Boulevard).
10.15#	Redwood Business Park NNN Lease by and between Enphase Energy, Inc. and Sequoia Center LLC, dated June 3, 2011 (1420 North McDowell Boulevard).
10.16†*	Cooperation Agreement “AC cabling system for solar micro-inverter” by and among Enphase Energy, Inc., and Phoenix Contact GmbH & Co. KG and Phoenix Contact USA, Inc., dated December 7, 2010.
10.17†*	Flextronics Logistics Services Agreement by and between Enphase Energy, Inc. and Flextronics America, LLC, dated May 1, 2009.
10.18†*	Flextronics Manufacturing Services Agreement by and between Enphase Energy, Inc. and Flextronics Industrial, Ltd., dated March 1, 2009, as amended.
10.19†*	Master Development and Production Agreement by and between Enphase Energy, Inc. and Fujitsu Microelectronics America, Inc., dated August 19, 2009.
10.20†*	License and Technology Transfer Agreement by and between Enphase Energy, Inc. and Ariane Controls, Inc., dated December 21, 2007.
10.21*	Software License Agreement by and between PVI Solutions, Inc. (subsequently known as Enphase Energy, Inc.) and DCD, Digital Core Design, dated May 8, 2007, as amended.
10.22†	Subordinated Convertible Loan Facility and Security Agreement dated as of June 14, 2011 by and between KPCB Holdings, Inc. as nominee (as agent and lender), certain other lenders, and Enphase Energy, Inc., as amended.
10.23	Executive Severance Agreement by and between Enphase Energy, Inc. and Paul B. Nahi, dated June 14, 2011.
10.24	Change in Control and Severance Agreement by and between Enphase Energy, Inc. and Sanjeev Kumar, dated June 14, 2011.
10.25	Executive Severance Agreement by and between Enphase Energy, Inc. and Martin Fornage, dated June 14, 2011.

Table of Contents

<u>Exhibit No.</u>	<u>Description of Exhibit</u>
10.26	Change in Control and Severance Agreement by and between Enphase Energy, Inc. and Jeff Loebbaka, dated June 14, 2011.
10.27	Executive Severance Agreement by and between Enphase Energy, Inc. and Raghuvveer R. Belur, dated June 14, 2011.
10.28*	Non-employee Director Compensation Policy to be in effect upon completion of this offering.
10.29	Offer Letter by and between Enphase Energy, Inc. and Greg Steele, dated November 15, 2007.
10.30	Offer Letter by and between Enphase Energy, Inc. and Bill Rossi, dated August 23, 2010.
10.31	Offer Letter by and between Enphase Energy, Inc. and Dennis Hollenbeck, dated December 14, 2010.
10.32	Change in Control and Severance Agreement by and between Energy, Inc. and Greg Steele, dated June 14, 2011.
10.33	Change in Control and Severance Agreement by and between Energy, Inc. and Bill Rossi, dated June 14, 2011.
10.34	Change in Control and Severance Agreement by and between Energy, Inc. and Dennis Hollenbeck, dated June 14, 2011.
23.1*	Consent of Cooley LLP (included in Exhibit 5.1).
23.2	Consent of Deloitte & Touche LLP, independent registered public accounting firm.
24.1	Power of Attorney (see page II-8).

* To be filed by amendment.

† Material in the exhibit marked with a “****” has been omitted pursuant to a request for confidential treatment filed with the Securities and Exchange Commission. Omitted portions have been filed separately with the Securities and Exchange Commission.

Previously filed.

(b) Financial Statement Schedules.

Financial statement schedules have been omitted, as the information required to be set forth therein is included in the Consolidated Financial Statements or Notes thereto appearing in the prospectus made part of this registration statement.

Item 17. Undertakings.

The undersigned registrant hereby undertakes to provide to the underwriters at the closing, specified in the underwriting agreement, certificates in such denominations and registered in such names as required by the underwriters to permit prompt delivery to each purchaser.

Insofar as indemnification for liabilities arising under the Securities Act may be permitted to directors, officers and controlling persons of the registrant pursuant to the foregoing provisions, or otherwise, the undersigned has been advised that in the opinion of the Securities and Exchange Commission such indemnification is against public policy as expressed in the Act and is, therefore, unenforceable. In the event that a claim for indemnification against such liabilities (other than the payment by the registrant of expenses incurred or paid by a director, officer or controlling person of the registrant in the successful defense of any action, suit or proceeding) is asserted by such director, officer or controlling person in connection with the securities being registered, the registrant will, unless in the opinion of its counsel the matter has been settled by controlling precedent, submit to a court of appropriate jurisdiction the question whether such indemnification by it is against public policy as expressed in the Act and will be governed by the final adjudication of such issue.

[Table of Contents](#)

The undersigned registrant hereby undertakes that:

- (1) For purposes of determining any liability under the Securities Act, the information omitted from the form of prospectus filed as part of this registration statement in reliance upon Rule 430A and contained in a form of prospectus filed by the registrant pursuant to Rule 424(b)(1) or (4) or 497(h) under the Securities Act shall be deemed to be part of this registration statement as of the time it was declared effective.
- (2) For the purpose of determining any liability under the Securities Act, each post-effective amendment that contains a form of prospectus shall be deemed to be a new registration statement relating to the securities offered therein, and the offering of such securities at that time shall be deemed to be the initial bona fide offering thereof.

SIGNATURES

Pursuant to the requirements of the Securities Act of 1933, the registrant has duly caused this Amendment No. 1 to the registration statement to be signed on its behalf by the undersigned, thereunto duly authorized, in the City of Petaluma, State of California, on the 22nd day of July, 2011.

Enphase Energy, Inc.

By: /s/ Paul B. Nahi
Paul B. Nahi
President and Chief Executive Officer

POWER OF ATTORNEY

KNOW ALL MEN BY THESE PRESENTS, that each person whose signature appears below constitutes and appoints Paul B. Nahi and Sanjeev Kumar, jointly and severally, as his true and lawful attorneys-in-fact and agents, with full power of substitution and resubstitution, for him and in his name, place and stead, in any and all capacities, to sign the Registration Statement on Form S-1 of Enphase Energy, Inc. and any or all amendments (including post-effective amendments) thereto and any new registration statement with respect to the offering contemplated thereby filed pursuant to Rule 462(b) of the Securities Act, and to file the same, with all exhibits thereto, and other documents in connection therewith, with the Securities and Exchange Commission, granting unto said attorneys-in-fact and agents full power and authority to do and perform each and every act and thing requisite or necessary to be done in and about the premises hereby ratifying and confirming all that said attorneys-in-fact and agents, or his substitute or substitutes, may lawfully do or cause to be done by virtue hereof.

Pursuant to the requirements of the Securities Act of 1933, as amended, this Amendment No. 1 to the Registration Statement has been signed by the following persons in the capacities and on the dates indicated.

<u>Signature</u>	<u>Title</u>	<u>Date</u>
<u>/s/ Paul B. Nahi</u> Paul B. Nahi	President and Chief Executive Officer (Principal Executive Officer)	July 22, 2011
<u>/s/ Sanjeev Kumar</u> Sanjeev Kumar	Chief Financial Officer (Principal Financial and Accounting Officer)	July 22, 2011
<u>*</u> Raghuveer R. Belur	Director	July 22, 2011
<u>*</u> Neal Dempsey	Director	July 22, 2011
<u>*</u> Steven J. Gomo	Director	July 22, 2011
<u>*</u> Benjamin Kortlang	Director	July 22, 2011
<u>*</u> Jameson J. McJunkin	Director	July 22, 2011
<u>/s/ Chong Sup Park</u> Chong Sup Park	Director	July 22, 2011
<u>*</u> Robert Schwartz	Director	July 22, 2011
<u>*</u> Stoddard M. Wilson	Director	July 22, 2011
<u>*By /s/ Paul B. Nahi</u> Paul B. Nahi Attorney-in-Fact		

EXHIBIT INDEX

<u>Exhibit No.</u>	<u>Description of Exhibit</u>
1.1*	Form of Underwriting Agreement.
3.1#	Amended and Restated Certificate of Incorporation of Enphase Energy, Inc., as amended, as currently in effect.
3.2*	Form of Amended and Restated Certificate of Incorporation of Enphase Energy, Inc. to be filed with the Delaware Secretary of State prior to closing of this offering to effect a reverse stock split.
3.3*	Form of Amended and Restated Certificate of Incorporation of Enphase Energy, Inc., to be effective immediately upon the closing of the offering.
3.4#	Bylaws of Enphase Energy, Inc., as amended, as currently in effect.
3.5*	Form of Amended and Restated Bylaws of Enphase Energy, Inc., to be effective upon the closing of this offering.
4.1*	Specimen Common Stock Certificate of Enphase Energy, Inc.
4.2	2010 Amended and Restated Investors' Rights Agreement by and between Enphase Energy, Inc. and the investors listed on Exhibit A thereto, dated March 15, 2010, as amended.
4.3	Common Stock Purchase Warrant, between the Company and MS Solar Solutions Corp, dated March 4, 2010.
4.4	Warrant to Purchase Shares of Series Preferred Stock, between the Company and Compass Horizon Funding Company LLC, dated March 11, 2010.
4.5	Warrant to Purchase Shares of Series Preferred Stock, between the Company and Horizon Technology Finance Corporation, dated March 25, 2011.
4.6	Warrant Agreement to Purchase Shares of Preferred Stock, between the Company and Hercules Technology Growth Capital, Inc., dated June 13, 2011.
5.1*	Opinion of Cooley LLP.
10.1*	Form of Indemnification Agreement entered into by and between Enphase Energy, Inc. and each of its directors and officers.
10.2#	2006 Equity Incentive Plan, as amended, and related documents.
10.3#	2011 Equity Incentive Plan and forms of agreement thereunder to be in effect upon the completion of this offering.
10.4#	2011 Employee Stock Purchase Plan to be in effect upon the completion of this offering.
10.5	Offer Letter by and between Enphase Energy, Inc. and Paul B. Nahi, dated January 1, 2007, as amended.
10.6	Offer Letter by and between Enphase Energy, Inc. and Sanjeev Kumar, dated November 12, 2009.
10.7	Employment Agreement by and between Enphase Energy, Inc. and Martin Fornage, dated March 21, 2006, as amended.
10.8	Offer Letter by and between Enphase Energy, Inc. and Jeff Loebbaka, dated April 19, 2010.
10.9	Employment Agreement by and between Enphase Energy, Inc. and Raghuvveer R. Belur, dated March 21, 2006, as amended.
10.10	Amended and Restated Venture Loan and Security Agreement by and between Enphase Energy, Inc., Horizon Technology Finance Corporation and Horizon Credit I LLC, dated March 25, 2011, as amended.
10.11	Amended and Restated Loan and Security Agreement by and between Enphase Energy, Inc., Bridge Bank, National Association and Comerica Bank, dated March 24, 2011.

Table of Contents

<u>Exhibit No.</u>	<u>Description of Exhibit</u>
10.12	Loan and Security Agreement by and between Enphase Energy, Inc. and Hercules Technology Growth Capital, Inc., dated June 13, 2011, as amended.
10.13#	Waterfront Office Building Full Service Lease by and between Enphase Energy, Inc. and Petaluma Theatre District, LLC, dated February 3, 2008, as amended.
10.14#	Redwood Business Park NNN Lease by and between Enphase Energy, Inc. and Sequoia Center LLC, dated June 3, 2011 (1400 North McDowell Boulevard).
10.15#	Redwood Business Park NNN Lease by and between Enphase Energy, Inc. and Sequoia Center LLC, dated June 3, 2011 (1420 North McDowell Boulevard).
10.16†*	Cooperation Agreement “AC cabling system for solar micro-inverter” by and among Enphase Energy, Inc., and Phoenix Contact GmbH & Co. KG and Phoenix Contact USA, Inc., dated December 7, 2010.
10.17†*	Flextronics Logistics Services Agreement by and between Enphase Energy, Inc. and Flextronics America, LLC, dated May 1, 2009.
10.18†*	Flextronics Manufacturing Services Agreement by and between Enphase Energy, Inc. and Flextronics Industrial, Ltd., dated March 1, 2009, as amended.
10.19†*	Master Development and Production Agreement by and between Enphase Energy, Inc. and Fujitsu Microelectronics America, Inc., dated August 19, 2009.
10.20†*	License and Technology Transfer Agreement by and between Enphase Energy, Inc. and Ariane Controls, Inc., dated December 21, 2007.
10.21*	Software License Agreement by and between PVI Solutions, Inc. (subsequently known as Enphase Energy, Inc.) and DCD, Digital Core Design, dated May 8, 2007, as amended.
10.22†	Subordinated Convertible Loan Facility and Security Agreement dated as of June 14, 2011 by and between KPCB Holdings, Inc. as nominee (as agent and lender), certain other lenders, and Enphase Energy, Inc., as amended.
10.23	Executive Severance Agreement by and between Enphase Energy, Inc. and Paul B. Nahi, dated June 14, 2011.
10.24	Change in Control and Severance Agreement by and between Enphase Energy, Inc. and Sanjeev Kumar, dated June 14, 2011.
10.25	Executive Severance Agreement by and between Enphase Energy, Inc. and Martin Fornage, dated June 14, 2011.
10.26	Change in Control and Severance Agreement by and between Enphase Energy, Inc. and Jeff Loebbaka, dated June 14, 2011.
10.27	Executive Severance Agreement by and between Enphase Energy, Inc. and Raghuvveer R. Belur, dated June 14, 2011.
10.28*	Non-employee Director Compensation Policy to be in effect upon completion of this offering.
10.29	Offer Letter by and between Enphase Energy, Inc. and Greg Steele, dated November 15, 2007.
10.30	Offer Letter by and between Enphase Energy, Inc. and Bill Rossi, dated August 23, 2010.
10.31	Offer Letter by and between Enphase Energy, Inc. and Dennis Hollenbeck, dated December 14, 2010.
10.32	Change in Control and Severance Agreement by and between Energy, Inc. and Greg Steele, dated June 14, 2011.
10.33	Change in Control and Severance Agreement by and between Energy, Inc. and Bill Rossi, dated June 14, 2011.

Table of Contents

<u>Exhibit No.</u>	<u>Description of Exhibit</u>
10.34	Change in Control and Severance Agreement by and between Energy, Inc. and Dennis Hollenbeck, dated June 14, 2011.
23.1*	Consent of Cooley LLP (included in Exhibit 5.1).
23.2	Consent of Deloitte & Touche LLP, independent registered public accounting firm.
24.1	Power of Attorney (see page II-8).
<hr/>	
*	To be filed by amendment.
†	Material in the exhibit marked with a “****” has been omitted pursuant to a request for confidential treatment filed with the Securities and Exchange Commission. Omitted portions have been filed separately with the Securities and Exchange Commission.
#	Previously filed.

ENPHASE ENERGY, INC.

AMENDED AND RESTATED INVESTORS' RIGHTS AGREEMENT

March 15, 2010

AMENDED AND RESTATED INVESTORS' RIGHTS AGREEMENT

This Amended and Restated Investors' Rights Agreement (the "Agreement") is made as of March 15, 2010, by and among Enphase Energy, Inc., a Delaware corporation (the "Company"), and the investors listed on Exhibit A hereto, each of which is herein referred to as an "Investor" and all of whom herein collectively are referred to as "Investors."

RECITALS

A. Certain of the Investors (the "Prior Investors") are holders of outstanding shares of the Company's Series A Preferred Stock (the "Series A Preferred Stock"), Series B Preferred Stock (the "Series B Preferred Stock"), Series C Preferred Stock (the "Series C Preferred Stock") and/or Series D Preferred Stock (the "Series D Preferred Stock") and have been granted certain information and registration rights and rights of first refusal under an Amended and Restated Investors' Rights Agreement by and among the Company and the Prior Investors dated April 24, 2009, as amended on June 23, 2009 (the "Prior Rights Agreement").

B. Certain Investors (the "Series E Investors") have agreed to purchase shares of the Company's Series E Preferred Stock (the "Series E Preferred Stock") pursuant to a certain Series E Preferred Stock Purchase Agreement by and among the Company and such Series E Investors dated as of even date herewith, as amended from time to time (the "Series E Agreement"). The Series E Agreement provides that, as a condition to the Series E Investors' purchase of Series E Preferred Stock thereunder, the Company will enter into this Agreement, and the Series E Investors will be granted the rights set forth herein.

C. The Company and the Investors (including the Prior Investors) desire to enter into this Agreement in order to amend, restate and replace their rights and obligations under the Prior Rights Agreement with the rights and obligations set forth in this Agreement. Section 4.3 of the Prior Rights Agreement provides that the Prior Rights Agreement may be amended by at least 60% of the outstanding shares of Preferred Stock held by the Investors, voting together as a single class, and the undersigned parties to this Agreement hold the requisite number of shares to amend the Prior Rights Agreement.

AGREEMENT

The parties hereby agree as follows:

1. **Registration Rights**. The Company and the Investors covenant and agree as follows:

1.1. **Definitions**. For purposes of this Section 1:

(a) The term "Affiliated Fund" means, with respect to a Holder that is a limited liability company or a limited liability partnership, a fund or entity managed by the same manager or managing member or general partner or management company or by an entity

controlling, controlled by, or under common control with such manager or managing member or general partner or management company;

(b) The term “Board” means the Company’s Board of Directors.

(c) The term “Exchange Act” means the Securities Exchange Act of 1934, as amended (and any successor thereto) and the rules and regulations promulgated thereunder;

(d) The term “Form S-3” means such form under the Securities Act as in effect on the date hereof or any successor form under the Securities Act;

(e) The term “Holder” means any person owning or having the right to acquire Registrable Securities or any assignee thereof in accordance with Section 1.12 of this Agreement;

(f) The term “Horizon Warrant” means that certain warrant to purchase Preferred Stock of the Company, dated March 11, 2010 issued by the Company to Compass Horizon Funding Company LLC (“Horizon”) pursuant to the Venture Loan and Security Agreement by and between the Company and Horizon, dated March 11, 2010.

(g) The term “Major Investor” means any person who holds at least 1,000,000 shares of Preferred Stock or the Common Stock issued upon conversion thereof (subject to adjustment for stock splits, stock dividends, combinations, reclassifications or the like). A Major Investor includes any general partners, managing members and affiliates of a Major Investor, including Affiliated Funds;

(h) The term “Preferred Stock” means the Preferred Stock, \$0.00001 par value, of the Company.

(i) The term “Qualified IPO” means a firm commitment underwritten public offering by the Company of shares of its Common Stock in connection with which all the then-outstanding shares of Preferred Stock are converted into shares of Common Stock pursuant to the Company’s Amended and Restated Certificate of Incorporation as it may be amended from time to time;

(j) The terms “register,” “registered,” and “registration” refer to a registration effected by preparing and filing a registration statement or similar document in compliance with the Securities Act, and the declaration or ordering of effectiveness of such registration statement or document;

(k) The term “Registrable Securities” means (i) the shares of Common Stock issuable or issued upon conversion of any shares of the Company’s Preferred Stock, including Preferred Stock issuable upon exercise of warrants then outstanding; and (ii) any other shares of Common Stock of the Company issued (or issuable upon the conversion or exercise of any warrant, right or other security) to the holders of the shares listed in (i) above; excluding in all cases any Registrable Securities sold by a person in a transaction in which such person’s rights under this Agreement are not assigned. Notwithstanding the foregoing, Common Stock or

other securities shall only be treated as Registrable Securities if and so long as: (A) they have not been sold to or through a broker or dealer or underwriter in a public distribution or a public securities transaction, (B) they have not been sold in a transaction exempt from the registration and prospectus delivery requirements of the Securities Act under Section 4(1) thereof so that all transfer restrictions, and restrictive legends with respect thereto, if any, are removed upon the consummation of such sale, or (C) the rights of the Holder thereof have not been terminated in accordance with Section 1.15 below. Notwithstanding the foregoing, the shares of Common Stock issuable or issued upon conversion of any shares of the Company's Preferred Stock issuable upon exercise of the Horizon Warrant shall not be deemed Registrable Securities for purposes of Section 1.2;

(l) The number of shares of "Registrable Securities then outstanding" shall be determined by the number of shares of Common Stock outstanding which are, and the number of shares of Common Stock issuable pursuant to then exercisable or convertible securities which are, Registrable Securities;

(m) The "Restated Certificate" means the Company's Amended and Restated Certificate of Incorporation;

(n) The term "SEC" means the Securities and Exchange Commission;

(o) The term "Securities Act" means the Securities Act of 1933, as amended (and any successor thereto), and the rules and regulations promulgated thereunder; and

(p) The term "Significant Holder" means any person who holds at least 300,000 shares of Common Stock issued or issuable upon conversion of Preferred Stock (subject to adjustment for stock splits, stock dividends, combinations, reclassifications or the like). A Significant Holder includes any general partners, managing members and affiliates of a Significant Holder, including Affiliated Funds.

1.2. Request for Registration.

(a) If the Company shall receive at any time after six (6) months after the effective date of the Company's initial public offering covering the offer and sale of Common Stock of the Company (the "IPO") a written request from the Holders of at least a majority of the Registrable Securities then outstanding (the "Initiating Holders") that the Company file a registration statement under the Securities Act covering the registration of at least thirty percent (30%) of the Registrable Securities with an anticipated aggregate offering price of at least \$5,000,000, then the Company shall promptly give written notice of such request to all Holders and shall, subject to the limitations of subsections 1.2(b)-(d), as soon as practicable, use its reasonable best efforts to effect a registration statement under the Securities Act covering all Registrable Securities which the Holders request to be registered within 15 business days of the mailing of such notice by the Company.

(b) If the Initiating Holders intend to distribute the Registrable Securities covered by their request by means of an underwriting, they shall so advise the Company as a part of their request and the Company shall include such information in the written notice referred to in subsection 1.2(a). The underwriter will be selected by the Initiating

Holders and shall be reasonably acceptable to the Company. In such event, the right of any Holder to include such Holder's Registrable Securities in such registration shall be conditioned upon such Holder's participation in such underwriting and the inclusion of such Holder's Registrable Securities in the underwriting (unless otherwise mutually agreed by a majority in interest of the Initiating Holders and such Holder) to the extent provided herein. The Company and all Holders proposing to distribute their securities through such underwriting shall enter into an underwriting agreement in customary form with the underwriter or underwriters selected for such underwriting; provided, however, that such agreement shall not provide for indemnification or contribution obligations on the part of the Holders materially greater than the obligations of the Holders under Section 1.10(b) hereof. Notwithstanding any other provision of this Section 1.2, if the underwriter advises the Company in good faith that marketing factors require a limitation of the number of shares to be underwritten, then the Company shall so advise all Holders of Registrable Securities which would otherwise be underwritten pursuant hereto, and the maximum number of shares of Registrable Securities that may be included in the underwriting shall be allocated among all participating Holders thereof, including the Initiating Holders, in proportion (as nearly as practicable) to the amount of Registrable Securities of the Company owned by each participating Holder. In no event shall any Registrable Securities be excluded from such underwriting unless all other securities are first excluded from such offering. Any Registrable Securities excluded from or withdrawn from such underwriting shall be withdrawn from registration.

(c) Notwithstanding the foregoing, if the Company shall furnish to Holders requesting a registration statement pursuant to this Section 1.2, a certificate signed by the President of the Company stating that in the good faith judgment of the Board, it would be seriously detrimental to the Company and its stockholders for such registration statement to be filed, the Company shall have the right to defer such filing for a period of not more than 90 days after receipt of the request of the Initiating Holders; provided, however, that the Company may not utilize this right more than once in any twelve-month period; provided, further that the Company shall not register any securities for the account of itself or any other stockholder during such 90-day period (other than in a Qualified IPO, a registration relating solely to the sale of securities of participants in a Company stock plan, a registration relating to a corporate reorganization or transaction under Rule 145 of the Securities Act).

(d) In addition, the Company shall not be obligated to effect, or to take any action to effect, any registration pursuant to this Section 1.2:

(i) After the Company has effected two registrations pursuant to this Section 1.2 and such registrations have been declared or ordered effective;

(ii) During the period starting with the date 90 days prior to the Company's good faith estimate of the date of filing of, and ending on a date 90 days after the effective date of; a registration subject to Section 1.3 hereof; provided that the Company is actively employing in good faith all commercially reasonable efforts to cause such registration statement to become effective; and provided, further that the Company may only delay an offering pursuant to this Section 1.2(d) for a period of not more than 90 days if a filing of a registration statement in connection with such registration is not made during such period and the Company may only exercise this right once in any twelve-month period; or

(iii) In any jurisdiction in which the Company would be required to qualify to do business or execute a general consent to service of process in effecting such registration, unless the Company is already qualified to do business or subject to service of process in such jurisdiction.

1.3. Company Registration.

(a) If (but without any obligation to do so) the Company proposes to register (including for this purpose a registration effected by the Company for stockholders other than the Holders) any of its stock under the Securities Act in connection with the public offering of such securities solely for cash (other than a registration relating solely to the sale of securities to participants in a Company stock plan or a transaction covered by Rule 145 under the Securities Act, or any registration on any form which does not include substantially the same information as would be required to be included in a registration statement covering the sale of the Registrable Securities), the Company shall, at such time, promptly give each Holder written notice of such registration (which notice shall include a list of the jurisdictions in which the Company intends to attempt to qualify such securities under the applicable blue sky or other state securities laws and shall specify if such registration is for a registered public offering involving an underwriting). Upon the written request of any Holder given within 20 days after mailing of such notice by the Company in accordance with Section 4.4, the Company shall, subject to the provisions of Section 1.8, include in the related registration statement all of the Registrable Securities that each such Holder has requested to be registered.

(b) The Company shall have the right to terminate or withdraw any registration initiated by it under this Section 1.3 prior to the effectiveness of such registration whether or not any Holder has elected to include securities in such registration. The expenses of such registration shall be borne by the Company, in accordance with Section 1.7 hereof.

(c) If the registration of which the Company gives notice is for a registered public offering involving an underwriting, the Company shall so advise the Holders as a part of the written notice given pursuant to Section 1.3(a) hereof. In such event, the right of any Holder to registration pursuant to this Section 1.3 shall be conditioned upon such Holder's participation in such underwriting and the inclusion of such Holder's Registrable Securities in the underwriting to the extent provided herein. All Holders proposing to distribute their securities through such underwriting shall (together with the Company and the other stockholders distributing their securities through such underwriting) enter into an underwriting agreement in customary form with the representative of the underwriter or underwriters selected by the Company.

(d) Notwithstanding any other provision of this Section 1.3, if the representative of the underwriters advises the Company in writing that marketing factors require a limitation on the number of shares to be underwritten, the Company may limit the number of Registrable Securities to be included in the registration and underwriting; provided, however, that (i) in no event shall any Registrable Securities be excluded from such underwriting unless all other securities are first excluded, and (ii) the number of Registrable Securities to be included in the registration and underwriting shall not be reduced to less than thirty percent (30%) of the total amount of securities included in such registration, unless such registration is the IPO, in

which case all of the Registrable Securities may be excluded from such registration if requested by the underwriters. The Company shall so advise all holders of securities requesting registration, and the number of shares of securities that are entitled to be included in the registration and underwriting (other than on behalf of the Company) as set forth in Section 1.13 hereof. Notwithstanding anything to the contrary, if the registration is the IPO and the underwriters exclude all Registrable Securities and other stockholders from such registration, the Company shall have no obligation to provide notice as set forth in this Section 1.3. If any person does not agree to the terms of any such underwriting, he or she shall be excluded therefrom by written notice from the Company or the underwriter. Any Registrable Securities or other securities excluded or withdrawn from such underwriting shall be withdrawn from such registration.

1.4. **Form S-3 Registration.** Following the Qualified IPO, the Company shall use its reasonable best efforts to qualify for registration on Form S-3 for secondary sales. After the Company has qualified for the use of Form S-3, if the Company shall receive from the Holders of at least twenty-five percent (25%) of the Registrable Securities (the “S-3 Initiating Holders”) a written request that the Company effect a registration on Form S-3 and any related qualification or compliance with respect to all or a part of the Registrable Securities owned by such Holder or Holders, the Company will:

(a) promptly give written notice of the proposed registration, and any related qualification or compliance, to all other Holders; and

(b) use its reasonable best efforts to effect, as soon as practicable, such registration and all such qualifications and compliances as may be so requested and as would permit or facilitate the sale and distribution of all or such portion of such Holders’ Registrable Securities as are specified in such request, together with all or such portion of the Registrable Securities of any other Holders joining in such request as are specified in a written request given within 15 days after receipt of such written notice from the Company; provided, however, that the Company shall not be obligated to effect any such registration, qualification or compliance, pursuant to this Section 1.4: (i) if Form S-3 is not available for such offering by the Holders under applicable law; (ii) if the Holders, together with the holders of any other securities of the Company entitled to inclusion in such registration, propose to sell Registrable Securities and such other securities (if any) pursuant to such registration at an aggregate price to the public of less than \$1,000,000; (iii) if the Company shall furnish to the Holders requesting a registration statement pursuant to this Section 1.4, a certificate signed by the President of the Company stating that in the good faith judgment of the Board, it would be seriously detrimental to the Company and its stockholders for such Form S-3 Registration to be effected at such time, in which event the Company shall have the right to defer the filing of the Form S-3 registration statement for a period of not more than 90 days after receipt of the request of the S-3 Initiating Holders; provided, however, that the Company shall not utilize this right more than once in any 12-month period; (iv) if the Company has, within the 24-month period preceding the date of such request, already effected one such registration on Form S-3 for the Holders pursuant to this Section 1.4; (v) in any jurisdiction in which the Company would be required to qualify to do business or to execute a general consent to service of process in effecting such registration, qualification or compliance unless the Company is already qualified to do business or subject to

service of process in that jurisdiction; or (vi) during the period ending 180 days after the effective date of a registration statement subject to Section 1.3.

(c) If the S-3 Initiating Holders intend to distribute the Registrable Securities covered by their request by means of an underwriting, they shall so advise the Company as part of their request made pursuant to this Section 1.4 and the Company shall include such information in the written notice referred to in Section 1.4(a). In such event, the right of any Holder to include its Registrable Securities in such registration shall be conditioned upon such Holder's participation in such underwriting and the inclusion of such Holder's Registrable Securities in the underwriting (unless otherwise mutually agreed by a majority in interest of the S-3 Initiating Holders and such Holder) to the extent provided herein. All Holders proposing to distribute their securities through such underwriting shall enter into an underwriting agreement in customary form with the underwriter or underwriters selected for such underwriting by the Company (which underwriter or underwriters shall be reasonably acceptable to a majority in interest of the S-3 Initiating Holders). Notwithstanding any other provision of this Section 1.4, if the underwriter advises the Company that marketing factors require a limitation of the number of securities underwritten (including Registrable Securities), then the Company shall so advise all Holders of Registrable Securities that would otherwise be underwritten pursuant hereto, and the number of shares that may be included in the underwriting shall be allocated to the Holders of such Registrable Securities on a pro rata basis based on the number of Registrable Securities held by all such Holders (including the S-3 Initiating Holders). In no event shall any Registrable Securities be excluded from such underwriting unless all other securities are first excluded. Any Registrable Security excluded or withdrawn from such underwriting shall be withdrawn from the registration.

(d) Subject to the foregoing, the Company shall file a registration statement covering the Registrable Securities and other securities so requested to be registered as soon as practicable after receipt of the request of the S-3 Initiating Holders. Registrations effected pursuant to this Section 1.4 shall not be counted as demands for registration or registrations effected pursuant to Sections 1.2 or 1.3, respectively.

1.5. **Obligations of the Company.** Whenever required under this Section 1 to effect the registration of any Registrable Securities, the Company shall, as expeditiously as reasonably possible:

(a) Prepare and file with the SEC a registration statement with respect to such Registrable Securities and use its reasonable best efforts to cause such registration statement to become effective, and, upon the request of the Holders of a majority of the Registrable Securities registered thereunder, keep such registration statement effective for up to 120 days, or until the distribution described in such registration statement is completed, if earlier; provided, however, that (1) such 120-day period shall be extended for a period of time equal to the period during which the Holders or partners or members, as applicable, refrain from selling any securities included in such registration in accordance with the provisions of Section 1.13 hereof; and (2) in the case of any registration of Registrable Securities on Form S-3 which are intended to be offered on a continuous or delayed basis, such 120-day period shall be extended until all such Registrable Securities are sold, provided that Rule 415, or any successor rule under the Securities Act, permits an offering on a continuous or delayed basis.

(b) Prepare and file with the SEC such amendments and supplements to such registration statement and the prospectus used in connection with such registration statement as may be necessary to comply with the provisions of the Securities Act with respect to the disposition of all securities covered by such registration statement for up to 120 days, or until the distribution described in such registration statement is completed, if earlier.

(c) Furnish to the Holders such numbers of copies of a prospectus, including a preliminary prospectus, in conformity with the requirements of the Securities Act, and such other documents as they may reasonably request in order to facilitate the disposition of Registrable Securities owned by them.

(d) Use its reasonable best efforts to register and qualify the securities covered by such registration statement under such other securities or Blue Sky laws of such jurisdictions as shall be reasonably requested by the Holders, provided that the Company shall not be required in connection therewith or as a condition thereto to qualify to do business or to file a general consent to service of process in any such states or jurisdictions unless the Company is already qualified to do business or subject to service of process in that jurisdiction.

(e) In the event of any underwritten public offering, enter into and perform its obligations under an underwriting agreement, in usual and customary form, with the managing underwriter of such offering. Each Holder participating in such underwriting shall also enter into and perform its obligations under such an agreement.

(f) Furnish, on the date that such Registrable Securities are delivered to the underwriters for sale, if such securities are being sold through underwriters or, if such securities are not being sold through underwriters, on the date that the registration statement with respect to such securities becomes effective, (1) an opinion, dated as of such date, of the counsel representing the Company for the purposes of such registration, in form and substance as is customarily given to underwriters in an underwritten public offering and reasonably satisfactory to a majority in interest of the Holders participating in such registration, addressed to the underwriters, if any, and to the Holders participating in such registration and (2) a letter, dated as of such date, from the independent certified public accountants of the Company, in form and substance as is customarily given by independent certified public accountants to underwriters in an underwritten public offering and reasonably satisfactory to a majority in interest of the Holders participating in such registration, addressed to the underwriters, if any, and if permitted by applicable accounting standards, to the Holders participating in such registration.

(g) Notify each Holder of Registrable Securities covered by such registration statement at any time when a prospectus relating thereto is required to be delivered under the Securities Act of the happening of any event as a result of which the prospectus included in such registration statement, as then in effect, includes an untrue statement of a material fact or omits to state a material fact required to be stated therein or necessary to make the statements therein not misleading in the light of the circumstances then existing.

(h) Keep the Holders, as applicable, advised in writing as to the initiation of each such registration and as to the completion thereof.

(i) Cause all such Registrable Securities registered pursuant to this Section 1 to be listed on each national securities exchange or trading system on which similar securities issued by the Company are then listed.

(j) Provide a transfer agent and registrar for all Registrable Securities registered pursuant hereunder and a CUSIP number for all such Registrable Securities, in each case not later than the effective date of such registration.

1.6. **Information from Holders.** It shall be a condition precedent to the obligations of the Company to take any action pursuant to this Section 1 with respect to the Registrable Securities of any selling Holder that such Holder shall furnish to the Company such information regarding itself, the Registrable Securities held by it, and the intended method of disposition of such securities as shall be required to effect the registration of such Holder's Registrable Securities. The Company shall have no obligation with respect to any registration requested pursuant to Section 1.2 or Section 1.4 of this Agreement if, as a result of the application of the preceding sentence, the anticipated aggregate offering price of the Registrable Securities to be included in the registration does not equal or exceed the anticipated aggregate offering price required to originally trigger the Company's obligation to initiate such registration as specified in subsection 1.2(a) or subsection 1.4(b)(2), whichever is applicable.

1.7. **Expenses of Registration.** All expenses, other than underwriting discounts and commissions, incurred in connection with registrations, filings or qualifications pursuant to Sections 1.2, 1.3 and 1.4 including (without limitation) all registration, filing and qualification fees, printers' and accounting fees, and the fees and disbursements of counsel for the Company and the reasonable fees and disbursements of one counsel for the selling Holders (which may be counsel for the Company) up to a maximum of \$50,000, shall be borne by the Company. Each Holder participating in a registration pursuant to this Section 1 shall bear such Holder's proportionate share (based on the number of shares sold by such Holder over the total number of shares included in such registration at the time it is declared effective) of all discounts, commissions or other amounts payable to underwriters or brokers in connection with such offering and the fees and disbursements of any counsel for the participating Holders in excess of \$50,000. The Company shall not be required to pay for any expenses of any registration proceeding begun pursuant to Section 1.2 if the registration request is subsequently withdrawn at the request of the Holders of a majority of the Registrable Securities to be registered (in which case all participating Holders shall bear such expenses), unless the Holders of a majority of the Registrable Securities agree to forfeit their right to one demand registration pursuant to Section 1.2; provided further, however, that, if at the time of such withdrawal, the Holders (i) have learned of a material adverse change in the condition, business, or prospects of the Company that was not known to the Holders at the time of their request and (ii) have withdrawn the request with reasonable promptness following disclosure by the Company of such material adverse change, then the Holders shall not be required to pay any of such expenses and shall not forfeit their rights pursuant to Section 1.2.

1.8. **Underwriting Requirements.** In connection with any offering involving an underwriting of shares of the Company's capital stock, the Company shall not be required under Section 1.3 to include any of the Holders' securities in such underwriting unless they accept the terms of the underwriting as agreed upon between the Company and the underwriters

selected by the Company (or by other persons entitled to select the underwriters) (provided, however, that such agreement shall not provide for indemnification or contribution obligations on the part of the Holders materially greater than the obligations of the Holders under Section 1.10(b) hereof) and then only in such quantity as the underwriters determine in their sole discretion will not jeopardize the success of the offering by the Company. If the total amount of securities, including Registrable Securities, requested by stockholders to be included in such offering exceeds the amount of securities sold other than by the Company that the underwriters determine in their sole discretion is compatible with the success of the offering, then the Company shall be required to include in the offering only that number of such securities, including Registrable Securities, which the underwriters determine in their sole discretion will not jeopardize the success of the offering (the securities so included to be apportioned pro rata among the selling stockholders according to the total amount of securities entitled to be included therein owned by each selling stockholder or in such other proportions as shall mutually be agreed to by such selling stockholders) but in no event shall the amount of securities of the selling Holders included in the offering be reduced below 30% of the total amount of securities included in such offering, unless such offering is the IPO, in which case, the selling stockholders may be excluded partially or entirely if the underwriters make the determination described above and no other stockholder's securities are included. For purposes of the preceding parenthetical concerning apportionment, for any selling stockholder which is a holder of Registrable Securities and which is a venture capital fund, or a partnership or corporation, the Affiliated Funds, partners, retired partners and stockholders of such Holder, or the estates and family members of any such partners and retired partners and any trusts for the benefit of any of the foregoing persons shall be deemed to be a single "selling stockholder" and any pro-rata reduction with respect to such "selling stockholder" shall be based upon the aggregate amount of shares carrying registration rights owned by all entities and individuals included in such "selling stockholder," as defined in this sentence.

1.9. **Delay of Registration.** No Holder shall have any right to obtain or seek an injunction restraining or otherwise delaying any such registration as the result of any controversy that might arise with respect to the interpretation or implementation of this Section 1.

1.10. **Indemnification.** In the event any Registrable Securities are included in a registration statement under this Section 1:

(a) To the extent permitted by law, the Company will indemnify and hold harmless each Holder, such Holder's officers, directors, partners and members (each, a "Holder Party"), any underwriter (as defined in the Securities Act) for such Holder and each person, if any, who controls such Holder or underwriter within the meaning of the Securities Act or the Exchange Act, against any losses, claims, damages, or liabilities (joint or several) to which they may become subject under the Securities Act, the Exchange Act or other federal or state law, insofar as such losses, claims, damages, or liabilities (or actions in respect thereof) arise out of or are based upon any of the following statements, omissions or violations (collectively a "Violation"): (i) any untrue statement or alleged untrue statement of a material fact contained in such registration statement, including any preliminary prospectus or final prospectus contained therein or any amendments or supplements thereto, (ii) the omission or alleged omission to state therein a material fact required to be stated therein, or necessary to make the statements therein

not misleading, or (iii) any violation or alleged violation by the Company of the Securities Act, the Exchange Act, any state securities law or any rule or regulation promulgated under the Securities Act, the Exchange Act or any state securities law; and the Company will pay to each such Holder, Holder Party, underwriter or controlling person, as incurred, any legal or other expenses reasonably incurred by them in connection with investigating or defending any such loss, claim, damage, liability, or action; provided, however, that the indemnity agreement contained in this subsection 1.10(a) shall not apply to amounts paid in settlement of any such loss, claim, damage, liability, or action if such settlement is effected without the consent of the Company (which consent shall not be unreasonably withheld), nor shall the Company be liable to any Holder, Holder Party, underwriter or controlling person for any such loss, claim, damage, liability, or action to the extent that it arises out of or is based upon a Violation which arises out of or is based upon and in conformity with written information furnished expressly for use in connection with such registration by any such Holder, Holder Party, underwriter or controlling person.

(b) To the extent permitted by law, each selling Holder will indemnify and hold harmless the Company, each of its directors, each of its officers who has signed the registration statement, each person, if any, who controls the Company within the meaning of the Securities Act, any underwriter of the Company's securities covered by such a registration statement, any other Holder selling securities in such registration statement and any controlling person of any such underwriter or other Holder, against any losses, claims, damages, or liabilities (joint or several) to which any of the foregoing persons may become subject, under the Securities Act, the Exchange Act or other federal or state law, insofar as such losses, claims, damages, or liabilities (or actions in respect thereto) arise out of or are based upon any Violation, in each case to the extent (and only to the extent) that such Violation occurs in reliance upon and in conformity with written information furnished by such Holder expressly for use in connection with such registration; and each such Holder will pay, as incurred, any legal or other expenses reasonably incurred by any person intended to be indemnified pursuant to this subsection 1.10(b), in connection with investigating or defending any such loss, claim, damage, liability, or action; provided, however, that the indemnity agreement contained in this subsection 1.10(b) shall not apply to amounts paid in settlement of any such loss, claim, damage, liability or action if such settlement is effected without the consent of the Holder, which consent shall not be unreasonably withheld provided that in no event shall any indemnity under this subsection 1.10(b) exceed the net proceeds from the offering received by such Holder, except in the case of willful fraud by such Holder.

(c) Promptly after receipt by an indemnified party under this Section 1.10 of notice of the commencement of any action (including any governmental action), such indemnified party will, if a claim in respect thereof is to be made against any indemnifying party under this Section 1.10, deliver to the indemnifying party a written notice of the commencement thereof and the indemnifying party shall have the right to participate in, and, to the extent the indemnifying party so desires, jointly with any other indemnifying party similarly noticed, to assume the defense thereof with counsel mutually satisfactory to the parties; provided, however, that an indemnified party (together with all other indemnified parties which may be represented without conflict by one counsel) shall have the right to retain one separate counsel, with the reasonable fees and expenses to be paid by the indemnifying party, if representation of such indemnified party by the counsel retained by the indemnifying party would be inappropriate due

to actual or potential differing interests between such indemnified party and any other party represented by such counsel in such proceeding. The failure to deliver written notice to the indemnifying party within a reasonable time of the commencement of any such action, if prejudicial to its ability to defend such action, shall relieve such indemnifying party of any liability to the indemnified party under this Section 1.10, but the omission so to deliver written notice to the indemnifying party will not relieve it of any liability that it may have to any indemnified party otherwise than under this Section 1.10.

(d) If the indemnification provided for in this Section 1.10 is held by a court of competent jurisdiction to be unavailable to an indemnified party with respect to any loss, liability, claim, damage or expense referred to therein, then the indemnifying party, in lieu of indemnifying such indemnified party hereunder, shall contribute to the amount paid or payable by such indemnified party as a result of such loss, liability, claim, damage, or expense in such proportion as is appropriate to reflect the relative fault of the indemnifying party on the one hand and of the indemnified party on the other in connection with the statements or omissions that resulted in such loss, liability, claim, damage or expense as well as any other relevant equitable considerations; provided that in no event shall any contribution by a Holder under this subsection 1.10(d) exceed the net proceeds from the offering received by such Holder, except in the case of willful fraud by such Holder. The relative fault of the indemnifying party and of the indemnified party shall be determined by reference to, among other things, whether the untrue or alleged untrue statement of a material fact or the omission or alleged omission to state a material fact relates to information supplied by the indemnifying party or by the indemnified party and the parties' relative intent, knowledge, access to information, and opportunity to correct or prevent such statement or omission.

(e) Notwithstanding the foregoing, to the extent that the provisions on indemnification and contribution contained in the underwriting agreement entered into in connection with the underwritten public offering are in conflict with the foregoing provisions, the provisions in the underwriting agreement shall control.

(f) The obligations of the Company and Holders under this Section 1.10 shall survive the completion of any offering of Registrable Securities in a registration statement under this Section 1, and otherwise.

1.11. **Reports under the Exchange Act.** With a view to making available to the Holders the benefits of Rule 144 promulgated under the Securities Act and any other rule or regulation of the SEC that may at any time permit a Holder to sell securities of the Company to the public without registration or pursuant to a registration on Form S-3, the Company agrees to use its reasonable best efforts to:

(a) make and keep public information available, as those terms are understood and defined in SEC Rule 144, at all times after 90 days after the effective date of the Qualified IPO so long as the Company remains subject to the periodic reporting requirements under Sections 13 or 15(d) of the Exchange Act;

(b) take such action, including the voluntary registration of its Common Stock under Section 12 of the Exchange Act, as is necessary to enable the Holders to

utilize Form S-3 for the sale of their Registrable Securities, such action to be taken as soon as practicable after the end of the fiscal year in which the first registration statement filed by the Company for the offering of its securities to the general public is declared effective;

(c) file with the SEC in a timely manner all reports and other documents required of the Company under the Securities Act and the Exchange Act at any time after it has become subject to such reporting requirements; and

(d) furnish to any Holder upon request, so long as the Holder owns any Registrable Securities, (i) a written statement by the Company that it has complied with the reporting requirements of SEC Rule 144 (at any time after 90 days after the effective date of the Qualified IPO), the Securities Act and the Exchange Act (at any time after it has become subject to such reporting requirements), or that it qualifies as a registrant whose securities may be resold pursuant to Form S-3 (at any time after it so qualifies), (ii) a copy of the most recent annual or quarterly report of the Company and such other reports and documents so filed by the Company, and (iii) such other information as may be reasonably requested in availing any Holder of any rule or regulation of the SEC which permits the selling of any such securities without registration or pursuant to such form.

1.12. **Assignment of Registration Rights.** The rights to cause the Company to register Registrable Securities pursuant to this Section 1 may be assigned (but only with all related obligations) by a Holder to a transferee or assignee (i) of at least 75,000 shares of such securities (subject to adjustment for stock splits, stock dividends, reclassification or the like) (or if the transferring Holder owns less than 75,000 shares of such securities, then all Registrable Securities held by the transferring Holder), (ii) that is a subsidiary, parent, partner, limited partner, retired partner, member, retired member or stockholder of a Holder, (iii) that is an Affiliated Fund, (iv) who is a Holder's child, stepchild, grandchild, parent, stepparent, grandparent, spouse, sibling, mother-in-law, father-in-law, son-in-law, daughter-in-law, brother-in-law, or sister-in-law (such a relation, a Holder's "Immediate Family Member," which term shall include adoptive relationships), or (v) that is a trust for the benefit of an individual Holder or such Holder's Immediate Family Member, provided the Company is, within a reasonable time after such transfer, furnished with written notice of the name and address of such transferee or assignee and the securities with respect to which such registration rights are being assigned; and provided, further that such assignment shall be effective only if the transferee agrees to be bound by this Agreement and immediately following such transfer the further disposition of such securities by the transferee or assignee is restricted under the Securities Act. For the purposes of determining the number of shares of Registrable Securities held by a transferee or assignee, the holdings of transferees and assignees of (x) a partnership who are partners or retired partners of such partnership or (y) a limited liability company who are members or retired members of such limited liability company (including Immediate Family Members of such partners or members who acquire Registrable Securities by gift, will or intestate succession) shall be aggregated together and with the partnership or limited liability company; provided that all assignees and transferees who would not qualify individually for assignment of registration rights shall have a single attorney-in-fact for the purpose of exercising any rights, receiving notices or taking any action under Section 1.

1.13. **Lock-Up Agreement**

(a) **Lock-Up Period; Agreement.** Each Holder hereby agrees that it shall not, to the extent requested by the Company or an underwriter of securities of the Company, sell or otherwise transfer or dispose of any Registrable Securities or other shares of stock of the Company then owned by such Holder (other than to donees or partners of the Holder who agree to be similarly bound) for up to one hundred eighty (180) days following the effective date of any registration statement of the Company filed under the Securities Act; provided however that, if during the last 17 days of the restricted period the Company issues an earnings release or material news or a material event relating to the Company occurs, or prior to the expiration of the restricted period the Company announces that it will release earnings results during the 16-day period beginning on the last day of the restricted period, and if the Company's securities are listed on the Nasdaq Stock Market and Rule 2711 thereof applies, then the restrictions imposed by this Section 1.13 shall continue to apply until the expiration of the 18-day period beginning on the issuance of the earnings release or the occurrence of the material news or material event. In no event will the restricted period extend beyond two hundred and fifteen (215) days after the effective date of the registration statement.

(b) **Limitations.** The obligations described in subsection 1.13(a):

(i) apply only to the Company's initial public offering;

(ii) will not apply unless all executive officers and directors of the Company then holding Common Stock of the Company and all stockholders holding in the aggregate at least 1% of the total equity of the Company, enter into substantially identical agreements; and

(iii) will not apply to any shares purchased pursuant to such registration statement by a Holder.

(c) **No Selective Relief.** Any relief granted by the Company or such underwriters from the obligations described in subsection 1.13(a) must be granted ratably to all Holders subject to such obligations.

(d) **Stop-Transfer Instructions.** In order to enforce the foregoing covenants, the Company may impose stop-transfer instructions with respect to the securities of each Holder (and the securities of every other person subject to the restrictions in subsection 1.13(a)).

(e) **Transferees Bound.** Each Holder agrees that it will not transfer securities of the Company unless each transferee agrees in writing to be bound by all of the provisions of this Section 1.13. Furthermore, for purposes of this Section 1.13, the term "Company" shall include any wholly-owned subsidiary of the Company into which the Company merges or consolidates.

(f) **Further Assurances.** Each Holder further agrees to enter into any agreement reasonably required by the underwriters to implement this Section 1.13 within any reasonable timeframe so requested.

1.14. **Grant of Future Registration Rights.** Future registration rights that are superior to or on parity with the rights of the Investors hereunder require the consent of the Company and the holders of a majority of the Registrable Securities.

1.15. **Termination of Registration Rights.** No Holder shall be entitled to exercise any right provided for in this Section 1 after the earlier of (i) five years following the consummation of a Qualified IPO, or (ii) with respect to any Holder, at such time after the Qualified IPO as Rule 144 or another similar exemption under the Securities Act is available for the sale of all of such Holder's shares during a three-month period without registration.

2. **Covenants of the Company.**

2.1. **Delivery of Financial Information.** The Company shall deliver to each Major Investor (other than a Major Investor reasonably deemed by the Company to be a competitor of the Company):

(a) as soon as practicable, but in any event within 120 days after the end of each fiscal year of the Company (or such longer period as may be approved by the Board), an audited income statement for such fiscal year, an audited balance sheet of the Company and statement of stockholder's equity as of the end of such year, and an audited statement of cash flows for such year, such year-end financial reports to be in reasonable detail, prepared in accordance with generally accepted accounting principles ("GAAP") on an accrual basis where applicable;

(b) as soon as practicable, but in any event within 45 days after the end of each of the first three quarters of each fiscal year of the Company, an unaudited profit or loss statement, an unaudited statement of cash flows for such fiscal quarter and an unaudited balance sheet as of the end of such fiscal quarter;

(c) as soon as practicable, but in any event at least 30 days prior to the end of each fiscal year, a budget and business plan for the next fiscal year;

(d) within forty-five (45) days of receipt by the Company, copies of all audit reports;

(e) copies of all other reports sent to stockholders;

(f) upon request, a copy of the then-current capitalization table of the Company; and

(g) such other information as such Major Investor may reasonably request.

2.2. **Inspection.** The Company shall permit each Significant Holder (except for a Significant Holder reasonably deemed by the Company to be a competitor of the Company), at such Significant Holder's expense, to visit and inspect the Company's properties, to examine its books of account and records and to discuss the Company's affairs, finances and accounts with its officers, all at such reasonable times as requested by the Significant Holder and

reasonably agreed by the Company during normal business hours upon one business day's advance written notice; provided, however, that the Company shall not be obligated pursuant to this Section 2.2 to provide access to any information which it reasonably considers to be a trade secret or similar confidential information.

2.3. **Right of First Offer.** Subject to the terms and conditions specified in this Section 2.3, the Company hereby grants to each Significant Holder (other than a Significant Holder reasonably deemed by the Company to be a competitor of the Company) a right of first offer with respect to any sales by the Company of its Shares (as hereinafter defined) after the date hereof. For purposes of this Section 2.3, Significant Holder includes any general partners, managing members and affiliates of a Major Investor, including Affiliated Funds. A Significant Holder who chooses to exercise the right of first offer shall be entitled to apportion the right of first offer hereby granted it among itself and its partners and affiliates, including Affiliated Funds, in such proportions as it deems appropriate. Each time the Company proposes to offer any shares of, or securities convertible into or exercisable for any shares of, any class of its capital stock ("Shares"), the Company shall first make an offering of such Shares to each Significant Holder in accordance with the following provisions:

(a) The Company shall deliver a notice (the "RFO Notice") to the Significant Holders stating (i) its bona fide intention to offer such Shares, (ii) the number of such Shares to be offered, and (iii) the price and terms upon which it proposes to offer such Shares.

(b) Within 15 business days after delivery of the RFO Notice, the Significant Holder may elect to purchase or obtain, at the price and on the terms specified in the RFO Notice, up to that portion of such Shares which equals the proportion that the number of shares of Common Stock issued and held, or issuable upon conversion and exercise of all convertible or exercisable securities then held, by such Significant Holder bears to the sum of (A) the total number of shares of Common Stock then outstanding (assuming full conversion and exercise of all convertible or exercisable securities) and (B) shares of Common Stock issuable to employees, consultants or directors pursuant to a stock option plan, restricted stock plan, or other stock plan approved by the Board. Such purchase shall be completed at the same closing as that of any third party purchasers or at an additional closing thereunder. The Company shall promptly, in writing, inform each Significant Holder that purchases all the shares available to it (each, a "Fully-Exercising Investor") of any other Significant Holder's failure to do likewise. During the 10-day period commencing after receipt of such information, each Fully-Exercising Investor shall be entitled to obtain that portion of the Shares for which Significant Holders were entitled to subscribe but which were not subscribed for by the Significant Holders that is equal to the proportion that the number of shares of Common Stock issued and held, or issuable upon conversion and exercise of all convertible or exercisable securities then held, by such Fully-Exercising Investor bears to the total number of shares of Common Stock then issued and held, or issuable upon conversion and exercise of all convertible or exercisable securities then held, by all Fully-Exercising Investors.

(c) The Company may, during the 45-day period following the expiration of the 10-day period provided in subsection 2.3(b) hereof; offer the remaining unsubscribed portion of the Shares to any person or persons at a price not less than, and upon terms no more favorable to the offeree than those specified in the RFO Notice. If the Company

does not enter into an agreement for the sale of the Shares within such period, or if such agreement is not consummated within 60 days of the execution thereof, the right provided hereunder shall be deemed to be revived and such Shares shall not be offered unless first reoffered to the Significant Holders in accordance herewith.

(d) The right of first offer in this Section 2.3 shall not be applicable to:

(i) shares of Common Stock issued or issuable upon conversion of the outstanding shares of the Preferred Stock;

(ii) shares of capital stock issued pursuant to the Series E Agreement;

(iii) shares of Common Stock or Preferred Stock (or options, warrants or rights therefor) granted or issued hereafter to employees, officers, directors, contractors, consultants or advisers to, the Company or any Subsidiary pursuant to incentive agreements, stock purchase or stock option plans, stock bonuses or awards, warrants, contracts or other arrangements that are approved by the Board;

(iv) shares of Common Stock or Preferred Stock (or options, warrants or rights therefor) issued to parties that are: (a) strategic partners investing in connection with a commercial relationship with the Company, or (b) providing the Company with equipment leases, real property leases, loans, credit lines, guaranties of indebtedness, cash price reductions or similar transactions, under arrangements, in each case, where such issuances are not intended as a source of equity financing for the Company and approved by the Board;

(v) shares of capital stock issued pursuant to the acquisition of another Company or entity by the Company by consolidation, merger, purchase of all or substantially all of the assets, or other reorganization in which the Company acquires, in a single transaction or series of related transactions, all or substantially all of the assets of such other Company or entity or fifty percent (50%) or more of the voting power of such other Company or entity or fifty percent (50%) or more of the equity ownership of such other entity, provided that such transaction or series of transactions has been approved by the Board; or pursuant to the purchase of less than a fifty percent (50%) equity ownership in connection with a joint venture or other strategic arrangement or other commercial relationship, provided such an arrangement is approved by the Board;

(vi) shares of Common Stock or Preferred Stock issuable upon exercise of any options, warrants or rights to purchase any securities of the Company outstanding as of the date of the filing of the Amended and Restated Certificate of the Company and any securities issuable upon the conversion thereof;

(vii) shares of Common Stock issued pursuant to (A) a dividend or other distribution on outstanding Common Stock, (B) a subdivision of the outstanding shares of Common Stock into a greater number of shares of Common Stock, or (C) a combination of the outstanding shares of Common Stock into a smaller number of shares of Common Stock;

(viii) shares of Common Stock issued or issuable in a public offering prior to or in connection with which all outstanding shares of Preferred Stock will be converted to Common Stock; and

(ix) shares of Common Stock or Preferred Stock (or options, or warrants or rights to acquire same), issued or issuable hereafter that are (A) approved by the Board, and (B) approved by the vote of the holders of at least 60% of the then outstanding shares of Preferred Stock held by the Investors, voting together as a single class, as being excluded from the right of first refusal under this Section 2.3.

(e) In addition to the foregoing, the right of first offer in this Section 2.3 shall not be applicable with respect to any Significant Holder and any subsequent securities issuance, if (i) at the time of such subsequent securities issuance, the Significant Holder is not an “accredited investor,” as that term is then defined in Rule 501(a) under the Securities Act, and (ii) such subsequent securities issuance is otherwise being offered only to accredited investors.

2.4. Termination of Covenants.

(a) The covenants set forth in Sections 2.1 through Section 2.3 shall terminate as to each Holder and be of no further force or effect immediately prior to the consummation of a Qualified IPO.

(b) The covenants set forth in Sections 2.1 and 2.2 shall terminate as to each Holder and be of no further force or effect when the Company first becomes subject to (or upon a Change of Control (as defined in the Restated Certificate) where the successor company is subject to) the periodic reporting requirements of Sections 13 or 15(d) of the Exchange Act, if this occurs earlier than the event described in subsection 2.4(a) above.

3. Other Covenants.

3.1. **Employee Vesting.** Except as otherwise approved by the Board, including the affirmative vote of at least one director designated by the holders of Preferred Stock, options granted to employees of the Company (or shares of restricted stock issued to such employees) shall be subject to vesting over a four-year period, with the first 25% vesting twelve (12) months following the date of hire, and the remainder vesting ratably each month thereafter.

3.2. **Employee Loans.** The Company shall not make any loans to its employees unless such loan is approved by the Board, including the affirmative vote of at least one director designated by the holders of Preferred Stock.

3.3. **Interested Transactions.** The Company shall not enter into or amend in any material respect any agreement, arrangement or transaction between the Company and any of the Company’s executive officers, directors or affiliates unless approved by the disinterested members of the Board, including the affirmative vote of at least one of the disinterested directors designated by the holders of Preferred Stock.

3.4. **Conduct of Business.** Except as agreed in writing by the holders of at least 60% of the outstanding shares of Preferred Stock held by the Investors, voting together as a single class, the Company will:

(a) continue to engage in business of the same general type as now conducted or as presently contemplated by it and preserve, renew and keep in full force and effect its corporate existence and take all reasonable action to maintain all rights, privileges and franchises necessary or desirable in the normal conduct of its business;

(b) require all of its employees or consultants to enter into appropriate confidentiality agreements to protect confidential information relating to the Company and its business, including trade secrets;

(c) comply in all material respects with all applicable laws, rules, regulations and orders except where the failure to comply would not have a material adverse effect on the business, properties, results of operations or condition of the Company;

(d) maintain insurance with responsible and reputable insurance companies or associations in such amounts and covering such risks as is usually carried by companies of similar size and credit standing engaged in similar business and owning similar properties, provided that such insurance is and remains available to the Company at commercially reasonable rates, as determined by the Board; and

(e) keep proper books of record and account, in which full and correct entries shall be made of all financial transactions and the assets and business of the Company to facilitate the preparation of financial statements by the Company in accordance with GAAP.

3.5. **Termination of Covenants.** The covenants set forth in this Section 3 shall terminate as to each Holder and be of no further force or effect immediately prior to the consummation of a Qualified IPO.

4. **Miscellaneous.**

4.1. **Amendment and Restatement of Prior Rights Agreement; Entire Agreement.** Pursuant to Section 4.3 of the Prior Rights Agreement, the undersigned parties who are parties to such Prior Rights Agreement hereby amend and restate the Prior Rights Agreement to read in its entirety as set forth in this Agreement, all with the intent and effect that the Prior Rights Agreement shall hereby be terminated and entirely replaced and superseded by this Agreement. This Agreement constitutes the entire agreement between the parties hereto pertaining to the subject matter hereof; and any and all other written or oral agreements relating to the subject matter hereof existing between the parties hereto, including the Prior Rights Agreement, are expressly canceled and superseded.

4.2. **Successors and Assigns.** Except as otherwise provided in this Agreement, the terms and conditions of this Agreement shall inure to the benefit of and be binding upon the respective permitted successors and assigns of the parties (including transferees of any of the Preferred Stock or any Common Stock issued upon conversion thereof). Nothing in

this Agreement, express or implied, is intended to confer upon any party other than the parties hereto or their respective successors and assigns any rights, remedies, obligations, or liabilities under or by reason of this Agreement, except as expressly provided in this Agreement.

4.3. **Amendments and Waivers.** Any term of this Agreement may be amended or waived only with the written consent of the Company and the holders of at least 60% of the outstanding shares of Preferred Stock held by the Investors, voting together as a single class. Notwithstanding the foregoing, this Agreement may be amended with only the written consent of the Company for the sole purpose of including additional purchasers of Preferred Stock as “Investors” and “Holders” pursuant to the Series E Agreement. Any amendment or waiver effected in accordance with this paragraph shall be binding upon each party to the Agreement, whether or not such party has signed such amendment or waiver, each future holder of all such Registrable Securities, and the Company.

4.4. **Notices.** Any notice required or permitted to be given to a party pursuant to the provisions of this Agreement will be in writing and will be effective and deemed given to such party under this Agreement on the earliest of the following:

- (a) the date of personal delivery;
- (b) one (1) business day after transmission by facsimile or electronic mail, addressed to the other party at its facsimile number or electronic mail address specified herein (or hereafter noticed to the parties hereto), with confirmation of transmission;
- (c) one (1) business day after deposit with a return receipt express courier for United States deliveries, or three (3) business days after such deposit for deliveries outside of the United States; or
- (d) three (3) business days after deposit in the United States mail by registered or certified mail (return receipt requested) for United States deliveries.

All notices not delivered personally or by facsimile or electronic mail will be sent with postage and/or other charges prepaid and properly addressed to the party to be notified at the address set forth below such party’s signature on this Agreement or on an Exhibit hereto, or at such other address as such other party may designate by ten (10) days advance written notice to the other parties hereto. All notices for delivery outside the United States will be sent by facsimile or electronic mail or by express courier. Any notice given hereunder to more than one person will be deemed to have been given, for purposes of counting time periods hereunder, on the date effectively given to the last party required to be given such notice. Notices to the Company will be marked “Attention: President.”

4.5. **Severability.** If one or more provisions of this Agreement are held to be unenforceable under applicable law, such provision shall be excluded from this Agreement, and the balance of the Agreement shall be interpreted as if such provision were so excluded and shall be enforceable in accordance with its terms.

4.6. **Governing Law.** This Agreement and all acts and transactions pursuant hereto shall be governed, construed and interpreted in accordance with the laws of the State of Delaware, without giving effect to principles of conflicts of laws.

4.7. **Counterparts.** This Agreement may be executed in two or more counterparts, each of which shall be deemed an original, but all of which together shall constitute one and the same instrument.

4.8. **Titles and Subtitles.** The titles and subtitles used in this Agreement are used for convenience only and are not to be considered in construing or interpreting this Agreement.

4.9. **Aggregation of Stock.** All shares of the Series A Preferred Stock, the Series B Preferred Stock, the Series C Preferred Stock, the Series D Preferred Stock or the Series E Preferred Stock, as applicable, held or acquired by affiliated entities or persons shall be aggregated together for the purpose of determining the availability of any rights under this Agreement.

[Signature page follows]

The parties have executed this Amended and Restated Investors' Rights Agreement as of the date first above written.

THE COMPANY:

ENPHASE ENERGY, INC.

Name: /s/ Paul Nahi

By: Paul Nahi

Title: President and CEO

Address: 201 1st Street Suite 300
Petaluma, CA 94952

**SIGNATURE PAGE TO THE AMENDED AND RESTATED
INVESTORS' RIGHTS AGREEMENT OF ENPHASE ENERGY, INC.**

The parties have executed this Amended and Restated Investors' Rights Agreement as of the date first above written.

THE INVESTORS:

By: /s/ Paul Nahi
Paul Nahi

By: /s/ Raghuvveer Belur
Raghuvveer Belur

By: /s/ Martin Fornage
Martin Fornage

By: /s/ Andrew Nichols
Andrew Nichols

By: /s/ John Nichols
John Nichols

By: /s/ William Orenstein
William Orenstein

By: /s/ Paul Elliot
Paul Elliot

**SIGNATURE PAGE TO THE AMENDED AND RESTATED
INVESTORS' RIGHTS AGREEMENT OF ENPHASE ENERGY, INC.**

The parties have executed this Amended and Restated Investors' Rights Agreement as of the date first above written.

THE INVESTORS:

MADRONE PARTNERS, L.P.

By: Madrone Capital Partners, LLC, its general partner

By: /s/ James McInnis

Name: James McInnis

Title: Managing Member

Address: 3000 Sand Hill Road
Building 1, Suite 150
Menlo Park, CA 94025

**SIGNATURE PAGE TO THE AMENDED AND RESTATED
INVESTORS' RIGHTS AGREEMENT OF ENPHASE ENERGY, INC.**

The parties have executed this Amended and Restated Investors' Rights Agreement as of the date first above written.

THE INVESTORS:

ROCKPORT CAPITAL PARTNERS II, L.P.

By: RockPort Capital II, L.L.C., its General Partner

By: /s/ Stoddard Wilson

Name: Stoddard Wilson

Title: Managing Member

Address: c/o RockPort Capital
160 Federal Street
18th Floor
Boston, MA 02110-1700

**SIGNATURE PAGE TO THE AMENDED AND RESTATED
INVESTORS' RIGHTS AGREEMENT OF ENPHASE ENERGY, INC.**

The parties have executed this Amended and Restated Investors' Rights Agreement as of the date first above written.

THE INVESTORS:

THIRD POINT PARTNERS QUALIFIED L.P.
THIRD POINT PARTNERS L.P.
THIRD POINT OFFSHORE MASTER FUND L.P.
THIRD POINT ULTRA MASTER FUND L.P.

By: Third Point LLC

By: /s/ James P. Gallagher

Name: James P. Gallagher

Title: CAO

Address: c/o Third Point LLC
390 Park Ave., 18th Floor
New York, NY 10022
Attn: James P. Gallagher

**SIGNATURE PAGE TO THE AMENDED AND RESTATED
INVESTORS' RIGHTS AGREEMENT OF ENPHASE ENERGY, INC.**

The parties have executed this Amended and Restated Investors' Rights Agreement as of the date first above written.

THE INVESTORS:

APPLIED VENTURES LLC

By: /s/ J. Christopher Moran
Name: J. Christopher Moran
Title: Vice President, General Manager

Address: c/o Applied Materials, Inc.
3050 Bowers Avenue
Santa Clara, CA 95054-3299

**SIGNATURE PAGE TO THE AMENDED AND RESTATED
INVESTORS' RIGHTS AGREEMENT OF ENPHASE ENERGY, INC.**

The parties have executed this Amended and Restated Investors' Rights Agreement as of the date first above written.

INVESTORS:

COMPASS HORIZON FUNDING COMPANY LLC

By: Horizon Technology Finance Management LLC,
its adviser

By: /s/ Robert D. Pomeroy, Jr.

Name: Robert D. Pomeroy, Jr.

Title: Chief Executive Officer

**SIGNATURE PAGE TO THE AMENDED AND RESTATED
INVESTORS' RIGHTS AGREEMENT OF ENPHASE ENERGY, INC.**

The parties have executed this Amended and Restated Investors' Rights Agreement as of the date first above written.

THE INVESTORS:

**JOHN F. NICHOLS REVOCABLE TRUST,
UNDER AGREEMENT DATED JUNE 12, 1998**

By: /s/ John F. Nichols
Name: John F. Nichols
Title: Trustee

**SIGNATURE PAGE TO THE AMENDED AND RESTATED
INVESTORS' RIGHTS AGREEMENT OF ENPHASE ENERGY, INC.**

The parties have executed this Amended and Restated Investors' Rights Agreement as of the date first above written.

THE INVESTORS:

By: /s/ Daniel Loeb
Daniel Loeb

**SIGNATURE PAGE TO THE AMENDED AND RESTATED
INVESTORS' RIGHTS AGREEMENT OF ENPHASE ENERGY, INC.**

The parties have executed this Amended and Restated Investors' Rights Agreement as of the date first above written.

THE INVESTORS:

DONALD & MAUREEN GREEN LIVING TRUST

By: /s/ Donald Green
Name: Donald Green
Title: Trustee

Address: 950 Shiloh Vista
Santa Rosa, CA 95403

**SIGNATURE PAGE TO THE AMENDED AND RESTATED
INVESTORS' RIGHTS AGREEMENT OF ENPHASE ENERGY, INC.**

The parties have executed this Amended and Restated Investors' Rights Agreement as of 3/30, 2010.

THE INVESTORS:

G&W VENTURES

By: /s/ William C. White
Name: William C. White
Title: Manager

Address: 201 1st Street, Suite 100
Petaluma, CA 94952

**SIGNATURE PAGE TO THE AMENDED AND RESTATED
INVESTORS' RIGHTS AGREEMENT OF ENPHASE ENERGY, INC.**

The parties have executed this Amended and Restated Investors' Rights Agreement as of April 5, 2010.

THE INVESTORS:

**Flextronics International USA, Inc., a California
corporation**

By: /s/ Donald Standley

Name: Donald Standley

Title: Vice President, Director of Tax

**SIGNATURE PAGE TO THE AMENDED AND RESTATED
INVESTORS' RIGHTS AGREEMENT OF ENPHASE ENERGY, INC.**

The parties have executed this Amended and Restated Investors' Rights Agreement as of April 5, 2010.

INVESTORS:

PCG CLEAN ENERGY & TECHNOLOGY FUND LLC

By: /s/ Mark A. Nydau
Name: Mark A. Nydau
Title: Managing Director

By: /s/ Kara Boone King
Name: Kara Boone King
Title: Managing Director

**PCG CLEAN ENERGY & TECHNOLOGY FUND (EAST)
LLC**

By: /s/ Mark A. Nydau
Name: Mark A. Nydau
Title: Managing Director

By: /s/ Kara Boone King
Name: Kara Boone King
Title: Managing Director

Address: 1200 Prospect Street, Suite 200
La Jolla, CA 92037

**SIGNATURE PAGE TO THE AMENDED AND RESTATED
INVESTORS' RIGHTS AGREEMENT OF ENPHASE ENERGY, INC.**

The parties have executed this Amended and Restated Investors' Rights Agreement as of April 5, 2010.

INVESTORS:

By: /s/ Jim Carstensen
Jim Carstensen

By: /s/ Robert Schwartz
Robert Schwartz

By: /s/ Timothy Lash
Timothy Lash

By: /s/ David Fisher
David Fisher

By: /s/ William Orenstein
William Orenstein

By: /s/ Tom Birdsall and Rebecca Green
Tom Birdsall and Rebecca Green

By: /s/ Ellen Schwab
Ellen Schwab

**SIGNATURE PAGE TO THE AMENDED AND RESTATED
INVESTORS' RIGHTS AGREEMENT OF ENPHASE ENERGY, INC.**

The parties have executed this Amended and Restated Investors' Rights Agreement as of May 21, 2010.

INVESTORS:

CONTRA COSTA CAPITAL, LLC

By: /s/ Stephan Segouin
Name: Stephan Segouin
Title: Vice President

**SIGNATURE PAGE TO THE AMENDED AND RESTATED
INVESTORS' RIGHTS AGREEMENT OF ENPHASE ENERGY, INC.**

The parties have executed this Amended and Restated Investors' Rights Agreement as of May 21, 2010.

INVESTORS:

KPCB HOLDINGS, INC., AS NOMINEE

By: /s/ John Denniston
Name: John Denniston
Title: Senior Vice President

**SIGNATURE PAGE TO THE AMENDED AND RESTATED
INVESTORS' RIGHTS AGREEMENT OF ENPHASE ENERGY, INC.**

Schedule A

Investors

Bay Partners XI, L.P.
Bay Partners XI Parallel Fund, L.P.
Madrone Partners, L.P.
RockPort Capital Partners II, LP
Third Point Partners Qualified L.P.
Third Point Partners L.P.
Third Point Offshore Master Fund L.P.
Third Point Ultra Master Fund L.P.
TGI Holdings, LLC
James A. Stern Trust F/B/O Peter Stern
James A. Stern Trust F/B/O David Stern
Thomas G. Mendell
Emil Meshberg
Applied Ventures, LLC
ATEL Ventures, Inc. as Trustee
Raghuvveer Belur
Tom Birdsall and Rebecca Green
Martin Fornage
G&W Ventures
Donald and Maureen Green Living Trust
Michael Hatfield
J. Rick Johnston
Ted Lord
Steve Milborrow
William Orenstein
Ellen Schwab
Redstone Investments LLC
J. Steve Sheppard
F&W Investments LLC – Series 2006
Daniel Loeb
Timothy Lash
Robert Schwartz
Brian Hamel
Ray Moser
David Fisher
Restatement of James H. Carstensen 1995 Revocable Trust dated, March 13, 2000
Ed Falsetti
Paul Nahi
John F. Nichols Revocable Trust, under Agreement dated June 12, 1998
Andrew Nichols
PCG Clean Energy & Technology Fund LLC
PCG Clean Energy & Technology Fund (East) LLC
Paul Elliot & Mary E. Elliot
Flextronics International USA, Inc., a California corporation
Compass Horizon Funding Company LLC
Contra Costa Capital, LLC
KPCB Holdings, Inc., as nominee

ENPHASE ENERGY, INC.

AMENDMENT NO. 1 TO INVESTORS' RIGHTS AGREEMENT

This Amendment No. 1 to Investors' Rights Agreement (this "Amendment") is made as of March __, 2011, by and among Enphase Energy, Inc., a Delaware corporation (the "Company"), the investors listed on Schedule A hereto (the "Investors"), and amends that certain Amended and Restated Investors' Rights Agreement dated March 15, 2010, by and among the Company and the Investors (the "Investors' Rights Agreement").

RECITALS

WHEREAS, the Company and the Investors entered into the Investors' Rights Agreement in connection with the sale and issuance of the Company's Series E Preferred Stock pursuant to the Series E Preferred Stock Purchase Agreement dated March 15, 2010, as amended by that certain Amendment No. 1 to Series E Preferred Stock Purchase Agreement dated May 21, 2010;

WHEREAS, in connection with that certain Loan and Security Agreement dated March 11, 2010 (the "Prior Loan Agreement"), between the Company and Horizon Funding Company LLC ("Horizon"), the Company issued to Horizon a warrant to acquire shares of the Company's Preferred Stock (the "Preferred Stock"), dated March 11, 2010 ("Warrant A"), pursuant to which the Company agreed to grant Horizon certain registration rights with respect to the shares of the Company's Common Stock issuable upon conversion of the Preferred Stock issuable upon exercise of Warrant A, which registration rights were granted under the Investors' Rights Agreement;

WHEREAS, in connection with an additional credit facility with Horizon, the Company will issue an additional warrant to acquire shares of Preferred Stock to Horizon ("Warrant B") pursuant to the terms and conditions of that certain Amended and Restated Loan and Security Agreement dated as of March __, 2011, between the Company and Horizon (the "Restated Loan Agreement");

WHEREAS, as a condition to the financing pursuant to the Restated Loan Agreement, the Company has agreed to grant Horizon registration rights with respect to the shares of the Company's Common Stock issuable upon conversion of the Preferred Stock issuable upon exercise of Warrant B (the "Registration Rights"), and the Investors desire to amend the Investors' Rights Agreement to include such Registration Rights thereunder as provided herein; and

WHEREAS, pursuant to Section 4.3 of the Investors' Rights Agreement, this Amendment is being executed by the Company and Investors holding at least 60% of the outstanding shares of Preferred Stock held by the Investors, thereby permitting the Investors' Rights Agreement to be amended by this Amendment.

Now, THEREFORE, for and in consideration of the mutual promises and covenants set forth herein and for other good and valuable consideration, the receipt and sufficiency of which are hereby acknowledged, the parties to this Amendment hereby agree as follows:

AGREEMENT

1. Section 1.1(f) of the Investors' Rights Agreement is amended and restated to read in its entirety as follows:

“(f) The term “Horizon Warrants” means (i) that certain warrant to purchase Preferred Stock of the Company dated March 11, 2010, issued by the Company to Compass Horizon Funding Company LLC (“Horizon”) pursuant to the Venture Loan and Security Agreement by and between the Company and Horizon, dated March 11, 2010, as amended, and (ii) that certain warrant to purchase Preferred Stock of the Company dated March __, 2011, issued by the Company to Horizon pursuant to the Amended and Restated Venture Loan and Security Agreement by and between the Company and Horizon, dated March __, 2011.

2. Section 1.1(k) of the Investors' Rights Agreement is amended and restated to read in its entirety as follows:

“(k) The term “Registrable Securities” means (i) the shares of Common Stock issuable or issued upon conversion of any shares of the Company's Preferred Stock, including Preferred Stock issuable upon exercise of warrants then outstanding; and (ii) any other shares of Common Stock of the Company issued (or issuable upon the conversion or exercise of any warrant, right or other security) to the holders of the shares listed in (i) above; excluding in all cases any Registrable Securities sold by a person in a transaction in which such person's rights under this Agreement are not assigned. Notwithstanding the foregoing, Common Stock or other securities shall only be treated as Registrable Securities if and so long as: (A) they have not been sold to or through a broker or dealer or underwriter in a public distribution or a public securities transaction, (B) they have not been sold in a transaction exempt from the registration and prospectus delivery requirements of the Securities Act under Section 4(1) thereof so that all transfer restrictions, and restrictive legends with respect thereto, if any, are removed upon the consummation of such sale, or (C) the rights of the Holder thereof have not been terminated in accordance with Section 1.15 below. Notwithstanding the foregoing, the shares of Common Stock issuable or issued upon conversion of any shares of the Company's Preferred Stock issuable upon exercise of the Horizon Warrants shall not be deemed Registrable Securities for purposes of Section 1.2;”

3. Effectiveness; Prior Amendment; Continuity of Terms. This Amendment shall be effective when executed by the Company and by the Investors holding at least 60% of the outstanding shares of Preferred Stock held by the Investors. All the other terms and provisions of the Investors' Rights Agreement shall remain in full force and effect.

4. Counterparts. This Amendment may be executed in counterparts all of which together shall constitute one and the same instrument.

[Signature Pages Follow]

IN WITNESS WHEREOF, the parties hereto have executed this Amendment as of the date first written above.

THE COMPANY:

ENPHASE ENERGY, INC.

By: /s/ Paul Nahi
Name: Paul Nahi
Title: President and CEO

**ENPHASE ENERGY, INC.
AMENDMENT TO INVESTORS' RIGHTS AGREEMENT**

IN WITNESS WHEREOF, the parties hereto have executed this Amendment as of the date first written above.

INVESTORS:

BAY PARTNERS XI, L.P.

By: Bay Management Company XI, LLC, General Partner

By: /s/ Neal Dempsey
Name: Neal Dempsey
Title: Manager

BAY PARTNERS XI PARALLEL FUND, L.P.

By: Bay Management Company XI, LLC, General Partner

By: /s/ Neal Dempsey
Name: Neal Dempsey
Title: Manager

Address: 490 South California Avenue, Suite 200
Palo Alto, CA 94306

**ENPHASE ENERGY, INC.
AMENDMENT TO INVESTORS' RIGHTS AGREEMENT**

IN WITNESS WHEREOF, the parties hereto have executed this Amendment as of the date first written above.

INVESTORS:

MADRONE PARTNERS, L.P.

By: Madrone Capital Partners, LLC, its General Partner

By: /s/ Jamie McJunkin
Name: Jamie McJunkin
Title: Managing Member

Address: 3000 Sand Hill Road
Building 1, Suite 150
Menlo Park, CA 94025

**ENPHASE ENERGY, INC.
AMENDMENT TO INVESTORS' RIGHTS AGREEMENT**

IN WITNESS WHEREOF, the parties hereto have executed this Amendment as of the date first written above.

INVESTORS:

THIRD POINT PARTNERS QUALIFIED L.P.
THIRD POINT PARTNERS L.P.
THIRD POINT OFFSHORE MASTER FUND L.P.
THIRD POINT ULTRA MASTER FUND L.P.

By: Third Point LLC

By: /s/ James Gallagher

Name: James Gallagher

Title: CAO

Address: c/o Third Point LLC
390 Park Ave., 18th Floor
New York, NY 10022
Attn: James P. Gallagher

ENPHASE ENERGY, INC.
AMENDMENT TO INVESTORS' RIGHTS AGREEMENT

IN WITNESS WHEREOF, the parties hereto have executed this Amendment as of the date first written above.

INVESTORS:

ROCKPORT CAPITAL PARTNERS II, L.P.

By: RockPort Capital II, L.L.C., its General Partner

By: /s/ Stoddard Wilson

Name: Stoddard Wilson

Title: Managing Member

Address: c/o RockPort Capital
160 Federal Street
18th Floor
Boston, MA 02110-1700

**ENPHASE ENERGY, INC.
AMENDMENT TO INVESTORS' RIGHTS AGREEMENT**

IN WITNESS WHEREOF, the parties hereto have executed this Amendment as of the date first written above.

INVESTORS:

KPCB HOLDINGS, INC., AS NOMINEE

By: /s/ John Denniston
Name: John Denniston
Title: Senior Vice President

Address: 2750 Sand Hill Road
Menlo Park, CA 94025

**ENPHASE ENERGY, INC.
AMENDMENT TO INVESTORS' RIGHTS AGREEMENT**

IN WITNESS WHEREOF, the parties hereto have executed this Amendment as of the date first written above.

INVESTORS:

By: _____
Paul Nahi

By: /s/ Raghuv​eer Belur
Raghuv​eer Belur

By: _____
Martin Fornage

**ENPHASE ENERGY, INC.
AMENDMENT TO INVESTORS' RIGHTS AGREEMENT**

Schedule A

Investors

Bay Partners XI, L.P.
Bay Partners XI Parallel Fund, L.P.
Madrone Partners, L.P.
RockPort Capital Partners II, LP
Third Point Partners Qualified L.P.
Third Point Partners L.P.
Third Point Offshore Master Fund L.P.
Third Point Ultra Master Fund L.P.
TGI Holdings, LLC
James A. Stern Trust F/B/O Peter Stern
James A. Stern Trust F/B/O David Stern
Thomas G. Mendell
Emil Meshberg
Applied Ventures, LLC
ATEL Ventures, Inc. as Trustee
Raghuv eer Belur
Tom Birdsall and Rebecca Green
Martin Fornage
G&W Ventures
Green Ventures Capital II
Michael Hatfield
J. Rick Johnston
Ted Lord
Steve Milborrow
William Orenstein
Ellen Schwab
Redstone Investments LLC
J. Steve Sheppard
F&W Investments LLC – Series 2006
Daniel Loeb
Timothy Lash
Robert Schwartz
Brian Hamel
Ray Moser
David Fisher
Restatement of James H. Carstensen 1995 Revocable Trust dated, March 13, 2000
Ed Falsetti
Paul Nahi
John F. Nichols Revocable Trust, under Agreement dated June 12, 1998
Andrew Nichols
CalPERS Clean Energy & Technology Fund, LLC
PCG Clean Energy & Technology Fund (East) LLC
Paul Elliot & Mary E. Elliot
Flextronics International USA, Inc., a California corporation
Compass Horizon Funding Company LLC
Contra Costa Capital, LLC
KPCB Holdings, Inc., as nominee

WARRANT

THIS WARRANT AND THE SHARES ISSUABLE HEREUNDER HAVE NOT BEEN REGISTERED UNDER THE SECURITIES ACT OF 1933, AS AMENDED, OR APPLICABLE STATE SECURITIES LAWS AND MAY NOT BE SOLD, ASSIGNED OR TRANSFERRED WITHOUT AN EFFECTIVE REGISTRATION STATEMENT FOR SUCH SECURITY OR SECURITIES UNDER THE SECURITIES ACT OF 1933 AND APPLICABLE STATE SECURITIES LAWS, UNLESS THE COMPANY HAS RECEIVED THE WRITTEN OPINION OF COUNSEL SATISFACTORY TO THE COMPANY THAT SUCH COUNSEL IS OF THE OPINION THAT SUCH SALE, ASSIGNMENT OR TRANSFER DOES NOT INVOLVE A TRANSACTION REQUIRING THE REGISTRATION OF SUCH SECURITY OR SECURITIES UNDER THE SECURITIES ACT OF 1933 OR APPLICABLE STATE SECURITIES LAWS.

ENPHASE ENERGY, INC.
COMMON STOCK PURCHASE WARRANT

Issue Date: March 4, 2010
Expiration Date: December 31, 2012

100,000 Shares

THIS WARRANT CERTIFIES THAT, for good and valuable consideration, receipt of which is hereby acknowledged, MS Solar Solutions, Corp. or its assigns (each, a **"Holder"**) is entitled to purchase up to one-hundred-thousand (100,000) fully paid and nonassessable shares of Common Stock, \$0.00001 par value per share (the **"Shares"**), but in any event not more than 4.9% of the issued and outstanding Shares, of Enphase Energy, Inc. (the **"Company"**), a Delaware corporation, at the initial exercise price per Share of \$0.50 (the **"Warrant Price"**) as adjusted pursuant to Article 2 of this Warrant, subject to the provisions and upon the terms and conditions set forth in this Warrant.

ARTICLE 1. EXERCISE**1.1 Method of Exercise.**

(a) In the event Holder has purchased at least 200,000 micro-inverters from the Company within 24 months from the Issue Date (the "Completion Vesting Date"), then at any time before 5:00 p.m. Eastern time on the date that is 12 months after the Completion Vesting Date, Holder may exercise this Warrant in whole or in part by surrendering this Warrant and delivering to the principal office of the Company a duly executed Notice of Exercise in substantially the form attached as Appendix 1 and a check for the Warrant Price multiplied by the number of Shares being purchased.

(b) Notwithstanding anything to the contrary in this Warrant, in the event that Holder has purchased at least 100,000 micro-inverters, but less than 200,000 micro-inverters, as of the date of a Change of Control of Company (the "Change of Control Vesting Date"), then at any time before 5:00 p.m. Eastern time on the date that is 12 months after the Change of Control Vesting Date, Holder may exercise this Warrant on a pro-rata basis, based on the number of micro-inverters purchased by Holder as of the Change of Control Vesting Date. As a non-limiting example, if Holder has purchased 150,000 micro-inverters (i.e., 75% of 200,000 units) at the Change of Control Vesting Date, Holder may exercise this Warrant to purchase all or a portion of 75,000 shares (i.e., 75% of 100,000 shares). The Company

shall notify Holder of a Change of Control within 3 business days from the date of such Change of Control. A "Change of Control" shall mean the closing of any merger, consolidation or other transaction, or series of transactions pursuant to which, in the aggregate, 50% or more of the voting power of the outstanding capital stock of the Company, or all or substantially all of the assets of the Company, shall have been sold, leased, transferred, conveyed, licensed or otherwise disposed to any third party.

The Company and Holder understand and acknowledge that certain of the Company's products (e.g., Twin-Pack) contain two micro-inverters in each Product purchased. In such case, a purchase of one module (e.g., Twin-Pack) shall count as the purchase of two micro-inverters.

1.2 Delivery of Certificate and New Warrant. Promptly after Holder exercises this Warrant, the Company shall deliver to Holder certificates for the Shares acquired and, if this Warrant has not been fully exercised and has not expired, a new warrant in substantially identical form representing the Shares not so acquired.

1.3 Replacement of Warrants. On receipt of evidence reasonably satisfactory to the Company of the loss, theft, destruction or mutilation of this Warrant and, in the case of loss, theft or destruction, on delivery of an indemnity agreement reasonably satisfactory in form and amount to the Company or, in the case of mutilation, or surrender and cancellation of this Warrant, the Company at its expense shall execute and deliver, in lieu of this Warrant a new warrant in substantially identical form.

ARTICLE 2. ADJUSTMENTS TO THE SHARES.

2.1 Reclassification, etc. In case at any time or from time to time, the holders of Common Stock shall have received, or (on or after the record date fixed for the determination of shareholders eligible to receive) shall have become entitled to receive, without payment therefor, other or additional stock or other securities or property by way of spin-off, split up, reclassification, recapitalization or similar corporate rearrangement, other than additional shares of Common Stock issued as a stock dividend or in a stock-split or combination of shares (adjustments in respect of which are provided for in Section 2.3), then and in each such case the Holder, on the exercise hereof as provided in Section 1, shall be entitled to receive the amount of stock and other securities and property that such Holder would hold on the date of such exercise if on the date hereof he had been the holder of record of the number of Shares called for on the face of this Warrant and had thereafter, during the period from the date hereof to and including the date of such exercise, retained such Shares and all such other or additional stock and other securities, cash and property receivable by him as aforesaid during such period, giving effect to all adjustments called for during such period by Sections 2.2 and 2.3.

2.2 Adjustment for Reorganization, Consolidation, Merger, etc.

2.2.1 In case at any time or from time to time, the Company shall (a) effect a reorganization, (b) consolidate with or merge into any other entity, or (c) transfer all or substantially all of its properties or assets to any other person under any plan or arrangement contemplating the dissolution of the Company, then, in each such case, upon the exercise hereof as provided in Section 1 at any time after the consummation of such reorganization, consolidation or merger or the effective date of such dissolution, as the case may be (but not after the Expiration Date), the Holder shall receive, in lieu of the Shares issuable on such exercise before such consummation or effective date, the stock and other securities and property to which the Holder would have been entitled upon such consummation or in connection with such dissolution, as the case may be, if such Holder had so exercised this Warrant, immediately before such date, all subject to further adjustment thereafter as provided in Sections 2.1 and

The provisions of this Section 2.2.1 shall similarly apply to successive reorganizations, consolidations, mergers, sales and transfers and to the stock or securities of any other corporation that are at the time receivable upon the exercise of this Warrant. If the per-share consideration payable to the Holder for shares in connection with any such transaction is in a form other than cash or marketable securities, then the value of such consideration shall be determined in good faith by the Company and Holder. In all events, appropriate adjustment shall be made in the application of the provisions of this Warrant with respect to the rights and interest of the Holder after the transaction, to the end that the provisions of this Warrant shall be applicable after that event, as near as reasonably may be, in relation to any shares or other property deliverable after that event upon exercise of this Warrant.

2.2.2 Continuation of Terms. Upon any reorganization, consolidation, merger or transfer (and any dissolution following any transfer) referred to in Section 2.2.1, this Warrant shall continue in full force and effect and the terms hereof shall be applicable to the shares of stock and other securities and property receivable on the exercise of this Warrant after the consummation of such reorganization, consolidation or merger or the effective date of dissolution following any such transfer, as the case may be, and shall be binding upon the issuer of any such stock or other securities, including, in the case of any such transfer, the person acquiring all or substantially all of the properties or assets of the Company, whether or not such person shall have expressly assumed the terms of this Warrant.

2.3 Adjustment Upon Extraordinary Events. In the event that the Company shall (a) issue additional shares of Common Stock as a dividend or other distribution on outstanding Common Stock, (b) subdivide its outstanding shares of Common Stock, or (c) combine its outstanding shares of Common Stock into a smaller number of shares of Common Stock, then, in each such event, the Warrant Price shall, simultaneously with the happening of such event, be adjusted by multiplying the then Warrant Price by a fraction, the numerator of which shall be the number of shares of Common Stock outstanding immediately before such event and the denominator of which shall be the number of shares of Common Stock outstanding immediately after such event and the product so obtained shall thereafter be the Warrant Price then in effect. The Warrant Price, as so adjusted, shall be readjusted in the same manner upon the happening of any successive event or events described in this Section 2.3. Holder shall thereafter, on the exercise hereof as provided in Section 1, be entitled to receive that number of shares of Common Stock determined by multiplying the number of Shares that would otherwise (but for the provisions of this Section 2.3) be issuable on such exercise by a fraction of which (i) the numerator is the Warrant Price that would otherwise (but for the provisions of this Subsection 2.3) be in effect, and (ii) the denominator is the Warrant Price in effect on the date of such exercise.

2.4 No Impairment. The Company shall not, by amendment of its Certificate of Incorporation or through a reorganization, transfer of assets, consolidation, merger, dissolution, issue, or sale of securities or any other voluntary action, avoid or seek to avoid the observance or performance of any of the terms to be observed or performed under this Warrant by the Company, but shall at all times in good faith assist in carrying out of all the provisions of this Article 2 and in taking all such action as may be necessary or appropriate to protect Holder's rights under this Warrant against impairment. If the Company takes any action affecting the Shares other than as described above that adversely affects Holder's rights under this Warrant, the Warrant Price shall be adjusted downward and the number of Shares issuable upon exercise of this Warrant shall be adjusted upward in such a manner that the aggregate Warrant Price of this Warrant is unchanged.

2.5 Fractional Shares. No fractional Shares shall be issuable upon exercise of the Warrant and the number of Shares to be issued shall be rounded down to the nearest whole Share. If a fractional share interest arises upon any exercise of the Warrant, the Company shall eliminate such fractional share

interest by paying the Holder an amount computed by multiplying the fractional interest by the fair market value of a full Share on the date of exercise.

2.6 Certificate as to Adjustments. Upon each adjustment of the Warrant Price and/or number of Shares, the Company at its expense shall promptly compute such adjustment, and furnish Holder with a certificate of an officer of the Company setting forth such adjustment and the facts upon which such adjustment is based. The Company shall, upon written request, furnish Holder a certificate setting forth the Warrant Price in effect upon the date thereof and the series of adjustments leading to such Warrant Price.

ARTICLE 3. REPRESENTATIONS AND COVENANTS OF THE COMPANY.

3.1 Representations and Warranties. The Company hereby represents and warrants to the Holder that all Shares that may be issued upon the exercise of the purchase right represented by this Warrant, and all securities shall, upon issuance in accordance with the terms of this Warrant, be duly authorized, validly issued, fully paid and nonassessable, and free of any liens and encumbrances except for restrictions on transfer under applicable federal and state securities laws.

3.2 Reservation of Stock, etc., Issuable on Exercise of Warrants. The Company shall at all times reserve and keep available, solely for issuance and delivery on the exercise of this Warrant, all shares of Common Stock from time to time issuable on such exercise.

3.3 Notice of Certain Events. If the Company proposes at any time (a) to declare any dividend or distribution upon any class of its securities, whether in cash, property, stock, or other securities and whether or not a regular cash dividend; (b) to offer for subscription pro rata to the holders of any class or series of its stock any additional shares of stock of any class or series or other rights or securities; (c) to effect any reorganization, reclassification or recapitalization of the common stock or any other security; or (d) to merge or consolidate with or into any other entity, or sell, lease, license, or convey all or substantially all of its assets, or to liquidate, dissolve or wind up, then, in connection with each such event, the Company shall give Holder (1) at least 5 days' prior written notice of the date on which a record will be taken for such dividend, distribution, or subscription rights (and specifying the date on which the holders of common stock will be entitled thereto) or for determining rights to vote, if any, in respect of the matters referred to in (c) and (d) above; and (2) in the case of the matters referred to in (c) and (d) above at least 5 days' prior written notice of the date when the same will take place. In the case the Company consummates the matter referred to in (d) above before the Warrant is exercised, the Company shall reserve cash sufficient to fulfill its obligations to Holder under Section 2.2.

ARTICLE 4. COVENANTS OF THE HOLDER.

4.1 Lock-Up Agreement.

(a) Lock-Up Period; Agreement. The Holder hereby agrees that it shall not, to the extent requested by the managing underwriter of securities of the Company, sell or otherwise transfer or dispose of any Shares or other shares of stock of the Company then owned by such Holder (other than to donees or partners of the Holder who agree to be similarly bound) for up to one hundred eighty (180) days following the effective date of any registration statement of the Company filed under the Securities Act of 1933, as amended; provided however that, if during the last 17 days of the restricted period the Company issues an earnings release or material news or a material event relating to the Company occurs, or prior to the expiration of the restricted period the Company announces that it will

release earnings results during the 16-day period beginning on the last day of the restricted period, and if the Company's securities are listed on the Nasdaq Stock Market and Rule 2711(f)(4) thereof applies, then the managing underwriter may require by written notice that the restrictions imposed by this Section 4.1 shall continue to apply until the expiration of the 18-day period beginning on the issuance of the earnings release or the occurrence of the material news or material event. In no event will the restricted period extend beyond two hundred and fifteen (215) days after the effective date of the registration statement.

(b) Limitations. The obligations described in subsection 4.1(a):

(i) apply only to the Company's initial public offering;

(ii) will not apply unless all executive officers and directors of the Company then holding Common Stock of the Company and all stockholders then holding in the aggregate at least 1% of the total equity of the Company, enter into substantially identical agreements; and

(iii) will not apply to any shares purchased pursuant to such registration statement by a Holder.

(c) Further Assurances. The Holder further agrees to enter into any agreement that is consistent with this Section 4.1 and reasonably required by the underwriters to implement this Section 4.1 within any reasonable timeframe so requested.

ARTICLE 5. MISCELLANEOUS.

5.1 Legends. This Warrant and the Shares shall be imprinted with a legend in substantially the following form:

THIS SECURITY HAS NOT BEEN REGISTERED UNDER THE SECURITIES ACT OF 1933, AS AMENDED, OR APPLICABLE STATE SECURITIES LAWS AND MAY NOT BE SOLD, ASSIGNED OR TRANSFERRED WITHOUT AN EFFECTIVE REGISTRATION STATEMENT FOR SUCH SECURITY OR SECURITIES UNDER THE SECURITIES ACT OF 1933 AND APPLICABLE STATE SECURITIES LAWS, UNLESS THE COMPANY HAS RECEIVED THE WRITTEN OPINION OF COUNSEL SATISFACTORY TO THE COMPANY THAT SUCH COUNSEL IS OF THE OPINION THAT SUCH SALE, ASSIGNMENT OR TRANSFER DOES NOT INVOLVE A TRANSACTION REQUIRING THE REGISTRATION OF SUCH SECURITY OR SECURITIES UNDER THE SECURITIES ACT OF 1933 OR APPLICABLE STATE SECURITIES LAWS.

5.2 Transfers. Subject to the restrictions on transfer provided for under applicable federal and state securities laws, this Warrant and all rights hereunder may be transferred by the Holder in whole or in part upon the books of the Company by Holder, and a new Warrant or Warrants, of the same tenor as this Warrant but registered in the name of the transferee or transferees shall be made and delivered by the Company upon surrender of this Warrant duly endorsed, at the office of the Company.

5.3 No Rights as Stockholder. Except as provided herein, this Warrant does not entitle the Holder to any voting rights as a stockholder of the Company prior to the exercise of this Warrant.

5.4 Notices. Unless otherwise provided, any notice required or permitted hereunder shall be given in writing and shall be deemed effectively given upon personal delivery to the party to be notified, or when sent by telecopier or electronic mail (with receipt confirmed and promptly confirmed by personal delivery, U.S. first class mail, or courier), or upon receipt from overnight courier service, with fees prepaid and addressed to the party to be notified, or five (5) days after deposit with the United States Post

Office, by registered or certified mail, postage prepaid and addressed to the party to be notified at the address indicated for such party on the signature page hereof, or at such other address as such party may designate by ten (10) days' advance written notice to the other parties in the manner set forth in this Section 5.4.

5.5 Waiver. This Warrant and any term hereof may be changed, waived, discharged or terminated only by an instrument in writing signed by the party against which enforcement of such change, waiver, discharge or termination is sought.

5.6 Attorneys Fees. In the event of any dispute between the parties concerning the terms and provisions of this Warrant, the party prevailing in such dispute shall be entitled to collect from the other party all costs incurred in such dispute, including reasonable attorneys' fees.

5.7 Governing Law. This Warrant shall be governed by and construed in accordance with the laws of the State of Delaware, without giving effect to its principles regarding conflicts of law.

5.8 Automatic Termination. This Warrant shall automatically terminate and no longer be exercisable in the event (a) the Holder fails to purchase at least 200,000 micro-inverters from Company within 24 months from the Issue Date, (b) the Holder fails to purchase at least 100,000 micro-inverters from Company as of the date of a Change of Control, or (c) that Holder fails to exercise this Warrant within 12 months from the Completion Vesting Date or the Change of Control Vesting Date, as applicable. The Expiration Date shall be extended to the extent required permit the exercise of this Warrant during the 12-month time period referenced in clause (c) of the previous sentence.

COMPANY

ENPHASE ENERGY, INC.

By: /s/ Sanjeev Kumar

Name: Sanjeev Kumar

Title: CFO

APPENDIX 1

NOTICE OF EXERCISE

The undersigned hereby elects to purchase _____ shares of the Common Stock of Enphase Energy, Inc. pursuant to the terms of the attached Warrant, and tenders herewith payment of the purchase price of such shares in full.

Please issue a certificate or certificates representing said shares in the name of the undersigned or in such other name as is specified below:

(Name)

(Address)

The undersigned represents it is acquiring the shares solely for its own account and not as a nominee for any other party and not with a view toward the resale or distribution thereof except in compliance with applicable securities laws.

(Signature)

(Date)

THIS WARRANT HAS NOT BEEN REGISTERED UNDER THE SECURITIES ACT OF 1933, AS AMENDED OR ANY STATE SECURITIES LAWS. NO SALE OR DISPOSITION MAY BE EFFECTED WITHOUT (i) EFFECTIVE REGISTRATION STATEMENTS RELATED THERETO, (ii) AN OPINION OF COUNSEL OR OTHER EVIDENCE, REASONABLY SATISFACTORY TO THE COMPANY, THAT SUCH REGISTRATIONS ARE NOT REQUIRED, (iii) RECEIPT OF NO-ACTION LETTERS FROM APPROPRIATE GOVERNMENTAL AUTHORITIES, OR (iv) OTHERWISE COMPLYING WITH THE PROVISIONS OF SECTION 7 OF THIS WARRANT.

ENPHASE ENERGY, INC.

WARRANT TO PURCHASE SHARES
OF SERIES PREFERRED STOCK

THIS CERTIFIES THAT, for value received, COMPASS HORIZON FUNDING COMPANY LLC and its assignees are entitled to subscribe for and purchase that number of the fully paid and nonassessable shares of Series Preferred Stock (as adjusted pursuant to Section 4 hereof, the "Shares") of ENPHASE ENERGY, INC., a Delaware corporation (the "Company"), as is determined pursuant to the next paragraph hereof at the price per share as is determined pursuant to the next paragraph hereof (such price and such other price as shall result, from time to time, from the adjustments specified in Section 4 hereof is herein referred to as the "Warrant Price"), subject to the provisions and upon the terms and conditions hereinafter set forth. As used herein, (a) the term "Series Preferred" shall mean the Company's Series Preferred Stock sold in the next Qualified Financing (as defined below), and any stock into or for which such Series Preferred Stock may hereafter be converted or exchanged, and after the automatic conversion of the Series Preferred Stock to Common Stock shall mean the Company's Common Stock and (b) the term "Date of Grant" shall mean March 11, 2010. The term "Warrant" as used herein shall be deemed to include any warrant issued upon transfer or partial exercise of or in lieu of this Warrant, unless the context clearly requires otherwise.

The Warrant Price shall be the lowest effective price per share (on a common stock equivalent basis and taking into account any securities issued together with the preferred stock) at which shares of the Company's convertible preferred stock are sold in a Qualified Financing. A "Qualified Financing" shall mean the sale of the convertible preferred stock of the Company to purchasers which include venture capital investors in an aggregate cash amount not less than \$15,000,000. The number of shares for which this Warrant is exercisable shall be the nearest whole number determined by dividing Seven Hundred Thousand and 00/100 Dollars (\$700,000) by the Warrant Price determined pursuant to this paragraph; *provided, however*, if an Acquisition Transaction (as set forth in Section 10.1 hereof) or an IPO (as defined below) occurs prior to a Qualified Financing, then the Warrant Price shall be \$0.235 and this Warrant shall be exercisable for 2,978,723 shares of the Company's Series D Preferred Stock and any stock into or for which such Series D Preferred Stock may hereafter be converted or exchanged, and after the automatic conversion of the Series D Preferred Stock to Common Stock shall mean the Company's Common Stock.

1. Term. The purchase right represented by this Warrant is exercisable, in whole or in part, at any time and from time to time from the Date of Grant through the later of (i) ten (10) years after the Date of Grant or (ii) five (5) years after the closing of the Company's initial public offering of its Common Stock ("IPO") effected pursuant to a Registration Statement on Form S-1 (or its successor) filed under the Securities Act of 1933, as amended (the "Act").

2. Method of Exercise; Payment; Issuance of New Warrant. Subject to Section 1 hereof, the purchase right represented by this Warrant may be exercised by the holder hereof, in whole or in part and from time to time, at the election of the holder hereof, by (a) the surrender of this Warrant (with the notice of exercise substantially in the form attached hereto as Exhibit A-1 duly completed and executed) at the principal office of the Company and by the payment to the Company, by certified or bank check, or by wire transfer to an account designated by the Company (a "Wire Transfer") of an amount equal to the then applicable Warrant Price multiplied by the number of Shares then being purchased; (b) if in connection with a registered public offering of the Company's securities, the surrender of this Warrant (with the notice of exercise form attached hereto as Exhibit A-2 duly completed and executed) at the principal office of the Company together with notice of arrangements reasonably satisfactory to the Company for payment to the Company either by certified or bank check or by Wire Transfer from the proceeds of the sale of shares to be sold by the holder in such public offering of an amount equal to the then applicable Warrant Price per share multiplied by the number of Shares then being purchased; or (c) exercise of the "net issuance" right provided for in Section 10.2 hereof. The person or persons in whose name(s) any certificate(s) representing shares of Series Preferred shall be issuable upon exercise of this Warrant shall be deemed to have become the holder(s) of record of, and shall be treated for all purposes as the record holder(s) of, the shares represented thereby (and such shares shall be deemed to have been issued) immediately prior to the close of business on the date or dates upon which this Warrant is exercised. In the event of any exercise of the rights represented by this Warrant, certificates for the shares of stock so purchased shall be delivered to the holder hereof as soon as possible and in any event within thirty (30) days after such exercise and, unless this Warrant has been fully exercised or expired, a new Warrant representing the portion of the Shares, if any, with respect to which this Warrant shall not then have been exercised shall also be issued to the holder hereof as soon as possible and in any event within such thirty day period; provided, however, at such time as the Company is subject to the reporting requirements of the Securities Exchange Act of 1934, as amended, if requested by the holder of this Warrant, the Company shall cause its transfer agent to deliver the certificate representing Shares issued upon exercise of this Warrant to a broker or other person (as directed by the holder exercising this Warrant) within the time period required to settle any trade made by the holder after exercise of this Warrant.

3. Stock Fully Paid; Reservation of Shares. All Shares that may be issued upon the exercise of the rights represented by this Warrant will, upon issuance pursuant to the terms and conditions herein, be fully paid and nonassessable, and free from all preemptive rights and taxes, liens and charges with respect to the issue thereof. During the period within which the rights represented by this Warrant may be exercised, the Company will at all times have authorized, and reserved for the purpose of the issue upon exercise of the purchase rights evidenced by this Warrant, a sufficient number of shares of its Series Preferred to provide for the exercise of the rights

represented by this Warrant and a sufficient number of shares of its Common Stock to provide for the conversion of the Series Preferred into Common Stock.

4. Adjustment of Warrant Price and Number of Shares. The number and kind of securities purchasable upon the exercise of this Warrant and the Warrant Price shall be subject to adjustment from time to time upon the occurrence of certain events, as follows:

(a) Reclassification or Merger. In case of any reclassification or change of securities of the class issuable upon exercise of this Warrant (other than a change in par value, or from par value to no par value, or from no par value to par value, or as a result of a subdivision or combination), or in case of any merger of the Company with or into another corporation (other than a merger with another corporation in which the Company is the acquiring and the surviving corporation and which does not result in any reclassification or change of outstanding securities issuable upon exercise of this Warrant), or in case of any sale of all or substantially all of the assets of the Company, the Company, or such successor or purchasing corporation, as the case may be, shall duly execute and deliver to the holder of this Warrant a new Warrant (in form and substance satisfactory to the holder of this Warrant), so that the holder of this Warrant shall have the right to receive upon exercise of this Warrant, at a total purchase price not to exceed that payable upon the exercise of the unexercised portion of this Warrant, and in lieu of the shares of Series Preferred theretofore issuable upon exercise of this Warrant, (i) the kind and amount of shares of stock, other securities, money and property receivable upon such reclassification, change, merger or sale by a holder of the number of shares of Series Preferred then purchasable under this Warrant, or (ii) in the case of such a merger or sale in which the consideration paid consists all or in part of assets other than securities of the successor or purchasing corporation, at the option of the holder of this Warrant, the securities of the successor or purchasing corporation having a value at the time of the transaction equivalent to the value of the Series purchasable upon exercise of this Warrant at the time of the transaction. Any new Warrant shall provide for adjustments that shall be as nearly equivalent as may be practicable to the adjustments provided for in this Section 4. The provisions of this Section 4(a) shall similarly apply to successive classifications, changes, mergers and sales.

(b) Subdivision or Condition of Shares. If the Company at any time while this Warrant remains outstanding and unexpired shall subdivide or combine its outstanding shares of Series Preferred, the Warrant Price shall be proportionately decreased and the number of Shares issuable hereunder shall be proportionately increased in the case of a subdivision and the Warrant Price shall be proportionately increased and the number of Shares issuable hereunder shall be proportionately decreased in the case of a combination.

(c) Stock, Dividends and Other Distributions. If the Company at any time while this Warrant is outstanding and unexpired shall (i) pay a dividend with respect to Series Preferred payable in Series Preferred, then the Warrant Price shall be adjusted, from and after the date of determination of shareholders entitled to receive such dividend or distribution, to that price determined by multiplying the Warrant Price in effect immediately prior to such date of determination by a fraction (A) the numerator of which shall be the total number of shares of Series Preferred outstanding immediately prior to such dividend or distribution, and (B) the denominator of which shall be the total number of shares of Series Preferred outstanding immediately after such

dividend or distribution; or (ii) make any other distribution with respect to Series Preferred (except any distribution specifically provided for in Sections 4(a) and 4(b)), then, in each such case, provision shall be made by the Company such that the holder of this Warrant shall receive upon exercise of this Warrant a proportionate share of any such dividend or distribution as through it were the holder of the Series Preferred (or Common Stock issuable upon conversion thereof) as of the record date fixed for the determination of the shareholders of the Company entitled to receive such dividend or distribution.

(d) Adjustment of Number of Shares. Upon each adjustment in the Warrant Price, the number of Shares of Series Preferred purchasable hereunder shall be adjusted, to the nearest whole share, to the product obtained by multiplying the number of Shares purchasable immediately prior to such adjustment in the Warrant Price by a fraction, the numerator of which shall be the Warrant Price immediately prior to such adjustment and the denominator of which shall be the Warrant Price immediately thereafter.

(e) Antidilution Rights. The other antidilution rights applicable to the Shares of Series Preferred purchasable hereunder are set forth in the Company's Certificate of Incorporation, as amended from time to time (the "Charter"). Such antidilution rights shall not be restated, amended, modified or waived in any manner that treats the holder hereof adversely to other holders of the class and series of the Company's capital stock for which this Warrant is exercisable without such holder's prior written consent. The Company shall promptly provide the holder hereof with any restatement, amendment, modification or waiver of the Charter promptly after the same has been made.

5. Notice of Adjustments. Whenever the Warrant Price or the number of Shares purchasable hereunder shall be adjusted pursuant to Section 4 hereof, the Company shall make a certificate signed by its chief financial officer setting forth, in reasonable detail, the event requiring the adjustment, the amount of the adjustment, the method by which such adjustment was calculated, and the Warrant Price and the number of shares purchasable hereunder after giving effect to such adjustment, and shall cause copies of such certificate to be mailed (without regard to Section 13 hereof, by first class mail, postage prepaid) to the holder of this Warrant. In addition, whenever the conversion price or conversion ratio of the Series Preferred shall be adjusted, the Company shall make a certificate signed by its chief financial officer setting forth, in reasonable detail, the event requiring the adjustment, the amount of the adjustment, the method by which such adjustment was calculated, and the conversion price or ratio of the Series Preferred after giving effect to such adjustment, and shall cause copies of such certificate to be mailed (without regard to Section 13 hereof, by first class mail, postage prepaid) to the holder of this Warrant.

6. Fractional Shares. No fractional shares of Series Preferred will be issued in connection with any exercise hereunder, but in lieu of such fractional shares the Company shall make a cash payment therefor on the fair market value of the Series Preferred on the date of exercise as reasonably determined in good faith by the Company's Board of Directors.

7. Compliance with Act; Disposition of Warrant or Shares of Series Preferred.

(a) Compliance with Act. The holder of this Warrant, by acceptance hereof, agrees that this Warrant, and the shares of Series Preferred to be issued upon exercise hereof and any Common Stock issued upon conversion thereof are being acquired for investment and that such holder will not offer, sell or otherwise dispose of this Warrant, or any shares of Series Preferred to be issued upon exercise hereof or any Common Stock issued upon conversion thereof except under circumstances which will not result in a violation of the Act or any applicable state securities laws. Upon exercise of this Warrant, unless the Shares being acquired are registered under the Act and any applicable state securities laws or an exemption from such registration is available, the holder hereof shall confirm in writing that the shares of Series Preferred so purchased (and any shares of Common Stock issued upon conversion thereof) are being acquired for investment and not with a view toward distribution or resale in violation of the Act and shall confirm such other matters related thereto as may be reasonably requested by the Company. This Warrant and all shares of Series Preferred issued upon exercise of this Warrant and all shares of Common Stock issued upon conversion thereof (unless registered under the Act and any applicable state securities laws) shall be stamped or imprinted with a legend in substantially the following form.

“THE SECURITIES EVIDENCED HEREBY HAVE NOT BEEN REGISTERED UNDER THE SECURITIES ACT OF 1933, AS AMENDED, OR ANY STATE SECURITIES LAWS. NO SALE OR DISPOSITION MAY BE EFFECTED WITHOUT (i) EFFECTIVE REGISTRATION STATEMENTS RELATED THERETO, (ii) AN OPINION OF COUNSEL OR OTHER EVIDENCE, REASONABLY SATISFACTORY TO THE COMPANY, THAT SUCH REGISTRATIONS ARE NOT REQUIRED, (iii) RECEIPT OF NO-ACTION LETTERS FROM THE APPROPRIATE GOVERNMENTAL AUTHORITIES, OR (iv) OTHERWISE COMPLYING WITH THE PROVISIONS OF SECTION 7 OF THE WARRANT UNDER WHICH THESE SECURITIES WERE ISSUED, DIRECTLY OR INDIRECTLY.”

Said legend shall be removed the Company, upon the request of a holder, at such time as the restrictions on the transfer of the applicable security shall have terminated. In addition, in connection with the issuance of this Warrant, holder specifically represents to the Company by acceptance of this Warrants as follows:

- (1) The holder is aware of the Company’s business affairs and financial condition, and has acquired information about the Company sufficient to reach an informed and knowledgeable decision to acquire this Warrant. The holder is acquiring this Warrant for its own account for investment purposes only and not with a view to, or for the resale in connection with, any “distribution” thereof in violation the Act.
- (2) The holder understands that this Warrant has not been registered under the Act in reliance upon a specific exemption therefrom, which exemption depends upon, among other, the bona fide nature of the holder’s investment intent as expressed herein.
- (3) The holder further understands that this Warrant must be held indefinitely unless subsequently registered under the Act and qualified under any applicable state security laws, or unless exemptions from registration and qualification are otherwise available. The holder is aware of the provisions of Rule 144, promulgated under the Act.

(4) The holder is an “accredited investor” as such term is defined in Rule 501 of Regulation D promulgated under the Act.

(b) Disposition of Warrant or Shares. With respect to any offer, sale or other disposition of this Warrant or any shares of Series Preferred acquired pursuant to the exercise of this Warrant prior to registration of such Warrant or shares, the holder hereof agrees to give written notice to the Company prior thereto, describing briefly the manner thereof, together with a written opinion of such holder’s counsel, or other evidence, if reasonably satisfactory to the Company, to the effect that such offer, sale or other disposition may be effected without registration or qualification (under the Act as then in effect or any federal or state securities law then in effect) of this Warrant or such shares of Series Preferred or Common Stock and indicating whether or not under the Act certificates for this Warrant or such shares of Series Preferred to be sold or otherwise disposed of require any restrictive legend as to applicable restrictions on transferability in order to ensure compliance with such law. Upon receiving such written notice and reasonably satisfactory opinion or other evidence, the Company, as promptly as practicable but no later than fifteen (15) days after receipt of the written notice, shall notify such holder that such holder may sell or otherwise dispose of this Warrant or such shares of Series Preferred or Common Stock, all in accordance with the terms of the notice delivered to the Company. If a determination has been made pursuant to this Section 7(b) that the opinion of counsel for the holder or other evidence is not reasonably satisfactory to the Company, the Company shall so notify the holder promptly with details thereof after such determination has been made. Notwithstanding the foregoing, this Warrant or such shares of Series Preferred or Common Stock may, as to such federal laws, be offered, sold or otherwise disposed of in accordance with Rule 144 or 144A under the Act, provided that the Company shall have been furnished with such information as the Company may reasonably request to provide a reasonable assurance that the provisions of Rule 144 or 144A have been satisfied. Each certificate representing this Warrant or the shares of Series Preferred thus transferred (except a transfer pursuant to Rule 144 or 144A) shall bear a legend as to the applicable restriction on transferability in order to ensure compliance with such laws, unless in the aforesaid opinion of counsel for the holder, such legend is not required in order to ensure compliance with such laws. The Company may issue stop transfer instructions to its transfer agent in connection with such restrictions.

(c) Applicability of Restrictions. Neither any restrictions of any legend described in this Warrant nor the requirements of Section 7(b) above shall apply to any transfer of, or grant of a security interest in, this Warrant (or the Series Preferred or Common Stock obtainable upon exercise thereof) or any part hereof (i) to a partner of the holder if the holder is a partnership or to a member of the holder if the holder is a limited liability company, (ii) to a partnership of which the holder is a partner or to a limited liability company of which the holder is a member, (iii) to any affiliate of the holder if the holder is a corporation, (iv) notwithstanding the foregoing, to any corporation, company, limited liability company, limited partnership, partnership, or other person managed or sponsored by Compass Horizon Funding Company LLC (“Finance LLC”) or its principals or in which Finance LLC has an interest, (v) to Horizon Credit I LLC or (vi) to a lender to the holder or any of the foregoing; provided, however, in any such transfer, if applicable, the transferee shall agree in writing to be bound by the terms of this Warrant as if an original holder hereof.

8. Rights as Shareholders; Information. No holder of this Warrant, as such, shall be entitled to vote or receive dividends or be deemed the holder of Series Preferred or any other securities of the Company which may at any time be issuable upon the exercise hereof for any purpose, nor shall anything contained herein be construed to confer upon the holder of this Warrant, as such, any of the rights of a shareholder of the Company or any right to vote for the election of directors or upon any matter submitted to shareholders at any meeting thereof, or to receive notice of meetings, or to receive dividends or subscription rights or otherwise until this Warrant shall have been exercised and the Shares purchasable upon the exercise hereof shall have become deliverable, as provided herein. Notwithstanding the foregoing, the Company will transmit to the holder of this Warrant such information, documents and reports as are generally distributed to the holders of any class or series of the securities of the Company concurrently with the distribution thereof to the shareholders.

9. Registration Rights. The Company hereby covenants to make a party to the Company's Amended and Restated Investor Rights Agreement to be executed subsequent to the Date of Grant (the "Registration Rights Agreement") to provide holder with registration rights as though the holder were a Holder (as defined therein), with the following exceptions and clarifications:

(1) The holder will not have the right to demand registration, but can otherwise participate in any registration demanded by others.

(2) The holder will be subject to the same provisions regarding indemnification as contained in the Registration Rights Agreement.

(3) The registration rights are freely assignable by the holder of this Warrant in connection with a permitted transfer of this Warrant or the Shares pursuant to Section 7(c) hereof.

10. Additional Rights.

10.1 Acquisition Transactions. The Company shall provide the holder of this Warrant with at least twenty (20) days written notice prior to closing thereof of the terms and conditions of any of the following transactions (to the extent the Company has notice thereof): (i) the sale, lease, exchange, conveyance or other disposition of all or substantially all of the Company's property or business, or (ii) its merger into or consolidation with any other corporation (other than a wholly-owned subsidiary of the Company), or any transaction (including a merger or other reorganization) or series of related transactions, in which more than 50% of the voting power of the Company is disposed of.

10.2 Right to Convert Warrant into Stock: Net Issuance.

(a) Right to Convert. In addition to and without limiting the rights of the holder under the terms of this Warrant, the holder shall have the right to convert this Warrant or any portion thereof (the "Conversion Right") into shares of Series Preferred as provided in this Section 10.2 at any time or from time to time during the term of this Warrant. Upon exercise of the Conversion

Right with respect to a particular number of shares subject to this Warrant (the “Converted Warrant Shares”), the Company shall deliver to the holder (without payment by the holder of any exercise price or any cash or other consideration) that number of shares of fully paid and nonassessable Series Preferred as is determined according to the following formula:

$$X = \frac{B - A}{Y}$$

Where: X = the number of shares of Series Preferred that shall be issued to holder

Y = the fair market value of one share of Series Preferred

A = the aggregate Warrant Price of the specified number of Converted Warrant Shares immediately prior to the exercise of the Conversion Right (*i.e.*, the number of Converted Warrant Shares *multiplied by* the Warrant Price)

B = the aggregate fair market value of the specified number of Converted Warrant Shares (*i.e.*, the number of Converted Warrant Shares *multiplied by* the fair-market value of one Converted Warrant Share)

No fractional shares shall be issuable upon exercise of the Conversion Right, and, if the number of shares to be issued determined in accordance with the foregoing formula is other than a whole number, the Company shall pay to the holder an amount in cash equal to the fair market value of the resulting fractional share on the Conversion Date (as hereinafter defined). For purposes of Section 10 of this Warrant, shares issued pursuant to the Conversion Right shall be treated as if they were issued upon the exercise of this Warrant.

(b) Method of Exercise. The Conversion Right may be exercised by the holder by the surrender of this Warrant at the principal office of the Company together with a written statement (which may be in the form of Exhibit A-1 or Exhibit A-2 hereto) specifying that the holder thereby intends to exercise the Conversion Right and indicating the number of shares subject to this Warrant which are being surrendered (referred to in Section 10.2(a) hereof as the Converted Warrant Shares) in exercise of the Conversion Right. Such conversion shall be effective upon receipt by the Company of this Warrant together with the aforesaid written statement, or on such later date as is specified therein (the “Conversion Date”), and, at the election of the holder hereof, may be made contingent upon the closing of the sale of the Company’s Common Stock to the public in a public offering pursuant to a Registration Statement under the Act (a “Public Offering”). Certificates for the shares issuable upon exercise of the Conversion Right and, if applicable, a new warrant evidencing the balance of the shares remaining subject to this Warrant, shall be issued as of the Conversion Date and shall be delivered to the holder within thirty (30) days following the Conversion Date.

(c) Determination of Fair Market Value. For purposes of this Section 10.2, “fair market value” of a share of Series Preferred (or Common Stock if the Series Preferred has been

automatically converted into Common Stock) as of a particular date (the “Determination Date”) shall mean:

(i) If the Conversion Right is exercised in connection with and contingent upon a Public Offering, and if the Company’s Registration Statement relating to such Public Offering (“Registration Statement”) has been declared effective by the Securities Exchange Commission, then the initial “Price to Public” specified in the final prospectus with respect to such offering.

(ii) If the Conversion Right is not exercised in connection with and contingent upon a Public Offering, then as follows:

(A) If traded on a securities exchange, the fair market value of the Common Stock shall be deemed to be the average of the closing prices of the Common Stock on such exchange over the five trading days immediately prior to the Determination Date, and the fair market value of the Series Preferred shall be deemed to be such fair market value of the Common Stock multiplied by the number of shares of Common Stock into which each share of Series Preferred is then convertible;

(B) If traded on the Nasdaq Stock Market or other over-the-counter system, the fair market value of the Common Stock shall be deemed to be the average of the closing prices of the Common Stock over the five trading days immediately prior to the Determination Date, and the fair market value of the Series Preferred shall be deemed to be such fair market value of the Common Stock multiplied by the number of shares of Common Stock into which each share of Series Preferred is then convertible; and

(C) If there is no public market for the Common Stock, then fair market value shall be determined by the Board of Directors of the Company in good faith.

In making a determination under clauses (A) or (B) above, if on the Determination Date, five trading days had not passed since the IPO, then the fair market value of the Common Stock shall be the average closing prices or closing bid prices, as applicable, for the shorter period beginning on and including the date of the IPO and ending on the trading day prior to the Determination Date (or if such period includes only one trading day, the closing price or closing bid price, as applicable, for such trading day). If closing prices or closing bid prices are no longer reported by a securities exchange or other trading system, the closing price or closing bid price shall be that which is reported by such securities exchange or other trading system at 4:00 p.m. New York City time on the applicable trading day.

10.3 Exercise Prior to Expiration. To the extent this Warrant is not previously exercised as to all of the Shares subject hereto, and if the fair market value of one share of the Series Preferred is greater than the Warrant Price then in effect, this Warrant shall be deemed automatically exercised pursuant to Section 10.2 above (even if not surrendered) immediately before its expiration. For purposes of such automatic exercise, the fair market value of one share of the Series Preferred upon such expiration shall be determined pursuant to Section 10.2(c). To the extent this Warrant or any portion thereof is deemed automatically exercised pursuant to this Section 10.3, the Company agrees

to promptly notify the holder hereof of the number of Shares, if any, the holder hereof is to receive by reason of such automatic exercise.

11. Representations and Warranties. The Company represents and warrants to the holder of this Warrant as follows:

(a) This Warrant has been duly authorized and executed by the Company and is a valid and binding obligation of the Company enforceable in accordance with its terms, subject to laws of general application relating to bankruptcy, insolvency and the relief of debtors and the rules of law or principles at equity governing specific performance, injunctive relief and other equitable remedies.

(b) The Shares have been duly authorized and reserved for issuance by the Company and, when issued in accordance with the terms hereof, will be validly issued, fully paid and nonassessable and free from preemptive rights.

(c) The rights, preferences, privileges and restrictions granted to or imposed upon the Series Preferred and the holders thereof will be as set forth in the Charter.

(d) The shares of Common Stock issuable upon conversion of the Shares have been duly authorized and reserved for issuance by the Company and, when issued in accordance with the terms of the Charter will be validly issued fully paid and nonassessable.

(e) The execution and delivery of this Warrant are not, and the issuance of the Shares upon exercise of this Warrant in accordance with the terms hereof will not be, inconsistent with the Company's Charter or by law do not and will not contravene any law, governmental rule or regulation, judgment or order applicable to the Company, and do not and will not conflict with or contravene any provision of, or constitute a default under, any indenture, mortgage, contract or other instrument of which the Company is a party or by which it is bound or require the consent or approval of, the giving of notice to, the registration or filing with or the taking of any action in respect of or by, any Federal, state or local government authority or agency or other person, except for the filing of notices, pursuant to federal and state securities laws, which filings will be effected by the time required thereby.

(f) There are no actions, suits, audits, investigations or proceedings pending or, to the knowledge of the Company, threatened against the Company in any court or before any governmental commission, board or authority which, if adversely determined, could have a material adverse effect on the ability of the Company to perform its obligations under this Warrant.

(g) The number of shares of Common Stock of the Company outstanding on the date hereof, on a fully diluted basis (assuming the conversion of all outstanding convertible securities and the exercise of all outstanding options and warrants), does not exceed 260,000,000 shares.

12. Modification and Waiver. This Warrant and any provision hereof may be changed, waived, discharged or terminated only by an instrument in writing signed by the party against which enforcement of the same is sought.

13. Notices. Any notice, request, communication or other document required or permitted to be given or delivered to the holder hereof or the Company shall be delivered, or shall be sent by certified or registered mail, postage prepaid, to each such holder at its address as shown on the books of the Company or to the Company at the address indicated therefor on the signature page of this Warrant.

14. Binding Effect on Successors. This Warrant shall be binding upon any corporation succeeding the Company by merger, consolidation or acquisition of all or substantially all of the Company's assets, and all of the obligations of the Company relating to the Series Preferred issuable upon the exercise or conversion of this Warrant shall survive the exercise, conversion and termination of this Warrant and all of the covenants and agreements of the Company shall inure to the benefit of the successors and assigns of the holder hereof.

15. Lost Warrants or Stock Certificates. The Company covenants to the holder hereof that, upon receipt of evidence reasonably satisfactory to the Company of the loss, theft, destruction or mutilation of this Warrant or any stock certificate and, in the case of any such loss, theft or destruction, upon receipt of an indemnity reasonably satisfactory to the Company, or in the case of any such mutilation upon surrender and cancellation of such Warrant or stock certificate, the Company will make and deliver a new Warrant or stock certificate, of like tenor, in lieu of the lost, stolen, destroyed or mutilated Warrant or stock certificate.

16. Descriptive Headings. The descriptive headings of the various Sections of this Warrant are inserted for convenience only and do not constitute a part of this Warrant. The language in this Warrant shall be construed as to its fair meaning without regard to which party drafted this Warrant.

17. Governing Law. This Warrant shall be construed and enforced in accordance with, and the rights of the parties shall be governed by, the laws of the State of Delaware.

18. Survival of Representations, Warranties and Agreements. All representations and warranties of the Company and holder hereof contained herein shall survive the Date of Grant, the exercise or conversion of this Warrant (or any part hereof) or the termination or expiration of rights hereunder. All agreements of the Company and the holder, hereof contained herein shall survive indefinitely until, by their respective terms, they are no longer operative.

19. Remedies. In case any one or more of the covenants and agreements contained in this Warrant shall have been breached the holders hereof (in the case of a breach by the Company), or the Company (in the case of a breach by a holder), may proceed to protect and enforce their or its rights either by suit in equity and/or by action at law, including, but not limited to, an action for damages as a result of any such breach and/or an action for specific performance of any such covenant or agreement contained in this Warrant.

20. No Impairment of Rights. The Company will not, by amendment of its Charter or through any other means, avoid or seek to avoid the observance or performance of any of the terms of this Warrant, but will at all times in good faith assist in the carrying out of all such terms and in

the taking of all such action as may be necessary or appropriate in order to protect the rights of the holder of this Warrant against impairment.

21. Severability. The invalidity or unenforceability of any provision of this Warrant in any jurisdiction shall not affect the validity or enforceability of such provision in any other jurisdiction, or affect any other provision of this Warrant, which shall remain in full force and effect.

22. Recovery of Litigation Costs. If any legal action or other proceeding is brought for the enforcement of this Warrant, or because of an alleged dispute, breach, default, or misrepresentation in connection with any of the provisions of this warrant, the successful or prevailing party or parties shall be entitled to recover reasonable attorney's fees and other costs incurred in that action or proceeding, in addition to any other relief to which it or they may be entitled.

23. Entire Agreement; Modification. This warrant constitutes the entire agreement between the parties pertaining to the subject matter contained in it and supersedes all prior and contemporaneous agreements, representations, and undertakings of the parties, whether oral or written, with respect to such subject matter.

The Company has caused this Warrant to be duly executed and delivered as of the Date of Grant specified above.

ENPHASE ENERGY, INC.

By: /s/ Paul Nahi

Name: Paul Nahi

Title: PRES & CEO

Address: 201 1st Street, Suite 300
Petaluma, CA 94952

EXHIBIT A-1

NOTICE OF EXERCISE

To: ENPHASE ENERGY, INC. (the "Company")

1. The undersigned hereby:

- elects to purchase _____ shares of [Series Preferred Stock] [Common Stock] of the Company pursuant to the terms of the attached Warrant, and tenders herewith payment of the purchase price of such shares in full, or
- elects to exercise its net issuance rights pursuant to Section 10.2 of the attached Warrant with respect to _____ Shares of [Series Preferred Stock] [Common Stock].

2. Please issue a certificate or certificates representing _____ shares in the name of the undersigned or in such other name or names as are specified below.

(Name)

(Address)

3. The undersigned represents that the aforesaid shares are being acquired for the account of the undersigned for investment and not with a view to, or for resale in connection with, the distribution thereof and that the undersigned has no present intention of distributing or reselling such shares all except as in compliance with applicable securities laws.

(Signature)

(Date)

NOTICE OF EXERCISE

To: ENPHASE ENERGY, INC. (the "Company")

1. Contingent upon and effective immediately prior to the closing (the "Closing") of the Company's public offering contemplated by the Registration Statement on Form S____, filed _____, 200__, the undersigned hereby:

- elect to purchase _____ shares of [Series Preferred Stock] [Common Stock] of the Company (or such lesser number of shares as may be sold on behalf of the undersigned at the Closing) pursuant to the terms of the attached Warrant, or
- elects to exercise its net issuance rights pursuant to Section 10.2 of the attached Warrant with respect to _____ Shares of [Series Preferred Stock] [Common Stock].

2. Please deliver to the custodian for the selling shareholders a stock certificate representing such _____ shares.

3. The undersigned has instructed the custodian for the selling shareholders to deliver to the Company \$_____ or, if less, the net proceeds due the undersigned from the sale of shares in the aforesaid public offering. If such net proceeds are less than the purchase price for such shares, the undersigned agrees to deliver the difference to the Company prior to the Closing.

(Signature)

(Date)

THIS WARRANT HAS NOT BEEN REGISTERED UNDER THE SECURITIES ACT OF 1933, AS AMENDED OR ANY STATE SECURITIES LAWS. NO SALE OR DISPOSITION MAY BE EFFECTED WITHOUT (i) EFFECTIVE REGISTRATION STATEMENTS RELATED THERETO, (ii) AN OPINION OF COUNSEL OR OTHER EVIDENCE, REASONABLY SATISFACTORY TO THE COMPANY, THAT SUCH REGISTRATIONS ARE NOT REQUIRED, (iii) RECEIPT OF NO-ACTION LETTERS FROM THE APPROPRIATE GOVERNMENTAL AUTHORITIES, OR (iv) OTHERWISE COMPLYING WITH THE PROVISIONS OF SECTION 7 OF THIS WARRANT.

ENPHASE ENERGY, INC.

WARRANT TO PURCHASE OF SHARES
OF SERIES PREFERRED STOCK

THIS CERTIFIES THAT, for value received, HORIZON TECHNOLOGY FINANCE CORPORATION and its assignees are entitled to subscribe for and purchase that number of the fully paid and nonassessable shares of Series Preferred stock (as adjusted pursuant to Section 4 hereof, the "Shares") of ENPHASE ENERGY, INC., a Delaware corporation (the "Company"), as is determined pursuant to the next paragraph hereof at the price per share as is determined pursuant to the next paragraph hereof (such price and such other price as shall result, from time to time, from the adjustments specified in Section 4 hereof is herein referred to as the "Warrant price"), subject to the provisions and upon the terms and conditions hereinafter set forth. As used therein, (a) the term "Series Preferred" shall mean either (i) the Company's Series E Preferred Stock and any stock into or for which such Series E Preferred Stock may hereafter be converted or exchanged, and after the automatic conversion of the Series E Preferred Stock to Common Stock, shall mean the Company's Common Stock or (ii) if the Company completes a Qualified Financing (as defined below) within ninety (90) days after the Date of Grant, the series of convertible preferred stock sold by the Company in such offering (the "Next Round Preferred Stock"), and after the automatic conversion of the Next Round Preferred stock to Common Stock, shall mean the Company's Common Stock, as applicable, and (b) the term "Date of Grant" shall mean March 25, 2011. The term "Warrant" as used herein shall be deemed to include any warrant issued upon transfer or partial exercise of or in lieu of this Warrant, unless the context clearly requires otherwise.

The Warrant price shall be (i) \$0.68 per share for each share of the Company's Series E Preferred stock, or the Common Stock into which such Series E Preferred Stock is converted, which is purchased hereunder, or (ii) the lowest effective price per share (on a common stock equivalent basis and taking into account any securities issued together with the Next Round Preferred Stock) at which shares of the Next Round Preferred Stock are sold in a Qualified Financing, for each share of Next Round Preferred Stock which is purchased hereunder. A "Qualified Financing" shall mean the sale of the convertible preferred stock of the Company to purchase which include venture capital investors in an aggregate cash amount not less than \$15,000,000. The number of Shares for which this Warrant is exercisable shall be determined as follows:

a) In the event the Company does not complete a Qualified Financing within ninety (90) days after the Date of Grant, the holder shall be entitled to purchase Four Hundred Forty One Thousand One Hundred Seventy Seven (441,177) shares of the Company's Series E Preferred Stock;

b) If the Company completes a Qualified Financing within fourteen (14) days after the Date of Grant, the holder shall be entitled to purchase the nearest whole number of shares of Next Round Preferred Stock determined by dividing Three Hundred Thousand and 00/100 Dollars (\$300,000) by the lowest effective price per share (on a common stock equivalent basis and taking into account any securities issued together with the Next Round Preferred Stock) at which shares of the Next Round Preferred Stock are sold in such Qualified Financing; or

c) If the Company completes a Qualified Financing more than fourteen (14) days after the Date of Grant, but on or prior to ninety (90) days after the Date of Grant, the holder shall be entitled to purchase Two Hundred Twenty Thousand Five Hundred Eighty-Eight (220,588) shares of Series E Preferred Stock plus the nearest whole number of shares of Next Round Preferred Stock determined by dividing One Hundred Fifty Thousand Dollars (\$150,000) by lowest effective price per share (on a common stock equivalent basis and taking into account any securities issued together with the Next Round Preferred Stock) at which shares of the Next Round Preferred stock are sold in such Qualified Financing.

1. Term. The purchase right represented by this Warrant is exercisable, in whole or in part, at any time and from time to time from the Date of Grant through the later of (i) ten (10) years after the Date of Grant or (ii) five (5) years after the closing of the Company's initial public offering of its Common Stock ("IPO") effected pursuant to a Registration Statement on Form S-1 (or its successor) filed under the Securities Act of 1933, as amended (the "Act").

2. Method of Exercise: Payment: Issuance of New Warrant. Subject to Section 1 hereof, the purchase right represented by this Warrant may be exercised by the holder hereof, in whole or in part and from time to time at the election of the holder hereof, by (a) the surrender of this Warrant (with the notice of exercise substantially in the form attached hereto as Exhibit A-1 duly completed and executed) at the principal office of the Company and by the payment to the Company, by certified or bank check, or by wire transfer to an account designated by the Company (a "Wire Transfer") of an amount equal to the then applicable Warrant Price multiplied by the number of Shares then being purchased; (b) if in connection with a registered public offering of the Company's securities the surrender of this Warrant (with the notice of exercise form attached hereto as Exhibit A-2 duly completed and executed) at the principal office of the Company together with notice of arrangements reasonably satisfactory to the Company for payment to the Company either by certified or bank check or by Wire Transfer from the proceeds of the sale of shares to be sold by the holder in such public offering of an amount equal to the then applicable Warrant Price per share multiplied by the number of Shares then being purchased; or (c) exercise of the "net issuance" right provided for in Section 10.2 hereof. The person or persons in whose name(s) any certificate(s) representing shares of Series Preferred shall be issuable upon exercise of this Warrant shall be deemed to have become the holder(s) of record of, and shall be treated for all purposes as the record

holder(s) of, the shares represented thereby (and such shares shall be deemed to have been issued) immediately prior to the close of business on the date or dates upon which this Warrant is exercised. In the event of any exercise of the rights represented by this Warrant, certificates for the shares of stock so purchased shall be delivered to the holder hereof as soon as possible and in any event within thirty (30) days after such exercise and, unless this Warrant has been fully exercised or expired, a new Warrant representing the portion of the Shares, if any, with respect to which this Warrant shall not then have been exercised shall also be issued to the holder hereof as soon as possible and in any event within such thirty-day period; provided, however, at such time as the Company is subject to the reporting requirements of the Securities Exchange Act of 1934, as amended, if requested by the holder of this Warrant, the Company shall cause its transfer agent to deliver the certificate representing Shares issued upon exercise of this Warrant to a broker or other person (as directed by the holder exercising this Warrant) within the time period required to settle any trade made by the holder after exercise of this Warrant.

3. Stock Fully Paid: Reservation of Shares. All Shares that may be issued upon the exercise of the rights represented by this Warrant will, upon Issuance pursuant to the terms and conditions herein, be fully paid and nonassessable, and free from preemptive rights and taxes, liens and charges with respect to the issue thereof. During the period within which the rights represented by this Warrant may be exercised, the Company will at all times have authorized, and reserved for the purpose of the issue upon exercise of the purchase rights evidenced by this Warrant, a sufficient number of shares of its Series Preferred to provide for the exercise of the rights represented by this Warrant and a sufficient number of shares of its Common Stock to provide for the conversion of the Series Preferred into Common stock.

4. Adjustment of Warrant Price and Number of Shares. The number and kind of securities purchasable upon the exercise of this Warrant and the Warrant Price shall be subject to adjustment from time to time upon the occurrence events, as follows:

(a) Reclassification or Merger. In case of any reclassification or change of securities of the class issuable upon exercises of this Warrant (other than a change in par value, or from par value to no par value, or from no par value to par value, or as a result of a subdivision or combination), or in case of any merger of the Company with or into another corporation (other than a merger with another corporation in which the Company is the acquiring and the surviving corporation and which does result in any reclassification or change of outstanding securities issuable upon exercise of this Warrant), or in case of any sale of all or substantially all of the assets of the Company, the Company, or such successor or purchasing corporation, as the case may be, shall duly execute and deliver to the holder of this Warrant a new Warrant (in form and substance satisfactory to the holder of this Warrant), so that the holder of this Warrant shall have the right to receive upon exercise of this Warrant, at a total purchase price not to exceed that payable upon the exercise of the unexercised portion of this Warrant, and in lieu of the shares of Series Preferred therefore issuable upon exercise of this Warrant, (i) the kind and amount of shares of stock, other securities, money and property receivable upon such reclassification, change, merger or sale by a holder of the number of shares of Series Preferred then purchasable under this Warrant, or (ii) in the case of such a merger or sale in which the consideration paid consists all or in part of assets other than securities of the successor or purchasing corporation, at the option of the holder of this Warrant,

the securities of the successor or purchasing corporation having a value at the time of the transaction equivalent to the value of the Series Preferred purchasable upon exercise of this Warrant at the time of the transaction. Any new Warrant shall provide for adjustments that shall be as nearly equivalent as may be practicable to the adjustments provided for in this Section 4. The Provisions of this Section 4(a) shall similarly apply to successive reclassifications, changes, mergers and sales.

(b) Subdivision or Combination of Shares. If the Company at any time while this Warrant remains outstanding and unexpired shall subdivide or combine its outstanding shares of Series Preferred, the Warrant Price shall be proportionately decreased and the number of Shares issuable hereunder shall be proportionately increased in the case of a subdivision and the Warrant Price shall be proportionately increased and the number of Shares issuable hereunder shall be proportionately decreased in the case of a combination.

(c) Stock Dividends and Other Distributions. If the Company at any time while this Warrant is outstanding and unexpired shall (i) pay a dividend with respect to Series Preferred payable in Series Preferred, then the Warrant Price shall be adjust, from and after the date of determination of shareholders entitled to receive such dividend or distribution, to that price determined by multiplying the Warrant Price in effect immediately prior to such date of determination by a fraction (A) the numerator of which shall be the total number of shares of Series Preferred outstanding immediately prior to such dividend or distribution, and (B) the denominator of which shall be the total number of shares of Series Preferred outstanding immediately after such dividend or distribution; or (ii) make any other distribution with respect to Series Preferred (except any distribution specifically provided for in Section 4(a) and 4(b)), then, in each such case, provision shall be made by the Company such that the holder of this Warrant shall receive upon exercise of this Warrant a proportionate share of any such dividend or distribution as though it were the holder of the Series Preferred (or Common Stock issuable upon conversion thereof) as of the record date fixed for the determination of the shareholders of the Company entitled to receive such dividend or distribution.

(d) Adjustment of Number of Shares. Upon each adjustment in the Warrant Price, the number of Shares of Series Preferred purchasable hereunder shall be adjusted, to the nearest whole share, to the product obtained by multiplying the number of Shares purchasable immediately prior to such adjustment in the Warrant Price by a fraction, the numerator of which shall be the Warrant Price immediately prior to such adjustment and the denominator of which shall be the Warrant Price immediately thereafter.

(e) Antidilution Rights. The other antidilution rights applicable to the Shares of Series Preferred purchasable hereunder are set forth in the Company's Certificate of Incorporation, as amended from time to time (the "Charter"). Such antidilution rights shall not be restated, amended, modified or waived in any manner that treats the holder hereof adversely to other holders of the class and series of the Company's capital stock for which this Warrant is exercisable without such holder's prior written consent. The Company shall promptly provide the holder hereof with any restatement, amendment, modification or waiver of the Charter promptly after the same has been made.

5. Notice of Adjustments. Whenever the Warrant Price or the number of Shares purchasable hereunder shall be adjusted pursuant to Section 4 hereof, the Company shall make a certificate signed by its chief financial officer setting forth, in reasonable detail, the event requiring the adjustment, the amount of the adjustment, the method by which such adjustment was calculated, and the Warrant Price and the number of Shares purchasable hereunder after giving effect to such adjustment, and shall cause copies of such certificate to be mailed (without regard to Section 13 hereof, by first class mail, postage prepaid) to the holder of this Warrant. In addition, whenever the conversion price or conversion ratio of the Series Preferred shall be adjusted, the Company shall make a certificate signed by its chief financial officer setting forth, in reasonable detail the event requiring the adjustment, the amount of the adjustment, the method by which such adjustment was calculated, and the conversion price or ratio of the Series Preferred after giving effect to such adjustment, and shall cause copies of such certificate to be mailed (without regard to Section 13 hereof, by first class mail, postage prepaid) to the holder of this Warrant.

6. Fractional Shares. No fractional shares of Series Preferred will be issued in connection with any exercise hereunder, but in lieu of such fractional shares the Company shall make a cash payment therefor based on the fair market value of the Series Preferred on the date of exercise as reasonably determined in good faith by the Company's Board of Directors.

7. Compliance with Act; Disposition of Warrant or Shares of Series Preferred.

(a) Compliance with Act. The holder of this Warrant, by acceptance hereof, agrees that this Warrant, and the shares of Series Preferred to be issued upon exercise hereof and any common Stock issued upon conversion thereof are being acquired for investment and that such holder will not offer, sell or otherwise dispose of this Warrant, or any shares of Series Preferred to be issued upon exercise hereof or any Common Stock issued upon conversion thereof except under circumstances which will not result in a violation of the Act or any applicable state securities laws. Upon exercise of this Warrant, unless the Shares being acquired are registered under the Act and any applicable state securities laws or an exemption from such registration is available, the holder hereof shall confirm in writing that the shares of Series Preferred so purchased (and any shares of Common Stock issued upon conversion thereof) are being acquired for investment and not with a view toward distribution or resale in violation of the Act and shall confirm such other matters related thereto as may be reasonably requested by the Company. This Warrant and all shares of Series Preferred issued upon exercise of this Warrant and all shares of Common Stock issued upon conversion thereof (unless registered under the Act and any applicable state securities laws) shall be stamped or imprinted with a legend in substantially the following form:

“THE SECURITIES EVIDENCED HEREBY HAVE NOT BEEN REGISTERED UNDER THE SECURITIES ACT OF 1933, AS AMENDED, OR ANY STATE SECURITIES LAWS. NO SALE OR DISPOSITION MAY BE EFFECTED WITHOUT (i) EFFECTIVE REGISTRATION STATEMENTS RELATED THERETO, (ii) AN OPINION OF COUNSEL OR OTHER EVIDENCE, REASONABLY SATISFACTORY TO THE COMPANY, THAT SUCH REGISTRATIONS ARE NOT REQUIRED, (iii) RECEIPT OF NO-ACTION LETTERS FROM THE APPROPRIATE GOVERNMENTAL AUTHORITIES, OR (iv) OTHERWISE COMPLYING

Said legend shall be removed by the Company, upon the request of a holder, at such time as the restrictions on the transfer of the applicable security shall have terminated. In addition, in connection with the issuance of this Warrant, the holder specifically represents to the Company by acceptance of this Warrant as follows:

(1) The holder is aware of the Company’s business affairs and financial condition, and has acquired information about the Company sufficient to reach an informed and knowledgeable decision to acquire this Warrant. The holder is acquiring this Warrant for its own account for investment purposes only and not with a view to, or for the resale in connection with, any “distribution” thereof in violation of the Act.

(2) The holder understands that this Warrant has not been registered under the Act in reliance upon a specific exemption therefrom, which exemption depends upon, among other things, the bona fide nature of the holder’s investment intent as expressed herein.

(3) The holder further understands that this Warrant must be held indefinitely unless subsequently registered under the Act and qualified under any applicable state securities laws, or unless exemptions from registration and qualification are otherwise available. The holder is aware of the provisions of Rule 144, promulgated under the Act.

(4) The holder is an “accredited investor” as such term is defined in Rule 501 of Regulation D promulgated under the Act.

(b) Disposition of Warrant or Shares. With respect to any offer, sale or other disposition of this Warrant or any shares of Series Preferred acquired pursuant to the exercise of this Warrant prior to registration of such Warrant or shares, the holder hereof agrees to give written notice to the Company prior thereto, describing briefly the manner thereof, together with a written opinion of such holder’s counsel, or other evidence, if reasonably satisfactory to the Company, to the effect that such offer, sale or other disposition may be effected without registration or qualification (under the Act as then in effect or any federal or state securities law then in effect) of this Warrant or such shares of Series Preferred or Common Stock and indicating whether or not under the Act certificates for this Warrant or such shares of Series Preferred to be sold or otherwise disposed of require any restrictive legend as to applicable restrictions on transferability in order to ensure compliance with such law. Upon receiving such written notice and reasonably satisfactory opinion or other evidence, the Company, as promptly as practicable but no later than fifteen (15) days after receipt of the written notice, shall notify such holder that such holder may sell or otherwise dispose of this Warrant of such shares of Series Preferred or Common Stock, all in accordance with the terms of the notice delivered to the Company. If a determination has been made pursuant to this Section 7(b) that the opinion of counsel for the holder or other evidence is not reasonably satisfactory to the Company, the Company shall so notify the holder promptly with details thereof after such determination has been made. Notwithstanding the foregoing, this Warrant or such shares of Series Preferred or Common Stock may, as to such federal laws, be offered, sold or otherwise disposed of

in accordance with Rule 144 or 144A under the Act, provided that the Company shall have been furnished with such information as the Company may reasonably request to provide a reasonable assurance that the provisions of Rule 144 or 144A have been satisfied. Each certificate representing this Warrant or the shares of Series Preferred thus transferred (except a transfer pursuant to Rule 144 or 144A) shall bear a legend as to the applicable restrictions on transferability in order to ensure compliance with such laws, unless in the aforesaid opinion of counsel for the holder such legend is not required in order to ensure compliance with such laws. The Company may issue stop transfer instructions to its transfer agent in connection with such restrictions.

(c) Applicability of Restrictions. Neither any restrictions of any legend described in this Warrant nor the requirements of Section 7(b) above shall apply in any transfer of, or grant of a security interest in, this Warrant (or the Series Preferred or Common Stock obtainable upon exercise thereof) or any part hereof (i) to a partner of the holder if the holder is a partnership or to a member of the holder if the holder is a limited liability company, (ii) to a partnership of which the holder is a partner or to a limited liability company of which the holder is a member, (iii) to any affiliate of the holder if the holder is a corporation, (iv) notwithstanding the foregoing, to any corporation, company, limited liability company, limited partnership, partnership, or other person owned, managed or sponsored by Horizon Technology Finance Corporation (“HRZN”) or its principals or in which HRZN has an interest, (v) to Horizon Credit ILLC or (vi) to a lender to the holder or any of the foregoing; provided, however, in any such transfer if applicable, the transferee shall agree in writing to be bound by the terms of this Warrant as if an original holder hereof.

8. Rights as Shareholders; Information. No holder of this Warrant, as such, shall be entitled to vote or receive dividends or be deemed the holder of Series Preferred or any other securities of the Company which may at any time be issuable upon the exercise hereof for any purpose, nor shall anything contained herein be construed to confer upon the holder of this Warrant, as such, any of the rights of a shareholder of the company or any right to vote for the election of directors or upon any matter submitted to shareholders at any meeting thereof, or to receive notice of meetings, or to receive dividends rights or subscription or otherwise until this Warrant shall have been exercised and the Shares purchasable upon the exercise hereof shall have become deliverable, as provided herein. Notwithstanding the foregoing, the Company will transmit to the holder of this Warrant such information, documents and reports as are generally distributed to the holders of any class or series of the securities of the Company concurrently with the distribution thereof to the shareholders.

9. Registration Rights. The Company hereby covenants to make holder a party to the Company’s Amended and Restated Investor Rights Agreement to be executed subsequent to the Date of Grant (the “Registration Rights Agreement”) to provide holder with registration rights as though the holder were a Holder (as defined therein), with the following exceptions and clarifications:

- (1) The holder will not have the right to demand registration, but can otherwise participate in any registration demanded by others.
- (2) The holder will be subject to the same provisions regarding indemnification as contained in the Registration Rights Agreement.

(3) The registration rights are freely assignable by the holder of this Warrant in connection with a permitted transfer of this Warrant or the Shares pursuant to Section 7(c) hereof.

10. Additional Rights.

10.1 Acquisition Transactions. The Company shall provide the holder of this Warrant with at least twenty (20) days' written notice prior to closing thereof of the terms and conditions of any of the following transactions (to the extent the Company has notice thereof): (i) the sale, lease, exchange, conveyance or other disposition of all or substantially all of the Company's property or business, or (ii) its merger into or consolidation with any other corporation (other than a wholly-owned subsidiary of the Company), or any transaction (including a merger or other reorganization) or series of related transactions, in which more than 50% of the voting power of the Company is disposed of.

10.2 Right to Convert Warrant into Stock: Net Issuance.

(a) Right to Convert. In addition to and without limiting the rights of the holder under the terms of this Warrant, the holder shall have the right to convert this Warrant or any portion thereof (the "Conversion Right") into shares of Series Preferred as provided in this Section 10.2 at any time or from time to time during the term of this Warrant. Upon exercise of the Conversion Right with respect to a particular number of shares subject to this Warrant (the "Converted Warrant Shares"), the Company shall deliver to the holder (without payment by the holder of any exercise price or any cash or other consideration) that number of shares of fully paid and nonassessable Series Preferred as is determined according to the following formula:

$$X = \frac{B - A}{Y}$$

Where: X = the number of shares of Series Preferred that shall be issued to holder

Y = the fair market value of one share of Series Preferred

A = the aggregate Warrant Price of the specified number of Converted Warrant Shares immediately prior to the exercise of the Conversion Right (*i.e.*, the number of Converted Warrant Shares *multiplied by* the Warrant Price)

B = the aggregate fair market value of the specified number of Converted Warrant Shares (*i.e.*, the number of Converted Warrant Shares *multiplied by* the fair market value of one Converted Warrant Share)

No fractional shares shall be issuable upon exercise of the Conversion Right, and, if the number of shares to be issued determined in accordance with the foregoing formula is other than a whole number, the Company shall pay to the holder an amount in cash equal to the fair market value of the resulting fractional share on the Conversion Date (as hereinafter defined). For purposes of

Section 10 of this Warrant, shares issued pursuant to the Conversion Right shall be treated as if they were issued upon the exercise of this Warrant.

(b) Method of Exercise. The Conversion Right may be exercised by the holder by the surrender of this Warrant at the principal office of the Company together with a written statement (which may be in the form of Exhibit A-1 or Exhibit A-2 hereto) specifying that the holder thereby intends to exercise the Conversion Right and indicating the number of shares subject to this Warrant which are being surrendered (referred to in Section 10.2(a) hereof as the Converted Warrant shares) in exercise of the Conversion Right. Such conversion shall be effective upon receipt by the Company of this Warrant together with the aforesaid written statement, or on such later date as is specified therein (the "Conversion Date"), and, at the election of the holder hereof, may be made contingent upon the closing of the sale of the Company's Common Stock to the public in a public offering pursuant to a Registration Statement under the Act (a "Public offering"). Certificates for the shares issuable upon exercise of the Conversion Right and, if applicable, a new warrant evidencing the balance of the shares remaining subject to this Warrant, shall be issued as of the Conversion Date and shall be delivered to the holder within thirty (30) days following the Conversion Date.

(c) Determination of Fair Market value. For purposes of this Section 10.2, "fair market value" of a share of Series Preferred (or common Stock if the Series Preferred has been automatically converted into Common Stock) as of a particular date (the "Determination Date") shall mean:

(i) If the Conversion Right is exercised in connection with and contingent upon a Public Offering, and if the Company's Registration Statement relating to such Public Offering ("Registration statement") has been declared effective by the Securities and Exchange Commission, then the initial "Price to Public" specified in the final prospectus with respect to such offering.

(ii) If the Conversion Right is not exercised in connection with and contingent upon a Public Offering, then as follows:

(A) If traded on a securities exchange, the fair market value of the Common Stock shall be deemed to be the average of the closing prices of the Common Stock on such exchange over the five trading days immediately prior to the Determination Date, and the fair market value of the Series Preferred shall be deemed to be such fair market value of the Common Stock multiplied by the number of shares of Common Stock into which each share of Series Preferred is then convertible;

(B) If traded on the Nasdaq Stock Market or other over-the-counter system, the fair market value of the Common Stock shall be deemed to be the average of the closing prices of the Common Stock over the five trading days immediately prior to the Determination Date, and the fair market value of the Series Preferred shall be deemed to be such fair market value of the Common Stock multiplied by the number of shares of Common Stock into which each share of Series Preferred is then convertible; and

(C) If there is no public market for the Common Stock, then fair market value shall be determined by the Board of Directors of the Company in good faith.

In making a determination under clauses (A) or (B) above, if on the Determination Date, five trading days had not passed since the IPO, then the fair market value of the Common Stock shall be the average closing prices or closing bid prices, as applicable, for the shorter period beginning on and including the date of the IPO and ending on the trading day prior to the Determination Date (or if such period includes only one trading day, the closing price or closing bid price, as applicable, for such trading day). If closing prices or closing bid prices are no longer, reported by a securities exchange or other trading system, the closing price or closing bid price shall be that which is reported by such securities exchange or other trading system at 4:00 p.m. New York City time on the applicable trading day.

10.3 Exercise Prior to Expiration. To the extent this Warrant is not previously exercised as to all of the Shares subject hereto, and if the fair market value of one share of the Series Preferred is greater than the Warrant Price then in effect, this Warrant shall be deemed automatically exercised pursuant to Section 10.2 above (even if not surrendered) immediately before its expiration. For purposes of such automatic exercise, the fair market value of one share of the Series Preferred upon such expiration shall be determined pursuant to Section 10.2(c). To the extent this Warrant or any portion thereof is deemed automatically exercised pursuant to this Section 10.3, the Company agrees to promptly notify the holder hereof of the number of Shares, if any, the holder hereof is to receive by reason of such automatic exercise.

11. Representations and Warranties. The Company represents and warrants to the holder of this Warrant as follows:

(a) This Warrant has been duly authorized and executed by the Company and is a valid and binding obligation of the Company enforceable in accordance with its terms, subject to laws of general application relating to bankruptcy, insolvency and the relief of debtors and the rules of law or principles at equity governing specific performance, injunctive relief and other equitable remedies.

(b) The Shares have been duly authorized and reserved for issuance by the Company and, when issued in accordance with the terms hereof, will be validly issued, fully paid and nonassessable and free from preemptive rights.

(c) The rights, preferences, privileges and restrictions granted to or imposed upon the Series Preferred and the holders thereof will be as set forth in the Charter.

(d) The shares of Common Stock issuable upon conversion of the Shares have been duly authorized and reserved for issuance by the Company and, when issued in accordance with the terms of the Charter will be validly issued, fully paid and nonassessable.

(e) The execution and delivery of this Warrant are not, and the issuance of the Shares upon exercise of this Warrant in accordance with the terms hereof will not be, inconsistent

with the Company's Charter or by-laws, do not and will not contravene any law, governmental rule or regulation, judgment or order applicable to the Company, and do not and will not conflict with or contravene any provision of, or constitute a default under, any indenture, mortgage, contract or other instrument of which the Company is a party or by which it is bound or require the consent or approval of, the giving of notice to, the registration or filing with or the taking of any action in respect of or by, any Federal, state or local government authority or agency or other person, except for the filing of notices pursuant to federal and state securities laws, which filings will be effected by the time required thereby.

(f) There are no actions, suits, audits, investigations or proceedings pending or, to the knowledge of the Company, threatened against the Company in any court or before any governmental commission, board or authority which, if adversely determined, could have a material adverse effect on the ability of the Company to perform its obligations under this Warrant.

(g) The number of shares of Common Stock of the Company outstanding on the date hereof, on a fully diluted basis (assuming the conversion of all outstanding convertible securities and the exercise of all outstanding options and warrants), does not exceed 310,000,000 shares.

12. Modification and Waiver. This Warrant and any provision hereof may be changed, waived, discharged or terminated only by an instrument in writing signed by the party against which enforcement of the same is sought.

13. Notices. Any notice, request, communication or other document required or permitted to be given or delivered to the holder hereof or the Company shall be delivered, or shall be sent by certified or registered mail, postage prepaid, to each such holder at its address as shown on the books of the Company or to the Company at the address indicated therefor on the signature page of this Warrant.

14. Binding Effect on Successors. This Warrant shall be binding upon any corporation succeeding the Company by merger, consolidation or acquisition of all or substantially all of the Company's assets, and all of the obligations of the Company relating to the Series Preferred issuable upon the exercise or conversion of this Warrant shall survive the exercise, conversion and termination of this Warrant and all of the covenants and agreements of the Company shall inure to the benefit of the successors and assigns of the holder hereof.

15. Lost Warrants or Stock Certificates. The Company covenants to the holder hereof that, upon receipt of evidence reasonably satisfactory to the Company of the loss, theft, destruction or mutilation of this Warrant or any stock certificate and, in the case of any such loss, theft or destruction, upon receipt of an indemnity reasonably satisfactory to the Company, or in the case of any such mutilation upon surrender and cancellation of such Warrant or stock certificate, the Company will make and deliver a new Warrant or stock certificate, of like tenor, in lieu of the lost, stolen, destroyed or mutilated Warrant or stock certificate.

16. Descriptive Headings. The descriptive headings of the various Sections of this Warrant are inserted for convenience only and do not constitute a part of this Warrant. The language

in this Warrant shall be construed as to its fair meaning without regard to which party drafted this Warrant.

17. Governing Law. This Warrant shall be construed and enforced in accordance with, and the rights of the parties shall be governed by, the laws of the State of Delaware.

18. Survival of Representations, Warranties and Agreements. All representations and warranties of the Company and the holder hereof contained herein shall survive the Date of Grants the exercise or conversion of this Warrant (or any part hereof) or the termination or expiration of rights hereunder. All agreements of the Company and the holder hereof contained herein shall survive indefinitely until, by their respective terms, they are no longer operative.

19. Remedies. In case any one or more of the covenants and agreements contained in this Warrant shall have been breached, the holders hereof (in the case of a breach by the Company), or the Company (in the case of a breach by a holder), may proceed to protect and enforce their or its rights either by suit in equity and/or by action at law, including, but not limited to, an action for damages as a result of any such breach and/or an action for specific performance of any such covenant or agreement contained in this Warrant.

20. No Impairment of Rights. The Company will not, by amendment of its Charter or through any other means, avoid or seek to avoid the observance or performance of any of the terms of this Warrant, but will at all times in good faith assist in the carrying out of all such terms and in the taking of all such action as may be necessary or appropriate in order to protect the rights of the holder of this Warrant against impairment.

21. Severability. The invalidity or unenforceability of any provision of this Warrant in any jurisdiction shall not affect the validity or enforceability of such provision in any other jurisdiction, or affect any other provision of this Warrant, which shall remain in full force and effect.

22. Recovery of Litigation Costs. If any legal action or other proceeding is brought for the enforcement of this Warrant, or because of an alleged dispute, breach, default, or misrepresentation in connection with any of the provisions of this Warrant, the successful or prevailing party or parties shall be entitled to recover reasonable attorneys' fees and other costs incurred in that action or proceeding, in addition to any other relief to which it or they may be entitled.

23. Entire Agreement Modification. This Warrant constitutes the entire agreement between the parties pertaining to the subject matter contained in it and supersedes all prior and contemporaneous agreement, representations, and undertakings of the parties, whether oral or written, with respect to such subject matter.

[Remainder of page intentionally blank. Signature page follows]

The Company has caused this Warrant to be duly executed and delivered as of the Date of Grant specified above.

ENPHASE ENERGY, INC.

By: /s/ Paul Nahi

Name: Paul Nahi

Title: President & Chief Executive Officer

Address: 201 1st Street, Suite 300
Petaluma, CA 94952

EXHIBIT A-1

NOTICE OF EXERCISE

To: ENPHASE ENERGY, INC. (the "Company")

1. The undersigned hereby:

- elects to purchase _____ shares of [Series Preferred Stock] [Common Stock] of the Company pursuant to the terms of the attached Warrant, and tenders herewith payment of the purchase price of such shares in full, or
- elects to exercise its net issuance rights pursuant to Section 10.2 of the attached Warrant with respect to _____ Shares of [Series Preferred Stock] [Common Stock].

2. Please issue a certificate or certificates representing _____ shares in the name of the undersigned or in such other name or names as are specified below:

(Name)

(Address)

3. The undersigned represents that the aforesaid shares are being acquired for the account of the undersigned for investment and not with a view to, or for resale in connection with, the distribution thereof and that the undersigned has no present intention of distributing or reselling such shares, all except as in compliance with applicable securities laws.

(Signature)

(Date)

NOTICE OF EXERCISE

To: ENPHASE ENERGY, INC. (the "Company")

1. Contingent upon and effective immediately prior to the closing (the "Closing") of the Company's public offering contemplated by the Registration Statement on Form S____, filed _____, 200__, the undersigned hereby:

- elects to purchase _____ shares of [Series Preferred Stock] [Common Stock] of the Company (or such lesser number of shares as may be sold on behalf of the undersigned at the Closing) pursuant to the terms of the attached Warrant, or
- elects to exercise its net issuance rights pursuant to Section 10.2 of the attached Warrant with respect to _____ Shares of [Series Preferred Stock] [Common Stock].

2. Please deliver to the custodian for the selling shareholders a stock certificate representing such _____ shares.

3. The undersigned has instructed the custodian for the selling shareholders to deliver to the Company \$_____ or, if less, the net proceeds due the undersigned from the sale of shares in the aforesaid public offering. If such net proceeds are less than the purchase price for such shares, the undersigned agrees to deliver the difference to the Company prior to the Closing.

(Signature)

(Date)

THESE SECURITIES HAVE NOT BEEN REGISTERED UNDER THE SECURITIES ACT OF 1933, AS AMENDED, OR ANY STATE SECURITIES LAWS. THEY MAY NOT BE SOLD, OFFERED FOR SALE, PLEDGED, OR HYPOTHECATED IN THE ABSENCE OF AN EFFECTIVE REGISTRATION STATEMENT RELATED THERETO OR AN OPINION OF COUNSEL (WHICH MAY BE COMPANY COUNSEL) REASONABLY SATISFACTORY TO THE COMPANY THAT SUCH REGISTRATION IS NOT REQUIRED UNDER THE SECURITIES ACT OF 1933, AS AMENDED, OR ANY APPLICABLE STATE SECURITIES LAWS.

WARRANT AGREEMENT

To Purchase Shares of Preferred Stock of

ENPHASE ENERGY, INC.

Dated as of June 13, 2011 (the "Effective Date")

WHEREAS, ENPHASE ENERGY, INC., a Delaware corporation (the "Company"), has entered into a Loan and Security Agreement of even date herewith (the "Loan Agreement") with Hercules Technology Growth Capital, Inc., a Maryland corporation (the "Warrantholder");

WHEREAS, the Company desires to grant to Warrantholder, in consideration for, among other things, the financial accommodations provided for in the Loan Agreement, the right to purchase shares of Preferred Stock (as defined below) pursuant to this Warrant Agreement (the "Agreement");

NOW, THEREFORE, in consideration of the Warrantholder executing and delivering the Loan Agreement and providing the financial accommodations contemplated therein, and in consideration of the mutual covenants and agreements contained herein, the Company and Warrantholder agree as follows:

SECTION 1. GRANT OF THE RIGHT TO PURCHASE PREFERRED STOCK.

For value received, the Company hereby grants to the Warrantholder, and the Warrantholder is entitled, upon the terms and subject to the conditions hereinafter set forth, to subscribe for and purchase, from the Company, up to \$225,000 of fully paid and non-assessable shares of the Preferred Stock at the Exercise Price (as defined below). As used herein, the following terms shall have the following meanings:

"1934 Act" has the meaning given to it in Section 10(d).

"Acknowledgment of Exercise" has the meaning given to it in Section 3(a).

"Act" means the Securities Exchange Act of 1933, as amended.

"Charter" means the Company's Articles of Incorporation, Certificate of Incorporation or other constitutional document, as may be amended from time to time.

"Common Stock" means the Company's common stock, \$0.00001 par value per share.

"Conversion Price Per Share" means, with respect to a Convertible Debt Financing that is the Next Financing, the lesser of the (i) the specified amount component of the conversion price as specified in the closing date documentation of such Convertible Debt Financing and (ii) the actual conversion price for such Convertible Debt Financing as determined on the date of exercise of the Warrant.

“Exercise Price” means, (i) if the Next Financing occurs within 30 days of the Effective Date, the purchase price per share or the Conversion Price Per Share, as applicable, of the Next Financing, (ii) if the Next Financing occurs after the 30th day following the Effective Date but prior to the 180th day following the Effective Date, the average of \$0.68 and the purchase price per share or the Conversion Price Per Share, as applicable, of the Next Financing and, (iii) if the Next Financing occurs after the 180th day following the Effective Date, \$0.68. The Exercise Price is subject to adjustment as provided in Section 8.

“Initial Public Offering” means the initial underwritten public offering of the Company’s Common Stock pursuant to a registration statement under the Act, which public offering has been declared effective by the Securities and Exchange Commission (“SEC”).

“Merger Event” means (i) a merger or consolidation involving the Company in which (x) the Company is not the surviving entity, or (y) the outstanding shares of the Company’s capital stock are otherwise converted into or exchanged for shares of capital of another entity; or (ii) the sale of all or substantially all of the assets of the Company.

“Net Issuance” has the meaning given to it in Section 3(a).

“Next Financing” means the earliest of (i) the next institutional private equity financing with gross proceeds of at least \$12,000,000, (ii) the next convertible debt financing with gross proceeds of at least \$12,000,000 (a “Convertible Debt Financing”), or (iii) the Initial Public Offering.

“Notice of Exercise” has the meaning given to it in Section 3(a).

“Preferred Stock” means the Series E Preferred Stock of the Company and any other stock into or for which the Series E Preferred Stock may be converted or exchanged, and upon and after the occurrence of an event which results in the automatic or voluntary conversion, redemption or retirement of all (but not less than all) of the outstanding shares of such Preferred Stock, including, without limitation, the consummation of an Initial Public Offering of the Common Stock in which such a conversion occurs, then from and after the date upon which such outstanding shares are so converted, redeemed or retired, “Preferred Stock” shall mean such Common Stock.

“Purchase Price” means, with respect to any exercise of this Agreement, an amount equal to the Exercise Price as of the relevant time multiplied by the number of shares of Preferred Stock requested to be exercised under this Agreement pursuant to such exercise.

“Transfer Notice” has the meaning given to it in Section 11.

“Warrant” has the meaning given to it in Section 2.

In addition, capitalized terms used herein but not otherwise defined herein shall have the meaning assigned to such terms in the Loan Agreement.

SECTION 2. TERM OF THE AGREEMENT.

Except as otherwise provided for herein, the term of this Agreement and the right to purchase Preferred Stock as granted herein (the “Warrant”) shall commence on the Effective Date and shall be exercisable for a period ending upon the later to occur of (i) ten (10) years from the Effective Date; or (ii) five (5) years after the Initial Public Offering.

SECTION 3. EXERCISE OF THE PURCHASE RIGHTS.

(a) Exercise. The purchase rights set forth in this Agreement are exercisable by the Warrantholder, in whole or in part, at any time, or from time to time, prior to the expiration of the term set forth in Section 2, by tendering to the Company at its principal office a notice of exercise in the form attached hereto as Exhibit I (the “Notice of Exercise”), duly completed and executed. Promptly upon receipt of the Notice of Exercise and the payment of the Purchase Price in accordance with the terms set forth below, and in no event later than three (3) days thereafter, the Company shall issue to the Warrantholder a certificate for the number of shares of Preferred Stock purchased and shall execute the acknowledgment of exercise in the form attached hereto as Exhibit II (the “Acknowledgment of Exercise”) indicating the number of shares which remain subject to future purchases, if any.

The Purchase Price may be paid at the Warrantholder’s election either (i) by cash or check, or (ii) by surrender of all or a portion of the Warrant for shares of Preferred Stock to be exercised under this Agreement and, if applicable, an amended Agreement representing the remaining number of shares purchasable hereunder, as determined below (“Net Issuance”). If the Warrantholder elects the Net Issuance method, the Company will issue Preferred Stock in accordance with the following formula:

$$X = \frac{Y(A-B)}{A}$$

Where: X = the number of shares of Preferred Stock to be issued to the Warrantholder.

Y = the number of shares of Preferred Stock requested to be exercised under this Agreement.

A = the fair market value of one (1) share of Preferred Stock at the time of issuance of such shares of Preferred Stock.

B = the Exercise Price.

For purposes of the above calculation, current fair market value of Preferred Stock shall mean with respect to each share of Preferred Stock:

(i) if the exercise is in connection with an Initial Public Offering, and if the Company’s registration statement relating to such Initial Public Offering has been declared effective by the SEC, then the fair market value per share shall be the product of (x) the initial “Price to Public” of the Common Stock specified in the final prospectus with respect to the offering and (y) the number of shares of Common Stock into which each share of Preferred Stock is convertible at the time of such exercise;

(ii) if the exercise is after, and not in connection with an Initial Public Offering, and:

(A) if the Common Stock is traded on a securities exchange, the fair market value shall be deemed to be the product of (x) the average of the closing prices over a five (5) day period ending three days before the day the current fair market value of the securities is being determined and (y) the number of shares of Common Stock into which each share of Preferred Stock is convertible at the time of such exercise; or

(B) if the Common Stock is traded over-the-counter, the fair market value shall be deemed to be the product of (x) the average of the closing bid and asked prices quoted on the NASDAQ system (or similar system) over the five (5)

day period ending three days before the day the current fair market value of the securities is being determined and (y) the number of shares of Common Stock into which each share of Preferred Stock is convertible at the time of such exercise;

(iii) if at any time the Common Stock is not listed on any securities exchange or quoted in the NASDAQ National Market or the over-the-counter market, the current fair market value of Preferred Stock shall be the product of (x) the highest price per share which the Company could obtain from a willing buyer (not a current employee or director) for shares of Common Stock sold by the Company, from authorized but unissued shares, as determined in good faith by its Board of Directors and (y) the number of shares of Common Stock into which each share of Preferred Stock is convertible at the time of such exercise, unless the Company shall become subject to a Merger Event, in which case the fair market value of Preferred Stock shall be deemed to be the per share value received by the holders of the Company's Preferred Stock on a common equivalent basis pursuant to such Merger Event.

Upon partial exercise by either cash or Net Issuance, the Company shall promptly issue an amended Agreement representing the remaining number of shares purchasable hereunder. All other terms and conditions of such amended Agreement shall be identical to those contained herein, including, but not limited to the Effective Date hereof.

(b) Exercise Prior to Expiration. To the extent this Agreement is not previously exercised as to all Preferred Stock subject hereto, and if the fair market value of one share of the Preferred Stock is greater than the Exercise Price then in effect, this Agreement shall be deemed automatically exercised pursuant to Section 3(a) (even if not surrendered) immediately before its expiration. For purposes of such automatic exercise, the fair market value of one share of the Preferred Stock upon such expiration shall be determined pursuant to Section 3(a). To the extent this Agreement or any portion thereof is deemed automatically exercised pursuant to this Section 3(b), the Company agrees to promptly notify the Warrantholder of the number of shares of Preferred Stock, if any, the Warrantholder is to receive by reason of such automatic exercise.

SECTION 4. RESERVATION OF SHARES.

During the term of this Agreement, the Company will at all times have authorized and reserved a sufficient number of shares of its Preferred Stock to provide for the exercise of the rights to purchase Preferred Stock as provided for herein, and shall have authorized and reserved a sufficient number of shares of its Common Stock to provide for the conversion of the Preferred Shares available hereunder.

SECTION 5. NO FRACTIONAL SHARES OR SCRIP.

No fractional shares or scrip representing fractional shares shall be issued upon the exercise of the Warrant provided for in this Agreement, but in lieu of such fractional shares the Company shall make a cash payment therefor upon the basis of the Exercise Price then in effect.

SECTION 6. NO RIGHTS AS SHAREHOLDER/STOCKHOLDER.

This Agreement does not entitle the Warrantholder to any voting rights or other rights as a shareholder/stockholder of the Company prior to the exercise of this Agreement.

SECTION 7. WARRANTHOLDER REGISTRY.

The Company shall maintain a registry showing the name and address of the registered holder of this Agreement. Warrantholder's initial address, for purposes of such registry, is set forth in Section 12(g). Warrantholder may change such address by giving written notice of such changed address to the Company.

SECTION 8. ADJUSTMENT RIGHTS.

The Exercise Price and the number of shares of Preferred Stock purchasable hereunder are subject to adjustment, as follows:

(a) Merger Event. If at any time there shall be a Merger Event, then, as a part of such Merger Event, lawful provision shall be made so that the Warrantholder shall thereafter be entitled to receive, upon exercise of this Agreement, the kind, amount and value of shares of preferred stock or other securities or property of the successor, surviving or purchasing corporation resulting from, or participating in, such Merger Event that would have been issuable if Warrantholder had exercised this Agreement immediately prior to the Merger Event. In any such case, appropriate adjustment (as determined in good faith by the Company's Board of Directors) shall be made in the application of the provisions of this Agreement with respect to the rights and interests of the Warrantholder after the Merger Event to the end that the provisions of this Agreement (including adjustments of the Exercise Price) shall be applicable in their entirety, and to the greatest extent possible. Without limiting the foregoing, in connection with any Merger Event, upon the closing thereof, the successor, surviving or purchasing entity shall assume the obligations of this Agreement. The provisions of this Section 8(a) shall similarly apply to successive Merger Events. In connection with a Merger Event and upon Warrantholder's written election to the Company, the Company shall cause this Warrant Agreement to be exchanged for the consideration that Warrantholder would have received if Warrantholder chose to exercise its right to have shares issued pursuant to the Net Issuance provisions of this Warrant Agreement without actually exercising such right, acquiring such shares and exchanging such shares for such consideration.

(b) Reclassification of Shares. Except as set forth in Section 8(a), if the Company at any time shall, by combination, reclassification, exchange or subdivision of securities or otherwise, change any of the securities as to which purchase rights under this Agreement exist into the same or a different number of securities of any other class or classes, this Agreement shall thereafter represent the right to acquire such number and kind of securities as would have been issuable as the result of such change with respect to the securities which were subject to the purchase rights under this Agreement immediately prior to such combination, reclassification, exchange, subdivision or other change.

(c) Subdivision or Combination of Shares. If the Company at any time shall combine or subdivide its Preferred Stock, (i) in the case of a subdivision, the Exercise Price shall be proportionately decreased, and the number of shares of Preferred Stock issuable upon exercise of this Agreement shall be proportionately increased, or (ii) in the case of a combination, the Exercise Price shall be proportionately increased, and the number of shares of Preferred Stock issuable upon the exercise of this Agreement shall be proportionately decreased.

(d) Stock Dividends. If the Company at any time while this Agreement is outstanding and unexpired shall:

(i) pay a dividend with respect to the Preferred Stock payable in Preferred Stock, then the Exercise Price shall be adjusted, from and after the date of determination of shareholders/stockholders entitled to receive such dividend or distribution, to that price determined by multiplying the Exercise Price in effect immediately prior to such date of determination by a fraction (A) the numerator of which shall be the total number of shares of Preferred Stock outstanding immediately prior to such dividend or distribution, and (B) the denominator of which shall be the total number of shares of Preferred Stock outstanding immediately after such dividend or distribution; or

(ii) make any other distribution with respect to Preferred Stock (or stock into which the Preferred Stock is convertible), except any distribution specifically provided for in any other clause of this Section 8, then, in each such case, provision shall be made by the Company such that the Warrantholder shall receive upon exercise or conversion of this Warrant a proportionate share of any such distribution as though it were the holder of the Preferred Stock (or other stock for which the Preferred Stock is convertible) as of the record date fixed for the determination of the shareholders/stockholders of the Company entitled to receive such distribution.

(e) Antidilution Rights. Additional antidilution rights applicable to the Preferred Stock purchasable hereunder are as set forth in the Company's Charter and any other applicable shareholders' rights agreements, and shall be applicable with respect to the Preferred Stock issuable hereunder. The Company shall promptly provide the Warrantholder with any restatement, amendment, modification or waiver of the Charter or any other applicable shareholders' rights agreements; provided, that no such amendment, modification or waiver shall impair or reduce the antidilution rights applicable to the Preferred Stock as of the date hereof unless such amendment, modification or waiver affects the rights of Warrantholder with respect to the Preferred Stock in the same manner as it affects all other holders of Preferred Stock. The Company shall provide Warrantholder with prior written notice of any issuance of its stock or other equity security to occur after the Effective Date of this Agreement, which notice shall include (a) the price at which such stock or security is to be sold, (b) the number of shares to be issued, and (c) such other information as necessary for Warrantholder to determine if a dilutive event has occurred. For the avoidance of doubt, there shall be no duplicate anti-dilution adjustment pursuant to this subsection (e), the foregoing subsection (d) and the Company's Charter.

(f) Notice of Adjustments. If: (i) the Company shall declare any dividend or distribution upon its stock, whether in stock, cash, property or other securities (assuming Warrantholder consents to a dividend involving cash, property or other securities); (ii) the Company shall offer for subscription pro rata to the holders of any class of its Preferred Stock or other convertible stock any additional shares of stock of any class or other rights; (iii) there shall be any Merger Event; (iv) there shall be an Initial Public Offering; or (v) there shall be any voluntary dissolution, liquidation or winding up of the Company; then, in connection with each such event, the Company shall send to the Warrantholder: (A) at least thirty (30) days' prior written notice of the date on which the books of the Company shall close or a record shall be taken for such dividend, distribution, subscription rights (specifying the date on which the holders of Preferred Stock shall be entitled thereto) or for determining rights to vote in respect of such Merger Event, dissolution, liquidation or winding up; (B) in the case of any such Merger Event, dissolution, liquidation or winding up, at least thirty (30) days' prior written notice of the date when the same shall take place (and specifying the date on which the holders of Preferred Stock shall be entitled to exchange their Preferred Stock for securities or other property deliverable upon such Merger Event, dissolution, liquidation or winding up); and (C) in the case of an Initial Public Offering, the Company shall give the Warrantholder at least thirty (30) days' written notice prior to the effective date thereof.

Each such written notice shall set forth, in reasonable detail, (i) the event requiring the notice, and (ii) if any adjustment is required to be made, (A) the amount of such adjustment, (B) the method by which such adjustment was calculated, (C) the adjusted Exercise Price (if the Exercise Price has been adjusted), and (D) the number of shares subject to purchase hereunder after giving effect to such adjustment, and shall be given by first class mail, postage prepaid, or by reputable overnight courier with all charges prepaid, addressed to the Warrantholder at the address for Warrantholder set forth in the registry referred to in Section 7.

(g) Timely Notice. Failure to timely provide such notice required by subsection (f) above shall entitle Warrantholder to retain the benefit of the applicable notice period notwithstanding anything to the contrary contained in any insufficient notice received by Warrantholder. For purposes of this subsection (g), and notwithstanding anything to the contrary in Section 12(g), the notice period shall begin on the date Warrantholder actually receives a written notice containing all the information required to be provided in such subsection (f).

SECTION 9. REPRESENTATIONS, WARRANTIES AND COVENANTS OF THE COMPANY.

(a) Reservation of Preferred Stock. The Preferred Stock issuable upon exercise of the Warrantholder's rights has been duly and validly reserved and, when issued in accordance with the provisions of this Agreement, will be validly issued, fully paid and non-assessable, and will be free of any taxes, liens, charges or encumbrances of any nature whatsoever; provided, that the Preferred Stock issuable pursuant to this Agreement may be subject to restrictions on transfer under state and/or federal securities laws. The Company has made available to the Warrantholder true, correct and complete copies of its Charter and current bylaws. The issuance of certificates for shares of Preferred Stock upon exercise of this Agreement shall be made without charge to the Warrantholder for any issuance tax in respect thereof, or other cost incurred by the Company in connection with such exercise and the related issuance of shares of Preferred Stock; provided, that the Company shall not be required to pay any tax which may be payable in respect of any transfer and the issuance and delivery of any certificate in a name other than that of the Warrantholder.

(b) Due Authority. The execution and delivery by the Company of this Agreement and the performance of all obligations of the Company hereunder, including the issuance to Warrantholder of the right to acquire the shares of Preferred Stock and the Common Stock into which it may be converted have been duly authorized by all necessary corporate action on the part of the Company. This Agreement: (1) does not violate the Company's Charter or current bylaws; (2) does not contravene any law or governmental rule, regulation or order applicable to it; and (3) does not and will not contravene any provision of, or constitute a default under, any indenture, mortgage, contract or other instrument to which it is a party or by which it is bound. This Agreement constitutes a legal, valid and binding agreement of the Company, enforceable in accordance with its terms.

(c) Consents and Approvals. No consent or approval of, giving of notice to, registration with, or taking of any other action in respect of any state, federal or other governmental authority or agency is required with respect to the execution, delivery and performance by the Company of its obligations under this Agreement, except for the filing of notices pursuant to Regulation D under the Act and any filing required by applicable state securities law, which filings will be effective by the time required thereby.

(d) Issued Securities. All issued and outstanding shares of Common Stock, Preferred Stock or any other securities of the Company have been duly authorized and validly issued and are fully paid and nonassessable. All outstanding shares of Common Stock, Preferred Stock and any other securities were issued in full compliance with all federal and state securities laws. In addition, as of the date immediately preceding the Effective Date:

(i) The authorized capital of the Company consists of (A) 308,000,000 shares of Common Stock, of which 8,679,620 shares are issued and outstanding, and (B) 213,912,542 shares of Preferred Stock, consisting of (i) 1,875,000 shares designated as Series A Preferred Stock, of which 1,875,000 shares are issued and outstanding and are convertible into 2,298,753 shares of Common Stock at \$0.261 per share, (ii) 9,672,442 shares designated as Series B Preferred Stock, of which 9,672,442 shares are issued and

outstanding and are convertible into 18,358,296 shares of Common Stock at \$0.349 per share, (iii) 12,065,100 shares designated as Series C Preferred Stock, of which 11,675,878 shares are issued and outstanding and are convertible into 29,353,159 shares of Common Stock at \$0.511 per share, (iv) 115,300,000 shares designated as Series D Preferred Stock, of which 111,071,231 shares are issued and outstanding and are convertible into 111,071,231 shares of Common Stock at \$0.235 per share, and (v) 75,000,000 shares designated as Series E Preferred Stock, of which 67,471,300 shares are issued and outstanding and are convertible into 67,471,300 shares of Common Stock at \$0.68 per share.

(ii) The Company has reserved 68,400,797 shares of Common Stock for issuance under its Stock Option Plan(s), under which 56,194,592 options are outstanding. There are no other options, warrants, conversion privileges or other rights presently outstanding to purchase or otherwise acquire any authorized but unissued shares of the Company's capital stock or other securities of the Company, except (a) warrants to purchase 100,000 shares of Common Stock, (b) warrants to purchase 100,000 shares of Series C Preferred Stock which are convertible into 251,400 shares of Common Stock at \$0.511 per share, and (c) warrants to purchase 1,470,588 shares of Series E Preferred Stock which are convertible into 1,470,588 shares of Common Stock at \$0.68 per share. The Company has no outstanding loans to any employee, officer or director of the Company, and the Company agrees not to enter into any such loan or otherwise guarantee the payment of any loan made to an employee, officer or director by a third party.

(iii) Except as set forth in the Company's Amended and Restated Investors' Rights Agreement, as amended from time to time (the "Rights Agreement"), no stockholder of the Company has preemptive rights to purchase new issuances of the Company's capital stock.

(e) Insurance. The Company has in full force and effect insurance policies, with extended coverage, insuring the Company and its property and business against such losses and risks, and in such amounts, as are customary for corporations engaged in a similar business and similarly situated and as otherwise may be required pursuant to the terms of any other contract or agreement.

(f) Other Commitments to Register Securities. Except as set forth in this Agreement and the Rights Agreement, the Company is not, pursuant to the terms of any other agreement currently in existence, under any obligation to register under the Act any of its presently outstanding securities or any of its securities which may hereafter be issued.

(g) Exempt Transaction. Subject to the accuracy of the Warrantholder's representations in Section 10, the issuance of the Preferred Stock upon exercise of this Agreement, and the issuance of the Common Stock upon conversion of the Preferred Stock will each constitute a transaction exempt from (i) the registration requirements of Section 5 of the Act, in reliance upon Section 4(2) thereof, and (ii) the qualification requirements of the applicable state securities laws.

(h) Compliance with Rule 144. If the Warrantholder proposes to sell Preferred Stock issuable upon the exercise of this Agreement, or the Common Stock into which it is convertible, in compliance with Rule 144 promulgated by the SEC, then, upon Warrantholder's written request to the Company, the Company shall furnish to the Warrantholder, within ten days after receipt of such request, a written statement confirming the Company's compliance with the filing requirements of the SEC as set forth in such Rule, as such Rule may be amended from time to time.

(i) Information Rights. During the term of this Warrant, Warrantholder shall be entitled to the information rights contained in Section 7.1 of the Loan Agreement, and Section 7.1 of the Loan Agreement is hereby incorporated into this Agreement by this reference as though fully set forth herein, provided, however, that the Company shall not be required to deliver a Compliance Certificate once all Indebtedness (as defined in the Loan Agreement) owed by the Company to Warrantholder has been repaid.

SECTION 10. REPRESENTATIONS AND COVENANTS OF THE WARRANTHOLDER.

This Agreement has been entered into by the Company in reliance upon the following representations and covenants of the Warrantholder:

(a) Investment Purpose. The right to acquire Preferred Stock or the Preferred Stock issuable upon exercise of the Warrantholder's rights contained herein will be acquired for investment and not with a view to the sale or distribution of any part thereof, and the Warrantholder has no present intention of selling or engaging in any public distribution of the same except pursuant to a registration or exemption.

(b) Private Issue. The Warrantholder understands (i) that the Preferred Stock issuable upon exercise of this Agreement is not registered under the Act or qualified under applicable state securities laws on the ground that the issuance contemplated by this Agreement will be exempt from the registration and qualifications requirements thereof, and (ii) that the Company's reliance on such exemption is predicated on the representations set forth in this Section 10.

(c) Financial Risk. The Warrantholder has such knowledge and experience in financial and business matters as to be capable of evaluating the merits and risks of its investment, and has the ability to bear the economic risks of its investment.

(d) Risk of No Registration. The Warrantholder understands that if the Company does not register with the SEC pursuant to Section 12 of the Securities Exchange Act of 1934 (the "1934 Act"), or file reports pursuant to Section 15(d) of the 1934 Act, or if a registration statement covering the securities under the Act is not in effect when it desires to sell (i) the rights to purchase Preferred Stock pursuant to this Agreement or (ii) the Preferred Stock issuable upon exercise of the right to purchase, it may be required to hold such securities for an indefinite period. The Warrantholder also understands that any sale of (A) its rights hereunder to purchase Preferred Stock or (B) Preferred Stock issued or issuable hereunder which might be made by it in reliance upon Rule 144 under the Act may be made only in accordance with the terms and conditions of that Rule.

(e) Accredited Investor. Warrantholder is an "accredited investor" within the meaning of the Securities and Exchange Rule 501 of Regulation D, as presently in effect.

(f) Lock-Up Period; Agreement. Warrantholder hereby agrees that it shall not, to the extent requested by the Company or an underwriter of securities of the Company, sell or otherwise transfer or dispose of any Registrable Securities (as defined in the Rights Agreement) or other shares of stock of the Company then owned by such Warrantholder (other than to donees or partners of the Holder who agree to be similarly bound) for up to one hundred eighty (180) days following the effective date of any registration statement of the Company filed under the Securities Act; provided, however, if during the last 17 days of the restricted period the Company issues an earnings release or material news or a material event relating to the Company occurs, or prior to the expiration of the restricted period the Company announces that it will release earnings results during the 16-day period beginning on the last day of the restricted period, and if the Company's securities are listed on the Nasdaq Stock Market and Rule 2711 thereof applies, then the restrictions imposed by this Section 10(f) shall continue to apply until the expiration of the

18-day period beginning on the issuance of the earnings release or the occurrence of the material news or material event. In no event will the restricted period extend beyond two hundred and fifteen (215) days after the effective date of the registration statement.

SECTION 11. TRANSFERS.

Subject to compliance with applicable federal and state securities laws, this Agreement and all rights hereunder are transferable, in whole or in part, without charge to the holder hereof (except for transfer taxes) upon surrender of this Agreement properly endorsed. Each taker and holder of this Agreement, by taking or holding the same, consents and agrees that this Agreement, when endorsed in blank, shall be deemed negotiable, and that the holder hereof, when this Agreement shall have been so endorsed and its transfer recorded on the Company's books, shall be treated by the Company and all other persons dealing with this Agreement as the absolute owner hereof for any purpose and as the person entitled to exercise the rights represented by this Agreement. The transfer of this Agreement shall be recorded on the books of the Company upon receipt by the Company of a notice of transfer in the form attached hereto as Exhibit III (the "Transfer Notice"), at its principal offices and the payment to the Company of all transfer taxes and other governmental charges imposed on such transfer. Until the Company receives such Transfer Notice, the Company may treat the registered owner hereof as the owner for all purposes.

SECTION 12. MISCELLANEOUS.

(a) Effective Date. The provisions of this Agreement shall be construed and shall be given effect in all respects as if it had been executed and delivered by the Company on the date hereof. This Agreement shall be binding upon any successors or assigns of the Company.

(b) Remedies. In the event of any default hereunder, the non-defaulting party reserves its right to protect and enforce its rights either by suit in equity and/or by action at law, including but not limited to an action for damages as a result of any such default; provided, that the parties hereto declare that it is impossible to measure in money the damages which will accrue to Warrantholder by reason of the Company's failure to perform any of the obligations under this Warrant and agree that the terms of this Warrant shall be specifically enforceable by Warrantholder. If Warrantholder institutes any action or proceeding to specifically enforce the provisions hereof, any person against whom such action or proceeding is brought hereby waives the claim or defense therein that Warrantholder has an adequate remedy at law, and such person shall not offer in any such action or proceeding the claim or defense that such remedy at law exists.

(c) No Impairment of Rights. The Company will not, by amendment of its Charter or through any other means, avoid or seek to avoid the observance or performance of any of the terms of this Agreement, but will at all times in good faith assist in the carrying out of all such terms and in the taking of all such actions as may be necessary or appropriate in order to protect the rights of the Warrantholder against impairment. Notwithstanding the foregoing, nothing in this Section 12(c) shall prohibit the Company from amending its Charter with the requisite consent of the stockholders and the Board of Directors so long as such amendment affects the rights granted to Warrantholder associated with the Preferred Stock in the same manner as the other holders of the Preferred Stock.

(d) Additional Documents. The Company, upon execution of this Agreement, shall provide the Warrantholder with certified resolutions with respect to the representations, warranties and covenants set forth in Sections 9(a) through 9(d), 9(f) and 9(g). The Company shall also supply such other documents as the Warrantholder may from time to time reasonably request.

(e) Attorney's Fees. In any litigation, arbitration or court proceeding between the Company and the Warrantholder relating hereto, the prevailing party shall be entitled to attorneys' fees and expenses and all costs of proceedings incurred in enforcing this Agreement. For the purposes of this Section 12(e), attorneys' fees shall include without limitation fees incurred in connection with the following: (i) contempt proceedings; (ii) discovery; (iii) any motion, proceeding or other activity of any kind in connection with an insolvency proceeding; (iv) garnishment, levy, and debtor and third party examinations; and (v) post-judgment motions and proceedings of any kind, including without limitation any activity taken to collect or enforce any judgment.

(f) Severability. In the event any one or more of the provisions of this Agreement shall for any reason be held invalid, illegal or unenforceable, the remaining provisions of this Agreement shall be unimpaired, and the invalid, illegal or unenforceable provision shall be replaced by a mutually acceptable valid, legal and enforceable provision, which comes closest to the intention of the parties underlying the invalid, illegal or unenforceable provision.

(g) Notices. Except as otherwise provided herein, any notice, demand, request, consent, approval, declaration, service of process or other communication that is required, contemplated, or permitted under this Agreement or with respect to the subject matter hereof shall be in writing, and shall be deemed to have been validly served, given, delivered, and received upon the earlier of: (i) the day of transmission by facsimile or hand delivery if transmission or delivery occurs on a business day at or before 5:00 pm in the time zone of the recipient, or, if transmission or delivery occurs on a non-business day or after such time, the first business day thereafter, or the first business day after deposit with an overnight express service or overnight mail delivery service; or (ii) the third calendar day after deposit in the United States mails, with proper first class postage prepaid, and shall be addressed to the party to be notified as follows:

If to Warrantholder:

HERCULES TECHNOLOGY GROWTH CAPITAL, INC.
Legal Department
Attention: Chief Legal Officer and Manuel Henriquez
400 Hamilton Avenue, Suite 310
Palo Alto, CA 94301
Facsimile:
Telephone:

With a copy to:

BINGHAM MCCUTCHEN
Attn: John Connolly
Three Embarcadero Center
San Francisco, CA 94111
Facsimile:
Telephone:

(i) If to the Company:

ENPHASE ENERGY, INC.
Attention: Senior Corporate Counsel
201 First Street, Suite 300
Petaluma, CA 94952

Facsimile:
Telephone:

or to such other address as each party may designate for itself by like notice.

(h) Entire Agreement; Amendments. This Agreement constitutes the entire agreement and understanding of the parties hereto in respect of the subject matter hereof, and supersedes and replaces in their entirety any prior proposals, term sheets, letters, negotiations or other documents or agreements, whether written or oral, with respect to the subject matter hereof (including Warrantholder's proposal letter dated March 30, 2011). None of the terms of this Agreement may be amended except by an instrument executed by each of the parties hereto.

(i) Headings. The various headings in this Agreement are inserted for convenience only and shall not affect the meaning or interpretation of this Agreement or any provisions hereof.

(j) Advice of Counsel. Each of the parties represents to each other party hereto that it has discussed (or had an opportunity to discuss) with its counsel this Agreement and, specifically, the provisions of Sections 12(n), 12(o), 12(p) and 12(q).

(k) No Strict Construction. The parties hereto have participated jointly in the negotiation and drafting of this Agreement. In the event an ambiguity or question of intent or interpretation arises, this Agreement shall be construed as if drafted jointly by the parties hereto and no presumption or burden of proof shall arise favoring or disfavoring any party by virtue of the authorship of any provisions of this Agreement.

(l) No Waiver. No omission or delay by Warrantholder at any time to enforce any right or remedy reserved to it, or to require performance of any of the terms, covenants or provisions hereof by the Company at any time designated, shall be a waiver of any such right or remedy to which Warrantholder is entitled, nor shall it in any way affect the right of Warrantholder to enforce such provisions thereafter.

(m) Survival. All agreements, representations and warranties contained in this Agreement or in any document delivered pursuant hereto shall be for the benefit of Warrantholder and shall survive the execution and delivery of this Agreement and the expiration or other termination of this Agreement.

(n) Governing Law. This Agreement have been negotiated and delivered to Warrantholder in the State of California, and shall have been accepted by Warrantholder in the State of California. Delivery of Preferred Stock to Warrantholder by the Company under this Agreement is due in the State of California. This Agreement shall be governed by, and construed and enforced in accordance with, the laws of the State of California, excluding conflict of laws principles that would cause the application of laws of any other jurisdiction.

(o) Consent to Jurisdiction and Venue. All judicial proceedings arising in or under or related to this Agreement may be brought in any state or federal court of competent jurisdiction located in the State of California. By execution and delivery of this Agreement, each party hereto generally and unconditionally: (a) consents to personal jurisdiction in Santa Clara County, State of California; (b) waives any objection as to jurisdiction or venue in Santa Clara County, State of California; (c) agrees not to assert any defense based on lack of jurisdiction or venue in the aforesaid courts; and (d) irrevocably agrees to be bound by any judgment rendered thereby in connection with this Agreement. Service of process on any party hereto in any action arising out of or relating to this Agreement shall be effective if given in accordance with the requirements for notice set forth in Section 12(g), and shall be deemed effective and received as set forth in

Section 12(g). Nothing herein shall affect the right to serve process in any other manner permitted by law or shall limit the right of either party to bring proceedings in the courts of any other jurisdiction.

(p) Mutual Waiver of Jury Trial. Because disputes arising in connection with complex financial transactions are most quickly and economically resolved by an experienced and expert person and the parties wish applicable state and federal laws to apply (rather than arbitration rules), the parties desire that their disputes be resolved by a judge applying such applicable laws. EACH OF THE COMPANY AND WARRANTHOLDER SPECIFICALLY WAIVES ANY RIGHT IT MAY HAVE TO TRIAL BY JURY OF ANY CAUSE OF ACTION, CLAIM, CROSS-CLAIM, COUNTERCLAIM, THIRD PARTY CLAIM OR ANY OTHER CLAIM (COLLECTIVELY, "CLAIMS") ASSERTED BY THE COMPANY AGAINST WARRANTHOLDER OR ITS ASSIGNEE OR BY WARRANTHOLDER OR ITS ASSIGNEE AGAINST THE COMPANY. This waiver extends to all such Claims, including Claims that involve Persons other than the Company and Warrantholder; Claims that arise out of or are in any way connected to the relationship between the Company and Warrantholder; and any Claims for damages, breach of contract, specific performance, or any equitable or legal relief of any kind, arising out of this Agreement.

(q) Judicial Reference. If the Mutual Waiver of Jury Trial set forth in Section 12(p) is ineffective or unenforceable, the parties agree that all Claims shall be resolved by reference to a private judge sitting without a jury, pursuant to Code of Civil Procedure Section 638, before a mutually acceptable referee or, if the parties cannot agree, a referee selected by the Presiding Judge of Santa Clara County, California. Such proceeding shall be conducted in Santa Clara County, California, with California rules of evidence and discovery applicable to such proceeding. In the event Claims are to be resolved by judicial reference, either party may seek from a court identified in Section 12(o), any prejudgment order, writ or other relief and have such prejudgment order, writ or other relief enforced to the fullest extent permitted by law notwithstanding that all Claims are otherwise subject to resolution by judicial reference.

(r) Counterparts. This Agreement and any amendments, waivers, consents or supplements hereto may be executed in any number of counterparts, and by different parties hereto in separate counterparts, each of which when so delivered shall be deemed an original, but all of which counterparts shall constitute but one and the same instrument.

[Remainder of Page Intentionally Left Blank]

IN WITNESS WHEREOF, the parties hereto have caused this Agreement to be executed by its officers thereunto duly authorized as of the Effective Date.

COMPANY:

ENPHASE ENERGY, INC.

By: /s/ Sanjeev Kumar

Name: _____

Title: _____

WARRANTHOLDER:

HERCULES TECHNOLOGY GROWTH CAPITAL, INC.,

a Maryland corporation

By: /s/ K. Nicholas Martitsch

Name: K. Nicholas Martitsch

Its: Associate General Counsel

[Signature Page to Warrant Agreement]

EXHIBIT I

NOTICE OF EXERCISE

To: ENPHASE ENERGY, INC. (the "Company")

- (1) The undersigned Warrantholder hereby elects to purchase [_____] shares of the [] Preferred Stock of the Company, pursuant to the terms of that certain Warrant Agreement, dated as of June 13, 2011, between the Company and the Warrantholder (the "Agreement"), and [CASH PAYMENT: tenders herewith payment of the Purchase Price in full, together with all applicable transfer taxes, if any.] [NET ISSUANCE: elects pursuant to Section 3(a) of the Agreement to effect a Net Issuance.]
- (2) Please issue a certificate or certificates representing said shares of [] Preferred Stock in the name of the Warrantholder or in such other name as is specified below.

WARRANTHOLDER:

HERCULES TECHNOLOGY GROWTH CAPITAL, INC.,
a Maryland corporation

By: _____

Name: K. Nicholas Martitsch

Its: Associate General Counsel

EXHIBIT II

ACKNOWLEDGMENT OF EXERCISE

The undersigned, as representative of Enphase Energy, Inc. (the "Company"), hereby acknowledges receipt of the "Notice of Exercise" from Hercules Technology Growth Capital, Inc. (the "Warrantholder"), to purchase [_____] shares of the [] Preferred Stock of the Company, pursuant to the terms of that certain Warrant Agreement, dated as of June 13, 2011, between the Company and the Warrantholder (the "Agreement"), and further acknowledges that [_____] shares remain subject to purchase under the terms of the Agreement.

COMPANY:

ENPHASE ENERGY, INC.

By: _____

Title: _____

Date: _____

EXHIBIT III

TRANSFER NOTICE

FOR VALUE RECEIVED, that certain Warrant Agreement, dated as of June 13, 2011, between Enphase Energy, Inc. and Hercules Technology Growth Capital, Inc., as the Warrantholder (the "Agreement"), and all rights evidenced thereby are hereby transferred and assigned to

(Please Print)

whose address is _____

Dated: _____

Holder's Signature: _____

Holder's Address: _____

Signature Guaranteed: _____

NOTE: The signature to this Transfer Notice must correspond with the name as it appears on the face of the Agreement, without alteration or enlargement or any change whatever. Officers of corporations and those acting in a fiduciary or other representative capacity should file proper evidence of authority to assign the foregoing Agreement.

January 1, 2007

Mr. Paul B. Nahi

Dear Paul:

PVI Solutions, Inc. (the "**Company**") is pleased to offer you employment on the following terms:

1. **Position.** Your title will be President and Chief Executive Officer, and you will report to the Company's Board of Directors. This is a full-time position. While you render services to the Company, you will not engage in any other employment, consulting or other business activity (whether full-time or part-time) that would create a conflict of interest with your duties to the Company. So long as you remain the Chief Executive Officer of the Company, you will be appointed to the Board of Directors of the Company promptly (but in no event more than 30 days) following the date of this letter agreement, and thereafter recommended by the Board of Directors for reelection in connection with subsequent elections of directors. By signing this letter agreement, you confirm to the Company that you have no contractual commitments or other legal obligations that would prohibit you from performing your duties for the Company.

2. **Cash Compensation.** The Company will pay you a starting salary at the rate of sixty thousand dollars (\$60,000.00) per year, payable in accordance with the Company's standard payroll schedule. Your salary will be increased to one hundred and ninety thousand dollars (\$190,000.00) per year upon the receipt of minimum aggregate gross proceeds to the Company of \$4 Million in connection with a Series B Preferred Stock offering (the "**Financing**"). Your salary, together with the other benefits provided for herein, will be subject to review by the Board of Directors of the Company annually or more often, with the first such review to occur on or before January 1, 2008 (the "**First Review**"). Within 30 days following the date of this letter agreement you and the Board of Directors shall agree on a set of performance criteria (the "**Performance Criteria**") to be evaluated at the First Review.

3. **Employee Benefits.** As a regular employee of the Company, you will be eligible to participate in regular health insurance, profit sharing, bonus, and other employee benefit plans if and as established by the Company for its employees from time to time at levels applicable to the Company's senior management. The Company will make an annual matching contribution on your behalf to the Company's 401(k) Plan of three percent (3%) of your gross salary for the preceding 12-month period based on the salary amounts as set forth in Section 2 above. The Company may change or cease to make these contributions at any time for any reason with or without notice, provided, however, to the extent the Company reduces its contributions from this three percent (3%) level, your salary will be increased by an equivalent

amount. In addition, you will be entitled to paid vacation at levels applicable to the Company's senior management in accordance with the Company's vacation policy, as in effect from time to time.

4. **Expenses.** You will be reimbursed for reasonable legitimate business expenses incurred in the performance of your duties.

5. **Stock Grants.** Promptly following execution of this letter agreement, you will be granted nine hundred and fifty-two thousand (952,000) shares of Common Stock of the Company ("**Initial Shares**") under the Company's 2006 Equity Incentive Plan, as amended to permit the full issuance of such shares (the "**Plan**") at a purchase price per share equal to \$0.0001 per share (which amount is equal to the par value per share of such shares). All shares of Common Stock you receive or purchase from the Company under this Agreement will be subject to repurchase at such price and will be subject to the other terms and conditions applicable to shares granted under the Plan, as described in the Plan and the applicable stock purchase agreement. Subject to your continued employment and the terms and conditions of the Plan, twenty-five percent (25%) of the shares will vest and no longer be subject to the Company's repurchase right on the date that is twelve (12) months following January 1, 2007, and the balance will vest in equal monthly installments over the next thirty-six (36) months of continuous service, as described in the applicable stock purchase agreement.

Upon the final closing of the Financing (the "**Closing**"), you will be granted an additional number of shares of Common Stock that results in your holding, in addition to the Initial Shares, a number of shares of Common Stock equal to (a) six and one-half percent (6.5%) of the number of fully-diluted shares of Common Stock then outstanding (including: all outstanding shares of Common Stock, all outstanding shares of Preferred Stock issued through the Closing on an as-converted to Common Stock basis, the full number of shares of Common Stock issuable upon exercise of all outstanding warrants and upon conversion all Preferred Stock issuable upon exercise of all outstanding warrants, and the full number of shares of Common Stock issuable under all other options, warrants and equity plans of the Company in effect as of the Closing, the "**Fully Diluted Shares**"), less (b) the Initial Shares (such resulting number, the "**Closing Shares**"), at a purchase price per share equal to \$0.0001 per share.

If the Board of Directors at the First Review determines, in the exercise of its reasonable discretion, that you have met the Performance Criteria in all material respects, you will be granted the opportunity to purchase an additional number of shares of Common Stock that results in your holding, in addition to the Initial Shares and the Closing Shares, a number of shares of Common Stock equal to (a) seven percent (7%) of the number of Fully Diluted Shares, less (b) the Initial Shares plus the Closing Shares, at a purchase price per share equal to the then-current fair market value per share of the Company's Common Stock as determined in good faith by the Board.

You will be responsible for making an election pursuant to Section 83(b) of the Internal Revenue Code with respect to all such shares within thirty (30) days following each issuance of such shares.

6. Severance Benefits.

(A) In the event that the Company terminates your employment without Cause (as defined below) or you voluntarily resign from your employment with Good Reason (as defined below): (i) the Company shall pay to you promptly (but in no event more than 5 days following such termination or resignation), a lump sum equal to (a) your base salary accrued through the date of termination or resignation, (b) all accrued vacation pay and accrued bonuses, if any, to the date of termination or resignation, and (c) an amount equal to three (3) months of your base salary at the higher of (I) the rate in effect on the date of notice of termination or resignation and (II) the rate in effect six months prior to the date of notice of termination or resignation, (ii) the Company shall provide, at the Company's expense, continuation coverage to you and your dependents under any health plan(s) of the Company adopted after the date of this letter agreement in which you participated on the date of termination or resignation, or in the event any such health plan is not continued or you are not eligible for coverage thereunder due to your termination or resignation, the Company shall pay for the premiums for equivalent coverage, in any event, for a period of three (3) months after the date of termination or resignation, and (iii) notwithstanding anything to the contrary contained herein or in any agreement with respect hereto; (a) twenty-five percent (25%) of each restricted equity grants, equity options and similar rights originally granted to you with respect to securities of the Company, including twenty-five percent (25%) of the stock described in Section 5 above, shall automatically become fully vested and, to the extent of any unexercised right, shall become immediately exercisable; and (b) if such termination or resignation occurs in connection with or following a Change of Control, upon such termination or resignation, **all** of such restricted equity grants, equity options and similar rights held by you with respect to securities of the Company, including the stock grants described in Section 5 above, shall automatically become fully vested and, to the extent of any unexercised right, shall become immediately exercisable. Each unexercised right shall remain exercisable for a period of twelve (12) months following such termination or resignation, provided that you understand that any option that is an Incentive Stock Option under Section 422 of the Internal Revenue Code will become a nonqualified option if the option is not exercised within 90 days following such termination or resignation.

(B) For purposes of this letter agreement. "**Cause**" means (i) you have intentionally engaged in unfair competition with the Company, intentionally induced a significant customer of the Company to breach any contract with the Company, intentionally made an unauthorized disclosure of material confidential information of the Company or otherwise intentionally breached a contract between you and the Company (including this Agreement and the Employee Invention Assignment and Confidentiality Agreement attached hereto as Exhibit A), committed an act of embezzlement, fraud or theft with respect to the property of the Company, or deliberately disregarded the rules of the Company, in any such event in such a manner as to cause material loss, damage or injury to, or otherwise materially to endanger or damage the business, property, reputation or employees of, the Company, (ii) you have repeatedly abused alcohol or drugs on the job or in a manner affecting his job performance,

or (iii) you have been found guilty of or have plead nolo contendere to the commission of a felony offense.

(C) For purposes of this letter agreement, "**Change of Control**" means: (i) any "person" (as such term is used in Sections 13(d) and 14(d) of the Securities Exchange Act of 1934, as amended) is or becomes the "beneficial owner" (as defined in Rule 13d-3 under said Act), directly or indirectly, of securities of the Company representing a majority of the total voting power represented by the Company's then outstanding voting securities (except for bona fide financings of the Company); or (ii) the date of the consummation of a merger or consolidation of the Company with any other corporation that has been approved by the stockholders of the Company, other than a merger or consolidation which would result in the voting securities of the Company outstanding immediately prior thereto continuing to represent (either by remaining outstanding or by being converted into voting securities of the surviving entity) a majority of the total voting power represented by the voting securities of the Company or such surviving entity outstanding immediately after such merger or consolidation, or the stockholders of the Company approve a plan of complete liquidation of the Company; or (iii) the date of the consummation of the sale or disposition by the Company of all or substantially all the Company's assets.

(D) For purposes of this letter agreement, "**Good Reason**" means: (i) without your written consent, the assignment of you to any duties materially inconsistent with, or any adverse change in, your positions, duties, responsibilities or status as President and Chief Executive Officer of the Company, or the removal of you from, or failure to reelect you to, any of such positions, (ii) a reduction by the Company in your base salary other than a proportionate reduction in the base salaries of all executive officers of the Company, (iii) the Company requiring you to be based in excess of 50 miles from the Company's present executive offices, (iv) the failure of the Company to continue in effect for you any material benefit now or hereafter made available to the Company's senior management, or (v) any material breach by the Company of this letter agreement which is not cured within ten (10) days of notice thereof by you to the Company, or the material breach by the Company of this letter agreement three or more times (whether or not the breaches are the same and whether or not the breaches are subsequently cured) in any twelve month period.

7. Indemnification. As an employee, officer and agent of the Company, you shall be fully indemnified by the Company to the fullest extent permitted by California law. To implement this provision, Company shall execute and deliver to you its standard form of indemnification agreement for officers and directors, and you shall thereafter be entitled to the benefits of any subsequent amendments thereto made for any management executives.

8. No Termination. This letter agreement shall not be terminated by any voluntary or involuntary dissolution of the Company or by the transfer of all or substantially all the assets of the Company or the merger of the Company with or into another entity.

9. **Confidentiality.** As an employee of the Company, you will have access to certain confidential information of the Company and you may, during the course of your employment, develop certain information or inventions that will be the property of the Company. To protect the interests of the Company, you will need to sign the Company's standard "Employee Invention Assignment and Confidentiality Agreement" attached hereto as Exhibit A as a condition of your employment. We wish to impress upon you that we do not want you to, and we hereby direct you not to, bring with you any confidential or proprietary material of any former employer or to violate any other obligations you may have to any former employer. During the period that you render services to the Company, you agree to not engage in any employment, business or activity that is in any way competitive with the business or proposed business of the Company. You will disclose to the Company in writing any other gainful employment, business or activity that you are currently associated with or participate in that competes with the Company. You will not assist any other person or organization in competing with the Company or in preparing to engage in competition with the business or proposed business of the Company. You represent that your signing of this offer letter, agreement(s) concerning stock granted to you, if any, under the Plan and the Company's Employee Invention Assignment and Confidentiality Agreement and your commencement of employment with the Company will not violate any agreement currently in place between yourself and current or past employers.

10. **Employment Relationship.** Employment with the Company is for no specific period of time. Your employment with the Company will be "at will," meaning that either you or the Company may terminate your employment at any time and for any reason, with or without cause. Any contrary representations that may have been made to you are superseded by this letter agreement. This is the full and complete agreement between you and the Company on this term. Although your job duties, title, compensation and benefits, as well as the Company's personnel policies and procedures, may change from time to time subject to the terms of this letter agreement (including Section 6 hereof), the "at will" nature of your employment may only be changed in an express written agreement signed by you and a duly authorized officer of the Company (other than you).

11. **Withholding Taxes.** All forms of compensation referred to in this letter agreement are subject to reduction to reflect applicable withholding and payroll taxes and other deductions required by law.

12. **Interpretation, Amendment and Enforcement.** This letter agreement and Exhibit A constitute the complete agreement between you and the Company, contain all of the terms of your employment with the Company and supersede any prior agreements, representations or understandings (whether written, oral or implied) between you and the Company. This letter agreement may not be amended or modified, except by an express written agreement signed by both you and a duly authorized officer of the Company. The terms of this letter agreement and the resolution of any disputes as to the meaning, effect, performance or validity of this letter agreement or arising out of, related to, or in any way connected with, this letter agreement, your employment with the Company or any other relationship between you and the Company (the "**Disputes**") will be governed by California law, excluding laws relating to

conflicts or choice of law. You and the Company submit to the exclusive personal jurisdiction of the federal and state courts located in San Francisco and Sonoma County in connection with any Dispute or any claim related to any Dispute. In the event of litigation under this letter agreement (including enforcing judgments and appeals), the prevailing party shall be entitled to reimbursement of its reasonable attorneys' fees and costs of suit in addition to such other relief as may be granted.

* * * * *

We hope that you will accept our offer to join the Company on the terms of this letter. You may indicate your agreement with these terms and accept this offer by signing and dating both the enclosed duplicate original of this letter agreement and the enclosed Proprietary Information and Inventions Agreement and returning them to me. This offer, if not accepted, will expire at the close of business on January 24, 2007. As required by law, your employment with the Company is contingent upon your providing legal proof of your identity and authorization to work in the United States.

Very truly yours,

PVI SOLUTIONS, INC.

By: /s/ Raghuveer R. Belur
Raghuveer R. Belur

Title: Member of the Board

I have read and accept this employment offer:

/s/ Paul Nahi
Signature of Paul Nahi

Dated: 1/1/07

EXHIBIT A

Employee Invention Assignment and Confidentiality Agreement

**EMPLOYEE INVENTION ASSIGNMENT AND
CONFIDENTIALITY AGREEMENT**

In consideration of, and as a condition of my employment with PVI Solutions, Inc., a Delaware corporation (the “*Company*”), I hereby represent to, and agree with the Company as follows:

1. **Purpose of Agreement.** I understand that the Company is engaged in a continuous program of research, development, production and marketing in connection with its business and that it is critical for the Company to preserve and protect its “*Proprietary Information*” (as defined in Section 7 below), its rights in “*Inventions*” (as defined in Section 2 below) and in all related intellectual property rights. Accordingly, I am entering into this Employee Invention Assignment and Confidentiality Agreement (this “*Agreement*”) as a condition of my employment with the Company, whether or not I am expected to create inventions of value for the Company.

2. **Disclosure of Inventions.** I will promptly disclose in confidence to the Company all inventions, improvements, designs, original works of authorship, formulas, processes, compositions of matter, computer software programs, databases, mask works, designs and trade secrets that I make or conceive or first reduce to practice or create, either alone or jointly with others, during the period of my employment, whether or not in the course of my employment, and whether or not patentable, copyrightable or protectable as trade secrets (the “*Inventions*”).

3. **Work for Hire; Assignment of Inventions.** I acknowledge and agree that any copyrightable works prepared by me within the scope of my employment are “works for hire” under the Copyright Act and that the Company will be considered the author and owner of such copyrightable works. I agree that all Inventions that (i) are developed using equipment, supplies, facilities or trade secrets of the Company, (ii) result from work performed by me for the Company, or (iii) relate to the Company’s business or current or anticipated research and development (the “*Assigned Inventions*”), will be the sole and exclusive property of the Company and are hereby irrevocably assigned by me to the Company.

4. **Labor Code Section 2870 Notice.** I have been notified and understand that the provisions of Section 3 and 5 of this Agreement do not apply to any Assigned Invention that qualifies fully under the provisions of Section 2870 of the California Labor Code, which states as follows:

ANY PROVISION IN AN EMPLOYMENT AGREEMENT WHICH PROVIDES THAT AN EMPLOYEE SHALL ASSIGN, OR OFFER TO ASSIGN, ANY OF HIS OR HER RIGHTS IN AN INVENTION TO HIS OR HER EMPLOYER SHALL NOT APPLY TO AN INVENTION THAT THE EMPLOYEE DEVELOPED ENTIRELY ON HIS OR HER OWN TIME WITHOUT USING THE EMPLOYER’S EQUIPMENT, SUPPLIES, FACILITIES, OR TRADE SECRET INFORMATION EXCEPT FOR THOSE INVENTIONS THAT EITHER: (I) RELATE AT THE TIME OF CONCEPTION OR REDUCTION TO PRACTICE OF THE INVENTION TO THE

EMPLOYER'S BUSINESS, OR ACTUAL OR DEMONSTRABLY ANTICIPATED RESEARCH OR DEVELOPMENT OF THE EMPLOYER; OR (2) RESULT FROM ANY WORK PERFORMED BY THE EMPLOYEE FOR THE EMPLOYER. TO THE EXTENT A PROVISION IN AN EMPLOYMENT AGREEMENT PURPORTS TO REQUIRE AN EMPLOYEE TO ASSIGN AN INVENTION OTHERWISE EXCLUDED FROM BEING REQUIRED TO BE ASSIGNED UNDER CALIFORNIA LABOR CODE SECTION 2870(a), THE PROVISION IS AGAINST THE PUBLIC POLICY OF THIS STATE AND IS UNENFORCEABLE.

5. **Assignment of Other Rights.** In addition to the foregoing assignment of Assigned Inventions to the Company, I hereby irrevocably transfer and assign to the Company: (i) all worldwide patents, patent applications, copyrights, mask works, trade secrets and other intellectual property rights, including but not limited to rights in databases, in any Assigned Inventions, along with any registrations of or applications to register such rights; and (ii) any and all "Moral Rights" (as defined below) that I may have in or with respect to any Assigned Inventions. I also hereby forever waive and agree never to assert any and all Moral Rights I may have in or with respect to any Assigned Inventions, even after termination of my work on behalf of the Company. "**Moral Rights**" mean any rights to claim authorship of or credit on an Assigned Inventions, to object to or prevent the modification or destruction of any Assigned Inventions, or to withdraw from circulation or control the publication or distribution of any Assigned Inventions, and any similar right, existing under judicial or statutory law of any country or subdivision thereof in the world, or under any treaty, regardless of whether or not such right is denominated or generally referred to as a "moral right."

6. **Assistance.** I agree to assist the Company in every proper way to obtain for the Company and enforce patents, copyrights, mask work rights, trade secret rights and other legal protections for the Company's Assigned Inventions in any and all countries. I will execute any documents that the Company may reasonably request for use in obtaining or enforcing such patents, copyrights, mask work rights, trade secrets and other legal protections. My obligations under this paragraph will continue beyond the termination of my employment with the Company, provided that the Company will compensate me at a reasonable rate after such termination for time or expenses actually spent by me at the Company's request on such assistance. I appoint the Secretary of the Company as my attorney-in-fact to execute documents on my behalf for this purpose.

7. **Proprietary Information.** I understand that my employment by the Company creates a relationship of confidence and trust with respect to any information of a confidential or secret nature that may be disclosed to me by the Company or a third party that relates to the business of the company or to the business of any parent, subsidiary, affiliate, customer or supplier of the Company or any other party with whom the Company agrees to hold information of such party in confidence (the "**Proprietary Information**"). Such Proprietary Information includes, but is not limited to, Assigned Inventions, marketing plans, product plans, business strategies, financial information, forecasts, personnel information, customer lists and data, and domain names.

8. **Confidentiality.** At all times, both during my employment and after its termination, I will keep and hold all such Proprietary Information in strict confidence and trust. I will not use or disclose any Proprietary Information without the prior written consent of the Company, except as may be necessary to perform my duties as an employee of the Company for the benefit of the Company. Upon termination of my employment with the Company, I will promptly deliver to the Company all documents and materials of any nature pertaining to my work with the Company and, upon Company request, will execute a document confirming my agreement to honor my responsibilities contained in this Agreement. I will not take with me or retain any documents or materials or copies thereof containing any Proprietary Information.

9. **No Breach of Prior Agreement.** I represent that my performance of all the terms of this Agreement and my duties as an employee of the Company will not breach any invention assignment, proprietary information, confidentiality or similar agreement with any former employer or other party. I represent that I will not bring with me to the Company or use in the performance of my duties for the Company any documents or materials or intangibles of a former employer or third party that are not generally available to the public or have not been legally transferred to the Company.

10. **Efforts; Duty Not to Compete.** I understand that my employment with the Company requires my undivided attention and effort during normal business hours. While I am employed by the Company, I will not, without the Company's express prior written consent, provide services to, or assist in any manner, any business or third party if such services or assistance would be in direct conflict with the Company's business interests.

11. **Notification.** I hereby authorize the Company to notify third parties, including, without limitation, customers and actual or potential employers, of the terms of this Agreement and my responsibilities hereunder.

12. **Non-Solicitation of Employee/Consultants.** During my employment with the Company and for a period of one (1) year thereafter, I will not directly or indirectly solicit away employees or consultants of the Company for my own benefit or for the benefit of any other person or entity.

13. **Non-Solicitation of Suppliers/Customers.** During my employment with the Company and after termination of my employment, I will not directly or indirectly solicit or take away suppliers or customers of the Company if the identity of the supplier or customer or information about the supplier or customer relationship is a trade secret or is otherwise deemed confidential information within the meaning of California law.

14. **Name and Likeness Rights.** I hereby authorize the Company to use, reuse, and to grant others the right to use and reuse, my name, photograph, likeness (including caricature), voice, and biographical information, and any reproduction or simulation thereof, in any form of media or technology now known or hereafter developed (including, but not limited to, film, video and digital or other electronic media), both during and after my employment, for any purposes related to the Company's business, such as marketing, advertising, credits, and presentations.

15. **Injunctive Relief.** I understand that in the event of a breach or threatened breach of this Agreement by me the Company may suffer irreparable harm and will therefore be entitled to injunctive relief to enforce this Agreement.

16. **Governing Law; Severability.** This Agreement will be governed by and construed accordance with the laws of the State of California, without giving effect to its laws pertaining to conflict of laws. If any provision of this Agreement is determined by any court or arbitrator of competent jurisdiction to be invalid, illegal or unenforceable in any respect, such provision will be enforced to the maximum extent possible given the intent of the parties hereto. If such clause or provision cannot be so enforced, such provision shall be stricken from this Agreement and the remainder of this Agreement shall be enforced as if such invalid, illegal or unenforceable clause or provision had (to the extent not enforceable) never been contained in this Agreement.

17. **Counterparts.** This Agreement may be executed in any number of counterparts, each of which when so executed and delivered will be deemed an original and all of which together shall constitute one and the same Agreement.

18. **Entire Agreement.** This Agreement and the documents referred to herein constitute the entire agreement and understanding of the parties with respect to the subject matter of this Agreement, and supersede all prior understanding and agreements, whether oral or written, between or among the parties hereto with respect to the specific subject matter hereof.

19. **Amendment and Waivers.** This Agreement may be amended only by a written agreement executed by each of the parties hereto. No amendment or waiver of, or modification of any obligation under this Agreement will be enforceable unless set forth in a writing signed by the party against which enforcement is sought. Any amendment effected in accordance with this section will be binding upon all parties hereto and each of their respective successors and assigns. No delay or failure to require performance of any provision of this Agreement shall constitute a waiver of that provision as to that or any other instance. No waiver granted under this Agreement as to any one provision herein shall constitute a subsequent waiver of such provision or of any other provision herein, nor shall it constitute the waiver of any performance other than the actual performance specifically waived.

20. **Successors and Assigns; Assignment.** Except as otherwise provided in this Agreement this Agreement, and the rights and obligations of the parties hereunder, will be binding upon and inure to the benefit of their respective successors, assigns, heirs, executors, administrators legal representatives. The Company may assigns any of its rights and obligations under this Agreement. No other party to this Agreement may assign, whether voluntarily or by operation of law, any of its rights and obligations under this Agreement, except with the prior written consent of the Company.

21. **Further Assurances.** The parties agree to execute such further documents and instruments and to take such further actions as may be reasonably necessary to carry out the purpose and intent of this Agreement.

22. **“At Will” Employment.** I understand that this Agreement does not constitute a contract of employment or obligate the Company to employ me for any stated period of time. I understand that I am an “at will” employee of the Company and that my employment can be terminated at any time, with or without notice and with or without cause, for any reason or for no reason, by either the Company or myself. I acknowledge that any statements or representations to the contrary are ineffective, unless put into a writing signed by the Company. I further acknowledge that my participation in any stock option or benefit program is not be construed as any assurance of continuing employment for any particular period of time. This Agreement shall be effective as of the first day of my employment by the Company, which is January 1, 2007.

* * * * *

In Witness Whereof, the parties have executed this Agreement as of the 1st day of January, 2007.

PVI Solutions, Inc.:

Employee:

By: /s/ Raghuveer R. Belur

/s/ Paul Nahi

Signature

Name: Raghuveer R. Belur

Paul Nahi

Name (Please Print)

Title: Member of the Board

Signature Page to Employee Invention Assignment and Confidentiality Agreement

ENPHASE ENERGY, INC.

AMENDMENT NO. 1 TO LETTER AGREEMENT

This Amendment No. 1 (this "Amendment") to the Letter Agreement dated as of January 1, 2007 (the "Agreement") between Enphase Energy, Inc., formerly know as PVI Solutions, Inc. a Delaware corporation with its principal offices located at 201 1st Street, Suite 111, Petaluma, California 94952 (the "Company"), and Paul B. Nahi, a resident of California (the "Employee") is entered into as of December 21, 2008.

WHEREAS, the Company and the Employee have agreed to amend the Agreement to clarify certain existing provisions in light of final regulations issued under Section 409A of the Internal Revenue Code of 1986, as amended.

NOW, THEREFORE, the parties agree as follows:

1. Section 4 of the Agreement is hereby amended and restated as follows:

"4. **Expenses.** You will be reimbursed for reasonable legitimate business expenses incurred in the performance of your duties, provided that such expenses are in accordance with applicable policy set by the Board from time to time and are properly documented and accounted for in accordance with the policy of the Company and with the requirements of the Internal Revenue Service. To the extent that any expense reimbursements are subject to the provisions of Section 409A of the Internal Revenue Code of 1986, as amended (the "**Code**"), such reimbursements will be paid no later than December 31 of the year following the year in which the reimbursable expenses are incurred, the amount of expenses reimbursed in one year will not affect the amount eligible for reimbursement in any subsequent year, and the right to reimbursement will not be subject to liquidation or exchange for another benefit."

2. Section 6(A) of the Agreement is hereby amended and restated as follows:

"(A) In the event that the Company terminates your employment without Cause (as defined below) or you voluntarily resign from your employment with Good Reason (as defined below) and such termination or resignation constitutes a "separation from service" (as defined in Section 409A of the Code): (i) the Company shall pay to you promptly (but in no event more than five (5) days following such termination or resignation), a lump sum equal to (a) your base salary accrued through the date of termination or resignation, (b) all accrued vacation pay and accrued bonuses, if any, to the date of termination or resignation, and (c) an amount equal to three (3) months of your base salary at the higher of (I) the rate in effect on the date of notice of termination or resignation and (II) the rate in effect six months prior to the date of notice of termination or resignation, (ii) the Company shall provide, at the Company's expense, continuation of coverage to you and your dependents under any health plan(s) of the Company adopted after the date of this letter agreement in which you participated on the date of termination or resignation, subject to your timely election of COBRA coverage,

or in the event any such health plan is not continued or you are not eligible for coverage thereunder due to your termination or resignation, the Company shall pay for the premiums for equivalent coverage, in any event, for a period of three (3) months after the date of termination or resignation, and (in) notwithstanding anything to the contrary contained herein or in any agreement with respect hereto: (a) twenty-five percent (25%) of each restricted equity grant, equity option and similar right originally granted to you with respect to securities of the Company, including twenty-five percent (25%) of the stock described in Section 5 above, shall automatically become fully vested and, to the extent of any unexercised right, shall become immediately exercisable; and (b) if such termination or resignation occurs in connection with or following a Change of Control, upon such termination or resignation, **all** of such restricted equity grants, equity options and similar rights held by you with respect to securities of the Company, including the stock grants described in Section 5 above, shall automatically become fully vested and, to the extent of any unexercised right, shall become immediately exercisable. Each unexercised right shall remain exercisable for a period of twelve (12) months following such termination or resignation, provided that you understand that any option that is an Incentive Stock Option under Section 422 of the Internal Revenue Code will become a nonqualified option if the option is not exercised within 90 days following such termination or resignation.”

3. Section 6(D) of the Agreement is hereby amended and restated as follows:

“(D) For purposes of this letter agreement, “Good Reason” means: (i) without your written consent, the assignment of you to any duties materially less than, or any material adverse change in, your duties, responsibilities or authority as President and Chief Executive Officer of the Company, or the removal of you from, or failure to reelect you to, any of such positions, (ii) a material reduction by the Company in your base salary other than a proportionate reduction in the base salaries of all executive officers of the Company, (iii) the Company’s requiring you to be based in excess of 50 miles from the Company’s present executive offices, or (iii) any material breach by the Company of this letter agreement, which shall include a material reduction in the type or level of benefits set forth in Section 3; provided that Good Reason shall not exist unless you provide notice of any condition described in (i)-(vi) above within ninety (90) days of the initial existence of the condition, the Company is provided with a period of thirty (30) days from the date of receipt of such notice to cure the circumstances giving rise to Good Reason and the effective date of your termination following the Company’s failure to cure the circumstances giving rise to Good Reason is not later than thirty (30) days following the expiration of the thirty (30) day cure period.”

4. A new Section 13 of the Agreement is hereby added as follows:

“13. **Compliance with Section 409A.** All severance payments to be made upon a termination of employment under this letter agreement may be made only upon a “separation of service” within the meaning of Section 409A of the Code and the Department of Treasury regulations and other guidance promulgated thereunder. Notwithstanding any provision to the contrary in this letter agreement, if you are deemed

by the Company at the time of your separation from service to be a “specified employee” for purposes of Code Section 409A(a)(2)(B)(i), to the extent delayed commencement of any portion of the benefits to which you are entitled under this letter agreement is required in order to avoid a prohibited distribution under Code Section 409A(a)(2)(B)(i), such portion of your benefits shall not be provided to you prior to the earlier of (i) the expiration of the six-month period measured from the date of your “separation from service” with the Company or (ii) the date of your death. Upon the first business day following the expiration of the applicable Code Section 409A(a)(2)(B)(i) period, all payments deferred pursuant to this Section 13 shall be paid in a lump sum to you, and any remaining payments due under this letter agreement shall be paid as otherwise provided herein. For purposes of Code Section 409A (including, without limitation, for purposes of Treasury Regulation Section 1.409A-2(b)(2)(iii)), your right to receive installment payments under this letter agreement shall be treated as a right to receive a series of separate payments and, accordingly, each installment payment hereunder shall at all times be considered a separate and distinct payment. It is intended that all of the severance payments satisfy, to the greatest extent possible, the exemptions from the application of Code Section 409A provided under of Treasury Regulation 1.409A-1(b)(4), 1.409A-1(b)(5) and 1.409A-1 (b)(9), and this letter agreement will be construed to the greatest extent possible as consistent with those provisions.”

5. Capitalized terms not defined herein have the meanings set forth in the Agreement. Except as set forth herein, the Agreement, as amended hereby, remains in full force and effect.

[Signature Page Follows]

IN WITNESS WHEREOF, the Company and Employee have executed this Amendment as of the date first above written.

“COMPANY”

ENPHASE ENERGY, INC.

By: /s/ Paul Nahi /s/ Jude Radeski

Name: Paul Nahi / Jude Radeski

Title: CEO / CONTROLLER

“EMPLOYEE”

PAUL B. NAHI

By: /s/ Paul Nahi



November 12, 2009

Sanjeev Kumar

Dear Sanjeev:

Enphase Energy, Inc. (the "**Company**") is pleased to offer you employment on the following terms:

1. **Position.** Your title will be Chief Financial Officer, and you will report to Paul Nahi, President and CEO. This is a full-time position. While you render services to the Company, you will not engage in any other employment, consulting or other business activity (whether full-time or part-time) that would create a conflict of interest with your duties to the Company. By signing this letter agreement, you confirm to the Company that you have no contractual commitments or other legal obligations that would prohibit you from performing your duties for the Company.

In connection with your joining the Company, our mutual understanding and agreement is that you will relocate to Northern California by July 2010.

2. **Cash Compensation.** The Company will pay you a starting salary at the rate of Two Hundred Twenty-Five Thousand Dollars (\$225,000) per year, payable in accordance with the Company's standard payroll schedule. Your salary will be subject to adjustment pursuant to the Company's employee compensation policies in effect from time to time. In addition, during your first twelve months of employment, and subject to your continued employment with the Company, you will be eligible to receive a cash bonus of up to Fifty Thousand Dollars (\$50,000) (the "**First Year Bonus**"), based upon completion of objectives to be mutually agreed upon by you and the Company's Chief Executive Officer (the "**First Year MBO's**"). Bonuses in future periods, subject to your continued employment with the Company, are to be mutually agreed upon by you and the Company's Chief Executive Officer. Bonus payment(s) will be paid to you within 60 days following the date that the Company determines that the applicable bonus has been earned. In addition to your salary and bonus, you will be eligible for a reimbursement of up to Fifty-Five Thousand Dollars: (\$55,000) in qualified

relocation expenses (including temporary travel and living expenses) in accordance with the Company's expense reimbursement policies.

3. Potential Loan. At your request, the Company will advance to you as a loan the full amount of the First Year Bonus after completion of your first six months of employment, if the Company determines that you are making reasonable progress toward achieving the First Year MBO's. Such loan will bear interest at the minimum applicable federal rate (AFR) prescribed by the IRS, and will be due and payable on the earlier of March 31, 2011 or the date on which your employment terminates for any reason (the "**Payment Date**") provided that if the Company determines that the First Year MBO's have been fully or partially achieved by the Payment Date, the Company will forgive such loan (including accrued interest) in full or in part (to the extent the First Year MBO's have been achieved) as of the determination date. You will be responsible for all state and federal income and employment taxes associated with the loan and any forgiveness. Notwithstanding the foregoing, in order to comply with Sarbanes-Oxley rules, such loan must be repaid in full (if not forgiven) prior to the initial filing of a registration statement for an initial public offering of the Company's common stock (an "**IPO**").

4. Employee Benefits. As a regular employee of the Company, you will be eligible to participate in regular health insurance, profit sharing, bonus, and other employee benefit plans if and as established by the Company for its employees from time to time. In addition to your gross salary, the Company will make an annual contribution on your behalf to the Company's 401(k) Plan of three percent (3%) of your "compensation", as set forth in the Company's 401(k) Plan, for the preceding 12-month period, subject to the provisions of the Company's 401(k) Plan. The Company may change or cease to make these contributions in future calendar years by providing notice in advance of the beginning of the next plan year. In addition, you will be entitled to paid vacation in accordance with the Company's vacation policy, as in effect from time to time.

5. Expenses. You will be reimbursed for reasonable legitimate business expenses incurred in the performance of your duties in accordance with the Company's expense reimbursement policies, as in effect from time to time.

6. Stock Option Grant. Following execution of this letter agreement, we will recommend to the Board of Directors of the Company that you be granted a stock option to purchase up to Two Million Fifty-Eight

Thousand (2,058,000) shares of Common Stock of the Company under the Company's 2006 Equity Incentive Plan (the "**Plan**"). The exercise price per share will be equal to the fair market value per share on the date the Board approves such grant or on your first day of employment, whichever is later. The stock option will be subject to the terms and conditions applicable to options granted under the Plan, as described in and subject to the Plan and the applicable stock option agreement. Subject to your continued employment and the terms and conditions of the Plan and applicable agreement, twenty-five percent (25%) of the shares will vest and become exercisable twelve (12) months following your first date of employment, and the balance will vest and become exercisable in equal monthly installments over the next thirty-six (36) months of continuous service, as described in the applicable stock option agreement.

With respect to the foregoing, the grant of the opportunity to purchase such shares by the Company is subject to the Board's approval and this promise to recommend such approval is not a promise of compensation and is not intended to create any obligation on the part of the Company.

7. Benefits Upon Termination of Employment Following a Change of Control. In the event of a Change of Control and, following such Change of Control, your employment is terminated by the surviving entity as a result of an involuntary termination other than for Cause or if you resign for Good Reason from the surviving entity in each case at any time within 24 months of your first date of employment with the Company, then you will be entitled to receive severance benefits as follows: (i) severance payments during the period from the date of your termination until the end of the Severance Period (as defined below) equal to the base salary which you were receiving immediately prior to the Change of Control, which payments shall be paid during the Severance Period in accordance with the surviving entity's standard payroll practices, (ii) continuation of the health insurance benefits provided to you for you and your eligible dependents immediately prior to the Change of Control at Company expense pursuant to the terms of the Consolidated Omnibus Budget Reconciliation Act of 1985, as amended ("**COBRA**") or other applicable law through the earlier of the end of the Severance Period or the date upon which you are no longer eligible for such COBRA or other benefits under applicable law, and (iii) your initial stock option grant referenced in Section 6 shall become immediately vested as to 50% of the total number of shares (including shares previously vested). No benefits under this Section 7 will apply after 24 months of your first date of employment with the Company, and the foregoing option

vesting arrangement will only apply to your initial option grant, unless otherwise approved by the Board.

8. **Definition of Terms.** The following terms referred to in this letter agreement shall have the following meanings:

(a) **Change of Control.** “Change of Control” shall mean a sale of all or substantially all of the Company’s assets, or any merger or consolidation of the Company with or into another corporation other than a merger or consolidation in which the holders of more than 50% of the shares of capital stock of the Company outstanding immediately prior to such transaction continue to hold (either by voting securities remaining outstanding or by their being converted into voting securities of the surviving entity) more than 50% of the total voting power represented by the voting securities of the Company, or such surviving entity, outstanding immediately after such transaction. For purposes of clarification, neither an equity financing occurring prior to an IPO nor an IPO will be a Change of Control, even if equity securities representing greater than 50% of the total voting power of the Company are sold in the transaction.

(b) **Cause.** “Cause” shall mean, as determined by the Board of Directors of the Company acting in good faith and based on information then known to it: (A) gross negligence or willful misconduct in the performance of duties to the Company where such gross negligence or willful misconduct has resulted or is likely to result in substantial and material damage to the Company or its subsidiaries; (B) a material failure to comply with the Company’s written policies after having received from the Company notice of, and a reasonable time to cure, such failure; (C) repeated unexplained or unjustified absence from the Company; (D) conviction of a felony or a crime involving moral turpitude causing material harm to the standing and reputation of the Company; (E) unauthorized use or disclosure of any proprietary information or trade secrets of the Company or any other party to whom you owe an obligation of non-disclosure as a result of your relationship with the Company, which use or disclosure causes or is likely to cause material harm to the Company; or (F) your death or Permanent Disability.

(c) **Good Reason.** “Good Reason” for your resignation of your employment will exist following the occurrence of any of the following without your consent: (A) a material reduction or change in job duties, responsibilities or authority inconsistent with your position with the Company and

your prior duties, responsibilities or authority; (B) a reduction of your then current base salary by more than 10 percent (10%) or (C) a relocation of the principal place for performance of your duties to the Company to a location more than twenty-five (25) miles from the Company's then current location; provided that you give written notice to the Company of the event forming the basis of the Good Reason resignation within sixty (60) days of the date the Company gives written notice to you of its affirmative decision to take an action set forth in (A), (B) or (C) above, the Company fails to cure such basis for the Good Reason resignation within thirty (30) days after receipt of your written notice and you terminate employment within one hundred twenty (120) days following the date on which you received notice from the Company of the event forming the basis for the Good Reason resignation.

(d) **Permanent Disability.** "Permanent Disability" shall mean your inability to engage in any substantial gainful activity by reason of any medically determinable physical or mental impairment which can be expected to result in death or which has lasted or can be expected to last for a continuous period of not less than six (6) months.

(e) **Severance Period.** "Severance Period" shall mean (A) nine months in the event your employment termination occurs within eighteen months of your employment start date and (B) six months in the event your employment termination occurs after eighteen months, but within two years, of your employment start date.

9. Parachute Payments. In the event that the acceleration and severance benefits provided for in this Agreement (A) constitute "parachute payments" within the meaning of Section 280G of the Internal Revenue Code of 1986, as amended (the "Code") and (B) but for this paragraph, would be subject to the excise tax imposed by Section 4999 of the Code, then your benefits hereunder shall be payable either: (X) in full, or (Y) as to such lesser amount which would result in no portion of such severance benefits being subject to excise tax under Section 4999 of the Code, whichever of the foregoing amounts, taking into account the applicable federal, state and local income taxes and the excise tax imposed by Section 4999, results in the receipt by you on an after-tax basis, of the greatest amount of benefits hereunder, notwithstanding that all or some portion of such benefits may be taxable under Section 4999 of the Code. Unless the Company and you otherwise agree in writing, any determination required under this paragraph shall be made in writing by the public accountants

designated by the Company (the “Accountants”), whose determination shall be conclusive and binding upon you and the Company for all purposes. For purposes of making the calculations required by this paragraph, the Accountants may make reasonable assumptions and approximations concerning applicable taxes and may rely on reasonable, good faith interpretations concerning the application of Section 280G and 4999 of the Code. The Company and you shall furnish to the Accountants such information and documents as the Accountants may reasonably request in order to make a determination under this paragraph. The Company shall bear all costs the Accountants may reasonably incur in connection with any calculations contemplated by this paragraph. In the event that a reduction in payments and/or benefits is required under this paragraph, such reduction shall occur in the following order: (1) reduction of cash payments; (2) reduction of acceleration of vesting of options and shares; and (3) reduction of other benefits paid to you. If the acceleration of vesting of options and shares is to be reduced, such acceleration of vesting shall be cancelled in the reverse order of the highest price option grant or highest purchase price per share down to the lowest priced option grant or lowest purchase price per share.

10. Limitations and Conditions on Benefits.

(a) **Income and Employment Taxes.** You agree that you shall be responsible for any applicable taxes of any nature (including any penalties or interest that may apply to such taxes) that the Company reasonably determines apply to any payment made hereunder, that your receipt of any benefit hereunder is conditioned on your satisfaction of any applicable withholding or similar obligations that apply to such benefit, and that any cash payment owed hereunder will be reduced to satisfy any such withholding or similar obligations that may apply.

(b) **Code Section 409A.** All payments to be made upon a termination of employment under this Agreement may be made only upon a “separation of service” within the meaning of Section 409A of the Code and the Department of Treasury regulations and other guidance promulgated thereunder (a “Separation from Service”). Notwithstanding any provision of this Agreement to the contrary, if, at the time of your termination of employment with the Company, you are a “specified employee” (as defined in Section 409A of the Code) and the deferral of the commencement of any severance payments or benefits otherwise payable pursuant to this Agreement as a result of such termination of employment is necessary in order to prevent any accelerated or

additional tax under Section 409A of the Code, then the Company will defer the commencement of the payment of any such severance payments or benefits hereunder (without any reduction in such payments or benefits ultimately paid or provided to you) that will not and could not under any circumstances, regardless of when such termination occurs, be paid in full by March 15 of the year following your termination and are in excess of the lesser of (i) two (2) times your then annual compensation or (ii) two (2) times the limit on compensation then set forth in Section 401(a)(17) of the Code and will not be paid by the end of the second calendar year following the year in which the termination occurs, until the first payroll date that occurs after the date that is six (6) months following your “separation of service” with the Company (as defined under Code Section 409A). If any payments are deferred due to such requirements, such amounts will be paid in a lump sum to you on the earliest of (a) your death following the date of your termination of employment with the Company or (ii) the first payroll date that occurs after the date that is six (6) months following your “separation of service” with the Company. For these purposes, each severance payment or benefit is hereby designated as a separate payment or benefit and will not collectively be treated as a single payment or benefit. This paragraph is intended to comply with the requirements of Section 409A of the Code so that none of the severance payments and benefits to be provided hereunder will be subject to the additional tax imposed under Section 409A of the Code and any ambiguities herein will be interpreted to so comply. You and the Company agree to work together in good faith to consider amendments to this Agreement and to take such reasonable actions which are necessary, appropriate or desirable to avoid imposition of any additional tax or income recognition prior to actual payment to you under Section 409A of the Code.

(c) **Release Prior to Receipt of Benefits.** As a condition of receiving the benefits under this Agreement, you shall execute, and allow to become effective, a release of claims agreement (the “Release”) not later than fifty (50) days following your Separation from Service in the form provided by the Company. Such Release shall specifically relate to all of your rights and claims in existence at the time of such execution and shall confirm your obligations under the Company’s standard Employee Invention Assignment and Confidentiality Agreement. Unless the Release is timely executed by you, delivered to the Company, and becomes effective within the required period (the date on which the Release becomes effective, the “Release Date”), you will not receive any of the benefits provided for under this Agreement. In no event will benefits be provided to you until the Release becomes effective. Any lump sum

payment owed to you shall be paid within ten (10) business days following the Release Date, but in no event later than March 15 of the year following the year in which the applicable event occurs.

11. **Confidentiality.** As an employee of the Company, you will have access to certain confidential information of the Company and you may, during the course of your employment, develop certain information or inventions that will be the property of the Company. To protect the interests of the Company, you will need to sign the Company's standard "Employee Invention Assignment and Confidentiality Agreement" attached hereto as Exhibit A as a condition of your employment. We wish to impress upon you that we do not want you to, and we hereby direct you not to, bring with you any confidential or proprietary material of any former employer or to violate any other obligations you may have to any former employer. During the period that you render services to the Company, you agree to not engage in any employment, business or activity that is in any way competitive with the business or proposed business of the Company. You will disclose to the Company in writing any other gainful employment, business or activity that you are currently associated with or participate in that competes with the Company. You will not assist any other person or organization in competing with the Company or in preparing to engage in competition with the business or proposed business of the Company. You represent that your signing of this offer letter, agreement(s) concerning stock options granted to you, if any, under the Plan and the Company's Employee Invention Assignment and Confidentiality Agreement and your commencement of employment with the Company will not violate any agreement currently in place between yourself and current or past employers.

12. **Employment Relationship.** Employment with the Company is for no specific period of time. Your employment with the Company will be "at will," meaning that either you or the Company may terminate your employment at any time and for any reason, with or without cause. Any contrary representations that may have been made to you are superseded by this letter agreement. This is the full and complete agreement between you and the Company on this term. Although your job duties, title, compensation and benefits, as well as the Company's personnel policies and procedures, may change from time to time, the "at will" nature of your employment may only be changed in an express written agreement signed by you and a duly authorized officer of the Company (other than you).

13. **Withholding Taxes.** All forms of compensation referred to in this letter agreement are subject to reduction to reflect applicable withholding and payroll taxes and other deductions required by law.

14. **Interpretation, Amendment and Enforcement.** This letter agreement and Exhibit A constitute the complete agreement between you and the Company, contain all of the terms of your employment with the Company and supersede any prior agreements, representations or understandings (whether written, oral or implied) between you and the Company. This letter agreement may not be amended or modified, except by an express written agreement signed by both you and a duly authorized officer of the Company. The terms of this letter agreement and the resolution of any disputes as to the meaning, effect, performance or validity of this letter agreement or arising out of, related to, or in any way connected with, this letter agreement, your employment with the Company or any other relationship between you and the Company (the "**Disputes**") will be governed by California law, excluding laws relating to conflicts or choice of law. You and the Company submit to the exclusive personal jurisdiction of the federal and state courts located in San Francisco and Sonoma County in connection with any Dispute or any claim related to any Dispute.

* * * * *

We hope that you will accept our offer to join the Company on the terms of this letter. You may indicate your agreement with these terms and accept this offer by signing and dating both the enclosed duplicate original of this letter agreement and the enclosed Proprietary Information and Inventions Agreement and returning them to me. This offer, if not accepted, will expire at the close of business on November 13, 2009. As required by law, your employment with the Company is contingent upon your providing legal proof of your identity and authorization to work in the United States. Your employment is also contingent upon your starting work with the Company on or before December 1, 2009.

Very truly yours,

ENPHASE ENERGY, INC.

By: /s/ Paul Nahi
Paul Nahi

Title: President and CEO

I have read and accept this employment offer:

 /s/ Sanjeev Kumar

Signature of Sanjeev Kumar

Dated: 11/13/09

EXHIBIT A

EMPLOYEE INVENTION ASSIGNMENT AND CONFIDENTIALITY AGREEMENT

In consideration of, and as a condition of my employment with Enphase Energy, Inc., a Delaware corporation (the “*Company*”), I hereby represent to, and agree with the Company as follows:

Purpose of Agreement. I understand that the Company is engaged in a continuous program of research, development, production and marketing in connection with its business and that it is critical for the Company to preserve and protect its Proprietary Information (as defined in Section 7 below), its rights in Inventions (as defined in Section 2 below) and in all related intellectual property rights. Accordingly, I am entering into this Employee Invention Assignment and Confidentiality Agreement (this “*Agreement*”) as a condition of my employment with the Company, whether or not I am expected to create inventions of value for the Company.

Disclosure of Inventions. I will promptly disclose in confidence to the Company all inventions, improvements, designs, original works of authorship, formulas, processes, compositions of matter, computer software programs, databases, mask works, designs and trade secrets that I make or conceive or first reduce to practice or create, either alone or jointly with others, during the period of my employment, whether or not the course of my employment, and whether or not patentable, copyrightable or protectable as trade secrets (the “*Inventions*”).

Inventions Retained and Licensed. I have attached hereto, as Exhibit A, a list describing with particularity all inventions, original works of authorship, improvements, and trade secrets which were made by me prior to the commencement of my employment with the Company (collectively referred to as “*Prior Inventions*”), which belong solely to me or belong to me jointly with another, which relate in any way to any of the Company’s proposed businesses, products or research and development, and which are not assigned to the Company hereunder; or, if no such list is attached, I represent that there are no such Prior Inventions. If, in the course of my employment with the Company, I incorporate into a Company product, process or machine a Prior Invention owned by me or in which I have an interest, the Company is hereby granted and shall have a non-exclusive, royalty-free, irrevocable, perpetual, worldwide license (with the right to sublicense) to make, have made, copy, modify, make derivative

works of, use, sell and otherwise distribute such Prior Invention as part of or in connection with such product, process or machine.

Work for Hire; Assignment of Inventions. I acknowledge and agree that any copyrightable works prepared by me within the scope of my employment are “works for hire” under the Copyright Act and that the Company will be considered the author and owner of such copyrightable works. I agree that all Inventions that (i) are developed using equipment, supplies, facilities or trade secrets of the Company, (ii) result from work performed by me for the Company, or (iii) relate to the Company’s business or current or anticipated research and development (the “**Assigned Inventions**”), will be the sole and exclusive property of the Company and are hereby irrevocably assigned by me to the Company.

Labor Code Section 2870 Notice. I have been notified and understand that the provisions of Sections 3 and 5 of this Agreement do not apply to any Assigned Invention that qualifies fully under the provisions of Section 2870 of the California Labor Code, which states as follows:

ANY PROVISION IN AN EMPLOYMENT AGREEMENT WHICH PROVIDES THAT AN EMPLOYEE SHALL ASSIGN, OR OFFER TO ASSIGN, ANY OF HIS OR HER RIGHTS IN AN INVENTION TO HIS OR HER EMPLOYER SHALL NOT APPLY TO AN INVENTION THAT THE EMPLOYEE DEVELOPED ENTIRELY ON HIS OR HER OWN TIME WITHOUT USING THE EMPLOYER’S EQUIPMENT, SUPPLIES, FACILITIES, OR TRADE SECRET INFORMATION EXCEPT FOR THOSE INVENTIONS THAT EITHER: (1) RELATE AT THE TIME OF CONCEPTION OR REDUCTION TO PRACTICE OF THE INVENTION TO THE EMPLOYER’S BUSINESS, OR ACTUAL OR DEMONSTRABLY ANTICIPATED RESEARCH OR DEVELOPMENT OF THE EMPLOYER; OR (2) RESULT FROM ANY WORK PERFORMED BY THE EMPLOYEE FOR THE EMPLOYER. TO THE EXTENT A PROVISION IN AN

EMPLOYMENT AGREEMENT PURPORTS TO REQUIRE AN EMPLOYEE TO ASSIGN AN INVENTION OTHERWISE EXCLUDED FROM BEING REQUIRED TO BE ASSIGNED UNDER CALIFORNIA LABOR CODE SECTION 2870(a), THE PROVISION IS AGAINST THE PUBLIC POLICY OF THIS STATE AND IS UNENFORCEABLE.

Assignment of Other Rights. In addition to the foregoing assignment of Assigned Inventions to the Company, I hereby irrevocably transfer and assign to the Company: (i) all worldwide patents, patent applications, copyrights, mask works, trade secrets and other intellectual property rights, including but not limited to rights in databases, in any Assigned Inventions, along with any registrations of or applications to register such rights and (ii) any and all “Moral Rights” (as defined below) that I may have in or with respect to any Assigned Inventions. I also hereby forever waive and agree never to assert any and all Moral Rights I may have in or with respect to any Assigned Inventions, even after termination of my work on behalf of the Company “**Moral Rights**” mean any rights to claim authorship of or credit on an Assigned Inventions, to object to or prevent the modification or destruction of any Assigned Inventions, or to withdraw from circulation or control the publication or distribution of any Assigned Inventions, and any similar right, existing under judicial or statutory law of any country or subdivision thereof in the world, or under any treaty, regardless of whether or not such right is denominated or generally referred to as a “moral right.”

Assistance. I agree to assist the Company in every proper way to obtain for the Company and enforce patents, copyrights, mask work rights, trade secret rights and other legal protections for the Company’s Assigned Inventions in any and all countries. I will execute any documents that the Company may reasonably request for use in obtaining or enforcing such patents, copyrights, mask work rights, trade secrets and other legal protections. My obligations under this paragraph will continue beyond the termination of my employment with the Company, provided that the Company will compensate me at a reasonable rate after such termination for time or expenses actually spent by me at the Company’s request on such assistance. I appoint the Secretary of the Company as my attorney-in-fact to execute documents on my behalf for this purpose.

Proprietary Information. I understand that my employment by the Company creates a relationship of confidence and trust with respect to any information of a confidential or secret nature that may be disclosed to me by the Company or a third party that relates to the business of the Company or to the business of any parent, subsidiary, affiliate, customer or supplier of the Company or any other party with whom the Company agrees to hold information of such party in confidence (the “***Proprietary Information***”). Such Proprietary Information includes, but is not limited to, Assigned Inventions, marketing plans, product plans, business strategies, financial information, forecasts, information, customer lists and data, and domain names.

Confidentiality. At all times, both during my employment and after its termination, I will keep and hold all such Proprietary Information in strict confidence and trust. I will not use or disclose any Proprietary Information without the prior written consent of the Company, except as may be necessary to perform my duties as an employee of the Company for the benefit of the Company. Upon termination of my employment with the Company, I will promptly deliver to the Company all documents and materials of any nature pertaining to my work with the Company and, upon Company request, will execute a document confirming my agreement to honor my responsibilities contained in this Agreement. I will not take with me or retain any documents or materials or copies thereof containing any Proprietary Information.

No Breach of Prior Agreement. I represent that my performance of all the terms of this Agreement and my duties as an employee of the Company will not breach any invention assignment, proprietary information, confidentiality or similar agreement with any former employer or other party. I represent that I will not bring with me to the Company or use in the performance of my duties for the Company any documents or materials or intangibles of a former employer or third party that are not generally available to the public or have not been legally transferred to the Company.

Efforts; Duty Not to Compete. I understand that my employment with the Company requires my undivided attention and effort during normal business hours. While I am employed by the Company, I will not, without the Company’s express prior written consent, provide services to, or assist in any manner, any business or third party if such services or assistance would be in direct conflict with the Company’s business interests.

Notification. I hereby authorize the Company to notify third parties, including, without limitation, customers and actual or potential employers, of the terms of this Agreement and my responsibilities hereunder.

Non-Solicitation of Employees/Consultants. During my employment with the Company and for a period of one (1) year thereafter, I will not directly or indirectly solicit away employees or consultants of the Company for my own benefit or for the benefit of any other person or entity.

Non-Solicitation of Suppliers/Customers. During my employment with the Company and after termination of my employment, I will not directly or indirectly solicit or take away suppliers or customers of the Company if the identity of the supplier or customer or information about the supplier or customer relationship is a trade secret or is otherwise deemed confidential information within the meaning of California law.

Name and Likeness Rights. I hereby authorize the Company to use, reuse, and to grant others the right to use and reuse, my name, photograph, likeness (including caricature), voice, and biographical information, and any reproduction or simulation thereof, in any form of media or technology now known or hereafter developed (including, but not limited to, film, video and digital or other electronic media), both during and after my employment, for any purposes related to the Company's business, such as marketing, advertising, credits, and presentations.

Injunctive Relief. I understand that in the event of a breach or threatened breach of this Agreement by me the Company may suffer irreparable harm and will therefore be entitled to injunctive relief to enforce this Agreement.

Governing Law; Severability. This Agreement will be governed by and construed in accordance with the laws of the State of California, without giving effect to its laws pertaining to conflict of laws. If any provision of this Agreement is determined by any court or arbitrator of competent jurisdiction to be invalid, illegal or unenforceable in any respect, such provision will be enforced to the maximum extent possible given the intent of the parties hereto. If such clause or provision cannot be so enforced, such provision shall be stricken from this Agreement and the remainder of this Agreement shall be enforced as if such invalid, illegal or unenforceable clause or provision had (to the extent not enforceable) never been contained in this Agreement.

Counterparts. This Agreement may be executed in any number of counterparts, each of which when so executed and delivered will be deemed an original, and all of which together shall constitute one and the same agreement.

Entire Agreement. This Agreement and the documents referred to herein constitute the entire agreement and understanding of the parties with respect to the subject matter of this Agreement, and supersede all prior understanding and agreements, whether oral or written, between or among the parties hereto with respect to the specific subject matter hereof.

Amendment and Waivers. This Agreement may be amended only by a written agreement executed by each of the parties hereto. No amendment or waiver of, or modification of any obligation under this Agreement will be enforceable unless set forth in a writing signed by the party against which enforcement is sought. Any amendment effected in accordance with this section will be binding upon all parties hereto and each of their respective successors and assigns. No delay or failure to require performance of any provision of this Agreement shall constitute a waiver of that provision as to that or any other instance. No waiver granted under this Agreement as to any one provision herein shall constitute a subsequent waiver of such provision or of any other provision herein, nor shall it constitute the waiver of any performance other than the actual performance specifically waived.

Successors and Assigns; Assignment. Except as otherwise provided in this Agreement, this Agreement, and the rights and obligations of the parties hereunder, will be binding upon and inure to the benefit of their respective successors, assigns, heirs, executors, administrators and legal representatives. The Company may assign any of its rights and obligations under this Agreement. No other party to this Agreement may assign, whether voluntarily or by operation of law, any of its rights and obligations under this Agreement, except with the prior written consent of the Company.

Further Assurances. The parties agree to execute such further documents and instruments and to take such further actions as may be reasonably necessary to carry out the purposes and intent of this Agreement.

“At Will” Employment. I understand that this Agreement does not constitute a contract of employment or obligate the Company to employ me for any stated period of time. I understand that I am an “at will” employee of the

Company and that my employment can be terminated at any time, with or without notice and with or without cause, for any reason or for no reason, by either the Company or myself. I acknowledge that any statements or representations to the contrary are ineffective, unless put into a writing signed by the Company. I further acknowledge that my participation in any stock option or benefit program is not to be construed as any assurance of continuing employment for any particular period of time. This Agreement shall be effective as of the first day of my employment by the Company, which is December 1, 2009.

* * * * *

In Witness Whereof, the parties have executed this Agreement as of the 11/13/09

Enphase Energy, Inc.:

Employee:

By: /s/ Paul Nahi

/s/ Sanjeev Kumar

Name: Paul Nahi

Signature

Title: President and CEO

Sanjeev Kumar

Signature Page to Employee Invention Assignment and Confidentiality Agreement

EXHIBIT A

**LIST OF PRIOR INVENTIONS
AND ORIGINAL WORKS OF AUTHORSHIP**

Title

Date

Identifying Number
or Brief Description

No inventions or improvements

Additional Sheets Attached

Signature of Employee: /s/ Sanjeev Kumar

Print Name of Employee: Sanjeev Kumar

Date: 11/13/09

EMPLOYMENT AGREEMENT

This Employment Agreement (the "**Agreement**") is entered into as of March 21, 2006 (the "**Effective Date**") between PVI Solutions, Inc., a Delaware corporation with its principal offices located at 25 Halsey Avenue, Petaluma, California 94952 (the "**Company**"), and Martin Fornage, a resident of California (the "**Employee**").

In consideration of the promises and the terms and conditions set forth in this Agreement, the parties agree as follows:

1. Position. During the term of this Agreement, Company will employ Employee, and Employee will serve Company in the capacity of Chief Technical Officer and Chief Financial Officer and will be appointed as a member of Company's Board of Directors. Employee will report directly to the Company's Chief Executive Officer.

2. Duties. Employee will perform duties that are executive in nature, consistent with his title; provided, however, that the Company shall not, without Employee's express written consent, require Employee to be based anywhere other than in Sonoma County or Marin County, except for required travel on the Company's business to an extent substantially consistent with travel required of persons who hold similar positions or have similar duties with the Company.

3. Exclusive Service. Employee will devote substantially all his working time and efforts to the business and affairs of the Company. The foregoing shall not, however, preclude Employee (a) from engaging in appropriate civic, charitable or religious activities, (b) from devoting a reasonable amount of time to private investments and business interests, (c) from serving on the boards of directors or advisors of, or as a consultant to, other entities, or (d) from providing incidental assistance to family members on matters of family business, so long as the foregoing activities and service do not conflict with Employee's responsibilities to the Company.

4. Term of Employment.

4.1 Initial Term. The Company agrees to continue Employee's employment, and Employee agrees to remain in the employ of the Company, for a period of five (5) years after the Effective Date unless Employee's employment is earlier terminated pursuant to the provisions of this Agreement.

4.2 Renewal. The term of Employee's employment shall be extended automatically, without further action of either party, as of five (5) years after the Effective Date and on each succeeding anniversary of that date, for terms of one (1) year, unless on or before ninety (90) days prior to the last day of the term of Employee's employment or any extension thereof, the Company or Employee shall notify the other in writing of its intention not to renew Employee's employment, in which case Employee's employment shall terminate at the end of the original term or any extension thereof. If either party notifies the other of its intention not to renew Employee's employment less than ninety (90) days prior to the end of the term of this Agreement or any extension thereof, then such termination shall be effective ninety (90) days from such notice. No notice of non-renewal may be given by either party after a renewal term has commenced. Any such renewal shall be upon such terms and conditions set forth herein,

unless otherwise agreed between the Company and Employee. The notice of non-renewal by either party shall in no way constitute a breach of this Agreement.

4.3 Termination of Agreement. This Agreement shall terminate on the date on which all obligations of the parties hereto have been satisfied.

5. Compensation and Benefits.

5.1 Base Salary. The Company agrees to pay Employee a minimum annual salary of sixty thousand dollars (\$60,000), or in the event of any portion of a year, a pro rata amount of such annual salary. Employee's base salary shall be reviewed by the Board of Directors for possible increases prior to the start of each fiscal year, effective at the beginning of such fiscal year. Employee's salary will be payable as earned in accordance with Company's customary payroll practice.

5.2 Cash Bonus. Employee will be eligible to receive an annual cash bonus in the discretion of the Board of Directors.

5.3 Additional Benefits. Employee will be eligible to participate in Company's employee benefit plans of general application, including without limitation pension and profit-sharing plans, deferred compensation, supplemental retirement or excess-benefit plans, stock option, incentive or other bonus plans, life, health, disability, accident and dental insurance programs, 401(k) plan, paid vacations and sabbatical leave plans, and similar plans or programs, in accordance with the rules established for individual participation in any such plan. Employee shall be entitled each year to four (4) weeks leave for vacation at full pay, provided, that at the end of each year, Employee may accrue and carry over to the next succeeding year a maximum of two (2) weeks of unused vacation. Employee shall also be entitled to reasonable holidays and illness days with full pay in accordance with the Company's policy from time to time in effect.

5.4 Stock Options. Employee will be eligible to receive stock grants and stock option awards in the discretion of the Board of Directors.

5.5 Expenses. The Company will reimburse Employee for all reasonable and necessary expenses incurred by Employee in connection with the Company's business, provided that such expenses are in accordance with applicable policy set by the Board from time to time and are properly documented and accounted for in accordance with the policy of the Company and with the requirements of the Internal Revenue Service.

6. Proprietary Rights. Employee hereby agrees to execute an Employee Invention Assignment and Confidentiality Agreement with the Company in substantially the form attached hereto as Exhibit A.

7. Termination.

7.1 Events of Termination. Employee's employment with the Company shall terminate upon any one of the following:

(a) sixty (60) days after the effective date of a written notice sent to Employee stating the Company's determination made in good faith that it is terminating

Employee for “Cause” as defined under Section 7.2 below (“**Termination for Cause**”), provided, that if the “Cause” for termination is a curable failure by Employee to properly perform his assigned duties, then the Company will give Employee written notice of such failure (a “**Cause Notice**”), and if Employee failure to cure such failure to the reasonable satisfaction of the Board of Directors within sixty (60) days after the Company gives the Cause Notice, then the Company may immediately terminate Employee’s employment, and such termination will be conclusively deemed to be for “cause” hereunder; or

(b) thirty (30) days after the effective date of a written notice sent to Employee stating the Company’s determination made in good faith that, due to a mental or physical incapacity, Employee has been unable to perform his duties under this Agreement for a period of not less than six (6) consecutive months or 180 days in the aggregate in any 12-month period unless Employee has been on a leave approved by the Company’s Board of Directors (“**Termination for Disability**”); or

(c) Employee’s death (“**Termination Upon Death**”); or

(d) the effective date of a written notice sent to the Company stating Employee’s determination made in good faith of “Constructive Termination” by the Company, as defined under Section 7.3 below (“**Constructive Termination**”); or

(e) thirty (30) days after the effective date of a notice sent to Employee stating that the Company is terminating his employment, without cause, which notice can be given by the Company at any time after the Effective Date at the Company’s sole discretion, for any reason or for no reason (“**Termination Without Cause**”); or

(f) the effective date of a notice sent to the Company from Employee stating that Employee is electing to terminate his employment with the Company (“**Voluntary Termination**”),

7.2 “Cause” Defined. For purposes of this Agreement, “cause” for Employee’s termination means Employee’s conviction of a felony involving moral turpitude/will exist at any time after the happening of one or more of the following events:

(a) any willful act or acts of dishonesty undertaken by Employee and intended to result in substantial gain or personal enrichment of Employee at the expense of the Company; or

(b) any willful act of gross misconduct which is materially and demonstrably injurious to the Company.

No act, or failure to act, by Employee shall be considered “willful” if done, or omitted to be done, by him in good faith and in the reasonable belief that his act or omission was in the best interest of the Company and/or required by applicable law.

7.3 “Constructive Termination” Defined. “Constructive Termination” shall mean:

- (a) a material reduction in Employee's salary or benefits not agreed to by Employee; or
- (b) a material change in Employee's responsibilities not agreed to by Employee; or
- (c) the Company's failure to comply in any material respect with any material term of this Agreement; or
- (d) a requirement that Employee relocate to an office that would increase Employee's one-way commute distance by more than forty

(40) miles; or

(e) a "Change in Control" of the Company, as defined herein. A "Change in Control" means the occurrence of any of the following events:

(i) any sale or exchange of the capital stock by the shareholders of the Company in one transaction or series of related transactions where more than 50% of the outstanding voting power of the Company is acquired by a person or entity or group of related persons or entities; or (ii) any reorganization, consolidation or merger of the Company where the outstanding voting securities of the Company immediately before the transaction represent or are converted into less than fifty percent 50% of the outstanding voting power of the surviving entity (or its parent corporation) immediately after the transaction; or (iii) the consummation of any transaction or series of related transactions that results in the sale of all or substantially all of the assets of the Company; or (iv) any "person" or "group" (as defined in the Securities Exchange Act of 1934, as amended (the "*Exchange Act*")) becoming the "beneficial owner" (as defined in Rule 13d-3 under the Exchange Act) directly or indirectly of securities representing more than fifty percent (50%) of the voting power of the Company then outstanding; or (v) less than a majority of the Board of Directors are persons who were either nominated for election by the Board of Directors or were elected by the Board of Directors.

8. Effect of Termination.

8.1 Termination for Cause or Voluntary Termination. In the event of any termination of Employee's employment pursuant to Section 7.1(a) or Section 7.1(f), the Company shall immediately pay to Employee the compensation and benefits otherwise payable to Employee under Section 5 through the date of termination. Employee's rights under the Company's benefit plans of general application shall be determined under the provisions of those plans.

8.2 Termination for Disability. In the event of termination of employment pursuant to Section 7.1(b):

(a) the Company shall immediately pay to Employee the compensation and benefits otherwise payable to Employee under Section 5 through the date of termination,

(b) for six (6) months after the termination of Employee's employment, the Company shall continue to pay Employee (A) his salary under Section 5.1 above at Employee's then-current salary, less applicable withholding taxes, payable on the Company's normal payroll dates during that period, (B) his annual cash bonus, if any, under Section 5.2 above, and (C) shall continue his benefits under Section 5.3 above, and

(c) Employee shall receive other severance and disability payments as provided in the Company's standard benefit plans.

If Employee's employment is terminated pursuant to Section 7.1(b) and Employee resumes the performance of substantially all of his duties hereunder before five (5) years after the Effective Date, Employee may notify the Company that Employee is choosing to reinstate this Agreement as though it had never been terminated. Within thirty (30) days of the Effective Date, the Company will procure disability insurance sufficient to fund its obligations to Employee hereunder, naming the Employee as payee. The Company shall maintain such insurance in force at all times that Employee is employed pursuant to this Agreement.

8.3 Termination Upon Death. In the event of termination of employment pursuant to Section 7.1(c), all obligations of the Company and Employee shall cease, except the Company shall immediately pay to Employee (or to Employee's estate) the compensation and benefits otherwise payable to Employee under Section 5 through the date of termination.

8.4 Constructive Termination or Termination Without Cause. In the event of any termination of this Agreement pursuant to Section 7.1(d) or Section 7.1(e),

(a) the Company shall immediately pay to Employee the compensation and benefits otherwise payable to Employee under Section 5 through the date of termination, and

(b) for the longer of (i) six (6) months after the termination of Employee's employment, or (ii) five (5) years after the Effective Date, the Company shall continue to pay Employee (A) his salary under Section 5.1 above at Employee's then-current salary, less applicable withholding taxes, payable on the Company's normal payroll dates during that period, (B) his annual cash bonus, if any, under Section 5.2 above, and (C) shall continue his benefits under Section 5.3 above, and

(c) all of Employee's options to purchase the Company's Common Stock shall, as of the date of employment termination, be immediately exercisable in full and shall remain exercisable for the periods specified in such options or the plans governing such options, and all shares of the Company's Common Stock owned by Employee shall immediately be released from any and all vesting restrictions; provided, that if the total amount of the benefits available to Employee under this Section 8.4, either alone or together with other payments which Employee has the right to receive from the Company, would constitute a "parachute payment" as defined in Section 280G of the Internal Revenue Code of 1986, as amended (the "Code"), then Employee may elect to either (i) receive such payments in full; or (ii) reduce the total amount of such benefits to the largest amount that would result in no portion of such benefits being subject to the excise tax imposed by Section 4999 of the Code. The determination of any reduction in the benefits available under this Section 8.4 pursuant to the foregoing shall be made by the Company in good faith and any such reduction shall reduce first the cash payable under this Section 8.4, then the acceleration of options, then the vesting of stock.

9. Miscellaneous.

9.1 Arbitration. Employee and Company shall submit to mandatory and exclusive binding arbitration of any controversy or claim arising out of, or relating to, this Agreement or any breach hereof, provided, however, that the parties retain their right to, and shall not be prohibited, limited or in any other way restricted from, seeking or obtaining equitable relief from a court having jurisdiction over the parties. Such arbitration shall be governed by the Federal Arbitration Act and conducted through the American Arbitration Association in the State of California, San Francisco County, before a single neutral arbitrator, in accordance with the National Rules for the Resolution of Employment Disputes of the American Arbitration Association in effect at that time. The parties may conduct only essential discovery prior to the hearing, as defined by the AAA arbitrator. The arbitrator shall issue a written decision which contains the essential findings and conclusions on which the decision is based. The Employee shall bear only those costs of arbitration he or she would otherwise bear had he or she brought a claim covered by this Agreement in court. Judgment upon the determination or award rendered by the arbitrator may be entered in any court having jurisdiction thereof.

9.2 Severability. If any provision of this Agreement shall be found by any arbitrator or court of competent jurisdiction to be invalid or unenforceable, then the parties hereby waive such provision to the extent that it is found to be invalid or unenforceable and to the extent that to do so would not deprive one of the parties of the substantial benefit of its bargain. Such provision shall, to the extent allowable by law and the preceding sentence, be modified by such arbitrator or court so that it becomes enforceable and, as modified, shall be enforced as any other provision hereof, all the other provisions continuing in full force and effect.

9.3 No Waiver. The failure by either party at any time to require performance or compliance by the other of any of its obligations or agreements shall in no way affect the right to require such performance or compliance at any time thereafter. The waiver by either party of a breach of any provision hereof shall not be taken or held to be a waiver of any preceding or succeeding breach of such provision or as a waiver of the provision itself. No waiver of any kind shall be effective or binding, unless it is in writing and is signed by the party against whom such waiver is sought to be enforced.

9.4 Assignment. This Agreement and all rights hereunder are personal to Employee and may not be transferred or assigned by Employee at any time. The Company may assign its rights, together with its obligations hereunder, to any parent, subsidiary, affiliate or successor, or in connection with any sale, transfer or other disposition of all or substantially all of its business and assets, provided, however, that any such assignee assumes the Company's obligations hereunder.

9.5 Withholding. All sums payable to Employee hereunder shall be reduced by all federal, state, local and other withholding and similar taxes and payments required by applicable law.

9.6 Entire Agreement. This Agreement (and the exhibit(s) hereto) constitutes the entire and only agreement and understanding between the parties relating to employment of Employee with Company and this Agreement supersedes and cancels any and all previous contracts, arrangements or understandings with respect to Employee's employment;

except that the Employee Invention Assignment and Confidentiality Agreement shall remain as an independent contract and shall remain in full force and effect according to its terms.

9.7 Amendment. This Agreement may be amended, modified, superseded, cancelled, renewed or extended only by an agreement in writing executed by both parties hereto.

9.8 Notices. All notices and other communications required or permitted under this Agreement shall be in writing and hand delivered, sent by telecopier, sent by registered first class mail, postage pre-paid, or sent by nationally recognized express courier service. Such notices and other communications shall be effective upon receipt if hand delivered or sent by telecopier, five (5) days after mailing if sent by mail, and one (1) day after dispatch if sent by express courier, to the following addresses, or such other addresses as any party shall notify the other parties:

If to the Company:	<u>PVI Solutions, Inc.</u> <u>25 Halsey Avenue</u> <u>Petaluma, CA 94952</u>
Telecopier:	<u>—</u>
Attention:	<u>President</u>
If to Employee:	<u>Martin Fornage</u> <u>25 Halsey Avenue</u> <u>Petaluma, CA 94952</u>
Telecopier:	<u>—</u>
Attention:	<u>—</u>

9.9 Binding Nature. This Agreement shall be binding upon, and inure to the benefit of, the successors and personal representatives of the respective parties hereto.

9.10 Headings. The headings contained in this Agreement are for reference purposes only and shall in no way affect the meaning or interpretation of this Agreement. In this Agreement, the singular includes the plural, the plural included the singular, the masculine gender includes both male and female referents, and the word “or” is used in the inclusive sense.

9.11 Counterparts. This Agreement may be executed in two or more counterparts, each of which shall be deemed to be an original but all of which, taken together, constitute one and the same agreement.

9.12 Governing Law. This Agreement and the rights and obligations of the parties hereto shall be construed in accordance with the laws of the State of Delaware, without giving effect to the principles of conflict of laws.

9.13 Attorneys’ Fees. In the event of any claim, demand or suit arising out of or with respect to this Agreement, the prevailing party shall be entitled to reasonable costs and attorneys’ fees, including any such costs and fees upon appeal.

IN WITNESS WHEREOF, the Company and Employee have executed this Agreement as of the date first above written.

“COMPANY”

“EMPLOYEE”

 /s/ Raghu Belur

 /s/ Martin Fornage

By: Raghu Belur

By: Martin Fornage

President / CEO

Signature Page to Employment Agreement

**EMPLOYEE INVENTION ASSIGNMENT AND
CONFIDENTIALITY AGREEMENT**

In consideration of, and as a condition of my employment with PVI Solutions, Inc., a Delaware corporation (the “*Company*”), I hereby represent to, and agree with the Company as follows:

1. Purpose of Agreement. I understand that the Company is engaged in a continuous program of research, development, production and marketing in connection with its business and that it is critical for the Company to preserve and protect its “*Proprietary Information*” (as defined in Section 7 below), its rights in “*Inventions*” (as defined in Section 2 below) and in all related intellectual property rights. Accordingly, I am entering into this Employee Invention Assignment and Confidentiality Agreement (this “*Agreement*”) as a condition of my employment with the Company, whether or not I am expected to create inventions of value for the Company.

2. Disclosure of Inventions. I will promptly disclose in confidence to the Company all inventions, improvements, designs, original works of authorship, formulas, processes, compositions of matter, computer software programs, databases mask works, designs and trade secrets that I make or conceive or first reduce to practice or create either alone or Jointly with others, during the period of my employment, whether or not in the course of my employment, and whether or not patentable, copyrightable or protectable as trade secrets (the “*Inventions*”).

3. Work for Hire; Assignment of Inventions. I acknowledge and agree that any copyrightable works prepared by me within the scope of my employment are “works for hire” under the Copyright Act and that the Company will be considered the author and owner of such copyrightable works. I agree that all Inventions that (i) are developed using equipment, supplies, facilities or trade secrets of the Company, (ii) result from work performed by me for the Company, or (iii) relate to the Company’s business or current or anticipated research and development (the “*Assigned Inventions*”), will be the sole and exclusive property of the Company and are hereby irrevocably assigned by me to the Company.

4. Labor Code Section 2870 Notice. I have been notified and understand that the provisions of Sections 3 and 5 of this Agreement do not apply to any Assigned Invention that qualifies fully under the provisions of Section 2870 of the California Labor Code, which states as follows:

ANY PROVISION IN AN EMPLOYMENT AGREEMENT WHICH PROVIDES THAT AN EMPLOYEE SHALL ASSIGN, OR OFFER TO ASSIGN, ANY OF HIS OR HER RIGHTS IN AN INVENTION TO HIS OR HER EMPLOYER SHALL NOT APPLY TO AN INVENTION THAT THE EMPLOYEE DEVELOPED ENTIRELY ON HIS OR HER OWN TIME WITHOUT USING THE EMPLOYER’S EQUIPMENT, SUPPLIES, FACILITIES, OR TRADE SECRET INFORMATION EXCEPT FOR THOSE INVENTIONS THAT

EITHER: (1) RELATE AT THE TIME OF CONCEPTION OR REDUCTION TO PRACTICE OF THE INVENTION TO THE EMPLOYER'S BUSINESS, OR ACTUAL OR DEMONSTRABLY ANTICIPATED RESEARCH OR DEVELOPMENT OF THE EMPLOYER; OR (2) RESULT FROM ANY WORK PERFORMED BY THE EMPLOYEE FOR THE EMPLOYER. TO THE EXTENT A PROVISION IN AN EMPLOYMENT AGREEMENT PURPORTS TO REQUIRE AN EMPLOYEE TO ASSIGN AN INVENTION OTHERWISE EXCLUDED FROM BEING REQUIRED TO BE ASSIGNED UNDER CALIFORNIA LABOR CODE SECTION 2870(a), THE PROVISION IS AGAINST THE PUBLIC POLICY OF THIS STATE AND IS UNENFORCEABLE.

5. Assignment of Other Rights. In addition to the foregoing assignment of Assigned Inventions to the Company, I hereby irrevocably transfer and assign to the Company: (i) all worldwide patents, patent applications, copyrights, mask works; trade secrets and other intellectual property rights, including but not limited to rights in databases, in any Assigned Inventions, along with any registrations of or applications to register such rights; and (ii) any and all "Moral Rights" (as defined below) that I may have in or with respect to any Assigned Inventions. I also hereby forever waive and agree never to assert any and all Moral Rights I may have in or with respect to any Assigned Inventions, even after termination of my work on behalf of the Company. "**Moral Rights**" mean any rights to claim authorship of or credit on an Assigned Inventions, to object to or prevent the modification or destruction of any Assigned Inventions, or to withdraw from, circulation or control the publication or distribution of any Assigned Inventions, and any similar right, existing under judicial or statutory law of any country of subdivision thereof in the world, or under any treaty, regardless of whether or not such right is denominated or generally referred to as a "moral right."

6. Assistance. I agree to assist the Company in every proper way to obtain for the Company and enforce patents, copyrights, mask work rights, trade secret rights and other legal protections for the Company's Assigned Inventions in any and all countries. I will execute any documents that the Company may reasonably request for use in obtaining or enforcing such patents, copyrights, mask work rights, trade secrets and other legal protections. My obligations under this paragraph will continue beyond the termination of my employment with the Company, provided that the Company will compensate me at a reasonable rate after such termination for time or expenses actually spent by me at the Company's request on such assistance. I appoint the Secretary of the Company as my attorney-in-fact to execute documents on my behalf for this purpose.

7. Proprietary Information. I understand that my employment by the Company creates a relationship of confidence and trust with respect to any information of a confidential or secret nature that may be disclosed to me by the Company or a third party that relates to the business of the Company or to the business of any parent, subsidiary, affiliate, customer or supplier of the Company or any other party with whom the Company agrees to hold information of such party in confidence (the "**Proprietary Information**"). Such Proprietary Information includes, but is not limited to, Assigned Inventions, marketing plans, product plans, business

strategies, financial information, forecasts, personnel information, customer lists and data, and domain names.

8. Confidentiality. At all times, both during my employment and after its termination, I will keep and hold all such Proprietary Information in strict confidence and trust. I will not use or disclose any Proprietary Information without the prior written consent of the Company, except as may be necessary to perform my duties as an employee of the Company for the benefit of the Company. Upon termination of my employment with the Company, I will promptly deliver to the Company all documents and materials of any nature pertaining to my work with the Company and, upon Company request, will execute a document confirming my agreement to honor my responsibilities contained in this Agreement. I will not take with me or retain any documents or materials or copies thereof containing any Proprietary Information.

9. No Breach of Prior Agreement. I represent that my performance of all the terms of this Agreement and my duties as an employee of the Company will not breach any Invention assignment, proprietary information, confidentiality or similar agreement with any former employer or other party. I represent that I will not bring with me to the Company or use in the performance of my duties for the Company any documents or materials or intangibles of a former employer or third party that are not generally available to the public or have not been legally transferred to the Company.

10. Efforts; Duty Not to Compete. I understand that my employment with the Company requires my undivided attention and effort during normal business hours. While I am employed by the Company, I will not, without the Company's express prior written consent, provide services to, or assist in any manner, any business or third party if such services or assistance would be in direct conflict with the Company's business interests.

11. Notification. I hereby authorize the Company to notify third parties, including, without limitation, customers and actual or potential employers, of the terms of this Agreement and my responsibilities hereunder.

12. Non-Solicitation of Employees/Consultants. During my employment with the Company and for a period of one (1) year thereafter, I will not directly or indirectly solicit away employees or consultants of the Company for my own benefit or for the benefit of any other person or entity.

13. Non-Solicitation of Suppliers/Customers. During my employment with the Company and after termination of my employment, I will not directly or indirectly solicit or take away suppliers or customers of the Company if the identity of the supplier or customer or information about the supplier or customer relationship is a trade secret or is otherwise deemed confidential information within the meaning of California law.

14. Name and Likeness Rights. I hereby authorize the Company to use, reuse, and to grant others the right to use and reuse, my name, photograph, likeness (including caricature), voice, and biographical information, and any reproduction or simulation thereof, in any form of media or technology now known or hereafter developed (including, but not limited to, film, video and digital or other electronic media), both during and after my employment, for any

purposes related to the Company's business, such as marketing, advertising, credits, and presentations.

15. Injunctive Relief. I understand that in the event of a breach or threatened breach of this Agreement by me the Company may suffer irreparable harm and will therefore be entitled to injunctive relief to enforce this Agreement.

16. Governing Law; Severability. This Agreement will be governed by and construed in accordance with the laws of the State of California, without giving effect to its laws pertaining to conflict of laws. If any provision of this Agreement is determined by any court or arbitrator of competent jurisdiction to be invalid, illegal or unenforceable in any respect such provision will be enforced to the maximum extent possible given the intent of the parties hereto. If such clause or provision cannot be so enforced, such provision shall be stricken from this Agreement and the remainder of this Agreement shall be enforced as if such invalid, illegal or unenforceable clause or provision had (to the extent not enforceable) never been contained in this Agreement.

17. Counterparts. This Agreement may be executed in any number of counterparts, each of which when so executed and delivered will be deemed an original, and all of which together shall constitute one and the same agreement.

18. Entire Agreement. This Agreement and the documents referred to herein constitute the entire agreement and understanding of the parties with respect to the subject matter of this Agreement, and supersede all prior understandings and agreements, whether oral or written, between or among the parties hereto with respect to the specific subject matter hereof.

19. Amendment and Waivers. This Agreement may be amended only by a written agreement executed by each of the parties hereto. No amendment or waiver of, or modification of any obligation under this Agreement will be enforceable unless set forth in a writing signed by the party against which enforcement is sought. Any amendment effected in accordance with this section will be binding upon all parties hereto and each of their respective successors and assigns. No delay or failure to require performance of any provision of this Agreement shall constitute a waiver of that provision as to that or any other instance. No waiver of such provision or of any other provision herein, nor shall it constitute the waiver of any performance other than the actual performance specifically waived.

20. Successors and Assigns; Assignment. Except as otherwise provided in this Agreement, this Agreement, and the rights and obligations of the parties hereunder, will be binding upon and inure to the benefit of their respective successors, assigns, heirs, executors, administrators and legal representatives. The Company may assign any of its rights and obligations under this Agreement. No other party to this Agreement may assign, whether voluntarily or by operation of law, any of its rights and obligations under this Agreement, except with the prior written consent of the Company.

21. Further Assurances. The parties agree to execute such further documents and instruments and to take such further actions as may be reasonably necessary to carry out the purposes and intent of this Agreement.

22. "At Will" Employment. I understand that this Agreement does not constitute a contract of employment or obligate the Company to employ me for any stated period of time. I understand that I am an "at will" employee of the Company and that my employment can be terminated at any time, with or without notice and with or without cause, for any reason or for no reason, by either the Company or myself. I acknowledge that any statements or representations to the contrary are ineffective, unless put into a writing signed by the Company. I further acknowledge that my participation in any stock option or benefit program is not to be construed as any assurance of continuing employment for any particular period of time. This Agreement shall be effective as of the first day of my employment by the Company, which is March 21, 2006.

* * * * *

In Witness Whereof, the parties have executed this Agreement as of the 21st day of March, 2006.

PVI Solutions, Inc.:

By: /s/ Raghuvveer Belur

Name: Raghuvveer Belur

Title: President and CEO

Employee:

/s/ Martin Fornage
Signature

Martin Fornage
Name (Please Print)

Signature Page to Employee Invention Assignment and Confidentiality Agreement

AMENDMENT TO EMPLOYMENT AGREEMENT

This Amendment (this "**Amendment**") to that certain Employment Agreement dated as of March 21, 2006 (the "**Agreement**") between PVI Solutions, Inc., a Delaware corporation with its principal offices located at 101 2nd Street, Suite 110, Petaluma, CA 94952 (the "**Company**"), and Martin Fornage, a resident of California (the "**Employee**") is entered into as of January 23, 2007.

WHEREAS, pursuant to the Agreement, Employee has served the Company in the capacity of Chief Technical Officer and Chief Financial Officer and a member of the Company's Board of Directors.

WHEREAS, in connection with the Series B Preferred Stock financing of the Company, Employee has agreed to serve as the Company's Chief Technical Officer and to cease serving as the Company's Chief Financial Officer and as a member of the Company's Board of Directors.

WHEREAS, the Company has determined that it is in the best interests of the Company to change Employee's base salary, effective upon the receipt of minimum aggregate gross proceeds to the Company of Four Million Dollars (\$4,000,000) in connection with a Series B Preferred Stock offering (the "**Series B Date**").

NOW, THEREFORE, the parties agree as follows:

1. Section 1 of the Agreement is hereby amended and restated as follows:

"Position. During the term of this Agreement, Company will employ Employee, and Employee will serve Company in the capacity of Chief Technical Officer. Employee will report directly to the Company's Chief Executive Officer."

The parties acknowledge and agree that the change in Employee's position effected by this Amendment shall not constitute a Constructive Termination or Termination without Cause under the Agreement

2. Section 5.1 of the Agreement is hereby amended and restated as follows as of the Series B Date:

"Base Salary. The Company agrees to pay Employee a minimum annual salary of one hundred and forty thousand dollars (\$140,000), or in the event of any portion of a year, a pro rata amount of such annual salary. Employee's base salary shall be reviewed by the Board of Directors for possible increases prior to the start of each fiscal year, effective at the beginning of such fiscal year. Employee's salary will be payable as earned in accordance with Company's customary payroll practice."

3. Capitalized terms not defined herein have the meanings set forth in the Agreement. Except as set forth herein, the Agreement, as amended hereby, remains in full force and effect.

IN WITNESS WHEREOF, the Company and Employee have executed this Amendment as of the date first above written.

“COMPANY”

“EMPLOYEE”

/s/ Paul Nahi

/s/ Martin Fornage

By: Paul Nahi

By: Martin Fornage

Signature Page to Employment Agreement

ENPHASE ENERGY, INC.

AMENDMENT NO. 2 TO EMPLOYMENT AGREEMENT

This Amendment No. 2 (this "Amendment") to that certain Employment Agreement dated as of March 21, 2006, as amended on January 23, 2007 (as amended, the "Agreement") between Enphase Energy, Inc., formerly known as PVI Solutions, Inc., a Delaware corporation with its principal offices located at 201 1st Street, Suite 111, Petaluma, California 94952 (the "Company"), and Martin Fornage, a resident of California (the "Employee") is entered into as of April 16, 2008.

WHEREAS, in connection with the Series C Preferred Stock financing of the Company, Employee has agreed to a change in the terms of his severance compensation.

NOW, THEREFORE, the parties agree as follows:

1. Section 8.4(b) of the Agreement is hereby amended and restated as follows:

"(b) for six (6) months after the termination of Employee's employment the Company shall continue to pay Employee (A) his salary under Section 5.1 at Employee's then-current salary, less applicable withholding taxes, payable on the Company's normal payroll dates during that period, (B) his annual cash bonus, if any, under Section 5.2 above, and (C) shall continue his benefits under Section 5.3 above, and"

2. Capitalized terms not defined herein have the meanings set forth in the Agreement. Except as set forth herein, the Agreement, as amended hereby, remains in full force and effect.

[Signature Page Follows]

IN WITNESS WHEREOF, the Company and Employee have executed this Amendment as of the date first above written.

“COMPANY”

“EMPLOYEE”

ENPHASE ENERGY, INC.

MARTIN FORNAGE

By: /s/ Paul Nahi

By: /s/ Martin Fornage

Name Paul Nahi
Title: President & CEO

SIGNATURE PAGE TO AMENDMENT NO. 2 TO EMPLOYMENT AGREEMENT

ENPHASE ENERGY, INC.

AMENDMENT NO. 3 TO EMPLOYMENT AGREEMENT

This Amendment No. 3 (this "Amendment") to that certain Employment Agreement dated as of March 21, 2006, as amended on January 23, 2007 and April 16, 2008 (as amended, the "Agreement") between Enphase Energy, Inc. formerly know as PVI Solutions, Inc. a Delaware corporation with its principal offices located at 201 1st Street, Suite 111, Petaluma, California 94952 (the "Company"), and Martin Fomage, a resident of California (the "Employee") is entered into as of December 21, 2008.

WHEREAS, the Company and the Employee have agreed to amend the Agreement to clarify certain existing provisions in light of final regulations issued under Section 409A of the Internal Revenue Code of 1986, as amended.

NOW, THEREFORE, the parties agree as follows:

1. Section 5.2 of the Agreement is hereby amended and restated as follows:

"**5.2 Cash Bonus.** Employee will be eligible to receive an annual cash bonus in the discretion of the Board of Directors. A bonus will not be earned unless and until the Board of Directors makes such determination. If the Board of Directors determines that Employee will receive an annual bonus, the bonus will be paid to Employee within 60 days following the date of the Board of Directors' determination."

2. Section 5.5 of the Agreement is hereby amended and restated as follows:

"**5.5. Expenses.** The Company will reimburse Employee for all reasonable and necessary expenses incurred by Employee in connection with the Company's business, provided that such expenses are in accordance with applicable policy set by the Board from time to time and are properly documented and accounted for in accordance with the policy of the Company and with the requirements of the Internal Revenue Service. To the extent that any expense reimbursements are subject to the provisions of Section 409A of the Internal Revenue Code of 1986, as amended (the "**Code**"), such reimbursements will be paid no later than December 31 of the year following the year in which the reimbursable expenses are incurred, the amount of expenses reimbursed in one year will not affect the amount eligible for reimbursement in any subsequent year, and the right to reimbursement will not be subject to liquidation or exchange for another benefit."

3. Section 7.1 (d) of the Agreement is hereby amended and restated as follows:

"(d) thirty (30) days following the date of a written notice sent to the Company by Employee stating the circumstances giving rise to a "Constructive Termination," as defined under Section 7.3 below ("**Constructive Termination**"); provided that such notice is delivered to the Company within ninety (90) days of the initial existence of the circumstances giving rise to a Constructive Termination and the Company is provided

with an opportunity to cure the circumstances giving rise to a Constructive Termination within the thirty (30) day notice period and fails to do so.”

4. Section 7.3(a) of the Agreement is hereby amended and restated as follows:

“(a) a material reduction in Employee’s salary not agreed to by Employee; or”

5. Section 7.3(c) of the Agreement is hereby amended and restated as follows:

“(c) the Company’s failure to comply in any material respect with any material term of this Agreement, which shall include a material reduction in the type or level of benefits set forth in Section 5.3, not agreed to by Employee; or”

6. The first sentence of Section 8.2 of the Agreement is hereby amended and restated as follows:

“**8.2 Termination for Disability.** In the event of termination of employment pursuant to Section 7.1(b) and provided that such termination constitutes a “separation from service” (as such term is defined in Section 409A of the Code):”

7. Section 8.2(b) of the Agreement is hereby amended and restated as follows:

“(b) for six (6) months after the termination of Employee’s employment, the Company shall continue to pay (A) Employee’s salary under Section 5.1 above at Employee’s then current salary, less applicable withholding taxes, payable on the Company’s normal payroll dates during that period, (B) Employee’s annual cash bonus, under Section 5.2 above, and (C) the premiums for Employee’s continued medical and any other applicable health insurance coverage under COBRA subject to Employee’s timely election of COBRA coverage. Employee’s continued eligibility for participation and subject to COBRA’s terms, conditions and restrictions; and”

8. The first sentence of Section 8.4 of the Agreement is hereby amended and restated as follows:

“**8.4 Constructive Termination or Termination Without Cause.** In the event of any termination of this Agreement pursuant to Section 7.1(d) or Section 7.1(e) and provided that such termination constitutes a “separation from service” (as defined in Section 409A of the Code),”

9. Section 8.4(b) of the Agreement is hereby amended and restated as follows:

“(b) for six (6) months after the termination of Employee’s employment, the Company shall continue to pay (A) Employee’s salary under Section 5.1 above at Employee’s then current salary, less applicable withholding taxes, payable on the Company’s normal payroll dates during that period, (B) Employee’s annual cash bonus, under Section 5.2 above, and (C) the premiums for Employee’s continued medical and

any other applicable health insurance coverage under COBRA subject to Employee's timely election of COBRA coverage. Employee's continued eligibility for participation and subject to COBRA's terms, conditions and restrictions; and"

10. A new Section 9.14 of the Agreement is hereby added as follows:

"9.14 Compliance with Section 409A. All severance payments to be made upon a termination of employment under this Agreement may be made only upon a "separation of service" within the meaning of Section 409A of the Code and the Department of Treasury regulations and other guidance promulgated thereunder. Notwithstanding any provision to the contrary in this Agreement, if Employee is deemed by the Company at the time of Employee's separation from service to be a "specified employee" for purposes of Code Section 409A(a)(2)(B)(i), to the extent delayed commencement of any portion of the benefits to which Employee is entitled under this Agreement is required in order to avoid a prohibited distribution under Code Section 409A(a)(2)(B)(i), such portion of Employee's benefits shall not be provided to Employee prior to the earlier of (i) the expiration of the six-month period measured from the date of Employee's "separation from service" with the Company or (ii) the date of Employee's death. Upon the first business day following the expiration of the applicable Code Section 409A(a)(2)(B)(i) period, all payments deferred pursuant to this Section 9.14 shall be paid in a lump sum to Employee, and any remaining payments due under the Agreement shall be paid as otherwise provided herein. For purposes of Code Section 409A (including, without limitation, for purposes of Treasury Regulation Section 1.409A-2(b)(2)(iii)), Employee's right to receive installment payments under this Agreement shall be treated as a right to receive a series of separate payments and, accordingly, each installment payment hereunder shall at all times be considered a separate and distinct payment. It is intended that all of the severance payments satisfy, to the greatest extent possible, the exemptions from the application of Code Section 409A provided under of Treasury Regulation 1.409A-1(b)(4), 1.409A-1(b)(5) and 1.409A-1(b)(9), and this Agreement will be construed to the greatest extent possible as consistent with those provisions."

11. Capitalized terms not defined herein have the meanings set forth in the Agreement. Except as set forth herein, the Agreement, as amended hereby, remains in full force and effect.

[Signature Page Follows]

IN WITNESS WHEREOF, the Company and Employee have executed this Amendment as of the date first above written.

“COMPANY”

“EMPLOYEE”

ENPHASE ENERGY, INC.

MARTIN FORNAGE

By: /s/ Paul Nahi

By: /s/ Martin Fornage

Name: Paul Nahi - CEO

Title: CEO



April 19, 2010

Jeff Loebbaka
Los Gatos, California

Dear Jeff:

Enphase Energy, Inc. (the "**Company**") is pleased to offer you employment on the following terms:

1. **Position.** Your title will be Vice President, Worldwide Sales, and you will report to Paul Nahi, President and CEO. This is a full-time position. While you render services to the Company, you will not engage in any other employment, consulting or other business activity (whether full-time or part-time) that would create a conflict of interest with your duties to the Company. By signing this letter agreement, you confirm to the Company that you have no contractual commitments or other legal obligations that would prohibit you from performing your duties for the Company.

In connection with your joining the Company, our mutual understanding and agreement is that you will relocate to Northern California by November 2010.

2. **Cash Compensation.** The Company will pay you a starting salary at the rate of Two Hundred Twenty-Five Thousand Dollars (\$225,000) per year, payable in accordance with the Company's standard payroll schedule. Your salary will be subject to adjustment pursuant to the Company's employee compensation policies in effect from time to time. In addition, during your first twelve months of employment, and subject to your continued employment with the Company, you will be eligible to earn incentive compensation of up to One Hundred Forty Five Thousand Dollars (\$145,000) (the "**First Year Incentive Payment**"), based upon achievement of sales targets to be determined by the Company's Chief Executive Officer after consulting with you within thirty (30) days of your first day of employment (the "**First Year Sales Targets**"). Incentive compensation in future periods, subject to your continued employment with the Company, are to be determined by the Company's Chief Executive Officer after consulting with you. Incentive compensation payment(s) will be paid to you within 60 days following the date that the Company determines that the applicable incentive bonus has been

earned, if any. You must be an employee in good standing on the date that an incentive compensation payment is to be paid in order to earn such payment.

3. Relocation Expenses. You will be eligible for reimbursement of up to Fifty Thousand Dollars (\$50,000) in qualified relocation expenses for your move to Northern California in accordance with the Company's expense reimbursement policies provided that you complete your relocation by May 2011 and that you are an employee in good standing on the date on which you submit the qualified expenses for reimbursement. You will be responsible for all state and federal income and employment taxes associated with these expense payments.

4. Employee Benefits. As a regular employee of the Company, you will be eligible to participate in regular health insurance, profit sharing, bonus, and other employee benefit plans if and as established by the Company for its employees from time to time. In addition to your gross salary, the Company will make an annual contribution on your behalf to the Company's 401(k) Plan of three percent (3%) of your "compensation", as set forth in the Company's 401(k) Plan, for the preceding 12-month period, subject to the provisions of the Company's 401(k) Plan. The Company may change or cease to make these contributions in future calendar years by providing notice in advance of the beginning of the next plan year. In addition, you will be entitled to paid vacation in accordance with the Company's vacation policy, as in effect from time to time.

5. Expenses. You will be reimbursed for reasonable legitimate business expenses incurred in the performance of your duties in accordance with the Company's expense reimbursement policies, as in effect from time to time. In addition, the Company will reimburse you for the cost of renting an apartment in Northern California for up to three (3) months prior to the completion of your relocation.

6. Stock Option Grant. Following execution of this letter agreement, we will recommend to the Board of Directors of the Company that you be granted a stock option (the "**Option**") to purchase up to .75% of the Company's fully diluted outstanding capitalization (to be determined following the final closing of the Company's current Series E financing transaction) under the Company's 2006 Equity Incentive Plan (the "**Plan**"). The exercise price per share will be equal to the fair market value per share on the date the Board approves such Option grant or on your first day of employment, whichever is later. The Option will be subject to the terms and conditions applicable to options

granted under the Plan, as described in and subject to the Plan and the applicable stock option agreement. Subject to your continued employment and the terms and conditions of the Plan and applicable agreement and except as otherwise described in Section 7 below, twenty-five percent (25%) of the Option shares will vest and become exercisable twelve (12) months following your first day of employment, and the balance will vest and become exercisable in equal monthly installments over the next thirty-six (36) months of continuous service, as described in the applicable stock option agreement.

With respect to the foregoing, the grant of the opportunity to purchase such shares by the Company is subject to the Board's approval and this promise to recommend such approval is not a promise of compensation and is not intended to create any obligation on the part of the Company.

7. Stock Option Vesting Acceleration Upon Termination of Employment Following a Change of Control. In the event of a Change of Control and, following such Change of Control, your employment is terminated by the Company or the surviving entity as a result of an involuntary termination other than for Cause at any time within 24 months of your first day of employment with the Company, then the Option referenced in Section 6 shall become immediately vested as to 50% of the total number of Option shares (including shares previously vested). No benefits under this Section 7 will apply after 24 months of your first day of employment with the Company, and the foregoing option vesting arrangement will only apply to the Option (your initial option grant referenced in Section 6), unless otherwise approved by the Board.

8. Parachute Payments. In the event that the acceleration and severance benefits provided for in this letter agreement and otherwise (A) constitute "parachute payments" within the meaning of Section 280G of the Internal Revenue Code of 1986, as amended (the "Code") and (B) but for this paragraph, would be subject to the excise tax imposed by Section 4999 of the Code, then your benefits hereunder shall be payable either: (X) in full, or (Y) as to such lesser amount which would result in no portion of such severance benefits being subject to excise tax under Section 4999 of the Code, whichever of the foregoing amounts, taking into account the applicable federal, state and local income taxes and the excise tax imposed by Section 4999, results in the receipt by you on an after-tax basis, of the greatest amount of benefits hereunder, notwithstanding that all or some portion of such benefits may be taxable under Section 4999 of the Code. Unless the Company and you otherwise agree in

writing, any determination required under this paragraph shall be made in writing by the public accountants designated by the Company (the “**Accountants**”), whose determination shall be conclusive and binding upon you and the Company for all purposes. For purposes of making the calculations required by this paragraph, the Accountants may make reasonable assumptions and approximations concerning applicable taxes and may rely on reasonable, good faith interpretations concerning the application of Section 280G and 4999 of the Code. The Company and you shall furnish to the Accountants such information and documents as the Accountants may reasonably request in order to make a determination under this paragraph. The Company shall bear all costs the Accountants may reasonably incur in connection with any calculations contemplated by this paragraph. In the event that a reduction in payments and/or benefits is required under this paragraph, such reduction shall occur in the following order: (1) reduction of cash payments; (2) reduction of acceleration of vesting of options and shares; and (3) reduction of other benefits paid to you. If the acceleration of vesting of options and shares is to be reduced, such acceleration of vesting shall be cancelled in the reverse order of the highest price option grant or highest purchase price per share down to the lowest priced option grant or lowest purchase price per share.

9. Employment Relationship. Employment with the Company is for no specific period of time. Your employment with the Company will be “at will,” meaning that either you or the Company may terminate your employment at any time and for any reason, with or without cause. Any contrary representations that may have been made to you are superseded by this letter agreement. This is the full and complete agreement between you and the Company on this term. Although your job duties, title, compensation and benefits, as well as the Company’s personnel policies and procedures, may change from time to time, the “at will” nature of your employment may only be changed in an express written agreement signed by you and a duly authorized officer of the Company (other than you).

Notwithstanding the foregoing, if your employment is terminated by the Company as a result of an involuntary termination other than for Cause at any time within 12 months of your first day of employment with the Company, then, subject to the terms set forth in this letter agreement, you will be entitled to receive severance benefits as follows: (i) severance payments for a period of three (3) months following the date of your termination (the “**Severance Period**”) equal to your then current base salary, which payments shall be paid during the Severance Period in accordance with the Company’s standard payroll practices,

and (ii) continuation of the health insurance benefits provided to you for you and your eligible dependents at Company expense pursuant to the terms of the Consolidated Omnibus Budget Reconciliation Act of 1985, as amended (“**COBRA**”) or other applicable law through the earlier of the end of the Severance Period or the date upon which you are no longer eligible for such COBRA or other benefits under applicable law. For the avoidance of doubt, no benefits under this paragraph will apply after 12 months of your first day of employment with the Company.

10. Limitations and Conditions on Benefits.

(a) **Income and Employment Taxes.** You agree that you shall be responsible for any applicable taxes of any nature (including any penalties or interest that may apply to such taxes) that the Company reasonably determines apply to any payment made under this letter agreement, that your receipt of any benefit hereunder is conditioned on your satisfaction of any applicable withholding or similar obligations that apply to such benefit, and that any cash payment owed hereunder will be reduced to satisfy any such withholding or similar obligations that may apply.

(b) **Code Section 409A.** All payments to be made upon a termination of employment under this Agreement may be made only upon a “separation from service” within the meaning of Section 409A of the Internal Revenue Code of 1986, as amended (the “**Code**”), and the Department of Treasury regulations and other guidance promulgated thereunder (a “**Separation from Service**”). Notwithstanding any provision of this Agreement to the contrary, if, at the time of your termination of employment with the Company, you are a “specified employee” (as defined in Section 409A of the Code) and the deferral of the commencement of any severance payments or benefits otherwise payable pursuant to this letter agreement as a result of such termination of employment is necessary in order to prevent any accelerated or additional tax under Section 409A of the Code, then the Company will defer the commencement of the payment of any such severance payments or benefits hereunder (without any reduction in such payments or benefits ultimately paid or provided to you) that will not and could not under any circumstances, regardless of when such termination occurs, be paid in full by March 15 of the year following your termination and are in excess of the lesser of (i) two (2) times your then annual compensation or (ii) two (2) times the limit on compensation then set forth in Section 401 (a)(17) of the Code and will not be paid by the end of the second

calendar year following the year in which the termination occurs, until the first payroll date that occurs after the date that is six (6) months following your Separation from Service with the Company (as defined under Code Section 409A). If any payments are deferred due to such requirements, such amounts will be paid in a lump sum to you on the earliest of (a) your death following the date of your termination of employment with the Company or (ii) the first payroll date that occurs after the date that is six (6) months following your Separation from Service with the Company. For these purposes, each severance payment or benefit is hereby designated as a separate payment or benefit and will not collectively be treated as a single payment or benefit. This paragraph is intended to comply with the requirements of Section 409A of the Code so that none of the severance payments and benefits to be provided hereunder will be subject to the additional tax imposed under Section 409A of the Code and any ambiguities herein will be interpreted to so comply. You and the Company agree to work together in good faith to consider amendments to this Agreement and to take such reasonable actions which are necessary, appropriate or desirable to avoid imposition of any additional tax or income recognition prior to actual payment to you under Section 409A of the Code.

To the extent that any reimbursements or expense payments payable to you are subject to the provisions of Section 409A of the Code, any such reimbursements or payments shall be paid no later than December 31 of the year following the year in which the expense was incurred, the amount of expenses reimbursed in one year shall not affect the amount eligible for reimbursement in any subsequent year, and the right to reimbursement will not be subject to liquidation or exchange for another benefit.

(c) **Release Prior to Receipt of Benefits.** As a condition of receiving the termination benefits under this letter agreement, you shall execute, and allow to become effective, a release of claims agreement (the "Release") not later than fifty (50) days following your Separation from Service in the form provided by the Company. Such Release shall specifically relate to all of your rights and claims in existence at the time of such execution and shall confirm your obligations under the Company's standard Employee Invention Assignment and Confidentiality Agreement. Unless the Release is timely executed by you, delivered to the Company, and becomes effective within the required period (the date on which the Release becomes effective, the "Release Date"), you will not receive any of the benefits provided for under this letter agreement. In no event will benefits be provided to you until the Release becomes effective. Any lump

sum payment owed to you shall be paid within ten (10) business days following the Release Date, but in no event later than March 15 of the year following the year in which the applicable event occurs.

11. **Confidentiality.** As an employee of the Company, you will have access to certain confidential information of the Company and you may, during the course of your employment, develop certain information or inventions that will be the property of the Company. To protect the interests of the Company, you will need to sign the Company's standard "Employee Invention Assignment and Confidentiality Agreement" attached hereto as Exhibit A as a condition of your employment. We wish to impress upon you that we do not want you to, and we hereby direct you not to, bring with you any confidential or proprietary material of any former employer or to violate any other obligations you may have to any former employer. During the period that you render services to the Company, you agree to not engage in any employment, business or activity that is in any way competitive with the business or proposed business of the Company. You will disclose to the Company in writing any other gainful employment, business or activity that you are currently associated with or participate in that competes with the Company. You will not assist any other person or organization in competing with the Company or in preparing to engage in competition with the business or proposed business of the Company. You represent that your signing of this offer letter, agreement(s) concerning stock options granted to you, if any, under the Plan and the Company's Employee Invention Assignment and Confidentiality Agreement and your commencement of employment with the Company will not violate any agreement currently in place between yourself and current or past employers.

12. **Definition of Terms.** The following terms referred to in this letter agreement shall have the following meanings:

(a) **Change of Control.** "Change of Control" shall mean a sale of all or substantially all of the Company's assets, or any merger or consolidation of the Company with or into another corporation other than a merger or consolidation in which the holders of more than 50% of the shares of capital stock of the Company outstanding immediately prior to such transaction continue to hold (either by voting securities remaining outstanding or by their being converted into voting securities of the surviving entity) more than 50% of the total voting power represented by the voting securities of the Company, or such surviving entity, outstanding immediately after such transaction. For

purposes of clarification, neither an equity financing occurring prior to an IPO nor an IPO will be a Change of Control, even if equity securities representing greater than 50% of the total voting power of the Company are sold in the transaction.

(b) **Cause.** “Cause” shall mean, as determined by the Board of Directors of the Company acting in good faith and based on information then known to it: (A) gross negligence or willful misconduct in the performance of duties to the Company where such gross negligence or willful misconduct has resulted or is likely to result in substantial and material damage to the Company or its subsidiaries; (B) a material failure to comply with the Company’s written policies after having received from the Company notice of, and a reasonable time to cure, such failure; (C) repeated unexplained or unjustified absence from the Company; (D) conviction of a felony or a crime involving moral turpitude causing material harm to the standing and reputation of the Company; (E) unauthorized use or disclosure of any proprietary information or trade secrets of the Company or any other party to whom you owe an obligation of non-disclosure as a result of your relationship with the Company, which use or disclosure causes or is likely to cause material harm to the Company; or (F) your death or Permanent Disability.

(c) **Permanent Disability.** “Permanent Disability” shall mean your inability to engage in any substantial gainful activity by reason of any medically determinable physical or mental impairment which can be expected to result in death or which has lasted or can be expected to last for a continuous period of not less than six (6) months.

13. Interpretation, Amendment and Enforcement. This letter agreement and Exhibit A constitute the complete agreement between you and the Company, contain all of the terms of your employment with the Company and supersede any prior agreements, representations or understandings (whether written, oral or implied) between you and the Company. This letter agreement may not be amended or modified, except by an express written agreement signed by both you and a duly authorized officer of the Company. The terms of this letter agreement and the resolution of any disputes as to the meaning, effect, performance or validity of this letter agreement or arising out of, related to, or in any way connected with, this letter agreement, your employment with the Company or any other relationship between you and the Company (the “*Disputes*”) will be governed by California law, excluding laws relating to conflicts or choice of law. You and the Company submit to the exclusive personal

jurisdiction of the federal and state courts located in San Francisco and Sonoma County in connection with any Dispute or any claim related to any Dispute.

EXHIBIT A

EMPLOYEE INVENTION ASSIGNMENT AND CONFIDENTIALITY AGREEMENT

In consideration of, and as a condition of my employment with Enphase Energy, Inc., a Delaware corporation (the “*Company*”), I hereby represent to, and agree with the Company as follows:

Purpose of Agreement. I understand that the Company is engaged in a continuous program of research, development, production and marketing in connection with its business and that it is critical for the Company to preserve and protect its Proprietary Information (as defined in Section 7 below), its rights in Inventions (as defined in Section 2 below) and in all related intellectual property rights. Accordingly, I am entering into this Employee Invention Assignment and Confidentiality Agreement (this “*Agreement*”) as a condition of my employment with the Company, whether or not I am expected to create inventions of value for the Company.

Disclosure of Inventions. I will promptly disclose in confidence to the Company all inventions, improvement designs, original works of authorship, formulas, processes, compositions of matter, computer software programs, databases, mask works, designs and trade secrets that I make or conceive or first reduce to practice or create, either alone or jointly with others, during the period of my employment, whether or not in the course of my employment, and whether or not patentable, copyrightable or protectable as trade secrets (the “*Inventions*”).

Inventions Retained and Licensed. I have attached hereto, as Exhibit A, a list describing with particularity all inventions, original works of authorship, developments, improvements, and trade secrets which were made by me prior to the commencement of my employment with the Company (collectively referred to as “*Prior Inventions*”), which belong solely to me or belong to me jointly with another, which relate in any way to any of the Company’s proposed businesses, products or research and development, and which are not assigned to the Company hereunder; or, if no such list is attached, I represent that there are no such Prior Inventions. If, in the course of my employment with the Company, I incorporate into a Company product, process or machine a Prior Invention owned by me or in which I have an interest, the Company is hereby granted and shall have a non-exclusive, royalty-free, irrevocable, perpetual, worldwide license (with the right to sublicense) to make, have made, copy, modify, make derivative

works of, use, sell and otherwise distribute such Prior Invention as part of or in connection with such product, process or machine.

Work for Hire; Assignment of Inventions. I acknowledge and agree that any copyrightable works prepared by me within the scope of my employment are “works for hire” under the Copyright Act and that the Company will be considered the author and owner of such copyrightable works. I agree that all Inventions that (i) are developed using equipment, supplies, facilities or trade secrets of the Company, (ii) result from work performed by me for the Company, or (iii) relate to the Company’s business or current or anticipated research and development (the “**Assigned Inventions**”), will be the sole and exclusive property of the Company and are hereby irrevocably assigned by me to the Company.

Labor Code Section 2870 Notice. I have been notified and understand that the provisions of Sections 3 and 5 of this Agreement do not apply to any Assigned Invention that qualifies fully under the provisions of Section 2870 of the California Labor code, which states as follows:

ANY PROVISION IN AN EMPLOYMENT AGREEMENT WHICH PROVIDES THAT AN EMPLOYEE SHALL ASSIGN, OR OFFER TO ASSIGN, ANY OF HIS OR HER RIGHTS IN AN INVENTION TO HIS OR HER EMPLOYER SHALL NOT APPLY TO AN INVENTION THAT THE EMPLOYEE DEVELOPED ENTIRELY ON HIS OR HER OWN TIME WITHOUT USING THE EMPLOYER’S EQUIPMENT, SUPPLIES, FACILITIES, OR TRADE SECRET INFORMATION EXCEPT FOR THOSE INVENTIONS THAT EITHER: (1) RELATE AT THE TIME OF CONCEPTION OR REDUCTION TO PRACTICE OF THE INVENTION TO THE EMPLOYER’S BUSINESS, OR ACTUAL OR DEMONSTRABLY ANTICIPATED RESEARCH OR DEVELOPMENT OF THE EMPLOYER; OR (2) RESULT FROM ANY WORK PERFORMED BY THE EMPLOYEE FOR THE EMPLOYER. TO THE EXTENT A PROVISION IN AN

EMPLOYMENT AGREEMENT PURPORTS TO REQUIRE AN EMPLOYEE TO ASSIGN AN INVENTION OTHERWISE EXCLUDED FROM BEING REQUIRED TO BE ASSIGNED UNDER CALIFORNIA LABOR CODE SECTION 2870(a), THE PROVISION IS AGAINST THE PUBLIC POLICY OF THIS STATE AND IS UNENFORCEABLE.

Assignment of Other Rights. In addition to the foregoing assignment of Assigned Inventions to the Company, I hereby irrevocably transfer and assign to the Company: (i) all worldwide patents, patent applications, copyrights, mask works, trade secrets and other intellectual property rights, including but not limited to rights in databases, in any Assigned Inventions, along with any registrations of or applications to register such rights and (ii) any and all “Moral Rights” (as defined below) that I may have in or with respect to any Assigned Inventions. I also hereby forever waive and agree never to assert any and all Moral Rights I may have in or with respect to any Assigned Inventions, even after termination of my work on behalf of the Company. “**Moral Rights**” mean any rights to claim authorship of or credit on an Assigned Inventions, to object to or prevent the modification or destruction of any Assigned Inventions, or to withdraw from circulation or control the publication or distribution of any Assigned Inventions, and any similar right, existing under judicial or statutory law of any country or subdivision thereof in the world, or under any treaty, regardless of whether or not such right is denominated or generally referred to as “moral rights.”

Assistance. I agree to assist the Company in every proper way to obtain for the Company and enforce patents, copyrights, mask work rights, trade secret rights and other legal protections for the Company’s Assigned Inventions in any and all countries. I will execute any documents that the Company may reasonably request for use in obtaining or enforcing such patents, copyrights, mask work rights, trade secrets and other legal protections. My obligations under this paragraph will continue beyond the termination of my employment with the Company, provided, that the Company will compensate me at a reasonable rate after such termination for time or expenses actually spent by me at the company’s request on such assistance. I appoint the Secretary of the Company as my attorney-in-fact to execute documents on my behalf for this purpose.

Proprietary Information. I understand that my employment by the Company creates a relationship of confidence and trust with respect to any information of a confidential or secret nature that may be disclosed to me by the Company or a third party that relates to the business of the Company or to the business of any parent, subsidiary, affiliate, customer or supplier of the Company or any other party with whom the Company agrees to hold information of such party in confidence (the “***Proprietary Information***”). Such Proprietary Information includes, but is not limited to, Assigned Inventions, marketing plans, product plans, business strategies, financial information, forecasts, personnel information, customer lists and data, and domain names.

Confidentiality. At all times, both during my employment and after its termination, I will keep and hold all such Proprietary Information in strict confidence and trust. I will not use or disclose any Proprietary Information without the prior written consent of the Company, except as may be necessary to perform my duties as an employee of the Company for the benefit of the Company. Upon termination of my employment with the Company, I will promptly deliver to the Company all documents and materials of any nature pertaining to my work with the Company and, upon Company request, will execute a document confirming my agreement to honor my responsibilities contained in this Agreement. I will not take with me or retain any documents or materials or copies thereof containing any Proprietary Information.

No Breach of Prior Agreement. I represent that my performance of all the terms of this Agreement and my duties as an employee of the Company will not breach any invention assignment, proprietary information, confidentiality or similar agreement with any former employer or other party. I represent that I will not bring with me to the Company or use in the performance of my duties for the Company any documents or materials or intangibles of a former employer or third party that are not generally available to the public or have not been legally transferred to the Company.

Efforts: Duty Not to Compete. I understand that my employment with the Company requires my undivided attention and effort during normal business hours. While I am employed by the Company, I will not, without the Company’s express prior written consent, provide services to, or assist in any manner, any business or third party if such services or assistance would be in direct conflict with the Company’s business interests.

Notification. I hereby authorize the Company to notify third parties, including, without limitation, customers and actual or potential employers, of the terms of this Agreement and my responsibilities hereunder.

Non-Solicitation of Employees/Consultants. During my employment with the Company and for a period of one (1) year thereafter, I will not directly or indirectly solicit away employees or consultants of the Company for my own benefit or for the benefit of any other person or entity.

Non-Solicitation of Suppliers/Customers. During my employment with the Company and after termination of my employment, I will not directly or indirectly solicit or take away suppliers or customers of the Company if the identity of the supplier or customer or information about the supplier or customer relationship is a trade secret or is otherwise deemed confidential information within the meaning of California law.

Name and Likeness Rights. I hereby authorize the Company to use, reuse, and to grant others the right to use and reuse, my name, photograph, likeness (including caricature), voice, and biographical information, and any reproduction or simulation thereof, in any form of media or technology now known or hereafter developed (including, but not limited to, film, video and digital or other electronic media), both during and after my employment, for any purposes related to the Company's business, such as marketing, advertising, credits, and presentations.

Injunctive Relief. I understand that in the event of a breach or threatened breach of this Agreement by me the Company may suffer irreparable harm and will therefore be entitled to injunctive relief to enforce this Agreement.

Governing Law; Severability. This Agreement will be governed by and construed in accordance with the laws of the State of California, without giving effect to its laws pertaining to conflict of laws. If any provision of this Agreement is determined by any court or arbitrator of competent jurisdiction to be invalid, illegal or unenforceable in any respect, such provision will be enforced to the maximum extent possible given the intent of the parties hereto. If such clause or provision cannot be so enforced, such provision shall be stricken from this Agreement and the remainder of this Agreement shall be enforced as if such invalid, illegal or unenforceable clause or provision had (to the extent not enforceable) never been contained in this Agreement.

Counterparts. This Agreement may be executed in any number of counterparts, each of which when so executed and delivered will be deemed an original, and all of which together shall constitute one and the same agreement.

Entire Agreement. This Agreement and the documents referred to herein constitute the entire agreement and understanding of the parties with respect to the subject matter of this Agreement, and supersede all prior understandings and agreements, whether oral or written, between or among the parties hereto with respect to the specific subject matter hereof.

Amendment and Waivers. This Agreement may be amended only by a written agreement executed by each of the parties hereto. No amendment or waiver of, or modification of any obligation under this Agreement will be enforceable unless set forth in a writing signed by the party against which enforcement is sought. Any amendment effected in accordance with this section will be binding upon all parties hereto and each of their respective successors and assigns. No delay or failure to require performance of any provision of this Agreement shall constitute a waiver of that provision as to that or any other instance. No waiver granted under this Agreement as to any one provision herein shall constitute a subsequent waiver of such provision or of any other provision herein, nor shall it constitute the waiver of any performance other than the actual performance specifically waived.

Successors and Assigns; Assignment. Except as otherwise provided in this Agreement, this Agreement, and the rights and obligations of the parties hereunder, will be binding upon and inure to the benefit of their respective successors, assigns, heirs, executors, administrators and legal representatives. The Company may assign any of its rights and obligations under this Agreement. No other party to this Agreement may assign, whether voluntarily or by operation of law, any of its rights and obligations under this Agreement, except with the prior written consent of the Company.

Further Assurances. The parties agree to execute such further documents and instruments and to take such further actions as may be reasonably necessary to carry out the purposes and intent of this Agreement.

“At Will” Employment. I understand that this Agreement does not constitute a contract of employment or obligate the Company to employ me for any stated period of time. I understand that I am an “at will” employee of the

Company and that my employment can be terminated at any time, with or without notice and with or without cause, for any reason or for no reason, by either the Company or myself. I acknowledge that any statements or representations to the contrary are ineffective, unless put into a writing signed by the Company. I further acknowledge that my participation in any stock option or benefit program is not to be construed as any assurance of continuing employment for any particular period of time. This Agreement shall be effective as of the first day of my employment by the Company, which is May 3, 2010.

* * * * *

In Witness Whereof, the parties have executed this Agreement as of 3 May, 2010.

Enphase Energy, Inc.:

By: /s/ Paul Nahi

Name: Paul Nahi

Title: President and CEO

Employee:

/s/ Jeff Loebbaka
Signature

[Employee Name] Jeff Loebbaka

Signature Page to Employee Invention Assignment and Confidentiality Agreement

EXHIBIT A

**LIST OF PRIOR INVENTIONS
AND ORIGINAL WORKS OF AUTHORSHIP**

Title

Date

Identifying Number
or Brief Description

No inventions or improvements

Additional Sheets Attached

Signature of Employee: /s/ Jeff Loebbaka

Print Name of Employee: Jeff Loebbaka

Date: 4-21-10

EMPLOYMENT AGREEMENT

This Employment Agreement (the "**Agreement**") is entered into as of March 21, 2006 (the "**Effective Date**") between PVI Solutions, Inc., a Delaware corporation with its principal offices located at 25 Halsey Avenue, Petaluma, California 94952 (the "**Company**"), and Raghuvver R. Belur, a resident of California (the "**Employee**").

In consideration of the promises and the terms and conditions set forth in this Agreement, the parties agree as follows:

1. Position. During the term of this Agreement, Company will employ Employee, and Employee will serve Company in the capacity of President and Chief Executive Officer and will be appointed as a member of Company's Board of Directors. Employee will report directly to the Company's Board of Directors.

2. Duties. Employee will perform duties that are executive in nature, consistent with his title; provided, however, that the Company shall not, without Employee's express written consent, require Employee to be based anywhere other than in Sonoma County or Marin County, except for required travel on the Company's business to an extent substantially consistent with travel required of persons who hold similar positions or have similar duties with the Company.

3. Exclusive Service. Employee will devote substantially all his working time and efforts to the business and affairs of the Company. The foregoing shall not, however, preclude Employee (a) from engaging in appropriate civic, charitable or religious activities, (b) from devoting a reasonable amount of time to private investments and business interests, (c) from serving on the boards of directors or advisors of, or as a consultant to, other entities, or (d) from providing incidental assistance to family members on matters of family business, so long as the foregoing activities and service do not conflict with Employee's responsibilities to the Company.

4. Term of Employment.

4.1 Initial Term. The Company agrees to continue Employee's employment, and Employee agrees to remain in the employ of the Company, for a period of five (5) years after the Effective Date unless Employee's employment is earlier terminated pursuant to the provisions of this Agreement.

4.2 Renewal. The term of Employee's employment shall be extended automatically, without further action of either party, as of five (5) years after the Effective Date and on each succeeding anniversary of that date, for terms of one (1) year, unless on or before ninety (90) days prior to the last day of the term of Employee's employment or any extension thereof, the Company or Employee shall notify the other in writing of its intention not to renew Employee's employment, in which case Employee's employment shall terminate at the end of the original term or any extension thereof. If either party notifies the other of its intention not to renew Employee's employment less than ninety (90) days prior to the end of the term of this Agreement or any extension thereof, then such termination shall be effective ninety (90) days from such notice. No notice of non-renewal may be given by either party after a renewal term has commenced. Any such renewal shall be upon such terms and conditions set forth herein,

unless otherwise agreed between the Company and Employee. The notice of non-renewal by either party shall in no way constitute a breach of this Agreement.

4.3 Termination of Agreement. This Agreement shall terminate on the date on which all obligations of the parties hereto have been satisfied.

5. Compensation and Benefits.

5.1 Base Salary. The Company agrees to pay Employee a minimum annual salary of sixty thousand dollars (\$60,000), or in the event of any portion of a year, a pro rata amount of such annual salary. Employee's base salary shall be reviewed by the Board of Directors for possible increases prior to the start of each fiscal year, effective at the beginning of such fiscal year. Employee's salary will be payable as earned in accordance with Company's customary payroll practice.

5.2 Cash Bonus. Employee will be eligible to receive an annual cash bonus in the discretion of the Board of Directors,

5.3 Additional Benefits. Employee will be eligible to participate in Company's employee benefit plans of general application, including without limitation pension and profit-sharing plans, deferred compensation, supplemental retirement or excess-benefit plans, stock option, incentive or other bonus plans, life, health, disability, accident and dental insurance programs, 401(k) plan, paid vacations and sabbatical leave plans, and similar plans or programs, in accordance with the rules established for individual participation in any such plan. Employee shall be entitled each year to four (4) weeks leave for vacation at full pay, provided, that at the end of each year, Employee may accrue and carry over to the next succeeding year a maximum of two (2) weeks of unused vacation. Employee shall also be entitled to reasonable holidays and illness days with full pay in accordance with the Company's policy from time to time in effect.

5.4 Stock Options. Employee will be eligible to receive stock grants and stock option awards in the discretion of the Board of Directors.

5.5 Expenses. The Company will reimburse Employee for all reasonable and necessary expenses incurred by Employee in connection with the Company's business, provided that such expenses are in accordance with applicable policy set by the Board from time to time and are properly documented and accounted for in accordance with the policy of the Company and with the requirements of the Internal Revenue Service.

6. Proprietary Rights. Employee hereby agrees to execute an Employee Invention Assignment and Confidentiality Agreement with the Company in substantially the form attached hereto as Exhibit A.

7. Termination.

7.1 Events of Termination. Employee's employment with the Company shall terminate upon any one of the following:

(a) sixty (60) days after the effective date of a written notice sent to Employee stating the Company's determination made in good faith that it is terminating

Employee for “Cause” as defined under Section 7.2 below (“**Termination for Cause**”), provided, that if the “Cause” for termination is a curable failure by Employee to properly perform his assigned duties, then the Company will give Employee written notice of such failure (a “**Cause Notice**”), and if Employee failure to cure such failure to the reasonable satisfaction of the Board of Directors within sixty (60) days after the Company gives the Cause Notice, then the Company may immediately terminate Employee’s employment, and such termination will be conclusively deemed to be for “cause” hereunder; or

(b) thirty (30) days after the effective date of a written notice sent to Employee stating the Company’s determination made in good faith that, due to a mental or physical incapacity, Employee has been unable to perform his duties under this Agreement for a period of not less than six (6) consecutive months or 180 days in the aggregate in any 12-month period unless Employee has been on a leave approved by the Company’s Board of Directors (“**Termination for Disability**”); or

(c) Employee’s death (“**Termination Upon Death**”); or

(d) the effective date of a written notice sent to the Company stating Employee’s determination made in good faith of “Constructive Termination” by the Company, as defined under Section 7.3 below (“**Constructive Termination**”); or

(e) thirty (30) days after the effective date of a notice sent to Employee stating that the Company is terminating his employment, without cause, which notice can be given by the Company at any time after the Effective Date at the Company’s sole discretion, for any reason or for no reason (“**Termination Without Cause**”); or

(f) the effective date of a notice sent to the Company from Employee stating that Employee is electing to terminate his employment with the Company (“**Voluntary Termination**”).

7.2 “Cause” Defined. For purposes of this Agreement, “cause” for Employee’s termination means Employee’s conviction of a felony involving moral turpitude/will exist at any time after the happening of one or more of the following events:

(a) any willful act or acts of dishonesty undertaken by Employee and intended to result in substantial gain or personal enrichment of Employee at the expense of the Company; or

(b) any willful act of gross misconduct which is materially and demonstrably injurious to the Company.

No act, or failure to act, by Employee shall be considered “willful” if done, or omitted to be done, by him in good faith and in the reasonable belief that his act or omission was in the best interest of the Company and/or required by applicable law.

7.3 “Constructive Termination” Defined. “Constructive Termination” shall mean:

(a) a material reduction in Employee's salary or benefits not agreed to by Employee; or

(b) a material change in Employee's responsibilities not agreed to by Employee; or

(c) the Company's failure to comply in any material respect with any material term of this Agreement; or

(d) a requirement that Employee relocate to an office that would increase Employee's one-way commute distance by more than forty

(40) miles; or

(e) a "Change in Control" of the Company, as defined herein. A "Change in Control" means the occurrence of any of the following events:

(i) any sale or exchange of the capital stock by the shareholders of the Company in one transaction or series of related transactions where more than 50% of the outstanding voting power of the Company is acquired by a person or entity or group of related persons or entities; or (ii) any reorganization, consolidation or merger of the Company where the outstanding voting securities of the Company immediately before the transaction represent or are converted into less than fifty percent 50% of the outstanding voting power of the surviving entity (or its parent corporation) immediately after the transaction; or (iii) the consummation of any transaction or series of related transactions that results in the sale of all or substantially all of the assets of the Company; or (iv) any "person" or "group" (as defined in the Securities Exchange Act of 1934, as amended (the "*Exchange Act*")) becoming the "beneficial owner" (as defined in Rule 13d-3 under the Exchange Act) directly or indirectly of securities representing more than fifty percent (50%) of the voting power of the Company then outstanding; or (v) less than a majority of the Board of Directors are persons who were either nominated for election by the Board of Directors or were elected by the Board of Directors.

8. Effect of Termination.

8.1 Termination for Cause or Voluntary Termination. In the event of any termination of Employee's employment pursuant to Section 7.1(a) or Section 7.1(f), the Company shall immediately pay to Employee the compensation and benefits otherwise payable to Employee under Section 5 through the date of termination. Employee's rights under the Company's benefit plans of general application shall be determined under the provisions of those plans.

8.2 Termination for Disability. In the event of termination of employment pursuant to Section 7.1(b):

(a) the Company shall immediately pay to Employee the compensation and benefits otherwise payable to Employee under Section 5 through the date of termination,

(b) for six (6) months after the termination of Employee's employment, the Company shall continue to pay Employee (A) his salary under Section 5.1 above at Employee's then-current salary, less applicable withholding taxes, payable on the Company's normal payroll dates during that period, (B) his annual cash bonus, if any, under Section 5.2 above, and (C) shall continue his benefits under Section 5.3 above, and

(c) Employee shall receive other severance and disability payments as provided in the Company's standard benefit plans.

If Employee's employment is terminated pursuant to Section 7.1(b) and Employee resumes the performance of substantially all of his duties hereunder before five (5) years after the Effective Date, Employee may notify the Company that Employee is choosing to reinstate this Agreement as though it had never been terminated. Within thirty (30) days of the Effective Date, the Company will procure disability insurance sufficient to fund its obligations to Employee hereunder, naming the Employee as payee. The Company shall maintain such insurance in force at all times that Employee is employed pursuant to this Agreement.

8.3 Termination Upon Death. In the event of termination of employment pursuant to Section 7.1(c), all obligations of the Company and Employee shall cease, except the Company shall immediately pay to Employee (or to Employee's estate) the compensation and benefits otherwise payable to Employee under Section 5 through the date of termination.

8.4 Constructive Termination or Termination Without Cause. In the event of any termination of this Agreement pursuant to Section 7.1(d) or Section 7.1(e),

(a) the Company shall immediately pay to Employee the compensation and benefits otherwise payable to Employee under Section 5 through the date of termination, and

(b) for the longer of (i) six (6) months after the termination of Employee's employment, or (ii) five (5) years after the Effective Date, the Company shall continue to pay Employee (A) his salary under Section 5.1 above at Employee's then-current salary, less applicable withholding taxes, payable on the Company's normal payroll dates during that period, (B) his annual cash bonus, if any, under Section 5.2 above, and (C) shall continue his benefits under Section 5.3 above, and

(c) all of Employee's options to purchase the Company's Common Stock shall, as of the date of employment termination, be immediately exercisable in full and shall remain exercisable for the periods specified in such options or the plans governing such options, and all shares of the Company's Common Stock owned by Employee shall immediately be released from any and all vesting restrictions; provided, that if the total amount of the benefits available to Employee under this Section 8.4, either alone or together with other payments which Employee has the right to receive from the Company, would constitute a "parachute payment" as defined in Section 280G of the Internal Revenue Code of 1986, as amended (the "Code"), then Employee may elect to either (i) receive such payments in full; or (ii) reduce the total amount of such benefits to the largest amount that would result in no portion of such benefits being subject to the excise tax imposed by Section 4999 of the Code. The determination of any reduction in the benefits available under this Section 8.4 pursuant to the foregoing shall be made by the Company in good faith and any such reduction shall reduce first the cash payable under this Section 8.4, then the acceleration of options, then the vesting of stock.

9. Miscellaneous.

9.1 Arbitration. Employee and Company shall submit to mandatory and exclusive binding arbitration of any controversy or claim arising out of, or relating to, this Agreement or any breach hereof, provided, however, that the parties retain their right to, and shall not be prohibited, limited or in any other way restricted from, seeking or obtaining equitable relief from a court having jurisdiction over the parties. Such arbitration shall be governed by the Federal Arbitration Act and conducted through the American Arbitration Association in the State of California, San Francisco County, before a single neutral arbitrator, in accordance with the National Rules for the Resolution of Employment Disputes of the American Arbitration Association in effect at that time. The parties may conduct only essential discovery prior to the hearing, as defined by the AAA arbitrator. The arbitrator shall issue a written decision which contains the essential findings and conclusions on which the decision is based. The Employee shall bear only those costs of arbitration he or she would otherwise bear had he or she brought a claim covered by this Agreement in court. Judgment upon the determination or award rendered by the arbitrator may be entered in any court having jurisdiction thereof.

9.2 Severability. If any provision of this Agreement shall be found by any arbitrator or court of competent jurisdiction to be invalid or unenforceable, then the parties hereby waive such provision to the extent that it is found to be invalid or unenforceable and to the extent that to do so would not deprive one of the parties of the substantial benefit of its bargain. Such provision shall, to the extent allowable by law and the preceding sentence, be modified by such arbitrator or court so that it becomes enforceable and, as modified, shall be enforced as any other provision hereof, all the other provisions continuing in full force and effect.

9.3 No Waiver. The failure by either party at any time to require performance or compliance by the other of any of its obligations or agreements shall in no way affect the right to require such performance or compliance at any time thereafter. The waiver by either party of a breach of any provision hereof shall not be taken or held to be a waiver of any preceding or succeeding breach of such provision or as a waiver of the provision itself. No waiver of any kind shall be effective or binding, unless it is in writing and is signed by the party against whom such waiver is sought to be enforced.

9.4 Assignment. This Agreement and all rights hereunder are personal to Employee and may not be transferred or assigned by Employee at any time. The Company may assign its rights, together with its obligations hereunder, to any parent, subsidiary, affiliate or successor, or in connection with any sale, transfer or other disposition of all or substantially all of its business and assets, provided, however, that any such assignee assumes the Company's obligations hereunder.

9.5 Withholding. All sums payable to Employee hereunder shall be reduced by all federal, state, local and other withholding and similar taxes and payments required by applicable law.

9.6 Entire Agreement. This Agreement (and the exhibit(s) hereto) constitutes the entire and only agreement and understanding between the parties relating to employment of Employee with Company and this Agreement supersedes and cancels any and all previous contracts, arrangements or understandings with respect to Employee's employment;

except that the Employee Invention Assignment and Confidentiality Agreement shall remain as an independent contract and shall remain in full force and effect according to its terms.

9.7 Amendment. This Agreement may be amended, modified, superseded, cancelled, renewed or extended only by an agreement in writing executed by both parties hereto.

9.8 Notices. All notices and other communications required or permitted under this Agreement shall be in writing and hand delivered, sent by telecopier, sent by registered first class mail, postage pre-paid, or sent by nationally recognized express courier service. Such notices and other communications shall be effective upon receipt if hand delivered or sent by telecopier, five (5) days after mailing if sent by mail, and one (1) day after dispatch if sent by express courier, to the following addresses, or such other addresses as any party shall notify the other parties:

If to the Company:	<u>PVI Solutions, Inc.</u> <u>25 Hasley Avenue</u> <u>Petaluma, CA 94952</u>
Telecopier:	<u>—</u>
Attention:	<u>President</u>
If to Employee:	<u>Raghuveer R. Belur</u> <u>_____</u> <u>_____</u>
Telecopier:	<u>—</u>
Attention:	<u>—</u>

9.9 Binding Nature. This Agreement shall be binding upon, and inure to the benefit of, the successors and personal representatives of the respective parties hereto.

9.10 Headings. The headings contained in this Agreement are for reference purposes only and shall in no way affect the meaning or interpretation of this Agreement. In this Agreement, the singular includes the plural, the plural included the singular, the masculine gender includes both male and female referents, and the word “or” is used in the inclusive sense.

9.11 Counterparts. This Agreement may be executed in two or more counterparts, each of which shall be deemed to be an original but all of which, taken together, constitute one and the same agreement.

9.12 Governing Law. This Agreement and the rights and obligations of the parties hereto shall be construed in accordance with the laws of the State of Delaware, without giving effect to the principles of conflict of laws.

9.13 Attorneys’ Fees. In the event of any claim, demand or suit arising out of or with respect to this Agreement, the prevailing party shall be entitled to reasonable costs and attorneys’ fees, including any such costs and fees upon appeal.

IN WITNESS WHEREOF, the Company and Employee have executed this Agreement as of the date first above written.

“COMPANY”

“EMPLOYEE”

/s/ Martin Fornage

/s/ Raghu Belur

By: Martin Fornage
Secretary

By: Raghu Belur

Signature Page to Employment Agreement

**EMPLOYEE INVENTION ASSIGNMENT AND
CONFIDENTIALITY AGREEMENT**

In consideration of, and as a condition of my employment with PVI Solutions, Inc., a Delaware corporation (the “*Company*”), I hereby represent to, and agree with the Company as follows:

1. Purpose of Agreement. I understand that the Company is engaged in a continuous program of research, development, production and marketing in connection with its business and that it is critical for the Company to preserve and protect its “*Proprietary Information*” (as defined in Section 7 below), its rights in “*Inventions*” (as defined in Section 2 below) and in all related intellectual property rights. Accordingly, I am entering into this Employee Invention Assignment and Confidentiality Agreement (this “*Agreement*”) as a condition of my employment with the Company, whether or not I am expected to create inventions of value for the Company.

2. Disclosure of Inventions. I will promptly disclose in confidence to the Company all inventions, improvements, designs, original works of authorship, formulas, processes, compositions of matter, computer software programs, databases, mask works, designs and trade secrets that I make or conceive or first reduce to practice or create, either alone or jointly with others, during the period of my employment, whether or not in the course of my employment, and whether or not patentable, copyrightable or protectable as trade secrets (the “*Inventions*”).

3. Work for Hire; Assignment of Inventions. I acknowledge and agree that any copyrightable works prepared by me within the scope of my employment are “works for hire” under the Copyright Act and that the Company will be considered the author and owner of such copyrightable works. I agree that all Inventions that (i) are developed using equipment, supplies, facilities or trade secrets of the Company, (ii) result from work performed by me for the Company, or (iii) relate to the Company’s business or current or anticipated research and development (the “*Assigned Inventions*”), will be the sole and exclusive property of the Company and are hereby irrevocably assigned by me to the Company.

4. Labor Code Section 2870 Notice. I have been notified and understand that the provisions of Sections 3 and 5 of this Agreement do not apply to any Assigned Invention that qualifies fully under the provisions of Section 2870 of the California Labor Code, which states as follows:

ANY PROVISION IN AN EMPLOYMENT AGREEMENT WHICH PROVIDES THAT AN EMPLOYEE SHALL ASSIGN, OR OFFER TO ASSIGN, ANY OF HIS OR HER RIGHTS IN AN INVENTION TO HIS OR HER EMPLOYER SHALL NOT APPLY TO AN INVENTION THAT THE EMPLOYEE DEVELOPED ENTIRELY ON HIS OR HER OWN TIME WITHOUT USING THE EMPLOYER’S EQUIPMENT, SUPPLIES, FACILITIES, OR TRADE SECRET INFORMATION EXCEPT FOR THOSE INVENTIONS THAT

EITHER: (1) RELATE AT THE TIME OF CONCEPTION OR REDUCTION TO PRACTICE OF THE INVENTION TO THE EMPLOYER'S BUSINESS, OR ACTUAL OR DEMONSTRABLY ANTICIPATED RESEARCH OR DEVELOPMENT OF THE EMPLOYER; OR (2) RESULT FROM ANY WORK PERFORMED BY THE EMPLOYEE FOR THE EMPLOYER. TO THE EXTENT A PROVISION IN AN EMPLOYMENT AGREEMENT PURPORTS TO REQUIRE AN EMPLOYEE TO ASSIGN AN INVENTION OTHERWISE EXCLUDED FROM BEING REQUIRED TO BE ASSIGNED UNDER CALIFORNIA LABOR CODE SECTION 2870(a), THE PROVISION IS AGAINST THE PUBLIC POLICY OF THIS STATE AND IS UNENFORCEABLE.

5. Assignment of Other Rights. In addition to the foregoing assignment of Assigned Inventions to the Company, I hereby irrevocably transfer and assign to the Company: (i) all worldwide patents, patent applications, copyrights, mask works, trade secrets and other intellectual property rights, including but not limited to rights in databases, in any Assigned Inventions, along with any registrations of or applications to register such rights; and (ii) any and all "Moral Rights" (as defined below) that I may have in or with respect to any Assigned Inventions. I also hereby forever waive and agree never to assert any and all Moral Rights I may have in or with respect to any Assigned Inventions, even after termination of my work on behalf of the Company. "**Moral Rights**" mean any rights to claim authorship of or credit on an Assigned Inventions, to object to or prevent the modification or destruction of any Assigned Inventions, or to withdraw from circulation or control the publication or distribution of any Assigned Inventions, and any similar right, existing under judicial or statutory law of any country or subdivision thereof in the world, or under any treaty, regardless of whether or not such right is denominated or generally referred to as a "moral right."

6. Assistance. I agree to assist the Company in every proper way to obtain for the Company and enforce patents, copyrights, mask work rights, trade secret rights and other legal protections for the Company's Assigned Inventions in any and all countries. I will execute any documents that the Company may reasonably request for use in obtaining or enforcing such patents, copyrights, mask work rights, trade secrets and other legal protections. My obligations under this paragraph will continue beyond the termination of my employment with the Company, provided that the Company will compensate me at a reasonable rate after such termination for time or expenses actually spent by me at the Company's request on such assistance. I appoint the Secretary of the Company as my attorney-in-fact to execute documents on my behalf for this purpose.

7. Proprietary Information. I understand that my employment by the Company creates a relationship of confidence and trust with respect to any information of a confidential or secret nature that may be disclosed to me by the Company or a third party that relates to the business of the Company or to the business of any parent, subsidiary, affiliate, customer or supplier of the Company or any other party with whom the Company agrees to hold information of such party in confidence (the "**Proprietary Information**"). Such Proprietary Information includes, but is not limited to, Assigned Inventions, marketing plans, product plans, business

strategies, financial information, forecasts, personnel information, customer lists and data, and domain names.

8. Confidentiality. At all times, both during my employment and after its termination, I will keep and hold all such Proprietary Information in strict confidence and trust. I will not use or disclose any Proprietary Information without the prior written consent of the Company, except as may be necessary to perform my duties as an employee of the Company for the benefit of the Company. Upon termination of my employment with the Company, I will promptly deliver to the Company all documents and materials of any nature pertaining to my work with the Company and, upon Company request, will execute a document confirming my agreement to honor my responsibilities contained in this Agreement. I will not take with me or retain any documents or materials or copies thereof containing any Proprietary Information.

9. No Breach of Prior Agreement. I represent that my performance of all the terms of this Agreement and my duties as an employee of the Company will not breach any invention assignment, proprietary information, confidentiality or similar agreement with any former employer or other party. I represent that I will not bring with me to the Company or use in the performance of my duties for the Company any documents or materials or intangibles of a former employer or third party that are not generally available to the public or have not been legally transferred to the Company.

10. Efforts; Duty Not to Compete. I understand that my employment with the Company requires my undivided attention and effort during normal business hours. While I am employed by the Company, I will not, without the Company's express prior written consent, provide services to, or assist in any manner, any business or third party if such services or assistance would be in direct conflict with the Company's business interests.

11. Notification. I hereby authorize the Company to notify third parties, including, without limitation, customers and actual or potential employers, of the terms of this Agreement and my responsibilities hereunder.

12. Non-Solicitation of Employees/Consultants. During my employment with the Company and for a period of one (1) year thereafter, I will not directly or indirectly solicit away employees or consultants of the Company for my own benefit or for the benefit of any other person or entity.

13. Non-Solicitation of Suppliers/Customers. During my employment with the Company and after termination of my employment, I will not directly or indirectly solicit or take away suppliers or customers of the Company if the identity of the supplier or customer or information about the supplier or customer relationship is a trade secret or is otherwise deemed confidential information within the meaning of California law.

14. Name and Likeness Rights. I hereby authorize the Company to use, reuse, and to grant others the right to use and reuse, my name, photograph, likeness (including caricature), voice, and biographical information, and any reproduction or simulation thereof, in any form of media or technology now known or hereafter developed (including, but not limited to, film, video and digital or other electronic media), both during and after my employment, for any

purposes related to the Company's business, such as marketing, advertising, credits, and presentations.

15. Injunctive Relief. I understand that in the event of a breach or threatened breach of this Agreement by me the Company may suffer irreparable harm and will therefore be entitled to injunctive relief to enforce this Agreement.

16. Governing Law; Severability. This Agreement will be governed by and construed in accordance with the laws of the State of California, without giving effect to its laws pertaining to conflict of laws. If any provision of this Agreement is determined by any court or arbitrator of competent jurisdiction to be invalid, illegal or unenforceable in any respect, such provision will be enforced to the maximum extent possible given the intent of the parties hereto. If such clause or provision cannot be so enforced, such provision shall be stricken from this Agreement and the remainder of this Agreement shall be enforced as if such invalid, illegal or unenforceable clause or provision had (to the extent not enforceable) never been contained in this Agreement.

17. Counterparts. This Agreement may be executed in any number of counterparts, each of which when so executed and delivered will be deemed an original, and all of which together shall constitute one and the same agreement.

18. Entire Agreement. This Agreement and the documents referred to herein constitute the entire agreement and understanding of the parties with respect to the subject matter of this Agreement, and supersede all prior understandings and agreements, whether oral or written, between or among the parties hereto with respect to the specific subject matter hereof.

19. Amendment and Waivers. This Agreement may be amended only by a written agreement executed by each of the parties hereto. No amendment or waiver of, or modification of any obligation under this Agreement will be enforceable unless set forth in a writing signed by the party against which enforcement is sought. Any amendment effected in accordance with this section will be binding upon all parties hereto and each of their respective successors and assigns. No delay or failure to require performance of any provision of this Agreement shall constitute a waiver of that provision as to that or any other instance. No waiver granted under this Agreement as to any one provision herein shall constitute a subsequent waiver of such provision or of any other provision herein, nor shall it constitute the waiver of any performance other than the actual performance specifically waived.

20. Successors and Assigns; Assignment. Except as otherwise provided in this Agreement, this Agreement, and the rights and obligations of the parties hereunder, will be binding upon and inure to the benefit of their respective successors, assigns, heirs, executors, administrators and legal representatives. The Company may assign any of its rights and obligations under this Agreement. No other party to this Agreement may assign, whether voluntarily or by operation of law, any of its rights and obligations under this Agreement, except with the prior written consent of the Company.

21. Further Assurances. The parties agree to execute such further documents and instruments and to take such further actions as may be reasonably necessary to carry out the purposes and intent of this Agreement.

22. "At Will" Employment. I understand that this Agreement does not constitute a contract of employment or obligate the Company to employ me for any stated period of time. I understand that I am an "at will" employee of the Company and that my employment can be terminated at any time, with or without notice and with or without cause, for any reason or for no reason, by either the Company or myself. I acknowledge that any statements or representations to the contrary are ineffective, unless put into a writing signed by the Company. I further acknowledge that my participation in any stock option or benefit program is not to be construed as any assurance of continuing employment for any particular period of time. This, Agreement shall be effective as of the first day of my employment by the Company, which is March 21, 2006.

* * * * *

In Witness Whereof, the parties have executed this Agreement as of the 21st day of March, 2006.

PVI Solutions, Inc.:

By: /s/ Martin Fornage

Name: Martin Fornage

Title: Secretary

Employee:

/s/ Raghuveer Belur
Signature

Raghuveer Belur
Name (Please Print)

Signature Page to Employee Invention Assignment and Confidentiality Agreement

AMENDMENT TO EMPLOYMENT AGREEMENT

This Amendment (this "**Amendment**") to that certain Employment Agreement dated as of March 21, 2006 (the "**Agreement**") between PVI Solutions, Inc., a Delaware corporation with its principal offices located at 101 2nd Street, Suite 110, Petaluma, CA 94952 (the "**Company**"), and Raghuv eer R. Belur, a resident of California (the "**Employee**") is entered into as of January 23, 2007.

WHEREAS, pursuant to the Agreement, Employee has served the Company in the capacity of President and Chief Executive Officer.

WHEREAS, in connection with the Series B Preferred Stock financing of the Company, Employee has agreed to serve on the Company's Board of Directors and as Vice President Marketing and to cease serving as the Company's President and Chief Executive Officer.

WHEREAS, the Company has determined that it is in the best interests of the Company to change Employee's base salary, effective upon the receipt of minimum aggregate gross proceeds to the Company of Four Million Dollars (\$4,000,000) in connection with a Series B Preferred Stock offering (the "**Series B Date**").

NOW, THEREFORE, the parties agree as follows:

1. Section 1 of the Agreement is hereby amended and restated as follows:

"Position. During the term of this Agreement, Company will employ Employee, and Employee will serve Company in the capacity of Vice President Marketing. Employee will report directly to the Company's Chief Executive Officer."

The parties acknowledge and agree that the change in Employee's position effected by this Amendment shall not constitute a Constructive Termination or Termination without Cause under the Agreement.

2. Section 5.1 of the Agreement is hereby amended and restated as follows as of the Series B Date:

"Base Salary. The Company agrees to pay Employee a minimum annual salary of one hundred and forty thousand dollars (\$140,000), or in the event of any portion of a year, a pro rata amount of such annual salary. Employee's base salary shall be reviewed by the Board of Directors for possible increases prior to the start of each fiscal year, effective at the beginning of such fiscal year. Employee's salary will be payable as earned in accordance with Company's customary payroll practice."

3. Capitalized terms not defined herein have the meanings set forth in the Agreement. Except as set forth herein, the Agreement, as amended hereby, remains in full force and effect.

IN WITNESS WHEREOF, the Company and Employee have executed this Amendment as of the date first above written.

“COMPANY”

“EMPLOYEE”

/s/ Paul Nahi

/s/ Raghuveer R. Belur

By: Paul Nahi

By: Raghuveer R. Belur

Signature Page to Employment Agreement

ENPHASE ENERGY, INC.

AMENDMENT NO. 2 TO EMPLOYMENT AGREEMENT

This Amendment No. 2 (this "Amendment") to that certain Employment Agreement dated as of March 21, 2006, as amended on January 23, 2007 (as amended, the "Agreement") between Enphase Energy, Inc., formerly known as PVI Solutions, Inc., a Delaware corporation with its principal offices located at 201 1st Street, Suite 111, Petaluma, California 94952 (the "Company"), and Raghuvveer R. Belur, a resident of California (the "Employee") is entered into as of April 16, 2008.

WHEREAS, in connection with the Series C Preferred Stock financing of the Company, Employee has agreed to a change in the terms of his severance compensation.

NOW, THEREFORE, the parties agree as follows:

1. Section 8.4(b) of the Agreement is hereby amended and restated as follows:

"(b) for six (6) months after the termination of Employee's employment the Company shall continue to pay Employee (A) his salary under Section 5.1 at Employee's then-current salary, less applicable withholding taxes, payable on the Company's normal payroll dates during that period, (B) his annual cash bonus, if any, under Section 5.2 above, and (C) shall continue his benefits under Section 5.3 above, and"

2. Capitalized terms not defined herein have the meanings set forth in the Agreement. Except as set forth herein, the Agreement, as amended hereby, remains in full force and effect.

[Signature Page Follows]

IN WITNESS WHEREOF, the Company and Employee have executed this Amendment as of the date first above written.

“COMPANY”

“EMPLOYEE”

ENPHASE ENERGY, INC.

RAGHUVVEER R. BELUR

By: /s/ Paul Nahi

By: /s/ Raghuveer R. Belur

Name: Paul Nahi
Title: President & CEO

SIGNATURE PAGE TO AMENDMENT NO. 2 TO EMPLOYMENT AGREEMENT

ENPHASE ENERGY, INC.

AMENDMENT NO. 3 TO EMPLOYMENT AGREEMENT

This Amendment No. 3 (this "Amendment") to that certain Employment Agreement dated as of March 21, 2006, as amended on January 23, 2007 and April 16, 2008 (as amended, the "Agreement") between Enphase Energy, Inc., formerly know as PVI Solutions, Inc., a Delaware corporation with its principal offices located at 201 1st Street, Suite 111, Petaluma, California 94952 (the "Company"), and Raghuvveer R. Belur, a resident of California (the "Employee") is entered into as of December 21, 2008.

WHEREAS, the Company and the Employee have agreed to amend the Agreement to clarify certain existing provisions in light of final regulations issued under Section 409A of the Internal Revenue Code of 1986, as amended.

NOW, THEREFORE, the parties agree as follows:

1. Section 5.2 of the Agreement is hereby amended and restated as follows:

"**5.2 Cash Bonus.** Employee will be eligible to receive an annual cash bonus in the discretion of the Board of Directors. A bonus will not be earned unless and until the Board of Directors makes such determination. If the Board of Directors determines that Employee will receive an annual bonus, the bonus will be paid to Employee within 60 days following the date of the Board of Directors' determination."

2. Section 5.5 of the Agreement is hereby amended and restated as follows:

"**5.5. Expenses.** The Company will reimburse Employee for all reasonable and necessary expenses incurred by Employee in connection with the Company's business, provided that such expenses are in accordance with applicable policy set by the Board from time to time and are properly documented and accounted for in accordance with the policy of the Company and with the requirements of the Internal Revenue Service. To the extent that any expense reimbursements are subject to the provisions of Section 409A of the Internal Revenue Code of 1986, as amended (the "**Code**"), such reimbursements will be paid no later than December 31 of the year following the year in which the reimbursable expenses are incurred, the amount of expenses reimbursed in one year will not affect the amount eligible for reimbursement in any subsequent year, and the right to reimbursement will not be subject to liquidation or exchange for another benefit."

3. Section 7.1(d) of the Agreement is hereby amended and restated as follows:

"(d) thirty (30) days following the date of a written notice sent to the Company by Employee stating the circumstances giving rise to a "Constructive Termination," as defined under Section 7.3 below ("**Constructive Termination**"), provided that such notice is delivered to the Company within ninety (90) days of the initial existence of the circumstances giving rise to a Constructive Termination and the Company is provided

with an opportunity to cure the circumstances giving rise to a Constructive Termination within the thirty (30) day notice period and fails to do so.”

4. Section 7.3(a) of the Agreement is hereby amended and restated as follows:

“(a) a material reduction in Employee’s salary not agreed to by Employee: or”

5. Section 7.3(c) of the Agreement is hereby amended and restated as follows:

“(c) the Company’s failure to comply in any material respect with any material term of this Agreement, which shall include a material reduction in the type or level of benefits set forth in Section 5.3. not agreed to by Employee: or”

6. The first sentence of Section 8.2 of the Agreement is hereby amended and restated as follows:

“8.2 **Termination for Disability**. In the event of termination of employment pursuant to Section 7.1 (b) and provided that such termination constitutes a “separation from service” (as such term is defined in Section 409A of the Code):”

7. Section 8.2(b) of the Agreement is hereby amended and restated as follows:

“(b) for six (6) months after the termination of Employee’s employment, the Company shall continue to pay (A) Employee’s salary under Section 5.1 above at Employee’s then current salary, less applicable withholding taxes, payable on the Company’s normal payroll dates during that period, (B) Employee’s annual cash bonus, under Section 5.2 above, and (C) the premiums for Employee’s continued medical and any other applicable health insurance coverage under COBRA subject to Employee’s timely election of COBRA coverage, Employee’s continued eligibility for participation and subject to COBRA’s terms, conditions and restrictions: and”

8. The first sentence of Section 8.4 of the Agreement is hereby amended and restated as follows:

“8.4 **Constructive Termination or Termination Without Cause**. In the event of any termination of this Agreement pursuant to Section 7.1(d) or Section 7.1(e) and provided that such termination constitutes a “separation from service” (as defined in Section 409A of the Code).”

9. Section 8.4(b) of the Agreement is hereby amended and restated as follows:

“(b) for six (6) months after the termination of Employee’s employment, the Company shall continue to pay (A) Employee’s salary under Section 5.1 above at Employee’s then current salary, less applicable withholding taxes, payable on the Company’s normal payroll dates during that period. (B) Employee’s annual cash bonus, under Section 5.2 above, and (C) the premiums for Employee’s continued medical and

any other applicable health insurance coverage under COBRA subject to Employee's timely election of COBRA coverage. Employee's continued eligibility for participation and subject to COBRA's terms, conditions and restrictions: and"

10. A new Section 9.14 of the Agreement is hereby added as follows:

"9.14 Compliance with Section 409A. All severance payments to be made upon a termination of employment under this Agreement may be made only upon a "separation of service" within the meaning of Section 409A of the Code and the Department of Treasury regulations and other guidance promulgated thereunder. Notwithstanding any provision to the contrary in this Agreement, if Employee is deemed by the Company at the time of Employee's separation from service to be a "specified employee" for purposes of Code Section 409A(a)(2)(B)(i), to the extent delayed commencement of any portion of the benefits to which Employee is entitled under this Agreement is required in order to avoid a prohibited distribution under Code Section 409A(a)(2)(B)(i), such portion of Employee's benefits shall not be provided to Employee prior to the earlier of (i) the expiration of the six-month period measured from the date of Employee's "separation from service" with the Company or (ii) the date of Employee's death. Upon the first business day following the expiration of the applicable Code Section 409A(a)(2)(B)(i) period, all payments deferred pursuant to this Section 9.14 shall be paid in a lump sum to Employee, and any remaining payments due under the Agreement shall be paid as otherwise provided herein. For purposes of Code Section 409A (including, without limitation, for purposes of Treasury Regulation Section 1.409A-2(b)(2)(iii)). Employee's right to receive installment payments under this Agreement shall be treated as a right to receive a series of separate payments and, accordingly, each installment payment hereunder shall at all times be considered a separate and distinct payment. It is intended that all of the severance payments satisfy, to the greatest extent possible, the exemptions from the application of Code Section 409A provided under of Treasury Regulation 1.409A-1(b)(4), 1.409A-1(b)(5) and 1.409A-1(b)(9), and this Agreement will be construed to the greatest extent possible as consistent with those provisions."

11. Capitalized terms not defined herein have the meanings set forth in the Agreement. Except as set forth herein, the Agreement, as amended hereby, remains in full force and effect.

[Signature Page Follows]

IN WITNESS WHEREOF, the Company and Employee have executed this Amendment as of the date first above written.

“COMPANY”

ENPHASE ENERGY, INC.

By: /s/ Paul Nahi

Name Paul Nahi

Title: CEO

“EMPLOYEE”

RAGHUVVEER R. BELUR

By: /s/ Raghuveer R. Belur

AMENDED AND RESTATED
VENTURE LOAN AND SECURITY AGREEMENT

Originally Dated March 11, 2010
Amended and Restated as of March 25, 2011

by and between

HORIZON TECHNOLOGY FINANCE CORPORATION,
a Delaware corporation
76 Batterson Park Road
Farmington, CT 06032

as Lender

HORIZON CREDIT I LLC
a Delaware limited liability company
76 Batterson Park Road
Farmington, CT 06032

as Assignee and Holder of Advance (Loan A)

And

ENPHASE ENERGY, INC.,
a Delaware corporation
201 1st Street, Suite 300
Petaluma, CA 94952

as Borrower

Commitment Amount (Loan A): \$7,000,000

Commitment Amount (Loan B): \$2,000,000

Commitment Amount (Loan C): \$3,000,000

Commitment Termination Date (Loan A): March 19, 2010

Commitment Termination Date (Loan B): March 31, 2011

Commitment Termination Date (Loan C): July 31, 2011

The Lender and Borrower hereby agree as follows:

AGREEMENT

1. Definitions and Construction.

1.1 Definitions. As used in this Agreement, the following capitalized terms shall have the following meanings:

“Account Control Agreement” means an agreement acceptable to Lender which perfects via control Lender’s security interest in Borrower’s deposit accounts and/or accounts holding securities.

“Advance” means any advance of credit by Lender to the Borrower under this Agreement, and “Advances” means, collectively, all such Advances.

“Advance (Loan A)” means the single Advance under the Loan Facility (Loan A) to the Borrower under this Agreement.

“Advance (Loan B)” means the single Advance under the Loan Facility (Loan B) to the Borrower under this Agreement.

“Advance (Loan C)” means the single Advance under the Loan Facility (Loan C) to the Borrower under this Agreement.

“Advance (Loan A) Scheduled Payments” has the meaning given such term in Section 2.2(a) of this Agreement.

“Advance (Loan B) Scheduled Payments” has the meaning given such term in Section 2.2(b) of this Agreement.

“Advance (Loan C) Scheduled Payments” has the meaning given such term in Section 2.2(c) of this Agreement.

“Affiliate” means any Person that owns or controls directly or indirectly ten percent (10%) or more of the stock of another entity, any Person that controls or is controlled by or is under common control with such Persons or any Affiliate of such Persons and each of such Person’s officers, directors, joint venturers or partners.

“Agreement” means this certain Amended and Restated Venture Loan and Security Agreement by and between Borrower and Lender dated as of the date on the cover page hereto (as it may from time to time be amended or supplemented in writing signed by the Borrower and Lender).

“Account” has the meaning given such term in Section 7.13 of this Agreement.

“Borrower” means the Borrower as set forth on the cover page of this Agreement.

“Business Day” means any day that is not a Saturday, Sunday, or other day on which banking institutions are authorized or required to close in Connecticut or California.

“Claim” has the meaning given such term in Section 10.3 of this Agreement

“Code” means the Uniform Commercial Code as adopted and in effect in the State of Connecticut, as amended from time to time; provided that if by reason of mandatory provisions of law, the creation and/or perfection or the effect of perfection or non-perfection of the security interest in any Collateral is governed by the Uniform Commercial Code as in effect in a jurisdiction other than Connecticut, the term “Code” shall also mean the Uniform Commercial Code as in effect from time to time in such jurisdiction for purposes of the provisions hereof relating to such creation, perfection or effect of perfection or non-perfection.

“Collateral” has the meaning given such term in Section 4.1 of this Agreement.

“Commitment Amount” means, collectively, Commitment Amount (Loan A), Commitment Amount (Loan B) and Commitment Amount (Loan C).

“Commitment Amount (Loan A)” has the meaning as set forth on the cover page of this Agreement.

“Commitment Amount (Loan B)” has the meaning as set forth on the cover page of this Agreement.

“Commitment Amount (Loan C)” has the meaning set forth on the cover page of this Agreement.

“Commitment Fee” has the meaning given such term in Section 2.6(c) of this Agreement.

“Commitment Termination Date” means, as applicable, the Commitment Termination Date (Loan A), the Commitment Termination Date (Loan B) or the Commitment Termination Date (Loan C).

“Commitment Termination Date (Loan A)” has the meaning set forth on the cover page of this Agreement.

“Commitment Termination Date (Loan B)” has the meaning set forth on the cover page of this Agreement.

“Commitment Termination Date (Loan C)” has the meaning set forth on the cover page of this Agreement

“Contingent Obligation” means, as applied to any Person, any direct or indirect liability, contingent or otherwise, of that Person with respect to (i) any indebtedness, lease, dividend, letter of credit or other obligation of another; (ii) any obligations with respect to undrawn letters of credit, corporate credit cards, or merchant services issued or provided for the account of that

Person; and (iii) all obligations arising under any agreement or arrangement designed to protect such Person against fluctuation in interest rates, currency exchange rates or commodity prices; provided, however, that the term "Contingent Obligation" shall not include endorsements for collection or deposit in the ordinary course of business. The amount of any Contingent Obligation shall be deemed to be an amount equal to the stated or determined amount of the primary obligation in respect of which such Contingent Obligation is made or, if not stated or determinable, the maximum reasonably anticipated liability in respect thereof as determined by Lender in good faith; provided, however, that such amount shall not in any event exceed the maximum amount of the obligations under the guarantee or other support arrangement.

"Default" means any event which with the passing of time or the giving of notice or both would become an Event of Default hereunder.

"Default Rate" means the per annum rate of interest equal to five percent (5%) over the applicable Loan Rate, but such rate shall in no event be more than the highest rate permitted by applicable law to be charged on commercial loans in a default situation.

"Disclosure Schedule" means the Disclosure Letter provided by Borrower to Lender on or about the date hereof.

"Environmental Laws" means all foreign, federal, state or local laws, statutes, common law duties, rules, regulations, ordinances and codes, together with all administrative orders, directed duties, requests, licenses, authorizations and permits of, and agreements with, any Governmental Authorities, in each case relating to environmental, health, safety and land use matters, including the Comprehensive Environmental Response, Compensation and Liability Act of 1980, the Clean Air Act, the Federal Water Pollution Control Act of 1972, the Solid Waste Disposal Act, the Federal Resource Conservation and Recovery Act, the Toxic Substances Control Act and the Emergency Planning and Community Right-to-Know Act.

"Equipment" means all present and future machinery, equipment, tenant improvements, furniture, fixtures, vehicles, tools, parts and attachments in which Borrower has any interest.

"Equity Securities" of any Person means (a) all common stock, preferred stock, participations, shares, partnership interests, membership interests or other equity interests in and of such Person (regardless of how designated and whether or not voting or non-voting) and (b) all warrants, options and other rights to acquire any of the foregoing.

"ERISA" has the meaning given to such term in Section 7.12 of this Agreement.

"Event of Default" has the meaning given to such term in Section 8 of this Agreement.

"Foreign Accounts" has the meaning given such term in Section 7.13 of this Agreement.

"French Account" has the meaning given such term in Section 7.13 of this Agreement.

"Funding Certificate" means a certificate executed by a Responsible Officer of Borrower substantially in the form of Exhibit B or such other form as Lender may agree to accept.

“Funding Date” means any date on which an Advance is made to or on account of Borrower under this Agreement.

“GAAP” means generally accepted accounting principles as in effect in the United States of America from time to time, consistently applied.

“Good Faith Deposit” has the meaning given such term in Section 2.6(a) of this Agreement.

“Governmental Authority” means (a) any federal, state, county, municipal or foreign government, or political subdivision thereof, (b) any governmental or quasi-governmental agency, authority, board, bureau, commission, department, instrumentality or public body, (c) any court or administrative tribunal, or (d) with respect to any Person, any arbitration tribunal or other non-governmental authority to whose jurisdiction that Person has consented.

“Hazardous Materials” means all those substances which are regulated by, or which may form the basis of liability under, any Environmental Law, including all substances identified under any Environmental Law as a pollutant, contaminant, hazardous waste, hazardous constituent, special waste, hazardous substance, hazardous material, or toxic substance, or petroleum or petroleum derived substance or waste.

“Indebtedness” means (a) all indebtedness for borrowed money or the deferred purchase price of property or services (excluding trade payables aged less than one hundred eighty (180) days), including without limitation reimbursement and other obligations with respect to surety bonds and letters of credit, (b) all obligations evidenced by notes, bonds, debentures or similar instruments, (c) all capital lease obligations and (d) all Contingent Obligations.

“Indemnified Person” has the meaning given such term in Section 10.3 of this Agreement.

“Intellectual Property” means all of Borrower’s right, title and interest in and to patents, patent rights (and applications and registrations therefor and divisions, continuations, renewals, reissues, extensions and continuations-in-part of the same), trademarks and service marks (and applications and registrations therefor and the goodwill associated therewith), inventions, copyrights (including applications and registrations therefor and like protections in each work or authorship and derivative work thereof), mask works (and applications and registrations therefor), trade names, trade styles, software and computer programs, source code, object code, trade secrets, methods, processes, know how, drawings, specifications, descriptions, and all memoranda, notes, and records with respect to any research and development, all whether now owned or subsequently acquired or developed by Borrower and all licenses to use the foregoing, whether in tangible or intangible form or contained on magnetic media readable by machine together with all such magnetic media (but not including embedded computer programs and supporting information included within the definition of “goods” under the Code).

“Inventory” means all inventory in which Borrower has or acquires any interest, including work in process and finished products intended for sale or lease or to be furnished under a contract of service, of every kind and description now or at any time hereafter owned by or in the custody or possession, actual or constructive, of Borrower, including such inventory as

is temporarily out of its custody or possession or in transit and including any returns upon any accounts or other proceeds, including insurance proceeds, resulting from the sale or disposition of any of the foregoing and any documents of title representing any of the above, and Borrower's books relating to any of the foregoing.

"Investment" means the purchase or acquisition of any capital stock, equity interest, or any obligations or other securities of, or any interest in, any Person, or the extension of any advance, loan, extension of credit (excluding inter-company trade payables aged less than one hundred eighty (180) days) or capital contribution to, or any other investment in, or deposit with, any Person.

"Italian Account" has the meaning given such term in Section 7.13 of this Agreement.

"Landlord Agreement" means an agreement substantially in the form provided by Lender to Borrower or such other form as Lender may agree to accept.

"Lender" means the Lender as set forth on the cover page of this Agreement.

"Lender's Expenses" means all reasonable costs or expenses (including reasonable attorneys' fees and expenses) incurred in connection with the preparation, negotiation, documentation, administration and funding of the Loan Documents; and Lender's reasonable attorneys' fees, costs and expenses incurred in amending, modifying, enforcing or defending the Loan Documents (including fees and expenses of appeal or review), including the exercise of any rights or remedies afforded hereunder or under applicable law, whether or not suit is brought, whether before or after bankruptcy or insolvency, including without limitation all fees and costs incurred by Lender in connection with Lender's enforcement of its rights in a bankruptcy or insolvency proceeding filed by or against Borrower or its Property.

"Lien" means any voluntary or involuntary security interest, pledge, bailment, lease, mortgage, hypothecation, conditional sales and title retention agreement, encumbrance or other lien with respect to any Property in favor of any Person.

"Loan" means the advance of credit by Lender to Borrower pursuant to the Advance (Loan A), the Advance (Loan B) and the Advance (Loan C) under this Agreement, and "Loans" means collectively all such Advances.

"Loan Documents" means, collectively, this Agreement, each Note, each Warrant, any Landlord Agreement, any Account Control Agreement and all other documents, instruments and agreements entered into in connection with this Agreement, all as amended or extended from time to time.

"Loan Facility (Loan A)" means Lender's obligation to fund the Advance (Loan A) hereunder in an aggregate outstanding principal amount not to exceed the Commitment Amount (Loan A).

"Loan Facility (Loan B)" means Lender's obligation to fund the Advance (Loan B) hereunder in an aggregate outstanding principal amount not to exceed the Commitment Amount (Loan B).

“Loan Facility (Loan C)” means Lender’s obligation to fund the Advance (Loan C) hereunder in an aggregate outstanding principal amount not to exceed the Commitment Amount (Loan C).

“Loan Rate” shall mean, as applicable, Loan Rate (Loan A), Loan Rate (Loan B) or Loan Rate (Loan C) as applicable.

“Loan Rate (Loan A)” means the fixed per annum rate of interest (based on a year of twelve 30-day months) equal to 12.60%.

“Loan Rate (Loan B)” means the fixed per annum rate of interest (based on a year of twelve 30-day months) equal to the greater of (a) 10.75% or (b) 10.75% plus the difference between (i) the one month LIBOR Rate (rounded to the nearest one hundredth percent), as reported in the Wall Street Journal, on the date which is five (5) Business Days before the Funding Date for Advance (Loan B) (or, if the Wall Street Journal is not published on such date, the next earlier date on which it is published) and (ii) 0.30%.

“Loan Rate (Loan C)” means the fixed per annum rate of interest (based on a year of twelve 30-day months) equal to the greater of (a) 10.75% or (b) 10.75% plus the difference between (i) the one month LIBOR Rate (rounded to the nearest one hundredth percent), as reported in the Wall Street Journal, on the date which is five (5) Business Days before the Funding Date for Advance (Loan C) (or, if the Wall Street Journal is not published on such date, the next earlier date on which it is published) and (ii) 0.30%.

“Maturity Date (Loan A)” means October 1, 2013, or if earlier, the date of acceleration of Advance (Loan A) following an Event of Default or the date of prepayment, whichever is applicable.

“Maturity Date (Loan B)” means October 1, 2014, or if earlier, the date of acceleration of Advance (Loan B) following an Event of Default or the date of prepayment, whichever is applicable.

“Maturity Date (Loan C)” means the first calendar day of the month that follows the Forty-Two (42) month anniversary of the Funding Date of Advance (Loan C), or if earlier, the date of acceleration of Advance (Loan C) following an Event of Default or the date of prepayment, whichever is applicable.

“Note” means each promissory note executed in connection with the Loans in substantially the form of Exhibit C attached hereto, and collectively, “Notes” means all such promissory notes.

“Obligations” means all debt, principal, interest, fees, charges, expenses and attorneys’ fees and costs and other amounts, obligations, covenants, and duties owing by Borrower to Lender of any kind and description (whether pursuant to or evidenced by the Loan Documents (other than the Warrant), or by any other agreement between Lender and Borrower, and whether or not for the payment of money), whether direct or indirect, absolute or contingent, due or to become due, now existing or hereafter arising, including all Lender’s Expenses.

“Officer’s Certificate” means a certificate executed by a Responsible Officer substantially in the form of Exhibit E or such other form as Lender may agree to accept.

“Payment Date” has the meaning given such term in Section 2.2(a) of this Agreement.

“Permitted Indebtedness” means and includes:

- (a) Indebtedness of Borrower to Lender;
- (b) Indebtedness arising from the endorsement of instruments in the ordinary course of business;
- (c) Indebtedness existing on the date hereof and set forth on the Disclosure Schedule;

(d) Indebtedness in an aggregate principal amount not exceeding Thirty Million Dollars (\$30,000,000), consisting of a revolving credit facility from Bridge Bank, N.A. and Comerica Bank and in which the loans are limited to not more than Eighty Percent (80%) of Borrower’s outstanding accounts receivable and Fifty Percent (50%) of Borrower’s eligible inventory;

(e) Indebtedness secured by a lien described in clause (g) of the defined term “Permitted Liens,” provided (i) such Indebtedness does not exceed the lesser of the cost or fair market value of the equipment financed with such Indebtedness and (ii) such Indebtedness does not exceed Five Million Dollars (\$5,000,000) in the aggregate at any given time; and

(f) Indebtedness to Oracle America, Inc. or one of its affiliates, including Oracle Credit Corporation in an aggregate amount not to exceed \$500,000;

(g) Inter-company Indebtedness incurred in the ordinary course of business;

(h) Other Indebtedness in an aggregate amount not exceeding Seven Hundred Fifty Thousand Dollars (\$750,000) at any time;

(i) Subordinated Debt; and

(j) extensions, refinancings, modifications, amendments and restatements of any items of Permitted Indebtedness (a) through (i) above, provided that the principal amount thereof is not increased or the terms thereof are not modified to impose more burdensome terms upon Borrower or its Subsidiary, as the case may be.

“Permitted Investments” means and includes any of the following Investments as to which Lender has a perfected security interest:

(a) Deposits and deposit accounts with commercial banks organized under the laws of the United States or a state thereof to the extent: (i) the deposit accounts of each such institution are insured by the Federal Deposit Insurance Corporation up to the legal limit; and (ii)

each such institution has an aggregate capital and surplus of not less than One Hundred Million Dollars (\$100,000,000);

(b) Investments made in accordance with Borrower's board approved short term investment policy;

(c) Investments in marketable obligations issued or fully guaranteed by the United States and maturing not more than one (1) year from the date of issuance;

(d) Investments in open market commercial paper rated at least "A1" or "P1" or higher by a national credit rating agency and maturing not more than one (1) year from the creation thereof;

(e) Investments pursuant to or arising under currency agreements or interest rate agreements entered into in the ordinary course of business;

(f) Investments consisting of (i) travel advances and employee relocation loans and other employee loans and advances in the ordinary course of business, and (ii) loans to employees, officers or directors relating to the purchase of equity securities of Borrower or its Subsidiaries pursuant to employee stock purchase plans or agreements approved by Borrower's Board of Directors; not to exceed Two Hundred Fifty Thousand Dollars (\$250,000) in the aggregate in any fiscal year;

(g) Investments (including debt obligations) received in connection with the bankruptcy or reorganization of customers or suppliers and in settlement of delinquent obligations of, and other disputes with, customers or suppliers arising in the ordinary course of business;

(h) Investments consisting of notes receivable of, or prepaid royalties and other credit extensions, to customers and suppliers who are not Affiliates, in the ordinary course of business; provided that this paragraph (g) shall not apply to Investments of Borrower in any Subsidiary;

(i) Investments in Subsidiaries made in the ordinary course of business, not to exceed Four Million Five Hundred Thousand and 00/100 Dollars (\$4,500,000) in the aggregate in any fiscal year;

(j) (x) joint ventures or strategic alliances in the ordinary course of Borrower's business consisting of the nonexclusive licensing of technology, the development of technology or the providing of technical support, provided that any cash investments by Borrower do not exceed Five Hundred Thousand Dollars (\$500,000) in the aggregate in any fiscal year; and (y) strategic alliances with particular customers in which such customers will share in the research and development expense of Borrower associated with the incorporation by such customers of microconverters purchased from Borrower into solar panels produced by such customers; and

(k) Other Investments aggregating not in excess of Two Hundred Fifty Thousand Dollars (\$250,000) at any time.

“Permitted Liens” means and includes:

(a) the Lien created by this Agreement;

(b) Liens for fees, taxes, levies, imposts, duties or other governmental charges of any kind which are not yet delinquent or which are being contested in good faith by appropriate proceedings which suspend the collection thereof (provided that such appropriate proceedings do not involve any substantial danger of the sale, forfeiture or loss of any material item of Collateral which in the aggregate is material to Borrower and that Borrower has adequately bonded such Lien or reserves sufficient to discharge such Lien have been provided on the books of Borrower);

(c) Liens identified on the Disclosure Schedule;

(d) carriers’, warehousemen’s, mechanics’, materialmen’s, repairmen’s or other similar Liens arising in the ordinary course of business and which are not delinquent or remain payable without penalty or which are being contested in good faith and by appropriate proceedings (“provided that such appropriate proceedings do not involve any substantial danger of the sale, forfeiture or loss of any material item of Collateral or Collateral which in the aggregate is material to Borrower and that Borrower has adequately bonded such Lien or reserves sufficient to discharge such Lien have been provided on the books of Borrower);

(e) Liens granted in connection with Indebtedness permitted under subsection (d) of the definition of Permitted Indebtedness; provided that such liens shall be subject to an intercreditor agreement between Bridge Bank, N.A., Comerica Bank and Lender;

(f) non-exclusive licenses of Intellectual Property entered into in the ordinary course of business, and licenses of Intellectual Property that could not result in a legal transfer of title of the licensed property that may be exclusive in respects other than territory and that may be exclusive as to territory only as to discreet geographical areas outside of the United States.

(g) Liens (i) upon or in any equipment which was not financed by Lender acquired or held by Borrower or any of its Subsidiaries to secure the purchase price of such equipment or indebtedness incurred solely for the purpose of financing the acquisition of such equipment, or (ii) existing on such equipment at the time of its acquisition, provided that the Lien is confined solely to the property so acquired and improvements thereon, and the proceeds of such equipment;

(h) Liens to secure payment of workers’ compensation, employment insurance, old-age pensions, social security and other like obligations incurred in the ordinary course of business (other than Liens imposed by ERISA);

(i) Liens arising from attachments or judgments, orders, or decrees in circumstances not constituting an Event of Default under Sections 8.5 and 8.8;

(j) Liens in favor of customs and revenue authorities incurred in the ordinary course of business to secure payment of custom duties in connection with the importation of goods;

(k) leases or subleases of real property granted in the ordinary course of Borrower's business (or, if referring to another Person, in the ordinary course of such Person's business), and leases, subleases, non-exclusive licenses or sublicenses of personal property (other than Intellectual Property) granted in the ordinary course of Borrower's business (or, if referring to another Person, in the ordinary course of such Person's business), if the leases, subleases, licenses and sublicenses do not prohibit granting a security interest therein; and

(1) Liens incurred in connection with the extension, renewal or refinancing of the indebtedness secured by Liens of the type described in clauses (a) through (k) above, provided that any extension, renewal or replacement Lien shall be limited to the property encumbered by the existing Lien and the principal amount of the indebtedness being extended, renewed or refinanced does not increase;

“Person” means and includes any individual, any partnership, any corporation, any business trust, any joint stock company, any limited liability company, any unincorporated association or any other entity and any domestic or foreign national, state or local government, any political subdivision thereof, and any department, agency, authority or bureau of any of the foregoing.

“Property” means any interest in any kind of property or asset, whether real, personal or mixed, whether tangible or intangible.

“Responsible Officer” has the meaning given such term in Section 6.3 of this Agreement.

“Scheduled Payments” shall mean collectively, the Advance (Loan A) Scheduled Payments, the Advance (Loan B) Scheduled Payments and the Advance (Loan C) Scheduled Payments.

“Solvent” has the meaning given such term in Section 5.11 of this Agreement.

“Subordinated Debt” means any debt incurred by Borrower that is subordinated to the debt owing by Borrower to Lender hereunder or under any of the Loan Documents on terms acceptable to Lender (and identified as being such by Borrower and Lender).

“Subsidiary” means any corporation or other entity of which a majority of the outstanding Equity Securities entitled to vote for the election of directors or other governing body (otherwise than as the result of a default) is owned by Borrower directly or indirectly through Subsidiaries, including without limitation Enphase Energy SAS and Enphase Energy SRL.

“Third Party Equipment” has the meaning given such term in Section 4.8 of this Agreement.

“Transfer” has the meaning given such term in Section 7.4 of this Agreement.

“Warrant A” means the warrant to purchase Equity Securities of Borrower granted to Lender on or about the date of the Advance (Loan A), and any replacement warrants issued in connection therewith.

“Warrant B” means the warrant to purchase Equity Securities of Borrower granted to Lender on or about the date hereof, and any replacement warrants issued in connection therewith.

“Warrants” means collectively, Warrant A and Warrant B.

1.2 Construction. This Agreement amends and restates that certain Venture Loan and Security Agreement dated as of March 11, 2010 by and between Lender and Borrower. References in this Agreement to “Articles,” “Sections,” “Exhibits,” “Schedules” and “Annexes” are to recitals, articles, sections, exhibits, schedules and annexes herein and hereto unless otherwise indicated. References in this Agreement and each of the other Loan Documents to any document, instrument or agreement shall include (a) all exhibits, schedules, annexes and other attachments thereto, (b) all documents, instruments or agreements issued or executed in replacement thereof, and (c) such document, instrument or agreement, or replacement or predecessor thereto, as amended, modified and supplemented from time to time and in effect at any given time. The words “hereof,” “herein” and “hereunder” and words of similar import when used in this Agreement or any other Loan Document shall refer to this Agreement or such other Loan Document, as the case may be, as a whole and not to any particular provision of this Agreement or such other Loan Document, as the case may be. The words “include” and “including” and words of similar import when used in this Agreement or any other Loan Document shall not be construed to be limiting or exclusive. Unless otherwise indicated in this Agreement or any other Loan Document, all accounting terms used in this Agreement or any other Loan Document shall be construed, and all accounting and financial computations hereunder or thereunder shall be computed, in accordance with GAAP, and all terms describing Collateral shall be construed in accordance with the Code. The terms and information set forth on the cover page of this Agreement are incorporated into this Agreement.

2. Loans; Repayment.

2.1 Commitment.

(a) The Commitment Amount (Loan A). Subject to the terms and conditions of this Agreement and relying upon the representations and warranties herein set forth as and when made or deemed to be made, Lender agrees to lend to Borrower prior to the Commitment Termination Date (Loan A), one Advance in an aggregate amount not to exceed the Commitment Amount (Loan A).

(b) The Commitment Amount (Loan B). Subject to the terms and conditions of this Agreement and relying upon the representations and warranties herein set forth as and when made or deemed to be made, Lender agrees to lend to Borrower prior to the Commitment Termination Date (Loan B), one Advance in an aggregate amount not to exceed the Commitment Amount (Loan B).

(c) The Commitment Amount (Loan C). Subject to the terms and conditions of this Agreement and relying upon the representations and warranties herein set forth

as and when made or deemed to be made, Lender agrees to lend to Borrower prior to the Commitment Termination Date (Loan C), one Advance in an aggregate amount not to exceed the Commitment Amount (Loan C).

(d) The Loans and the Notes. The obligation of Borrower to repay the unpaid principal amount of and interest on the Loans shall be evidenced by one or more Notes issued to Lender.

(e) Use of Proceeds. The proceeds of the Loans shall be used solely for working capital or general corporate purposes of Borrower.

(f) Termination of Commitment to Lend. Notwithstanding anything in the Loan Documents, Lender's obligation to lend the undisbursed portion of the Commitment Amount to Borrower hereunder shall terminate on the earlier of (i) at Lender's sole election, the occurrence of any Default or Event of Default hereunder, and (ii) the applicable Commitment Termination Date. Notwithstanding the foregoing, Lender's obligation to lend the undisbursed portion of the Commitment Amount to Borrower shall terminate if, in Lender's sole judgment, there has been a material adverse change in the general affairs, management, results of operations, condition (financial or otherwise) or prospects of Borrower, whether or not arising from transactions in the ordinary course of business, or there has been any material adverse deviation by Borrower from the business plan of Borrower presented to Lender on or before the date of this Agreement.

2.2 Payments.

(a) Scheduled Payments for Advance (Loan A). Borrower shall make a payment of accrued interest only on the outstanding principal amount of the Advance (Loan A) on the first twelve (12) Payment Dates specified in the Note applicable to such Advance (Loan A) and an equal payment of principal plus accrued interest on the outstanding principal amount of the Advance (Loan A) on the next thirty (30) Payment Dates as set forth in the Note applicable to such Advance (Loan A) (collectively, the "Advance (Loan A) Scheduled Payments"). Borrower shall make such Scheduled Payments commencing on the date set forth in the Note applicable to such Advance (Loan A) and continuing thereafter on the first Business Day of each calendar month (each a "Payment Date") through the Maturity Date (Loan A). In any event, all unpaid principal and accrued interest shall be due and payable in full on the Maturity Date (Loan A).

(b) Scheduled Payments for Advance (Loan B). Borrower shall make a payment of accrued interest only on the outstanding principal amount of the Advance (Loan B) on the first twelve (12) Payment Dates specified in the Note applicable to such Advance (Loan B) and an equal payment of principal plus accrued interest on the outstanding principal amount of the Advance (Loan B) on the next thirty (30) Payment Dates as set forth in the Note applicable to such Advance (Loan B) (collectively, the "Advance (Loan B) Scheduled Payments"). Borrower shall make such Advance (Loan B) Scheduled Payments commencing on the date set forth in the Note applicable to such Advance (Loan B) and continuing thereafter on each Payment Date through the Maturity Date (Loan B). In any event, all unpaid principal and

accrued interest on Advance (Loan B) shall be due and payable in full on the Maturity Date (Loan B).

(c) Scheduled Payments for Advance (Loan C). Borrower shall make a payment of accrued interest only on the outstanding principal amount of the Advance (Loan C) on the first twelve (12) Payment Dates specified in the Note applicable to such Advance (Loan C) and an equal payment of principal plus accrued interest on the outstanding principal amount of the Advance (Loan C) on the next thirty (30) Payment Dates as set forth in the Note applicable to such Advance (Loan C) (collectively, the "Advance (Loan C) Scheduled Payments"). Borrower shall make such Advance (Loan C) Scheduled Payments commencing on the date set forth in the Note applicable to such Advance (Loan C) and continuing thereafter on each Payment Date through the Maturity Date (Loan C). In any event, all unpaid principal and accrued interest on Advance (Loan C) shall be due and payable in full on the Maturity Date (Loan C).

(d) Interim Payment. Unless the Funding Date for a Loan is the first day of a calendar month, Borrower shall pay the per diem interest (accruing at the applicable Loan Rate from the Funding Date through the last day of that month) payable with respect to such Loan on the first Business Day of the next calendar month.

(e) Payment of Interest. Borrower shall pay interest on each Loan at a fixed per annum rate of interest equal to the applicable Loan Rate. All computations of interest (including interest at the Default Rate, if applicable) shall be based on a year of twelve 30-day months. Notwithstanding any other provision hereof, the amount of interest payable hereunder shall not in any event exceed the maximum amount permitted by the law applicable to interest charged on commercial loans.

(f) Application of Payments. All payments received by Lender prior to an Event of Default shall be applied as follows: (1) first, to Lender's Expenses then due and owing; and (2) second to all Scheduled Payments then due and owing (provided, however, if such payments are not sufficient to pay the whole amount then due, such payments shall be applied first to unpaid interest at the applicable Loan Rate, then to the remaining amount then due). After an Event of Default, all payments and application of proceeds shall be made as set forth in Section 9.7.

(g) Late Payment Fee. Borrower shall pay to Lender a late payment fee equal to six percent (6%) of any Scheduled Payment not paid when due.

(h) Default Rate. Borrower shall pay interest at a per annum rate equal to the Default Rate on any amounts required to be paid by Borrower under this Agreement or the other Loan Documents (including Scheduled Payments), payable with respect to each Loan, accrued and unpaid interest, and any fees or other amounts which remain unpaid after such amounts are due. If an Event of Default has occurred and the Obligations have been accelerated (whether automatically or by Lender's election), Borrower shall pay interest on the aggregate, outstanding accelerated balance hereunder from the date of the Event of Default until all Events of Default are cured, at a per annum rate equal to the Default Rate.

2.3 Prepayments.

(a) Mandatory Prepayment Upon an Acceleration. If a Loan is accelerated following the occurrence of an Event of Default pursuant to Section 9.1(a) hereof, then Borrower, in addition to any other amounts which may be due and owing hereunder, shall immediately pay to Lender the amount set forth in Section 2.3(b) below, as if the Borrower had opted to prepay on the date of such acceleration.

(b) Upon ten (10) Business Days' prior written notice to Lender, Borrower may, at its option, at any time, prepay all of the Loans by paying to Lender an amount equal to (i) any accrued and unpaid interest on the outstanding principal balance of each Loan; (ii) an amount equal to (A) if the Loan is prepaid within twelve (12) months from the applicable Funding Date thereof, three percent (3%) of the then outstanding principal balance of such Loan, (B) if the Loan is prepaid more than twelve (12) months from the applicable Funding Date thereof but less than twenty-four (24) months from the applicable Funding Date thereof, two (2%) percent of the then outstanding principal balance of such Loan, or (C) if the Loan is prepaid more than twenty-four (24) months from the applicable Funding Date thereof, one percent (1%) of the then outstanding principal balance of such Loan; (iii) the outstanding principal balance of each Loan and (iv) all other sums, if any, that shall have become due and payable hereunder.

2.4 Other Payment Terms.

(a) Place and Manner. Borrower shall make all payments due to Lender in lawful money of the United States. All payments of principal, interest, fees and other amounts payable by Borrower hereunder shall be made, in immediately available funds, not later than 10:00 a.m. Connecticut time, on the date on which such payment is due. Borrower shall make such payments to Lender via wire transfer or ACH as follows:

Payment via wire transfer or ACH
to Lender:

Credit: Horizon Technology Finance Corporation
Bank Name:
Bank Address:
Account No.:
ABA Routing No.:
Reference: Enphase Invoice #

(b) Date. Whenever any payment is due hereunder on a day other than a Business Day, such payment shall be made on the next succeeding Business Day, and such extension of time shall be included in the computation of interest or fees, as the case may be.

2.5 Procedure for Making the Loans.

(a) Notice. Borrower shall notify Lender of the date on which Borrower desires Lender to make an Advance at least five (5) Business Days in advance of the desired Funding Date, unless Lender elects at its sole discretion to allow the Funding Date to be within five (5) Business Days of Borrower's notice. Borrower's execution and delivery to Lender of a

Note shall be Borrower's agreement to the terms and calculations thereunder with respect to the Advance made by Lender. Lender's obligation to make any Advance shall be expressly subject to the satisfaction of the conditions set forth in Section 3.

(b) Loan Rate Calculation. Prior to the Funding Date, Lender shall establish the Loan Rate with respect to the applicable Advance, which shall be set forth in the Note to be executed by Borrower with respect to such Advance and shall be conclusive in the absence of a manifest error.

(c) Disbursement. Lender shall disburse the proceeds of each Loan by wire transfer to Borrower at the account specified in the Funding Certificate for such Loan.

2.6 Good Faith Deposit; Legal and Closing Expenses; and Commitment Fee.

(a) Good Faith Deposit. Borrower has delivered to Lender a good faith deposit in the amount of Fifty Thousand Dollars (\$50,000) (the "Good Faith Deposit"). Twenty-Five Thousand Dollars (\$25,000) of the Good Faith Deposit was paid by Lender in connection with the making of Advance (Loan A), and Twenty-Five Thousand Dollars (\$25,000) of the Good Faith Deposit will be tendered by Borrower to Lender in connection with the making of Advance (Loan B). The Good Faith Deposit will be credited to the amounts due Lender under Section 2.6(b) below. If the Funding Date does not occur, Lender shall retain the Good Faith Deposit as compensation for its time, expenses and opportunity cost.

(b) Legal, Due Diligence and Documentation Expenses. Lender and Borrower acknowledge that Borrower has previously paid to Lender Twenty Thousand Dollars (\$20,000) in connection with Lender's legal, due diligence and documentation expenses incurred in connection with the making of Advance (Loan A). Concurrently with its execution and delivery of this Agreement, Borrower shall pay to Lender Lender's legal, due diligence and documentation expenses incurred in connection with the making of the Advance (Loan B) and the Advance (Loan C) in an additional amount not to exceed Twenty Thousand Dollars (\$20,000) without Borrower's prior written consent.

(c) Commitment Fee. Borrower and Lender acknowledge that Borrower has previously paid to Lender a commitment fee of Seventy Thousand Dollars (\$70,000) in connection with the making of Advance (Loan A). In addition to the previously tendered commitment fee, Borrower shall pay Lender concurrently with its execution and delivery of this Agreement an additional commitment fee in the amount of Fifty Thousand Dollars (\$50,000) (the "Commitment Fee"). The Commitment Fee shall be retained by Lender and be deemed fully earned upon receipt.

3. Conditions of Loans.

3.1 Conditions Precedent to Closing. At the time of the execution and delivery of this Agreement, Lender shall have received, in form and substance reasonably satisfactory to Lender, all of the following (unless Lender has agreed to waive such condition or document, in which case such condition or document shall be a condition precedent to the making of the applicable Advance by Lender and shall be deemed added to Section 3.2 or Section 3.3 as applicable):

(a) Loan Agreement. This Agreement duly executed by Borrower and Lender.

(b) Secretary's Certificate. A certificate of the secretary or assistant secretary of Borrower with copies of the following documents attached:

(i) the certificate of incorporation and bylaws of Borrower certified by Borrower as being complete and in full force and effect on the date thereof, (ii) incumbency and representative signatures, and (iii) resolutions authorizing the execution and delivery of this Agreement and each of the other Loan Documents.

(c) Good Standing Certificates. A good standing certificate from Borrower's state of incorporation and the state in which Borrower's principal place of business is located, each dated as of a recent date.

(d) Certificate of Insurance. Evidence of the insurance coverage required by Section 6.8 of this Agreement.

(e) Consents. All necessary consents of shareholders and other third parties with respect to the execution, delivery and performance of this Agreement, the Warrants and the other Loan Documents.

(f) Legal Opinion. A legal opinion of Borrower's counsel in form satisfactory to Lender, in substantially the form attached as Exhibit D hereto.

(g) Account Control Agreements. Account Control Agreements for all of Borrower's deposit accounts and accounts holding securities, except for the Italian Account, the French Account and the Bank of the West Account, duly executed by all of the parties thereto, in the forms provided by or reasonably acceptable to Lender.

(h) Other Documents. Such other documents and completion of such other matters, as Lender may reasonably deem necessary or appropriate.

3.2 Conditions Precedent to Making the Advance (Loan A). The obligation of Lender to make Advance (Loan A) is further subject to the following conditions:

(a) No Default. No Default or Event of Default shall have occurred and be continuing.

(b) Landlord Agreements. Borrower shall have provided Lender with a Landlord Agreement for each location where Borrower's books and records and the Collateral are located (unless Borrower is the fee owner thereof).

(c) Note. Borrower shall have duly executed and delivered to Lender a Note in the amount of Advance (Loan A).

(d) UCC Financing Statements. Lender shall have received such documents, instruments and agreements, including UCC financing statements or amendments to UCC financing statements, as Lender shall reasonably request to evidence the perfection and priority of the security interests granted to Lender pursuant to Section 4. Borrower authorizes

Lender to file any UCC financing statements, continuations of or amendments to UCC financing statements it deems necessary to perfect its security interest in the Collateral.

(e) Funding Certificate. Borrower shall have duly executed and delivered to Lender a Funding Certificate for Advance (Loan A).

(f) Intercreditor Agreement. An Intercreditor Agreement with respect to the Indebtedness constituting Permitted Indebtedness under subsection (d) of the definition of Permitted Indebtedness, executed by the lender providing such Indebtedness.

(g) Warrant. Borrower shall have executed and delivered to Lender the Loan A Warrant.

(h) Other Documents. Such other documents and completion of such other matters, as Lender may reasonably deem necessary or appropriate.

3.3 Condition to the Advance (Loan B). In addition to the conditions set forth in Sections 3.1 and 3.2 above, Borrower agrees that it shall not request, and Lender shall have no obligation to make, Advance (Loan B) until:

(a) Loan A. Lender has made Advance (Loan A).

(b) Loan B Warrant. Borrower shall have executed and delivered to Lender the Loan B Warrant.

(c) Other Documents. Borrower shall have executed and delivered to Lender such other documents, and completed such other matters, as Lender may reasonably deem necessary or appropriate.

3.4 Condition to the Advance (Loan C). In addition to the conditions set forth in Sections 3.1, 3.2 and 3.3 above, Borrower agrees that it shall not request, and Lender shall have no obligation to make, Advance (Loan C) until:

(a) Loan A. Lender has made Advance (Loan A).

(b) Loan B. Lender has made Advance (Loan B).

(c) Other Documents. Borrower shall have executed and delivered to Lender such other documents, and completed such other matters, as Lender may reasonably deem necessary or appropriate.

3.5 Covenant to Deliver. Borrower agrees (not as a condition but as a covenant) to deliver to Lender each item required to be delivered to Lender as a condition to each Advance, if such Advance is advanced. Borrower expressly agrees that the extension of such Advance prior to the receipt by Lender of any such item shall not constitute a waiver by Lender of Borrower's obligation to deliver such item, and any such extension in the absence of a required item shall be in Lender's sole discretion.

4. Creation of Security Interest.

4.1 Grant of Security Interest. Borrower grants to Lender a valid and continuing security interest in all presently existing and hereafter acquired or arising Collateral in order to secure prompt, full and complete payment of any and all Obligations (other than the Warrant and inchoate indemnity obligations) and in order to secure prompt, full and complete performance by Borrower of each of its covenants and duties under each of the Loan Documents (other than the Warrant). The “Collateral” shall mean and include all right, title, interest, claims and demands of Borrower in and to all personal property of Borrower, including without limitation, all of the following:

(a) All goods (and embedded computer programs and supporting information included within the definition of “goods” under the Code) and equipment now owned or hereafter acquired, including, without limitation, all laboratory equipment, computer equipment, office equipment, machinery, fixtures, vehicles (including motor vehicles and trailers), and any interest in any of the foregoing, and all attachments, accessories, accessions, replacements, substitutions, additions, and improvements to any of the foregoing, wherever located;

(b) All inventory now owned or hereafter acquired, including, without limitation, all merchandise, raw materials, parts, supplies, packing and shipping materials, work in process and finished products including such inventory as is temporarily out of Borrower’s custody or possession or in transit and including any returns upon any accounts or other proceeds, including insurance proceeds, resulting from the sale or disposition of any of the foregoing and any documents of title representing any of the above, and Borrower’s books relating to any of the foregoing;

(c) All contract rights and general intangibles (except to the extent included within the definition of Intellectual Property), now owned or hereafter acquired, including, without limitation, goodwill, license agreements, franchise agreements, blueprints, drawings, purchase orders, customer lists, route lists, infringements, claims, software, computer programs, computer disks, computer tapes, literature, reports, catalogs, design rights, income tax refunds, payment intangibles, commercial tort claims, payments of insurance and rights to payment of any kind;

(d) All now existing and hereafter arising accounts, contract rights, royalties, license rights, license fees and all other forms of obligations owing to Borrower arising out of the sale or lease of goods, the licensing of technology or the rendering of services by Borrower (subject, in each case, to the contractual rights of third parties to require funds received by Borrower to be expended in a particular manner), whether or not earned by performance, and any and all credit insurance, guaranties, and other security therefor, as well as all merchandise returned to or reclaimed by Borrower and Borrower’s books relating to any of the foregoing;

(e) All documents, cash, deposit accounts, letters of credit (whether or not the letter of credit is evidenced by a writing), certificates of deposit, instruments, promissory notes, chattel paper (whether tangible or electronic) and investment property, including, without limitation, all securities, whether certificated or uncertificated, security entitlements, securities

accounts, commodity contracts and commodity accounts, and all financial assets held in any securities account or otherwise, wherever located, now owned or hereafter acquired and Borrower's books relating to the foregoing;

(f) Any and all claims, rights and interests in any of the above and all substitutions for, additions and accessions to and proceeds thereof, including, without limitation, insurance, condemnation, requisition or similar payments and proceeds of the sale or licensing of Intellectual Property to the extent such proceeds no longer constitute Intellectual Property; and

(g) Notwithstanding the foregoing, the Collateral shall not include any Intellectual Property; provided, however, that the Collateral shall include all accounts receivables, accounts, and general intangibles that consist of rights to payment and proceeds from the sale, licensing or disposition of all or any part, or rights in, the foregoing (the "Rights to Payment"). Notwithstanding the foregoing, if a judicial authority (including a U.S. Bankruptcy Court) holds that a security interest in the underlying Intellectual Property is necessary to have a security interest in the Rights to Payment, then the Collateral shall automatically, and effective as of the date hereof, include the Intellectual Property to the extent necessary to permit perfection of Lender's security interest in the Rights to Payment.

Notwithstanding the foregoing, the term "Collateral" shall not include (A) equipment identified on Annex I hereto, or (B) or rights of Borrower as a licensee; in each case of (A) and (B) to the extent the granting of a security interest therein (i) would be contrary to applicable law or (ii) is prohibited by or would constitute a default under any agreement or document governing such property (but only to the extent such prohibition is enforceable under applicable law); provided that upon the termination or lapsing of any such prohibition, such property shall automatically be part of the Collateral; and provided further that the provisions of this paragraph shall in no case exclude from the definition of "Collateral" any Accounts, proceeds of the disposition of any property, or general intangibles consisting of rights to payment, all of which shall at all times constitute "Collateral"; and provided further that any Equipment financed by Lender will at all times constitute "Collateral".

4.2 After-Acquired Property. If Borrower shall at any time acquire a commercial tort claim, as defined in the Code, Borrower shall immediately notify Lender in writing signed by Borrower of the brief details thereof and grant to Lender in such writing a security interest therein and in the proceeds thereof, all upon the terms of this Agreement, with such writing to be in form and substance satisfactory to Lender.

4.3 Duration of Security Interest. Lender's security interest in the Collateral shall continue until the payment in full and the satisfaction of all Obligations (other than inchoate indemnity obligations) and termination of Lender's commitment to fund the Loans, whereupon such security interest shall terminate. Lender shall, at Borrower's sole cost and expense, execute such further documents and take such further actions as may be reasonably necessary to make effective the release contemplated by this Section 4.3, including duly authorizing and delivering termination statements for filing in all relevant jurisdictions under the Code.

4.4 Location and Possession of Collateral. Other than for Borrower's personal property located at Flextronics and for Transfers permitted under Section 7.4, the Collateral is and shall remain in the possession of Borrower at its location listed on the cover page hereof or as set forth in the Disclosure Schedule. Borrower shall remain in full possession, enjoyment and control of the Collateral (except only as may be otherwise required by Lender for perfection of its security interest therein) and so long as no Event of Default has occurred, shall be entitled to manage, operate and use the same and each part thereof with the rights and franchises appertaining thereto; provided that the possession, enjoyment, control and use of the Collateral shall at all time be subject to the observance and performance of the terms of this Agreement.

4.5 Delivery of Additional Documentation Required. Borrower shall from time to time execute and deliver to Lender, at the request of Lender, all financing statements and other documents Lender may reasonably request, in form satisfactory to Lender, to perfect and continue Lender's perfected security interests in the Collateral and in order to consummate fully all of the transactions contemplated under the Loan Documents.

4.6 Right to Inspect. Lender (through any of its officers, employees, or agents) shall have the right, upon reasonable prior notice, from time to time during Borrower's usual business hours, to inspect Borrower's books and records and to make copies thereof and to inspect, test, and appraise the Collateral in order to verify Borrower's financial condition or the amount, condition of, or any other matter relating to, the Collateral.

4.7 Protection of Intellectual Property. Borrower shall (i) protect, defend and maintain the validity and enforceability of its Intellectual Property to the extent Borrower deems it appropriate to do so in its reasonable business judgment and promptly advises Lender in writing of material infringements, and (ii) not allow any Intellectual Property material to Borrower's business to be abandoned, forfeited or dedicated to the public without Lender's written consent.

4.8 Lien Subordination. Lender agrees that the Liens granted to it hereunder shall be subordinate to the Liens to secure the Indebtedness permitted under clause (d) of the definition of Permitted Indebtedness. So long as no Event of Default has occurred, Lender agrees to execute and deliver such agreements and documents as may be reasonably requested by Borrower from time to time which set forth the lien subordination described in this Section 4.8 and are reasonably acceptable to Lender.

5. Representations and Warranties. Except as set forth in the Disclosure Schedule, Borrower represents and warrants as follows:

5.1 Organization and Qualification. Borrower is a corporation duly organized and validly existing under the laws of its state of incorporation and qualified and licensed to do business in, and is in good standing in, any state in which the conduct of its business or its ownership of Property requires that it be so qualified or in which the Collateral is located, except for such states as to which any failure to so qualify would not have a material adverse effect on Borrower.

5.2 Authority. Borrower has all necessary power and authority to execute, deliver, and perform in accordance with the terms thereof, the Loan Documents to which it is a party. Borrower has all requisite power and authority to own and operate its Property and to carry on its businesses as now conducted. Borrower has obtained all licenses, permits, approvals and other authorizations necessary for the operation of its business.

5.3 Conflict with Other Instruments, etc. Neither the execution and delivery of any Loan Document to which Borrower is a party nor the consummation of the transactions therein contemplated nor compliance with the terms, conditions and provisions thereof will conflict with or result in a breach of any of the terms, conditions or provisions of the certificate of incorporation, the by-laws, or any other organizational documents of Borrower or any law or any regulation, order, writ, injunction or decree of any court or governmental instrumentality or any material agreement or instrument to which Borrower is a party or by which it or any of its Property is bound or to which it or any of its Property is subject, or constitute a default thereunder or result in the creation or imposition of any Lien, other than Permitted Liens.

5.4 Authorization; Enforceability. The execution and delivery of this Agreement, the granting of the security interest in the Collateral, the incurring of the Loans, the execution and delivery of the other Loan Documents to which Borrower is a party and the consummation of the transactions herein and therein contemplated have each been duly authorized by all necessary action on the part of Borrower. No authorization, consent, approval, license or exemption of, and no registration, qualification, designation, declaration or filing with, or notice to, any Person is, was or will be necessary to (i) the valid execution and delivery of any Loan Document to which Borrower is a party, (ii) the performance of Borrower's obligations under any Loan Document, or (iii) the granting of the security interest in the Collateral, except for filings in connection with the perfection of the security interest in any of the Collateral or the issuance of the Warrant. The Loan Documents have been duly executed and delivered and constitute legal, valid and binding obligations of Borrower, enforceable in accordance with their respective terms, except as the enforceability thereof may be limited by bankruptcy, insolvency or other similar laws of general application relating to or affecting the enforcement of creditors' rights or by general principles of equity.

5.5 No Prior Encumbrances. Borrower has good and marketable title to the Collateral, free and clear of Liens except for Permitted Liens. Borrower has good title and ownership of, or is licensed under, all of Borrower's current Intellectual Property. Borrower has not received any communications alleging that Borrower has violated, or by conducting its business as proposed, would violate any proprietary rights of any other Person. Borrower has no knowledge of any infringement or violation by it of the intellectual property rights of any third party and has no knowledge of any violation or infringement by a third party of any of its Intellectual Property. The Collateral and the Intellectual Property constitute substantially all of the assets and property of Borrower.

5.6 Name; Location of Chief Executive Office, Principal Place of Business and Collateral. Except as set forth on the Disclosure Schedule, Borrower has not done business under any name other than that specified on the signature page hereof. Borrower's jurisdiction of incorporation, chief executive office, principal place of business, and the place where Borrower maintains its records concerning the Collateral are presently located in the state and at

the address set forth on the cover page of this Agreement. The Collateral is presently located at the address set forth on the cover page hereof or as set forth in the Disclosure Schedule.

5.7 Litigation. There are no actions or proceedings pending by or against Borrower before any court or administrative agency in which an adverse decision could have a material adverse effect on Borrower or the aggregate value of the Collateral. Borrower does not have knowledge of any such pending or threatened actions or proceedings.

5.8 Financial Statements. All financial statements relating to Borrower or any Affiliate that have been or may hereafter be delivered by Borrower to Lender present fairly in all material respects Borrower's financial condition as of the date thereof and Borrower's results of operations for the period then ended.

5.9 No Material Adverse Effect. No event has occurred and no condition exists which could reasonably be expected to have a material adverse effect on the financial condition, business or operations of Borrower since December 31, 2009.

5.10 Full Disclosure. No representation, warranty or other statement made by Borrower in any Loan Document (including the Disclosure Schedule), certificate or written statement furnished to Lender contains any untrue statement of a material fact or omits to state a material fact necessary in order to make the statements contained in such certificates or statements not misleading. There is no fact known to Borrower which materially adversely affects, or which could in the future be reasonably expected to materially adversely affect, its ability to perform its obligations under this Agreement.

5.11 Solvency, Etc. Borrower is Solvent (as defined below) and, after the execution and delivery of the Loan Documents and the consummation of the transactions contemplated thereby, Borrower will be Solvent. "Solvent" means, with respect to any Person on any date, that on such date such Person is able to pay its debts (including trade debts) as they mature.

5.12 Subsidiaries. Borrower has no Subsidiaries as of the date hereof and shall have no subsidiaries after the date hereof, except subsidiaries for which Borrower obtained Lender's prior written consent (which consent shall not be unreasonably withheld, conditioned or delayed).

5.13 Catastrophic Events: Labor Disputes. Neither Borrower nor its properties is or has been affected by any fire, explosion, accident, strike, lockout or other labor dispute, drought, storm, hail, earthquake, embargo, act of God or other casualty that could reasonably be expected to have a material adverse effect on the financial condition, business or operations of Borrower. There are no disputes presently subject to grievance procedure, arbitration or litigation under any of the collective bargaining agreements, employment contracts or employee welfare or incentive plans to which Borrower is a party, and there are no strikes, lockouts, work stoppages or slowdowns, or, to the knowledge of Borrower, jurisdictional disputes or organizing activity occurring or threatened which could reasonably be expected to have a material adverse effect on the financial condition, business or operations of Borrower.

5.14 Certain Agreements of Officers, Employees and Consultants.

(a) No Violation. To the knowledge of Borrower, no officer, employee or consultant of Borrower is, or is now expected to be, in violation of any term of any employment contract, proprietary information agreement, nondisclosure agreement, noncompetition agreement or any other material contract or agreement or any restrictive covenant relating to the right of any such officer, employee or consultant to be employed by Borrower because of the nature of the business conducted or to be conducted by Borrower or relating to the use of trade secrets or proprietary information of others, and to Borrower's knowledge, the continued employment of Borrower's officers, employees and consultants does not subject Borrower to any material liability for any claim or claims arising out of or in connection with any such contract, agreement, or covenant.

(b) No Present Intention to Terminate. To the knowledge of Borrower, no officer of Borrower, and no employee or consultant of Borrower whose termination, either individually or in the aggregate, could reasonably be expected to have a material adverse effect on the financial condition, business or operations of Borrower, has any present intention of terminating his or her employment or consulting relationship with Borrower.

6. Affirmative Covenants. Borrower, until the full and complete payment of the Obligations (other than inchoate indemnity obligations), covenants and agrees that:

6.1 Good Standing. Borrower shall maintain its corporate existence and its good standing in its jurisdiction of incorporation and maintain qualification in each jurisdiction in which the failure to so qualify could reasonably be expected to have a material adverse effect on the financial condition, operations or business of Borrower. Borrower shall maintain in force all licenses, approvals and agreements, the loss of which could reasonably be expected to have a material adverse effect on its financial condition, operations or business.

6.2 Government Compliance. Borrower shall comply with all statutes, laws, ordinances and government rules and regulations to which it is subject, noncompliance with which could reasonably be expected to materially adversely affect the financial condition, operations or business of Borrower.

6.3 Financial Statements, Reports, Certificates. Borrower shall deliver to Lender: (a) as soon as available, but in any event within thirty (30) days after the end of each month, a company prepared balance sheet, income statement and cash flow statement covering Borrower's operations during such period, certified by Borrower's president, controller or chief financial officer (each, a "Responsible Officer"); (b) as soon as available, but in any event within one hundred eighty (180) days after the end of Borrower's fiscal year commencing with Borrowers' fiscal year 2010, audited financial statements of Borrower prepared in accordance with GAAP, together with an unqualified opinion (other than a qualification for a going concern) on such financial statements of a nationally recognized or other independent public accounting firm reasonably acceptable to Lender; (c) as soon as available, but in any event within ninety (90) days after the end of Borrower's fiscal year or the date of Borrower's board of directors' adoption, Borrower's operating budget and plan for the next fiscal year and (d) such other financial information as Lender may reasonably request from time to time. From and

after such time as Borrower becomes a publicly reporting company, promptly as they are available and in any event: (x) at the time of filing of Borrower's Form 10-K with the Securities and Exchange Commission after the end of each fiscal year of Borrower, the financial statements of Borrower filed with such Form 10-K; and (y) at the time of filing of Borrower's Form 10-Q with the Securities and Exchange Commission after the end of each of the first three fiscal quarters of Borrower, the financial statements of Borrower filed with such Form 10-Q. In addition, Borrower shall deliver to Lender (i) promptly upon becoming available, copies of all statements, reports and notices sent or made available generally by Borrower to its security holders; and (ii) immediately upon receipt of notice thereof, a report of any material legal actions pending or threatened against Borrower or the commencement of any action, proceeding or governmental investigation involving Borrower is commenced that is reasonably expected to result in damages or costs to Borrower of Two Hundred Fifty Thousand Dollars (\$250,000).

6.4 Certificates of Compliance. Each time financial statements are furnished pursuant to Section 6.3 above, Borrower shall deliver to Lender an Officer's Certificate signed by a Responsible Officer in the form of, and certifying to the matters set forth in Exhibit E hereto.

6.5 Notice of Defaults. As soon as possible, and in any event within five (5) days after the discovery of an Event of Default, Borrower shall provide Lender with an Officer's Certificate setting forth the facts relating to or giving rise to such Event of Default and the action which Borrower proposes to take with respect thereto.

6.6 Taxes. Borrower shall make due and timely payment or deposit of all federal, state, and local taxes, assessments, or contributions required of it by law or imposed upon any Property belonging to it, and will execute and deliver to Lender, on demand, appropriate certificates attesting to the payment or deposit thereof; and Borrower will make timely payment or deposit of all tax payments and withholding taxes required of it by applicable laws, including those laws concerning F.I.C.A., F.U.T.A., state disability, and local, state, and federal income taxes, and will, upon request, furnish Lender with proof satisfactory to Lender indicating that Borrower has made such payments or deposits; provided that Borrower need not make any payment if the amount or validity of such payment is contested in good faith by appropriate proceedings which suspend the collection thereof (provided that such proceedings do not involve any substantial danger of the sale, forfeiture or loss of any material item of Collateral or Collateral which in the aggregate is material to Borrower and that Borrower has adequately bonded such amounts or reserves sufficient to discharge such amounts have been provided on the books of Borrower).

6.7 Use; Maintenance. Borrower shall keep and maintain all items of equipment and other similar types of personal property that form any significant portion or portions of the Collateral in good operating condition and repair and shall make all necessary replacements thereof and renewals thereto so that the value and operating efficiency thereof shall at all times be maintained and preserved. Borrower shall not permit any such material item of Collateral to become a fixture to real estate or an accession to other personal property, without the prior written consent of Lender. Borrower shall not permit any such material item of Collateral to be operated or maintained in violation of any applicable law, statute, rule or regulation. With respect to items of leased equipment (to the extent Lender has any security interest in any

residual Borrower's interest in such equipment under the lease), Borrower shall keep, maintain, repair, replace and operate such leased equipment in accordance with the terms of the applicable lease.

6.8 Insurance. Borrower shall keep its business and the Collateral insured for risks and in amounts, as Lender may reasonably request. Insurance policies shall be in a form, with companies, and in amounts that are satisfactory to Lender. All property policies shall have a lender's loss payable endorsement showing Lender as an additional loss payee and all liability policies shall show Lender as an additional insured. Borrower shall provide Lender at least twenty (20) days notice before cancellation of its insurance policies. At Lender's request, Borrower shall deliver certified copies of policies and evidence of all premium payments. Proceeds payable under any property policy shall, at Lender's option, be payable to Lender on account of the Obligations. Notwithstanding the foregoing, so long as no Event of Default has occurred and is continuing, Borrower shall have the option of applying the proceeds of any property policy, toward the replacement or repair of destroyed or damaged property; provided that (i) any such replaced or repaired property (a) shall be of equal or like value as the replaced or repaired Collateral and (b) shall be deemed Collateral in which Lender has been granted a first priority security interest and (ii) after the occurrence and during the continuation of an Event of Default all proceeds payable under such property policy shall, at the option of Lender, be payable to Lender, on account of the Obligations. If Borrower fails to obtain insurance as required under Section 6.8 or to pay any amount or furnish any required proof of payment to third persons and Lender, Lender may make all or part of such payment or obtain such insurance policies required in Section 6.8, and take any action under the policies Lender deems prudent. On or prior to the first Funding Date and prior to each policy renewal, Borrower shall furnish to Lender certificates of insurance or other evidence satisfactory to Lender that insurance complying with all of the above requirements is in effect.

6.9 Security Interest. Assuming the proper filing of one or more financing statement(s) identifying the Collateral with the proper state and/or local authorities, the security interests in the Collateral granted to Lender pursuant to this Agreement (i) constitute and will continue to constitute first priority security interests (except to the extent any Permitted Liens may have a superior priority to Lender's Lien under this Agreement) and (ii) are and will continue to be superior and prior to the rights of all other creditors of Borrower (except to the extent of such Permitted Liens).

6.10 Further Assurances. At any time and from time to time Borrower shall execute and deliver such further instruments and take such further action as may reasonably be requested by Lender to make effective the purposes of this Agreement, including without limitation, the continued perfection and priority of Lender's security interest in the Collateral.

6.11 Subsidiaries. Borrower, upon Lender's reasonable request, shall cause any Subsidiary of Borrower to provide Lender with a guaranty of the Obligations and a security interest in such Subsidiary's assets to secure such guaranty.

7. Negative Covenants. Borrower, until the full and complete payment of the Obligations (other than inchoate indemnity obligations), covenants and agrees that Borrower shall not without Lender's prior written consent, which shall not be unreasonably withheld:

7.1 Chief Executive Office. Change its name, jurisdiction of incorporation, chief executive office, principal place of business or any of the items set forth in Section 1 of the Disclosure Schedule without thirty (30) days prior written notice to Lender. Lender acknowledges receipt of notice that as of the date of this Agreement Borrower intends to relocate its principal place of business on or about August 15, 2011 to 18 South McDowell, Petaluma, California.

7.2 Collateral Control. Subject to its rights under Section 4.4 and other than for Transfers permitted under Section 7.4, remove any items of Collateral from Borrower's facility located at the address set forth on the cover page hereof or as set forth on the Disclosure Schedule.

7.3 Liens. Create, incur, assume or suffer to exist any Lien of any kind upon any of Borrower's Property, whether now owned or hereafter acquired, except Permitted Liens.

7.4 Other Dispositions of Collateral. Convey, sell, lease or otherwise dispose of all or any part of the Collateral to any Person (collectively, a "Transfer"), except for: (i) Transfers of inventory in the ordinary course of business; (ii) Transfers of worn-out or obsolete equipment; (iii) Transfers permitted under subclause (f) of the definition of Permitted Liens with respect to Collateral, (iv) Transfers in connection with Permitted Liens and Permitted Investments; or (v) Transfers that are not otherwise permitted under this Section 7.4 in an amount not to exceed Two Hundred Fifty Thousand Dollars (\$100,000) in the aggregate in any fiscal year.

7.5 Distributions. (i) Pay any dividends or make any distributions on its Equity Securities; (ii) purchase, redeem, retire, defease or otherwise acquire for value any of its Equity Securities (other than repurchases pursuant to the terms of employee stock purchase plans, employee restricted stock agreements or similar arrangements in an aggregate amount not to exceed Two Hundred Fifty Thousand Dollars (\$250,000)); (iii) return any capital to any holder of its Equity Securities as such; (iv) make any distribution of assets, Equity Securities, obligations or securities to any holder of its Equity Securities as such; or (v) set apart any sum for any such purpose; provided, however. Borrower may pay dividends payable solely in Borrower's common stock.

7.6 Mergers or Acquisitions. Merge or consolidate with or into any other Person (other than mergers or consolidations of a Subsidiary into another Subsidiary or into Borrower) or acquire all or substantially all of the capital stock or assets of another.

7.7 Change in Ownership. Engage in or permit any of its Subsidiaries to engage in any business other than the businesses currently engaged in by Borrower or reasonably related thereto or have a material change in its ownership of greater than forty nine percent (49%) (other than by the sale by Borrower of Borrower's Equity Securities in a public offering or to venture capital investors so long as Borrower identifies to Lender the venture capital investors prior to the closing of the investment).

7.8 Transactions With Affiliates/Subsidiaries. (a) Enter into any contractual obligation with any Affiliate or engage in any other transaction with any Affiliate except (i)

upon terms at least as favorable to Borrower as an arms-length transaction with Persons who are not Affiliates of Borrower or are otherwise approved by the disinterested members of Borrower's board of directors, and (ii) Borrower's sale of equity and debt securities (provided that such debt securities are Subordinated Debt) to venture capital or other strategic investors or (b) create a Subsidiary, unless, at Lender's election, such Subsidiary guarantees the Obligations and grants a security interest in its assets to secure such guaranty, provided that Lender further agrees not to unreasonably withhold, condition or delay its consent to the creation of a Subsidiary.

7.9 Indebtedness Payments. (i) Prepay, redeem, purchase, defease or otherwise satisfy in any manner prior to the scheduled repayment thereof any Indebtedness for borrowed money or lease obligations (other than (i) Indebtedness or lease obligations in an aggregate amount not to exceed \$250,000 per fiscal year, (ii) amounts due or permitted to be prepaid under this Agreement, or (iii) Permitted Indebtedness including without limitation under any revolving credit agreement constituting Permitted Indebtedness under clause (d) of the definition of Permitted Indebtedness and Indebtedness owing to Atel Ventures, Inc. (collectively, the "Excluded Indebtedness")), (ii) amend, modify or otherwise change the terms of any Indebtedness for borrowed money or lease obligations (other than Excluded Indebtedness) so as to accelerate the scheduled repayment thereof or (iii) repay any notes to officers, directors or shareholders other than converting any such notes into equity securities of the company.

7.10 Indebtedness. Create, incur, assume or permit to exist any Indebtedness except Permitted Indebtedness.

7.11 Investments. Make any Investment except for Permitted Investments.

7.12 Compliance. Become an "investment company" or a company controlled by an "investment company" under the Investment Company Act of 1940 or undertake as one of its important activities extending credit to purchase or carry margin stock, or use the proceeds of any Loan for that purpose; fail to meet the minimum funding requirements of the Employment Retirement Income Security Act of 1974, and its regulations, as amended from time to time ("ERISA"), permit a Reportable Event or Prohibited Transaction, as defined in ERISA, to occur; fail to comply with the Federal Fair Labor Standards Act or violate any other law or regulation, if the violation could reasonably be expected to have a material adverse effect on Borrower's business or operations or could reasonably be expected to cause a material adverse change, or permit any of its Subsidiaries to do so.

7.13 Maintenance of Accounts. (i) Maintain any deposit account or account holding securities owned by Borrower except (a) accounts with the lender providing Borrower with Indebtedness permitted under subsection (d) of the definition of Permitted Indebtedness or (b) accounts with respect to which Lender is able to take such actions as it deems necessary to obtain a perfected security interest in such accounts through one or more Account Control Agreements; or (ii) grant or allow any other Person (other than Lender) to perfect a security interest in, or enter into any agreements with any Persons (other than Lender) accomplishing perfection via control as to any of its deposit accounts or accounts holding securities other than in favor of the lender providing Borrower with Indebtedness permitted under subsection (d) of

the definition of Permitted Indebtedness. Notwithstanding the foregoing, Borrower may maintain: (1) a deposit account at _____, account number (the "Italian Account"), (2) a deposit account with having account number (the "French Account" and collectively with the Italian Account, the "Foreign Accounts") and (3) a deposit account with _____, having an account number of (the "Account"), provided that (x) less than One Million Euros (€ 1,000,000) in the aggregate is maintained by the Borrower in the Foreign Accounts and (y) less than Five Thousand Dollars (\$5,000) is maintained by the Borrower in the _____ Account.

7.14 Negative Pledge Regarding Intellectual Property. Create, incur, assume or suffer to exist any Lien of any kind upon any Intellectual Property or Transfer any Intellectual Property (other than for Transfers permitted under subclause (f) of the definition of Permitted Liens), whether now owned or hereafter acquired.

7.15 Inventory and Equipment. Store Inventory or Equipment with an aggregate value in excess of Fifty Thousand Dollars (\$50,000) with a bailee, warehouseman, or other third party other than Flextronics (international or domestic locations) unless the third party has been notified of Lender's security interest and Lender (a) has received an acknowledgment from the third party that it is holding or will hold the Inventory or Equipment for Lender's benefit or (b) is in pledge possession of the warehouse receipt, where negotiable, covering such Inventory or Equipment. Store or maintain any Equipment or Inventory with an aggregate value in excess of Fifty Thousand Dollars (\$50,000) at a location other than at Flextronics (international or domestic locations) or the location set forth in Section 10 of this Agreement. Notwithstanding the foregoing, Borrower may maintain up to One Million Dollars (\$1,000,000) in raw materials in transit (from Borrower's supplier(s) to Flextronics' manufacturing facility in China), without complying with (a) or (b), above.

8. Events of Default. Any one or more of the following events shall constitute an "Event of Default" by Borrower under this Agreement:

8.1 Failure to Pay. If Borrower fails to pay when due and payable or when declared due and payable in accordance with the Loan Documents: (i) any Scheduled Payment on the relevant Payment Date or on the relevant Maturity Date, or (ii) any other portion of the Obligations within five (5) days after receipt of written notice from Lender that such payment is due.

8.2 Certain Covenant Defaults. If Borrower fails to perform any obligation under violates any of the covenants contained in Section 7 of this Agreement.

8.3 Other Covenant Defaults. If Borrower fails or neglects to perform, keep, or observe any other material term, provision, condition, covenant, or agreement contained in this Agreement (other than as set forth in Sections 8.1, 8.2 or 8.4 through 8.13), in any of the other Loan Documents and Borrower has failed to cure such default within fifteen (15) days of the occurrence of such default. During this fifteen (15) day period, the failure to cure the default is not an Event of Default (but no Loan will be made during the cure period).

8.4 Intentionally Omitted.

8.5 Seizure of Assets, Etc. If any material portion of Borrower's assets is attached, seized, subjected to a writ or distress warrant, or is levied upon, or comes into the possession of any trustee, receiver or Person acting in a similar capacity and such attachment, seizure, writ or distress warrant or levy has not been removed, discharged or rescinded within ten (10) days, or if Borrower is enjoined, restrained, or in any way prevented by court order from continuing to conduct all or any material part of its business affairs, or if a judgment or other claim becomes a lien or encumbrance upon any material portion of Borrower's assets, or if a notice of lien, levy, or assessment is filed of record with respect to any of Borrower's assets by the United States Government, or any department, agency, or instrumentality thereof, or by any state, county, municipal, or governmental agency, and the same is not paid within ten (10) days after Borrower receives notice thereof; provided that none of the foregoing shall constitute an Event of Default where such action or event is stayed or an adequate bond has been posted pending a good faith contest by Borrower.

8.6 Service of Process. The service of process upon Lender seeking to attach by a trustee or other process any funds of the Borrower on deposit or otherwise held by Lender, or the delivery upon Lender of a notice of foreclosure by any Person seeking to attach or foreclose on any funds of the Borrower on deposit or otherwise held by Lender, or the delivery of a notice of foreclosure or exclusive control to any entity holding or maintaining Borrower's deposit accounts or accounts holding securities by any Person (other than Lender) seeking to foreclose or attach any such accounts or securities.

8.7 Default on Indebtedness. One or more defaults shall exist under any agreement with any third party or parties which consists of the failure to pay any Indebtedness at maturity or which results in a right by such third party or parties, whether or not exercised, to accelerate the maturity of Indebtedness in an aggregate amount in excess of Two Hundred Fifty Thousand Dollars (\$250,000) provided, however, that the Event of Default under this Section 8.7 caused by the occurrence of a default under such other agreement shall be cured or waived for purposes of this Agreement upon Lender receiving written notice from the party asserting such default of such cure or waiver of the default under such other agreement, if at the time of such cure or waiver under such other agreement (x) Lender has not declared an Event of Default under this Agreement and/or exercised any rights with respect thereto; (y) any such cure or waiver does not result in an Event of Default under any other provision of this Agreement or any Loan Document; and (z) in connection with any such cure or waiver under such other agreement, the terms of any agreement with such third party are not modified or amended in any manner which could in the good faith judgment of Lender be materially less advantageous to Borrower or any Subsidiary

8.8 Judgments. If a judgment or judgments for the payment of money in an amount, individually or in the aggregate, of at least Two Hundred Fifty Thousand Dollars (\$250,000) shall be rendered against Borrower and shall remain unsatisfied and unstayed for a period of ten (10) days or more.

8.9 Misrepresentations. If any material misrepresentation or material misstatement exists now or hereafter in any warranty, representation, statement, certification, or report made to Lender by Borrower or any officer, employee, agent, or director of Borrower.

8.10 Intentionally Omitted.

8.11 Unenforceable Loan Document. If any Loan Document shall in any material respect cease to be, or Borrower shall assert that any Loan Document is not, a legal, valid and binding obligation of Borrower enforceable in accordance with its terms.

8.12 Involuntary Insolvency Proceeding. If a proceeding shall have been instituted in a court having jurisdiction in the premises seeking a decree or order for relief in respect of Borrower in an involuntary case under any applicable bankruptcy, insolvency or other similar law now or hereafter in effect, or for the appointment of a receiver, liquidator, assignee, custodian, trustee (or similar official) of Borrower or for any substantial part of its Property, or for the winding-up or liquidation of its affairs, and such proceeding shall remain undismissed or unstayed and in effect for a period of forty five (45) consecutive days or such court shall enter a decree or order granting the relief sought in such proceeding.

8.13 Voluntary Insolvency Proceeding. If Borrower shall commence a voluntary case under any applicable bankruptcy, insolvency or other similar law now or hereafter in effect, shall consent to the entry of an order for relief in an involuntary case under any such law, or shall consent to the appointment of or taking possession by a receiver, liquidator, assignee, trustee, custodian (or other similar official) of Borrower or for any substantial part of its Property, or shall make a general assignment for the benefit of creditors, or shall fail generally to pay its debts as they become due, or shall take any corporate action in furtherance of any of the foregoing.

9. Lender's Rights and Remedies.

9.1 Rights and Remedies. Upon the occurrence of any Default or Event of Default, Lender shall not have any further obligation to advance money or extend credit to or for the benefit of Borrower. In addition, upon the occurrence of an Event of Default, Lender shall have the rights, options, duties and remedies of a secured party as permitted by law and, in addition to and without limitation of the foregoing, Lender may, at its election, without notice of election and without demand, do any one or more of the following, all of which are authorized by Borrower:

(a) Acceleration of Obligations. Declare all Obligations, whether evidenced by this Agreement, by any of the other Loan Documents, or otherwise, including (i) any accrued and unpaid interest, (ii) the amounts which would have otherwise come due under Section 2.3(b)(ii) if the Loans had been voluntarily prepaid, (iii) the unpaid principal balance of the Loans and (iv) all other sums, if any, that shall have become due and payable hereunder, immediately due and payable (provided that upon the occurrence of an Event of Default described in Section 8.12 or 8.13 all Obligations shall become immediately due and payable without any action by Lender);

(b) Protection of Collateral. Make such payments and do such acts as Lender considers necessary or reasonable to protect Lender's security interest in the Collateral. Borrower agrees to assemble the Collateral if Lender so requires and to make the Collateral available to Lender as Lender may designate. Borrower authorizes Lender and its designees and agents to enter the premises where the Collateral is located, to take and maintain possession of the Collateral, or any part of it, and to pay, purchase, contest, or compromise any Lien which in Lender's determination appears or is claimed to be prior or superior to its security interest and to pay all expenses incurred in connection therewith. With respect to any of Borrower's owned premises, Borrower hereby grants Lender a license to enter into possession of such premises and to occupy the same, without charge, for up to one hundred twenty (120) days in order to exercise any of Lender's rights or remedies provided herein, at law, in equity, or otherwise;

(c) Preparation of Collateral for Sale. Ship, reclaim, recover, store, finish, maintain, repair, prepare for sale, advertise for sale, and sell (in the manner provided for herein) the Collateral. Lender and its agents and any purchasers at or after foreclosure are hereby granted a non-exclusive, irrevocable, perpetual, fully paid, royalty-free license or other right, solely pursuant to the provisions of this Section 9.1, to use, without charge, Borrower's Intellectual Property, including without limitation, labels, patents, copyrights, rights of use of any name, trade secrets, trade names, trademarks, service marks, and advertising matter, or any Property of a similar nature, now or at any time hereafter owned or acquired by Borrower or in which Borrower now or at any time hereafter has any rights; provided that such license shall only be exercisable in connection with the disposition of Collateral upon Lender's exercise of its remedies hereunder;

(d) Sale of Collateral. Sell the Collateral at either a public or private sale, or both, by way of one or more contracts or transactions, for cash or on terms, in such manner and at such places (including Borrower's premises) as Lender determines are commercially reasonable; and

(e) Purchase of Collateral. Credit bid and purchase all or any portion of the Collateral at any public sale.

Any deficiency that exists after disposition of the Collateral as provided above will be paid immediately by Borrower.

9.2 Set Off Right. Lender may set off and apply to the Obligations any and all indebtedness at any time owing to or for the credit or the account of Borrower or any other assets of Borrower in Lender's possession or control.

9.3 Effect of Sale. Upon the occurrence of an Event of Default, to the extent permitted by law, Borrower covenants that it will not at any time insist upon or plead, or in any manner whatsoever claim or take any benefit or advantage of, any stay or extension law now or at any time hereafter in force, nor claim, take nor insist upon any benefit or advantage of or from any law now or hereafter in force providing for the valuation or appraisal of the Collateral or any part thereof prior to any sale or sales thereof to be made pursuant to any provision herein contained, or to the decree, judgment or order of any court of competent jurisdiction; nor, after such sale or sales, claim or exercise any right under any statute now or

hereafter made or enacted by any state or otherwise to redeem the property so sold or any part thereof, and, to the full extent legally permitted, except as to rights expressly provided herein, hereby expressly waives for itself and on behalf of each and every Person, except decree or judgment creditors of Borrower, acquiring any interest in or title to the Collateral or any part thereof subsequent to the date of this Agreement, all benefit and advantage of any such law or laws, and covenants that it will not invoke or utilize any such law or laws or otherwise hinder, delay or impede the execution of any power herein granted and delegated to Lender, but will suffer and permit the execution of every such power as though no such power, law or laws had been made or enacted. Any sale, whether under any power of sale hereby given or by virtue of judicial proceedings, shall operate to divest all right, title, interest, claim and demand whatsoever, either at law or in equity, of Borrower in and to the Property sold, and shall be a perpetual bar, both at law and in equity, against Borrower, its successors and assigns, and against any and all Persons claiming the Property sold or any part thereof under, by or through Borrower, its successors or assigns.

9.4 Power of Attorney in Respect of the Collateral. Borrower does hereby irrevocably appoint Lender (which appointment is coupled with an interest), the true and lawful attorney in fact of Borrower with full power of substitution, for it and in its name to file any notices of security interests, financing statements and continuations and amendments thereof pursuant to the Code or federal law, as may be necessary to perfect, or to continue the perfection of Lender's security interests in the Collateral. Borrower does hereby irrevocably appoint Lender (which appointment is coupled with an interest) on the occurrence of an Event of Default, the true and lawful attorney in fact of Borrower with full power of substitution, for it and in its name: (a) to ask, demand, collect, receive, receipt for, sue for, compound and give acquittance for any and all rents, issues, profits, avails, distributions, income, payment draws and other sums in which a security interest is granted under Section 4 with full power to settle, adjust or compromise any claim thereunder as fully as if Lender were Borrower itself; (b) to receive payment of and to endorse the name of Borrower to any items of Collateral (including checks, drafts and other orders for the payment of money) that come into Lender's possession or under Lender's control; (c) to make all demands, consents and waivers, or take any other action with respect to, the Collateral; (d) in Lender's discretion to file any claim or take any other action or proceedings, either in its own name or in the name of Borrower or otherwise, which Lender may reasonably deem necessary or appropriate to protect and preserve the right, title and interest of Lender in and to the Collateral; (e) endorse Borrower's name on any checks or other forms of payment or security; (f) sign Borrower's name on any invoice or bill of lading for any account or drafts against account debtors; (g) make, settle, and adjust all claims under Borrower's insurance policies; (h) settle and adjust disputes and claims about the accounts directly with account debtors, for amounts and on terms Lender determines reasonable; (i) transfer the Collateral into the name of Lender or a third party as the Code permits; and (j) to otherwise act with respect thereto as though Lender were the outright owner of the Collateral.

9.5 Lender's Expenses. If Borrower fails to pay any amounts or furnish any required proof of payment due to third persons or entities, as required under the terms of this Agreement, then Lender may do any or all of the following: (a) make payment of the same or any part thereof; or (b) obtain and maintain insurance policies of the type discussed in Section 6.8 of this Agreement, and take any action with respect to such policies as Lender deems prudent. Any amounts paid or deposited by Lender shall constitute Lender's Expenses,

shall be immediately due and payable, shall bear interest at the Default Rate and shall be secured by the Collateral. Any payments made by Lender shall not constitute an agreement by Lender to make similar payments in the future or a waiver by Lender of any Event of Default under this Agreement. Borrower shall pay all reasonable fees and expenses, including without limitation, Lender's Expenses, incurred by Lender in the enforcement or attempt to enforce any of the Obligations hereunder not performed when due.

9.6 Remedies Cumulative. Lender's rights and remedies under this Agreement, the Loan Documents, and all other agreements shall be cumulative. Lender shall have all other rights and remedies not inconsistent herewith as provided under the Code, by law, or in equity. No exercise by Lender of one right or remedy shall be deemed an election, and no waiver by Lender of any Event of Default on Borrower's part shall be deemed a continuing waiver. No delay by Lender shall constitute a waiver, election, or acquiescence by it.

9.7 Application of Collateral Proceeds. The proceeds and/or avails of the Collateral, or any part thereof, and the proceeds and the avails of any remedy hereunder (as well as any other amounts of any kind held by Lender, at the time of or received by Lender after the occurrence of an Event of Default hereunder) shall be paid to and applied as follows:

(a) First, to the payment of out-of-pocket costs and expenses, including all amounts expended to preserve the value of the Collateral, of foreclosure or suit, if any, and of such sale and the exercise of any other rights or remedies, and of all proper fees, expenses, liability and advances, including reasonable legal expenses and attorneys' fees, incurred or made hereunder by Lender, including, without limitation, Lender's Expenses;

(b) Second, to the payment to Lender of the amount then owing or unpaid on the Loans for any accrued and unpaid interest, the amounts which would have otherwise come due under Section 2.3(b)(ii), if the Loans had been voluntarily prepaid, the principal balance of the Loans, and all other Obligations with respect to the Loans (provided, however, if such proceeds shall be insufficient to pay in full the whole amount so due, owing or unpaid upon the Loans, then to the unpaid interest thereon, then to the amounts which would have otherwise come due under Section 2.3(b)(ii), if the Loans had been voluntarily prepaid, then to the principal balance of the Loans, and then to the payment of other amounts then payable to Lender under any of the Loan Documents); and

(c) Third, to the payment of the surplus, if any, to Borrower, its successors and assigns, or to the Person lawfully entitled to receive the same.

9.8 Reinstatement of Rights. If Lender shall have proceeded to enforce any right under this Agreement or any other Loan Document by foreclosure, sale, entry or otherwise, and such proceedings shall have been discontinued or abandoned for any reason or shall have been determined adversely, then and in every such case (unless otherwise ordered by a court of competent jurisdiction), Lender shall be restored to its former position and rights hereunder with respect to the Property subject to the security interest created under this Agreement.

10. Waivers; Indemnification.

10.1 Demand; Protest. Borrower waives demand, protest, notice of protest, notice of default or dishonor, notice of payment and nonpayment, notice of any default, nonpayment at maturity, release, compromise, settlement, extension, or renewal of accounts, documents, instruments, chattel paper, and guarantees at any time held by Lender on which Borrower may in any way be liable.

10.2 Lender's Liability for Collateral. So long as Lender complies with its obligations, if any, under the Code, Lender shall not in any way or manner be liable or responsible for: (a) the safekeeping of the Collateral; (b) any loss or damage thereto occurring or arising in any manner or fashion from any cause other than Lender's gross negligence or willful misconduct; (c) any diminution in the value thereof; or (d) any act or default of any carrier, warehouseman, bailee, forwarding agency, or other Person whomsoever. All risk of loss, damage or destruction of the Collateral shall be borne by Borrower.

10.3 Indemnification and Waiver. Whether or not the transactions contemplated hereby shall be consummated:

(a) General Indemnity. Borrower agrees upon demand to pay or reimburse Lender for all liabilities, obligations and out-of-pocket expenses, including Lender's Expenses and reasonable fees and expenses of counsel for Lender from time to time arising in connection with the enforcement or collection of sums due under the Loan Documents, and in connection with any amendment or modification of the Loan Documents or any "work-out" in connection with the Loan Documents. Borrower shall indemnify, reimburse and hold Lender, and each of its respective successors, assigns, agents, attorneys, officers, directors, equity holders, servants, agents and employees (each an "Indemnified Person") harmless from and against all liabilities, losses, damages, actions, suits, demands, claims of any kind and nature (including claims relating to environmental discharge, cleanup or compliance), all costs and expenses whatsoever to the extent they may be incurred or suffered by such Indemnified Person in connection therewith (including reasonable attorneys' fees and expenses), fines, penalties (and other charges of any applicable Governmental Authority), licensing fees relating to any item of Collateral, damage to or loss of use of property (including consequential or special damages to third parties or damages to Borrower's property), or bodily injury to or death of any person (including any agent or employee of Borrower) (each, a "Claim"), directly or indirectly relating to or arising out of the use of the proceeds of the Loans or otherwise, the falsity of any representation or warranty of Borrower or Borrower's failure to comply with the terms of this Agreement or any other Loan Document. The foregoing indemnity shall cover, without limitation, (i) any Claim in connection with a design or other defect (latent or patent) in any item of equipment or product included in the Collateral, (ii) any Claim for infringement of any patent, copyright, trademark or other intellectual property right, (iii) any Claim resulting from the presence on or under or the escape, seepage, leakage, spillage, discharge, emission or release of any Hazardous Materials on the premises owned, occupied or leased by Borrower, including any Claims asserted or arising under any Environmental Law, (iv) any Claim for negligence or strict or absolute liability in tort, or (v) any Claim asserted as to or arising under any Account Control Agreement or any Landlord Agreement; provided, however, Borrower shall not indemnify Lender for any liability incurred by Lender as a direct and sole result of Lender's gross negligence or willful misconduct. Such

indemnities shall continue in full force and effect, notwithstanding the expiration or termination of this Agreement. Upon Lender's written demand, Borrower shall assume and diligently conduct, at its sole cost and expense, the entire defense of Lender, each of its members, partners, and each of their respective, agents, employees, directors, officers, equity holders, successors and assigns against any indemnified Claim described in this Section 10.3(a). Borrower shall not settle or compromise any Claim against or involving Lender without first obtaining Lender's written consent thereto, which consent shall not be unreasonably withheld.

(b) Waiver. NOTWITHSTANDING ANYTHING TO THE CONTRARY CONTAINED IN THIS AGREEMENT OR ANYWHERE ELSE, BORROWER AGREES THAT IT SHALL NOT SEEK FROM LENDER UNDER ANY THEORY OF LIABILITY (INCLUDING ANY THEORY IN TORTS), ANY SPECIAL, INDIRECT, CONSEQUENTIAL OR PUNITIVE DAMAGES.

(c) Survival; Defense. The obligations in this Section 10.3 shall survive payment of all other Obligations pursuant to Section 12.8. At the election of any Indemnified Person, Borrower shall defend such Indemnified Person using legal counsel satisfactory to such Indemnified Person in such Person's reasonable discretion, at the sole cost and expense of Borrower. All amounts owing under this Section 10.3 shall be paid within thirty (30) days after written demand.

11. Notices. Unless otherwise provided in this Agreement, all notices or demands by any party relating to this Agreement or any other agreement entered into in connection herewith shall be in writing and (except for financial statements and other informational documents which may be sent by first-class mail, postage prepaid) shall be personally delivered or sent by certified mail, postage prepaid, return receipt requested, by prepaid nationally recognized overnight courier, or by prepaid facsimile to Borrower or to Lender, as the case may be, at their respective addresses set forth below:

If to Borrower:	Enphase Energy, Inc. 201 1 st Street, Suite 300 Petaluma, CA 94952 Attention: Chief Financial Officer
If to Lender:	Horizon Technology Finance Corporation 76 Batterson Park Road Farmington, CT 06032 Attention: Legal Department

The parties hereto may change the address at which they are to receive notices hereunder, by notice in writing in the foregoing manner given to the other.

12. General Provisions.

12.1 Successors and Assigns. This Agreement and the Loan Documents shall bind and inure to the benefit of the respective successors and permitted assigns of each of the parties; provided, however, neither this Agreement nor any rights hereunder may be assigned by Borrower without Lender's prior written consent, which consent may be granted or withheld in Lender's sole discretion. Lender shall have the right without the consent of or notice to Borrower to sell, transfer, assign, negotiate, or grant participations in all or any part of, or any interest in Lender's rights and benefits hereunder. Lender may disclose the Loan Documents and any other financial or other information relating to Borrower or any Subsidiary to any potential participant or assignee of any of the Loans, provided that such participant or assignee agrees to protect the confidentiality of such documents and information using the same measures that it uses to protect its own confidential information. Borrower hereby authorizes and directs Lender, for and on behalf of the Borrower, to maintain a record of ownership of the Notes and any interest therein, which record, or "book-entry system", shall identify the owner or owners of the Notes and any interests therein. Notwithstanding any other provision of this Agreement or the Loan Documents, the right to the principal of, and stated interest on, the Notes may be transferred only through such book-entry system.

12.2 Time of Essence. Time is of the essence for the performance of all obligations set forth in this Agreement.

12.3 Severability of Provisions. Each provision of this Agreement shall be severable from every other provision of this Agreement for the purpose of determining the legal enforceability of any specific provision.

12.4 Entire Agreement; Construction; Amendments and Waivers.

(a) Entire Agreement. This Agreement and each of the other Loan Documents dated as of the date hereof, taken together, constitute and contain the entire agreement between Borrower and Lender and supersede any and all prior agreements, negotiations, correspondence, understandings and communications between the parties, whether written or oral, respecting the subject matter hereof. Borrower acknowledges that it is not relying on any representation or agreement made by Lender or any employee, attorney or agent thereof, other than the specific agreements set forth in this Agreement and the Loan Documents.

(b) Construction. This Agreement is the result of negotiations between and has been reviewed by each of Borrower and Lender as of the date hereof and their respective counsel; accordingly, this Agreement shall be deemed to be the product of the parties hereto, and no ambiguity shall be construed in favor of or against Borrower or Lender. Borrower and Lender agree that they intend the literal words of this Agreement and the other Loan Documents and that no parol evidence shall be necessary or appropriate to establish Borrower's or Lender's actual intentions.

(c) Amendments and Waivers. Any and all discharges or waivers of, or consents to any departures from any provision of this Agreement or of any of the other Loan Documents shall not be effective without the written consent of Lender. Any and all amendments

and modifications of this Agreement or of any of the other Loan Documents shall not be effective without the written consent of Lender and Borrower. Any waiver or consent with respect to any provision of the Loan Documents shall be effective only in the specific instance and for the specific purpose for which it was given. No notice to or demand on Borrower in any case shall entitle Borrower to any other or further notice or demand in similar or other circumstances. Any amendment, modification, waiver or consent affected in accordance with this Section 12.4 shall be binding upon Lender and on Borrower.

12.5 Reliance by Lender. All covenants, agreements, representations and warranties made herein by Borrower shall be deemed to be material to and to have been relied upon by Lender, notwithstanding any investigation by Lender.

12.6 No Set-Offs by Borrower. All sums payable by Borrower pursuant to this Agreement or any of the other Loan Documents shall be payable without notice or demand and shall be payable in United States Dollars without set-off or reduction of any manner whatsoever.

12.7 Counterparts. This Agreement may be executed in any number of counterparts and by different parties on separate counterparts (including signatures delivered by facsimile or other electronic means), each of which, when executed and delivered, shall be deemed to be an original, and all of which, when taken together, shall constitute but one and the same Agreement.

12.8 Survival. All covenants, representations and warranties made in this Agreement shall continue in full force and effect so long as any Obligations or commitment to fund remain outstanding. The obligations of Borrower to indemnify Lender with respect to the expenses, damages, losses, costs and liabilities described in Section 10.3 shall survive until all applicable statute of limitations periods with respect to actions that may be brought against Lender have run.

13. Relationship of Parties. Borrower and Lender acknowledge, understand and agree that the relationship between Borrower, on the one hand, and Lender, on the other, is, and at all time shall remain solely that of a borrower and lender. Lender shall not under any circumstances be construed to be a partner or a joint venturer of Borrower or any of its Affiliates; nor shall Lender under any circumstances be deemed to be in a relationship of confidence or trust or a fiduciary relationship with Borrower or any of its Affiliates, or to owe any fiduciary duty to Borrower or any of its Affiliates. Lender does not undertake or assume any responsibility or duty to Borrower or any of its Affiliates to select, review, inspect, supervise, pass judgment upon or otherwise inform Borrower or any of its Affiliates of any matter in connection with its or their Property, any Collateral held by Lender or the operations of Borrower or any of its Affiliates. Borrower and each of its Affiliates shall rely entirely on their own judgment with respect to such matters, and any review, inspection, supervision, exercise of judgment or supply of information undertaken or assumed by Lender in connection with such matters is solely for the protection of Lender and neither Borrower nor any Affiliate is entitled to rely thereon.

14. Confidentiality. In handling any information that Borrower notifies Lender is to be considered confidential, Lender agrees to use the same degree of care to safeguard and prevent

disclosure of such confidential information as Lender uses with its own confidential information, but in any event no less than a reasonable degree of care. Lender shall not disclose such information to any third party (other than to Lender's members, partners, attorneys, governmental regulators, or auditors, or to Lender's subsidiaries and affiliates and prospective transferees and purchasers of the Loan, all subject to the same confidentiality obligation set forth herein or as required by law, regulation, subpoena or other order to be disclosed) and shall use such information only for purposes of evaluation of its investment in Borrower and the exercise of Lender's rights and the enforcement of its remedies under this Agreement and the other Loan Documents. The obligations of confidentiality shall not apply to any information that (a) was known to the public prior to disclosure by Borrower under this Agreement, (b) becomes known to the public through no fault of Lender, (c) is disclosed to Lender by a third party having a legal right to make such disclosure, or (d) is independently developed by Lender. Notwithstanding the foregoing, Lender's agreement of confidentiality shall not apply if Lender has acquired indefeasible title to any Collateral or in connection with any enforcement or exercise of Lender's rights and remedies under this Agreement following an Event of Default, including the enforcement of Lender's security interest in the Collateral.

15. CHOICE OF LAW AND VENUE; JURY TRIAL WAIVER. THIS AGREEMENT SHALL BE GOVERNED BY, AND CONSTRUED AND ENFORCED IN ACCORDANCE WITH, THE INTERNAL LAWS OF THE STATE OF CONNECTICUT, WITHOUT REGARD TO PRINCIPLES OF CONFLICTS OF LAWS. EACH OF BORROWER AND LENDER HEREBY SUBMITS TO THE NON-EXCLUSIVE JURISDICTION OF THE STATE AND FEDERAL COURTS LOCATED IN THE STATE OF CONNECTICUT. BORROWER AND LENDER HEREBY WAIVE THEIR RESPECTIVE RIGHTS TO A JURY TRIAL OF ANY CLAIM OR CAUSE OF ACTION BASED UPON OR ARISING OUT OF ANY OF THE LOAN DOCUMENTS OR ANY OF THE TRANSACTIONS CONTEMPLATED THEREIN, INCLUDING CONTRACT CLAIMS, TORT CLAIMS, BREACH OF DUTY CLAIMS, AND ALL OTHER COMMON LAW OR STATUTORY CLAIMS.

[Remainder of page intentionally left blank.]

IN WITNESS WHEREOF, the parties hereto have caused this Agreement to be executed as of the date first above written.

BORROWER:
ENPHASE ENERGY, INC.

By: /s/ Paul Nahi
Name: Paul Nahi
Title: President and Chief Executive Officer

LENDER:
HORIZON TECHNOLOGY FINANCE CORPORATION

By: /s/ Robert D. Pomeroy, Jr.
Robert D. Pomeroy, Jr.
Chief Executive Officer

ASSIGNEE AND HOLDER OF ADVANCE (LOAN A):
HORIZON CREDIT I LLC

By: Compass Horizon Funding Company LLC, its sole member
By: Horizon Technology Finance Corporation, its sole member

By: /s/ Robert D. Pomeroy, Jr.
Name: Robert D. Pomeroy, Jr.
Title: Chief Executive Officer

LIST OF EXHIBITS AND SCHEDULES

Exhibit A	Intentionally Omitted
Exhibit B	Funding Certificate
Exhibit C	Form of Note
Exhibit D	Form of Legal Opinion
Exhibit E	Form of Officer's Certificate

EXHIBIT A

Intentionally Omitted

EXHIBIT B

FUNDING CERTIFICATE

The undersigned, being the duly elected and acting _____ of ENPHASE ENERGY, INC., a Delaware corporation (“Borrower”), does hereby certify to HORIZON TECHNOLOGY FINANCE CORPORATION, (the “Lender”) in connection with that certain Venture Loan and Security Agreement dated on or about the date hereof by and between Borrower and Lender (the “Loan Agreement”; with other capitalized terms used below having the meanings ascribed thereto in the Loan Agreement) that:

1. The representations and warranties made by Borrower in Section 5 of the Loan Agreement and in the other Loan Documents are true and correct as of the date hereof.
2. No event or condition has occurred that would constitute a Default or an Event of Default under the Loan Agreement or any other Loan Document.
3. Borrower is in compliance with the covenants and requirements contained in Sections 4, 6 and 7 of the Loan Agreement.
4. All conditions referred to in Section 3 of the Loan Agreement to the making of the Loan to be made on or about the date hereof have been satisfied.
5. No material adverse change in the general affairs, management, results of operations, condition (financial or otherwise) or prospects of Borrower, whether or not arising from transactions in the ordinary course of business, has occurred.
6. The proceeds for the Advance shall be disbursed as follows:

Disbursement from Lender:	
Loan Amount	\$2,000,000
Less:	
Legal Fees	\$
Balance of Commitment Fee	\$
Net Proceeds due from Lender:	\$

7. The aggregate net proceeds of the Advance in the amount of \$_____ shall be transferred to Borrower's account as follows:

Account Name:
Bank Name:
Bank Address:
Account Number:
ABA Number:

Dated: _____, 2011

BORROWER:
ENPHASE ENERGY, INC.

By: _____

Name: _____

Title: _____

EXHIBIT C

SECURED PROMISSORY NOTE

\$2,000,000.00

Dated: March __, 2011

FOR VALUE RECEIVED, the undersigned, ENPHASE ENERGY, INC., a Delaware corporation ("Borrower"), HEREBY PROMISES TO PAY to HORIZON TECHNOLOGY FINANCE CORPORATION, a Delaware corporation ("Lender") the principal amount of Two Million Dollars (\$2,000,000.00) or such lesser amount as shall equal the outstanding principal balance of the applicable Advance (the "Loan") made to Borrower by Lender pursuant to the Loan Agreement (as defined below), and to pay all other amounts due with respect to the Loan on the dates and in the amounts set forth in the Loan Agreement.

Interest on the principal amount of this Note from the date of this Note shall accrue at a fixed rate equal to the Loan Rate as set forth herein, or, if applicable, the Default Rate. The Loan Rate for this Note is __% per annum based on a year of twelve 30-day months. If the Funding Date is not the first day of the month, interim interest accruing from Funding Date through the last day of that month shall be paid on the first calendar day of the next calendar month, Commencing _____, 200__, through and including _____, 200__, on the first day of each month (each an "Interest Payment Date") Borrower shall make payments of accrued interest only on the outstanding principal amount of the Loan in the amount of _____ Dollars (\$_____), Commencing on _____, 200__, and continuing on the first day of each month thereafter (each a "Principal and Interest Payment Date" and, collectively with each Interest Payment Date, each a "Payment Date"), Borrower shall make to Lender ____ (__) equal payments of principal plus accrued interest on the then outstanding principal amount due under each in the amount of _____ Dollars (\$_____). If not sooner paid, all outstanding amounts hereunder and under the Loan Agreement shall become due and payable on _____.

Principal, interest and all other amount due with respect to the Loan, are payable in lawful money of the United States of America to Lenders as set forth in the Loan Agreement. The principal amount of this Note and the interest rate applicable thereto, and all payments made with respect thereto, shall be recorded by Lender and, prior to any transfer hereof, endorsed on the grid attached hereto which is part of this Note.

This Note is referred to in, and is entitled to the benefits of, the Amended and Restated Venture Loan and Security Agreement on or about the date hereof by and between Borrower and Lender (the "Loan Agreement"). The Loan Agreement, among other things, (a) provides for the making of secured Loans to Borrower, and (b) contains provisions for acceleration of the maturity hereof upon the happening of certain stated events.

This Note may not be prepaid, except as set forth in Section 2.3 of the Loan Agreement.

This Note and the obligation of Borrower to repay the unpaid principal amount of the Loan, interest on the Loan and all other amounts due Lender under the Loan Agreement is secured under the Loan Agreement.

Presentment for payment, demand, notice of protest and all other demands and notices of any kind in connection with the execution, delivery, performance and enforcement of this Note are hereby waived.

Borrower shall pay all reasonable fees and expenses, including, without limitation, reasonable attorneys' fees and costs, incurred by Lender in the enforcement or limitation, to enforce any of Borrower's obligations hereunder not performed when due. This Note shall be governed by, and construed and interpreted in accordance with, the laws of the State of Connecticut.

IN WITNESS WHEREOF, Borrower has caused this Note to be duly executed by one of its officers thereunto duly authorized on the date hereof.

BORROWER:
ENPHASE ENERGY, INC.

By: _____

Name: _____

Title: _____

EXHIBIT D

TO BE MUTUALLY AGREED UPON BY LENDER'S AND BORROWER'S COUNSEL

EXHIBIT E

FORM OF OFFICER'S CERTIFICATE

TO: COMPASS HORIZON FUNDING COMPANY LLC

Reference is made to the Amended and Restated Venture Loan and Security Agreement dated as of March __, 2011 (as it may be amended from time to time, the "Loan Agreement") and between ENPHASE ENERGY, INC. ("Borrower") and COMPASS HORIZON FUNDING COMPANY LLC ("Lender"). Unless otherwise defined herein, capitalized terms have the meanings given such terms in the Loan Agreement.

The undersigned Responsible Officer of Borrower hereby certifies to Lender that:

1. No Event of Default has occurred under the Loan Agreement. (If an Event of Default has occurred, specify the nature and extent thereof and the action Borrower proposes to take with respect thereto.)
2. The information provided in Section 1 of the Disclosure Schedule is currently true and accurate, except as noted below.
3. Borrower is in compliance with the provision with provisions of Sections 4.6 and 7 of the Loan Agreement, except as noted below.
4. Attached herewith are the [monthly financial statements pursuant to Section 6.3(a) of the Loan Agreement/annual audited financial statement pursuant to Section 6.3(b) of the Loan Agreement]. These have been prepared in accordance with GAAP and are consistent from one period to the next except as noted below.

NOTES TO ABOVE CERTIFICATIONS:

BORROWER:
ENPHASE ENERGY, INC.

By: _____
Name: _____
Title: _____

**FIRST AMENDMENT OF AMENDED AND RESTATED VENTURE LOAN AND
SECURITY AGREEMENT**

This FIRST AMENDMENT OF AMENDED AND RESTATED VENTURE LOAN AND SECURITY AGREEMENT (this "Agreement"), dated as of June 30, 2011, is entered into by and between ENPHASE ENERGY, INC., a Delaware corporation ("Borrower"), and HORIZON TECHNOLOGY FINANCE CORPORATION ("Lender"), a Delaware corporation.

RECITALS

A. Borrower and Lender are parties to a certain Amended and Restated Venture Loan and Security Agreement dated as of March 25, 2011 (the "Loan Agreement") pursuant to which Lender, among other things, has (i) provided certain loan to Borrower as evidenced by (a) certain Secured Promissory Notes executed by Borrower in favor of Lender, in original principal amounts of Nine Million Dollars (\$9,000,000.00) (the "Notes"), and (ii) been granted a security interest in all assets of Borrower, except for Borrower's Intellectual Property (as defined in the Loan Agreement).

B. Borrower has now requested that Lender permit Borrower to create a certain Subsidiary (as defined in the Loan Agreement) in New Zealand, and open and maintain a certain deposit account in New Zealand in connection with the creation of such Subsidiary.

C. Lender is willing to grant such request, but only to the extent, and in accordance with the terms, and subject to the conditions, set forth herein.

AGREEMENT

NOW, THEREFORE, in consideration of the above recitals and for other good and valuable consideration, the receipt and adequacy of which are hereby acknowledged, Borrower and Lender hereby agree as follows:

1. Definitions; Interpretation. Unless otherwise defined herein, all capitalized terms used herein and defined in the Loan Agreement shall have the respective meanings given to those terms in the Loan Agreement. Other rules of construction set forth in the Loan Agreement, to the extent not inconsistent with this Agreement, apply to this Agreement and are hereby incorporated by reference.

2. Confirmation. Borrower hereby acknowledges and agrees that: (i) the Loan Agreement sets forth the legal, valid, binding and continuing Obligations of Borrower to Lender, (ii) the Obligations to Lender under the Loan Agreement are secured by validly perfected security interests in all assets of Borrower, except for Borrower's Intellectual Property, and with respect to Third Party Equipment, consistent with the provisions of Section 4.8 of the Loan Agreement, and (iii) Borrower has no cause of action, claim, defense or set-off against the Lender in any way regarding or relating to the Loan Agreement or Lender's actions thereunder and to the extent any such cause of action, claim, defense or set-off ever existed, it is waived and Lender is released from any claims of Borrower. Borrower represents and warrants that no Default or Event of Default has occurred under the Loan Agreement.

3. Amendments to Loan Agreement.

(a) Borrower and Lender agree that the reference to “July 31, 2011” after the phrase “Commitment Termination Date (Loan C) appearing on the cover page of the Loan Agreement is deleted in its entirety and is replaced by “September 30, 2011.”

(b) Borrower and Lender hereby agree that the definition of “Subsidiary” within Section 1.1 of the Loan Agreement is hereby deleted in its entirety and replaced with the following:

““Subsidiary” means any corporation or other entity of which a majority of the outstanding Equity Securities entitled to vote for the election of directors or other governing body (otherwise than as the result of a default) is owned by Borrower directly or indirectly through Subsidiaries, including without limitation Enphase Energy SAS, Enphase Energy SRL and Enphase Energy New Zealand Limited.”

(c) Borrower and Lender hereby agree that Section 7.13 of the Loan Agreement is hereby deleted in its entirety and replaced with the following:

“7.13 Maintenance of Accounts. (i) Maintain any deposit account or account holding securities owned by Borrower except (a) accounts with the lender providing Borrower with Indebtedness permitted under subsection (d) of the definition of Permitted Indebtedness or (b) accounts with respect to which Lender is able to take such actions as it deems necessary to obtain a perfected security interest in such accounts through one or more Account Control Agreements; or (ii) grant or allow any other Person (other than Lender) to perfect a security interest in, or enter into any agreements with any Persons (other than Lender) accomplishing perfection via control as to any of its deposit accounts or accounts holding securities other than in favor of the lender providing Borrower with Indebtedness permitted under subsection (d) of the definition of Permitted Indebtedness. Notwithstanding the foregoing, Borrower may maintain: (1) a deposit account at Banca Popolare di Milano, BPM, subsidiary, having account number (the “Italian Account”), (2) a deposit account with BNP Paribas having account number (the “French Account”), (3) a deposit account with Bank of New Zealand having an account number (the “New Zealand Account” and collectively with the Italian Account and the French Account, the “Foreign Accounts”), and (4) a deposit account with Bank of the West, having an account number of (the “Bank of the West Account”), provided that (x) less than One Million euro (€1,000,000) in the aggregate is maintained by the Borrower in the Foreign Accounts and (y) less than Five Thousand Dollars (\$5,000) is maintained by the Borrower in the Bank of the West Account.”

4. Conditions to Effectiveness. Lender’s consent and agreement herein is expressly conditioned on all of the following:

(a) Borrower executing and delivering an executed copy of this Agreement;

- (b) Borrower executing and delivering an executed copy of the letter agreement of even date herewith between Borrower and Lender pursuant to which Lender waived notice of, and consented to, the creation of the Subsidiaries (as defined therein) and the opening and maintenance of the Foreign Accounts; and
- (c) Borrower's payment of Lender's in-house legal expenses in the amount of Five Thousand and 00/100 Dollars (\$5,000.00) incurred in connection with the drafting, negotiation and execution of this Agreement.

5. Effect of Agreement. On and after the date hereof, each reference to the Loan Agreement in the Loan Agreement or in any other document shall mean the Loan Agreement as amended by this Agreement. Except as expressly provided hereunder, the execution, delivery and effectiveness of this Agreement shall not operate as a waiver of any right, power, or remedy of Lender, nor constitute a waiver of any provision of the Loan Agreement Except to the limited extent expressly provided herein, nothing contained herein shall, or shall be construed to (nor shall the Borrower ever argue to the contrary) (i) modify the Loan Agreement or any other Loan Document (ii) modify, waive, impair, or affect any of the covenants, agreements, terms, and conditions thereof, or (iii) waive the due keeping, observance and/or performance thereof, each of which is hereby ratified and confirmed by the Borrower. Except as amended above, the Loan Agreement remains in full force and effect.

6. Headings. Headings in this Agreement are for convenience of reference only and are not part of the substance hereof.

7. Governing Law. This Agreement shall be governed by and construed in accordance with the laws of the State of Connecticut without reference to conflicts of law rules.

8. Counterparts. This Agreement may be executed in any number of counterparts, including by electronic or facsimile transmission, each of which when so delivered shall be deemed an original, but all such counterparts taken together shall constitute but one and the same instrument.

9. Integration. This Agreement and the Loan Documents constitute and contain the entire agreement of Borrower and Lender with respect to their respective subject matters, and supercede any and all prior agreements, correspondence and communications.

[Remainder of page intentionally left blank]

IN WITNESS WHEREOF, Borrower and Lender have caused this Agreement to be executed as of the day and year first above written.

BORROWER:
ENPHASE ENERGY, INC.

By: /s/ Sanjeev Kumar
Name: Sanjeev Kumar _____
Title: CFO _____

LENDER:
HORIZON TECHNOLOGY FINANCE
CORPORATION

By: /s/ Robert D. Pomeroy, Jr.
Name: Robert D. Pomeroy, Jr. _____
Title: Chief Executive Officer

ENPHASE ENERGY, INC.

**BRIDGE BANK, NATIONAL ASSOCIATION
COMERICA BANK**

AMENDED AND RESTATED LOAN AND SECURITY AGREEMENT

This **AMENDED AND RESTATED LOAN AND SECURITY AGREEMENT** is entered into as of March 24, 2011, by and between **BRIDGE BANK, NATIONAL ASSOCIATION** (“Bridge” and, solely in its capacity as collateral agent for the Lenders (as defined below), “Collateral Agent”), **COMERICA BANK** (“Comerica” and, collectively, with Bridge, the “Lenders” and each, individually, a “Lender”) and **INPHASE ENERGY, INC.** (“Borrower”).

RECITALS

Borrower and Bridge are parties to that certain Loan and Security Agreement, dated as of January 19, 2010 (as amended from time to time, including that certain Loan and Security Modification Agreement dated as of April 20, 2010, that certain Loan and Security Modification Agreement dated as of June 7, 2010 and that certain Loan and Security Modification Agreement dated as of September 13, 2010, collectively, the “Original Agreement”). Borrower and Lenders wish to amend and restate the terms of the Original Agreement. This Agreement sets forth the terms on which Lenders will advance credit to Borrower, and Borrower will repay the amounts owing to Lenders.

AGREEMENT

The parties agree as follows:

1. DEFINITIONS AND CONSTRUCTION.

1.1 Definitions. As used in this Agreement, the following terms shall have the following definitions:

“Accounts” means all presently existing and hereafter arising accounts, contract rights, payment intangibles, and all other forms of obligations owing to Borrower arising out of the sale or lease of goods (including, without limitation, the licensing of software and other technology) or the rendering of services by Borrower, whether or not earned by performance, and any and all credit insurance, guaranties, and other security therefor, as well as all merchandise returned to or reclaimed by Borrower and Borrower’s Books relating to any of the foregoing.

“Advance” or “Advances” means a cash advance or cash advances under the Revolving Facility.

“Affiliate” means, with respect to any Person, any Person that owns or controls directly or indirectly such Person, any Person that controls or is controlled by or is under common control with such Person, and each of such Person’s senior executive officers, directors, and partners.

“Approved Forecast” has the meaning assigned in Section 6.7.

“Atel” means ATEL Ventures, Inc.

“Atel Indebtedness” means indebtedness of Borrower in favor of Atel, not to exceed the principal amount of Two Hundred Sixteen Thousand Nine Hundred Seventy Four Dollars (\$216,974) as of January 31, 2011.

“Borrower’s Books” means all of Borrower’s books and records including: ledgers; records concerning Borrower’s assets or liabilities the Collateral, business operations or financial condition; and all computer programs, or tape files, and the equipment, containing such information.

“Borrowing Base” means an amount equal to (1) eighty percent (80%) of Eligible Accounts, plus (2) fifty percent (50%) of Eligible Inventory (provided that Advances against Eligible Inventory shall not exceed the lesser of fifty percent (50%) of Eligible Accounts or Ten Million Dollars (\$10,000,000)); all as determined by Lenders with reference to the most recent Borrowing Base Certificate delivered by Borrower.

“Business Day” means any day that is not a Saturday, Sunday, or other day on which banks in the State of California are authorized or required to close.

“Change in Control” shall mean a transaction in which any “person” or “group” (within the meaning of Section 13(d) and 14(d)(2) of the Securities Exchange Act of 1934) becomes the “beneficial owner” (as defined in Rule 13d-3 under the Securities Exchange Act of 1934), directly or indirectly, of a sufficient number of shares of all classes of stock then outstanding of Borrower ordinarily entitled to vote in the election of directors, empowering such “person” or “group” to elect a majority of the Board of Directors of Borrower, who did not have such power-before such transaction.

“Closing Date” means the date of this Agreement.

“Code” means the California Uniform Commercial Code.

“Collateral” means the property described on **Exhibit A** attached hereto.

“Collateral Agent” means, Bridge, not in its individual capacity but solely in its capacity as agent on behalf of and for the benefit of the Lenders.

“Collateral Agent-Related Person” means the Collateral Agent, together with its Affiliates, and the officers, directors, employees, agents, advisors, auditors and attorneys-in-fact of such Persons; provided, however, that no Collateral Agent-Related Person shall be an Affiliate of Borrower.

“Commitment Amount” is set forth in Schedule 1.1, as amended from time to time.

“Commitment Percentage” is set forth in schedule 1.1, as amended from time to time.

“Contingent Obligation” means as applied to any Person, any direct or indirect liability, contingent or otherwise, of that Person with respect to (i) any indebtedness, lease, dividend, letter of credit or other obligation of another; (ii) any obligations with respect to undrawn letters of credit, corporate credit cards, or merchant services issued or provided for the account of that Person; and (iii) all obligations arising under any agreement or arrangement designed to protect such Person against fluctuation in interest rates, currency exchange rates or commodity prices; provided, however, that the term “Contingent Obligation” shall not include endorsements for collection or deposit in the ordinary course of business. The amount of any Contingent Obligation shall be deemed to be an amount equal to the stated or determined amount of the primary obligation in respect of which such Contingent Obligation is made or, if not stated or determinable, the maximum reasonably anticipated liability in respect thereof as determined by Collateral Agent in good faith; provided, however, that such amount shall not in any event exceed the maximum amount of the obligations under the guarantee or other support arrangement.

“Copyrights” means any and all copyright rights, copyright applications, copyright registrations and like protections in each work or authorship and derivative work thereof.

“Credit Card Exposure” has the meaning assigned in Section 2.1(c).

“Credit Card Reserve” has the meaning assigned in Section 2.1(c).

“Credit Card Services” has the meaning assigned in Section 2.1(c).

“Credit Extension” means each Advance, Letter of Credit, use of Credit Card Services, FX Contracts or any other extension of credit by any Lender for the benefit of Borrower hereunder.

“Daily Balance” means the amount of the Obligations owed at the end of a given day.

“Disclosure letter” means the disclosure letter delivered to Lenders by Borrower on the Closing Date, and approved by Lenders.

“Domestic Subsidiary” shall mean any direct or indirect Subsidiary of Borrower incorporated or organized under the laws of the United States of America, or any state or other political subdivision thereof or which is considered to be a “disregarded entity” for United States federal income tax purposes and which is not a “controlled foreign corporation” as defined under Section 957 of the Internal Revenue Code, in each case provided such Subsidiary is owned by Borrower or a Domestic Subsidiary of Borrower, and “Domestic Subsidiaries” shall mean any or all of them.

“Eligible Accounts” means those Accounts that arise in the ordinary course of Borrower’s business that comply with all of Borrower’s representations and warranties to Lenders set forth in Section 5.4; provided, that standards of eligibility may be fixed and revised from time to time by Required Lenders’ in Required Lenders reasonable judgment and upon notification thereof to Borrower in accordance with the provisions hereof. Unless otherwise agreed to by Required Lenders, Eligible Accounts shall not include the following:

(a) Accounts that the account debtor has failed to pay within ninety (90) days of invoice date;

(b) Accounts with respect to an account debtor, thirty five percent (35%) of whose Accounts the account debtor has failed to pay within ninety (90) days of invoice date;

(c) Accounts with respect to which the account debtor is an officer, employee, or agent of Borrower;

(d) Accounts with respect to which goods are placed on consignment, guaranteed sale, sale or return, sale on approval, bill and hold or other terms by reason of which the payment by the account debtor may be conditional;

(e) “Prebilled” accounts, “progress billings” or “retention billings”;

(f) Accounts with respect to which the account debtor is an Affiliate of Borrower;

(g) Accounts with respect to which the Account debtor is Paramit Corporation or Flextronics;

(h) Accounts with respect to which the account debtor does not have its principal place of business in the United States or Canada, except for Eligible Foreign Accounts;

(i) Accounts with respect to which the account debtor is the United States or any department, agency, or instrumentality of the United States;

(j) Accounts with respect to which Borrower is liable to the account debtor for goods sold or services rendered by the account debtor to Borrower or for deposits or other property of the account debtor held by Borrower, but only to the extent of any amounts owing to the account debtor against amounts owed to Borrower;

(k) Accounts with respect to an account debtor, including Subsidiaries and Affiliates, whose total obligations to Borrower exceed thirty percent (30%) of all Accounts, to the extent such obligations exceed the aforementioned percentage, except as approved in writing by Required Lenders;

(l) Accounts that are subject to Borrower’s standard five (5) days rejection or return policy;

(m) Accounts with respect to which the account debtor disputes liability or makes any claim with respect there to as to which Required Lenders believe, in their sole discretion, that there may be a basis for dispute (but only to the extent of the amount subject to such dispute or claim), or is subject to any Insolvency Proceeding, or becomes insolvent, or goes out of business; and

(n) Accounts the collection of which either of the Required Lenders reasonably determines to be doubtful in its reasonable credit judgment.

“Eligible Foreign Accounts” means Accounts with respect to which the account debtor does not have its principal place of business in the United States or Canada and that (i) are supported by one or more letters of credit in an amount and of a tenor, and issued by a financial institution, reasonably acceptable to Required Lenders, or (ii) that Required Lenders approve on a case-by-case basis.

“Eligible Inventory” means Inventory that meets all of Borrower’s representations and warranties in Section 5.5 and is otherwise reasonably acceptable to Required Lenders in all respects.

“Equipment” means all present and future machinery, equipment, tenant improvements, furniture, fixtures, vehicles, tools, parts and attachments in which Borrower has any interest.

“ERISA” means the Employee Retirement Income Security Act of 1974, as amended, and the regulations thereunder.

“Event of Default” has the meaning assigned in Article 8.

“Foreign Exchange Sublimit” means a sublimit for foreign exchange contracts under the Revolving Line not to exceed Two Million Five Hundred Thousand Dollars (\$2,500,000).

“Foreign Subsidiaries” means each Subsidiary of Borrower which is not a Domestic Subsidiary.

“FX Contracts” has the meaning assigned in Section 2.1(d).

“FX Reserve” has the meaning assigned in Section 2.1(d).

“GAAP” means generally accepted accounting principles as in effect from time to time.

“Governmental Authority” means the government of the United States of America or any other nation, or of any political subdivision thereof, whether state or local, and any agency, authority, instrumentality, regulatory body, court, central bank or other entity exercising executive, legislative, judicial, taxing, regulatory or administrative powers or functions of or pertaining to government.

“Guarantor(s)” shall mean each Domestic Subsidiary of Borrower which has executed and delivered to the Collateral Agent a Guaranty (or a joinder to a Guaranty), and a Security Agreement (or a joinder to the Security Agreement).

“Guaranty” shall mean, collectively, the guaranty agreements executed and delivered by the applicable Guarantors from time to time after the Closing Date (whether by execution of joinder agreements or otherwise) pursuant to Section 6.9 hereof or otherwise, in each case in form and substance reasonably acceptable to Collateral Agent, as amended, restated or otherwise modified from time to time.

“Horizon” means Compass Horizon Funding Company LLC.

“Indebtedness” means (a) all indebtedness for borrowed money or the deferred purchase price of property or services, including without limitation reimbursement and other obligations with respect to surety bonds and letters of credit, (b) all obligations evidenced by notes, bonds, debentures or similar instruments, (c) all capital lease obligations and (d) all Contingent Obligations.

“Initial Revenue Cure” has the meaning assigned in Section 6.7.

“Insolvency Proceeding” means any proceeding commenced by or against any person or entity under any provision of the United States Bankruptcy Code, as amended, or under any other bankruptcy or insolvency law,

including assignments for the benefit of creditors, formal or informal moratoria, compositions, extension generally with its creditors, or proceedings seeking reorganization, arrangement, or other relief.

“Inventory” means all inventory in which Borrower has or acquires any interest, including work in process and finished products intended for sale or lease or to be furnished under a contract of service, of every kind and description now or at any time hereafter owned by or in the custody or possession, actual or constructive of Borrower, including such inventory as is temporarily out of its custody or possession or in transit and including any returns upon any accounts or other proceeds, including insurance proceeds, resulting from the sale or disposition of any of the foregoing and any documents of title representing any of the above, and Borrower’s Books relating to any of the foregoing.

“Investment” means any beneficial ownership of (including stock, partnership interest of other securities) any Person, or any loan, advance or capital contribution to any Person.

“Investors” means certain existing investors in Borrower and certain of such investors’ Affiliates.

“Investors’ Indebtedness” means subordinated convertible Indebtedness of Borrower in favor of Investors in the aggregate principal amount not to exceed Fifty Million Dollars (\$50,000,000); provided the same is subject to the Investors Subordination Agreement.

“Investors’ Lien” means a Lien in favor of the Investors, or an agent or representative thereof, to secure repayment of the Investors’ Indebtedness.

“Investors’ Note Purchase Agreement” means that certain [Note Purchase Agreement] by and between Borrower and Investors, pursuant to which Borrower issues to Investors the Investors’ Indebtedness, all instruments and agreements executed and/or delivered in connection therewith, and all schedules and exhibits thereto; all in form and content reasonably acceptable to Lenders.

“Investors Subordination Agreement” means that certain subordination agreement between Investors and Collateral Agent, with respect to the Investors’ Indebtedness, in form and content acceptable to Collateral Agent in its sole discretion; provided that, without limiting the foregoing, the Investors Subordination Agreement shall provide, among other things, that (i) that the Investors’ Indebtedness cannot be repaid before the Obligations under this Agreement are indefeasibly repaid in full, in cash, and the Lenders’ commitments to lend hereunder have been terminated; (ii) interest payable on account of the Investors’ Indebtedness may not be paid currently, or in cash, but must be accrued, if at all as PIK (payment in kind non-cash) interest; and (iii) Investors (nor any agent or any representative of Investors) may not declare a default of the Investors’ Indebtedness or otherwise attempt to accelerate payment of the Investors’ Indebtedness (or otherwise pursue any rights or remedies with respect thereto) unless and until the Obligations under this Agreement are indefeasibly repaid in full, in cash, and the Lenders’ commitments to lend hereunder have been terminated.

“IRC” means the Internal Revenue Code of 1986, as amended, and the regulations thereunder.

“Issuing Lender” means Bridge.

“Lender Expenses” means all: reasonable costs or expenses (including reasonable attorneys’ fees and expenses) incurred in connection with the preparation, negotiation, administration, and enforcement of the Loan Documents; reasonable Collateral audit fees; and Lenders’ reasonable attorneys’ fees and expenses incurred in amending, enforcing or defending the Loan Documents (including fees and expenses of appeal), incurred before, during and after an Insolvency Proceeding, whether or not suit is brought.

“Lien” means any mortgage, lien, deed of trust, charge, pledge, security interest or other encumbrance.

“Letter of Credit” has the meaning set forth in Section 2.1(b)(i).

“Letter of Credit Obligations” mean at any date of determination, the Stated Amount of all outstanding Letters of Credit and unreimbursed payments and disbursements under such Letters of Credit.

“Loan Commitment” means, for any Lender, the obligation of such Lender to make Advances, up to the principal amount shown on Schedule 1.1. “Loan Commitments” means the aggregate amount of such commitments of all Lenders.

“Loan Documents” means, collectively, this Agreement, any note or notes executed by Borrower, and any other agreement entered into in connection with this Agreement, all as amended or extended from time to time.

“Material Adverse Effect” means a material adverse effect on (i) the business operations or condition (financial or otherwise) of Borrower and its Subsidiaries taken as a whole or (ii) the ability of Borrower to repay the Obligations or otherwise perform its obligations under the Loan Documents or (iii) the value or priority of Lenders’ security interests in the Collateral. In determining whether a “Material Adverse Effect” has occurred under clause (i) or (ii) above, Lenders’ primary, though not sole, consideration will be whether Borrower has or will have sufficient cash resources to repay the Obligations as and when due.

“Negotiable Collateral” means all letters of credit of which Borrower is a beneficiary, notes, drafts, instruments, securities, documents of title, and chattel paper, and Borrower’s Books relating to any of the foregoing.

“New Equity” means the receipt by Borrower, after the Closing Date, of net proceeds from the sale and issuance of Borrower’s equity securities or Subordinated Debt (excluding the Investors’ Indebtedness).

“Obligations” means all principal and interest in respect of Advances, Lender Expenses and other amounts owed to Lenders, or any of them, by Borrower pursuant to this Agreement or any other agreement, whether absolute or contingent, due or to become due, now existing or hereafter arising, including any interest that accrues after the commencement of an Insolvency Proceeding (whether or not allowed in such Insolvency Proceeding), and including obligations due in respect of Letters of Credit, Corporate Credit Card Exposure, FX Contracts, and cash management, ACH, overdraft and treasury management services in the ordinary course of business, and including any such debt, liability, or obligation owing from Borrower to others that a Lender may have obtained by assignment or otherwise.

“Patents” means all patents, patent applications and like protections including without limitation improvements, divisions, continuations, renewals, reissues, extensions and continuations-in-part of the same.

“Periodic Payments” means all installments or similar recurring payments that Borrower may now or hereafter become obligated to pay to any Lender pursuant to the terms and provisions of any instrument, or agreement now or hereafter in existence between Borrower and any Lender.

“Permitted Foreign Cash” has the meaning assigned in Section 6.7.

“Permitted Indebtedness” means:

(a) Indebtedness of Borrower in favor of Lenders arising under this Agreement or any other Loan Documents;

(b) Indebtedness existing on the Closing Date and disclosed in the Disclosure Letter;

(c) Indebtedness secured by a lien described in clause (c) of the defined term “Permitted Liens,” provided (i) such Indebtedness does not exceed the lesser of the cost or fair market value of the equipment or other fixed or capital assets financed with such Indebtedness and (ii) such Indebtedness does not exceed \$5,000,000 in the aggregate at any given time; and

(d) the Atel Indebtedness;

(e) Subordinated Debt;

(f) the Venture Debt;

(g) Indebtedness to Oracle America, Inc. or one of its affiliates, including Oracle Credit Corporation, in an aggregate amount not to exceed \$500,000 (the "Oracle Debt");

(h) the Investors' Indebtedness;

(i) Indebtedness constituting (but without duplication with) Investments permitted under clause (h) of the defined term "Permitted Investments;"

(j) Other Indebtedness not otherwise permitted by Section 7.4, not exceeding Five Hundred Thousand Dollars (\$500,000) in the aggregate outstanding at any time; and

(k) extensions, refinancings, modifications, amendments and restatements of any items of Permitted Indebtedness (a) through (g) above, provided that the principal amount thereof is not increased or the terms thereof are not modified to impose more burdensome terms upon Borrower or its Subsidiary, as the case may be.

"Permitted Investment" means:

(a) Investments existing on the Closing Date disclosed in the Disclosure Letter;

(b) (i) marketable direct obligations issued or conditionally guaranteed by the United States of America or any agency of any State thereof maturing within one (1) year from the date of acquisition thereof, (ii) commercial paper maturing more than one (1) year from the date of creation thereof and currently having rating of at least A-2 or P-2 from either Standard & Poor's Corporation or Moody's Investors Service, (iii) certificates of deposit maturing no more than one (1) year from the date of investment therein issued by a Lender; (iv) Lenders' money market accounts; and (v) Investments made in accordance with Borrower's board approved short term investment policy, as provided to, reviewed and approved by Required Lenders (such approval not to be unreasonably withheld or delayed;

(c) Investments consisting of the endorsement of negotiable instruments for deposit or collection or similar transactions in the ordinary course of Borrower;

(d) Investments accepted in connection with Transfers permitted by Section 7.1;

(e) Investments consisting of (i) travel advances and employee relocation loans and other employee loans and advances in the ordinary course of business, and (ii) loans to employees, officers or directors relating to the purchase of equity securities of Borrower or its Subsidiaries pursuant to employee stock purchase plans or agreements approved by Borrower's Board of Directors; not to exceed Two Hundred Fifty Thousand Dollars (\$250,000) in the aggregate in any fiscal year;

(f) Investments (including debt obligations) received in connection with the bankruptcy or reorganization of customers or suppliers and in settlement of delinquent obligations of, and other disputes with, customers or suppliers arising in the ordinary course of business;

(g) Investments consisting of notes receivable of, or prepaid royalties and other credit extensions, to customers and suppliers who are not Affiliates, in the ordinary course of business; provided that this paragraph (g) shall not apply to Investments of Borrower in any Subsidiary;

(h) Investments in Subsidiaries made in the ordinary course of business, not to exceed Four Million Five Hundred Thousand Dollars (\$4,500,000) in the aggregate in any fiscal year;

(i) (x) joint ventures or strategic alliances in the ordinary course of Borrower's business consisting of the nonexclusive licensing of technology, the development of technology or the providing of technical support, provided that any cash investments by Borrower do not exceed Two Hundred Fifty Thousand Dollars (\$250,000) in the aggregate in any fiscal year; and (y) strategic alliances with particular customers in which such customers will share in the research and development expense of Borrower associated with the incorporation by such customers of microconverters purchased from Borrower into solar panels produced by such customers;

(j) Investments in connection with mergers or acquisitions permitted by Section 7.3 and Investments accepted in connection with such mergers or acquisitions permitted by Section 7.3;

(k) Investments permitted pursuant to Section 7.6;

(l) Investments consisting of the conversion or settlement of any convertible securities or debt of Borrower or otherwise in exchange therefor; and

(m) Other Investments aggregating not in excess of One Hundred Fifty Thousand Dollars (\$150,000) at any time.

"Permitted Liens" means the following:

(a) Any Liens existing on the Closing Date and disclosed in the Disclosure Letter or arising under this Agreement or the other Loan Documents;

(b) Liens for taxes fees, assessments or other governmental charges or levies, either not delinquent or being contested in good faith by appropriate proceedings, provided the same have no priority over any of Lenders' security interests;

(c) Liens (i) upon or in any equipment or other fixed or capital assets which was not financed by a Lender acquired or held by Borrower or any of its Subsidiaries to secure the purchase price of such equipment or such fixed or capital assets or indebtedness incurred solely for the purpose of financing the acquisition of such equipment or such fixed or capital assets, or (ii) existing on such equipment at the time of its acquisition, provided that the Lien is confined solely to the property so acquired and improvements thereon, and the proceeds of such equipment;

(d) Liens securing the Atel Indebtedness;

(e) the Investors Lien;

(f) Liens of carriers, warehousemen, suppliers, or other Persons that are possessory in nature arising in the ordinary course of business so long as such Liens attach only to Inventory and which are not delinquent or remain payable without penalty or which are being contested in good faith and by appropriate proceedings which proceedings have the effect of preventing the forfeiture or sale of the property subject thereto;

(g) Liens to secure payment of workers' compensation, employment insurance, old-age pensions, social security and other like obligations incurred in the ordinary course of business (other than Liens imposed by ERISA);

(h) leases or subleases of real property granted in the ordinary course of Borrower's business (or, if referring to another Person, in the ordinary course of such Person's business), and leases, subleases, non-exclusive licenses or sublicenses of personal property (other than Intellectual Property) granted in the ordinary course of Borrower's business (or, if referring to another Person, in the ordinary course of such Person's business), if the leases, subleases, licenses and sublicenses do not prohibit granting Lenders a security interest therein;

(i) non-exclusive license of Intellectual Property granted to third parties in the ordinary course of business, and licenses of Intellectual Property that could not result in a legal transfer of title of the

licensed property that may be exclusive in respects other than territory and that may be exclusive as to territory only as to discreet geographical areas outside of the United States;

(j) Liens arising from attachments or judgments, orders or decrees in circumstances not constituting an Event of Default under Sections 8.4 and 8.7;

(k) Liens in favor of customs and revenue authorities incurred in the ordinary course of business to secure payment of custom duties in connection with the importation of goods;

(l) Liens securing the Venture Debt;

(m) Liens securing the Oracle Debt;

(n) Deposits made in the ordinary course of business to secure Indebtedness for real property lease obligations (provided that any such deposit is in the form of a Letter of Credit issued under this Agreement); and

(o) Liens incurred in connection with the extension, renewal or refinancing of the indebtedness secured by Liens of the type described in clauses (a) through (m) above, provided that any extension, renewal or replacement Lien shall be limited to the property encumbered by the existing Lien and the principal amount of the indebtedness being extended, renewed or refinanced does not increase.

“Person” means any individual, sole proprietorship, partnership, limited liability company, joint venture, trust, unincorporated organization, association, corporation, institution, public benefit corporation, firm, joint stock company, estate, entity or governmental agency.

“Prime Rate” means the greater of (i) the variable rate of interest, per annum, most recently announced by Bridge, as its “prime rate,” whether or not such announced rate is the lowest rate available from Bridge and (ii) 3.25%.

“Pro Rata Share” means, as of any date of determination, with respect to each Lender, a percentage (expressed as a decimal, rounded to the ninth decimal place) determined by dividing the outstanding principal amount of the Advances made by such Lender by the aggregate outstanding principal amount of the Advances.

“Required Lenders” means (i) for so long as all of the Persons that are Lenders on the Closing Date (each an “Original Lender”) have not assigned or transferred any of their interests in their respective Advances, Lenders holding one hundred percent (100%) of the aggregate outstanding principal balance of the Revolving Line, or (ii) at any time from and after any Original Lender has assigned or transferred any interest in its Advances, Lenders holding sixty-six percent (66%) of the aggregate outstanding principal balance of the Revolving Line. For purposes of this definition only a Lender shall be deemed to include itself, and any Lender that is an Affiliate of such Lender.

“Responsible Officer” means each of the Chief Executive Officer, the Chief Operating Officer, the Chief Financial Officer and the Controller of Borrower.

“Revolving Facility” means the facility under which Borrower may request Lenders to issue Advances, as specified in Section 2.1(a) hereof.

“Revolving Line” means a credit extension of up to Twenty Five Million Dollars (\$25,000,000) (inclusive of the aggregate face amount of Letters of Credit, the aggregate limits of the Credit Card Services and any amounts outstanding under the Foreign Exchange Sublimit).

“Revolving Maturity Date” means March 24, 2013.

“Revolving Outstandings” means at any time, the sum of (a) the aggregate amount of the outstanding Advances, (b) the Stated Amount of all Letters of Credit, (c) the Credit Card Reserve, and (d) the FX Reserve in effect from time to time.

“Schedule” means the schedule attached hereto and approved by Required Lenders, if any.

“Security Agreement” shall mean, collectively, the security agreement(s) executed and delivered by the Guarantors on the Closing Date pursuant to Section 3.1(K) hereof, and any such agreements executed and delivered after the Closing Date (whether by execution of a joinder agreement to any existing security agreement or otherwise) pursuant to Section 6.9 hereof or otherwise, in form and substance reasonably acceptable to Collateral Agent, as amended, restated or otherwise modified from time to time.

“Shares” means (i) sixty-five percent (65%) of the issued and outstanding capital stock, membership units or other securities owned or held of record by Borrower in any Subsidiary of Borrower which is not an entity organized under the laws of the United States or any territory thereof, and (ii) one hundred percent (100%) of the issued and outstanding capital stock, membership units or other securities owned or held of record by Borrower in any Subsidiary of Borrower which is an entity organized under the laws of the United States or any territory thereof.

“Stated Amount” means, with respect to any Letter of Credit at any date of determination, (a) the maximum aggregate amount available for drawing thereunder under any and all circumstances, plus (b) the aggregate amount of all unreimbursed payments and disbursements under such Letter of Credit.

“Subordinated Debt” means any debt incurred by Borrower that is subordinated to the debt owing by Borrower to Lenders hereunder or under any of the Loan Documents on terms reasonably acceptable to Collateral Agent (and identified as being such by Borrower and Collateral Agent)

“Subsidiary” means any corporation, company or partnership in which (i) any general partnership interest or (ii) more than 50% of the stock or other units of ownership which by the terms thereof has the ordinary voting power to elect the Board of Directors, managers or trustees of the entity, at the time as of which any determination is being made, is owned by Borrower, either directly or through an Affiliate.

“Tangible Net Worth” means, at any date as of which the amount thereof shall be determined, total assets (less goodwill/intangibles) minus Total Liabilities (which shall include Subordinated Debt, but not the Investors’ Indebtedness), on a consolidated basis determined in accordance with GAAP.

“Total Liabilities” means at any date as of which the amount thereof shall be determined, all obligations that should, in accordance with GAAP, be classified as liabilities on the consolidated balance sheet of Borrower, including in any event all indebtedness; provided that, accrued interest on the Investors’ Indebtedness shall not be included in “Total Liabilities” for purposes of calculating Tangible Net Worth.

“Trademarks” means any trademark and servicemark rights, whether registered or not, applications to register and registrations of the same and like protections, and the entire goodwill of the business of Borrower connected with and symbolized by such trademarks.

“Venture Debt” means indebtedness incurred in favor of Horizon, not to exceed Twelve Million Dollars (\$12,000,000), provided that Horizon has executed an intercreditor agreement with Lenders, in form and content reasonably acceptable to Collateral Agent.

1.2 Accounting Terms. All accounting terms not specifically defined herein shall be construed in accordance with GAAP and all calculations made hereunder shall be made in accordance with GAAP. When used herein, the terms “financial statements” shall include the notes and schedules thereto.

2. LOAN AND TERMS OF PAYMENT.

2.1 Credit Extensions.

Borrower promises to pay to the order of each Lender, in lawful money of the United States of America, the aggregate unpaid principal amount of all Credit Extensions made by such Lender to Borrower hereunder. Borrower shall also pay interest on the unpaid principal amount of such Credit Extensions at rates in accordance with the terms hereof.

(a) Revolving Advances.

(i) Subject to and upon the terms and conditions of this Agreement, Borrower may request, and the Lenders agree, severally and not jointly according to each Lenders' Loan Commitment as forth on Schedule 1.1 hereto, to make Advances in an aggregate outstanding amount not to exceed the lesser of (i) the Revolving Line or (ii) the Borrowing Base, *minus* the Stated Amount of all Letters of Credit, the Credit Card Reserve and the FX Reserve in effect from time to time. Subject to the terms and conditions of this Agreement, amounts borrowed pursuant to this Section 2.1 (a) may be repaid and reborrowed at any time prior to the Revolving Maturity Date, at which time all Advances under this Section 2.1 (a) shall be immediately due and payable. Borrower may prepay any Advances without penalty or premium.

(ii) Whenever Borrower desires an Advance, Borrower will notify each Lender by facsimile transmission or telephone no later than 3.00 p.m. Pacific time on the Business Day that the Advance is to be made. Each such notification shall be promptly confirmed by a Payment/Advance Form in substantially the form of **Exhibit B-1** (with respect to Bridge) and B.2 (with respect to Comerica) hereto. Each Lender is authorized to make Advances under this Agreement, based upon instructions received from a Responsible Officer or a designee of a Responsible Officer, or without instructions if in such Lender's discretion such Advances are necessary to meet Obligations which have become due and remain unpaid. Lenders shall be entitled to rely on any telephonic notice given by a person who a Lender reasonably believes to be a Responsible Officer or a designee thereof, and Borrower shall indemnify and hold Lenders harmless for any damages or loss suffered by any Lender as a result of such reliance. Each Lender will credit the amount of Advances made under this Section 2.1 (a) to Borrower's deposit account maintained with each such Lender.

(b) Letters of Credit.

(i) Commitment. Subject to the terms of this Agreement, at the request of Borrower, Issuing Lender will issue from time to time standby or documentary letters of credit, in each case for the account of Borrower and containing terms and conditions which are consistent with this Agreement and reasonably satisfactory to Issuing Lender (each such letter of credit, a "Letter of Credit") in an aggregate outstanding face amount not to exceed the lesser of the Revolving Line or the Borrowing base *minus* the aggregate amount of the outstanding Advances at any time, the Credit Card Exposure, and the FX Amount, provided that the Stated Amount of all Letters of Credit shall not exceed \$5,000,000. No Letter of Credit shall be issued (including any renewal or extension of any Letter of Credit previously issued) unless: (a) after giving effect to each such issuance, (i) the aggregate Stated Amount of all Letters of Credit shall not at any time exceed \$5,000,000 and (ii) Revolving Outstandings will not at any time exceed the Revolving Line, (b) the conditions set forth in Section 3 have been satisfied, (c) the issuance of the Letter of Credit would not violate one or more policies of the Issuing Lender, and (d) no order, Judgment or decree of any Governmental Authority or arbitrator shall purport by its terms to enjoin or restrain Issuing Lender from issuing the Letter of Credit requested or any Lender from taking an assignment of its Pro Rata Share thereof, and no law, rule, regulation, request or directive (whether or not having the force of law) shall prohibit the Issuing Lender from issuing, or any Lender from taking an assignment of its Pro Rata Share of, the Letter of Credit requested or letters of credit generally, or will impose upon the Issuing Lender any restriction, reserve or capital requirement not in effect on the closing Date and for which the Issuing Lender is not already compensated for hereunder, or will impose on the Issuing Lender unreimbursed loss, cost or expense that was not applicable on the Closing Date deemed to be material to it by the Issuing Lender.

(ii) Application. Borrower shall give notice to Issuing Lender of the proposed issuance of each Letter of Credit on a Business Day which is at least five (5) Business Days prior to the

proposed date of issuance of such Letter of Credit. Each such notice shall be accompanied by a Letter of Credit application (each, an "Application") in Issuing Lender's form, duly executed by Borrower and in all respects reasonably satisfactory to Issuing Lender, together with such other documentation as Issuing Lender may request in support thereof, it being understood that each Application shall specify, among other things, the date on which the proposed Letter of Credit is to be issued, and the expiration date of such Letter of Credit. Issuing Lender shall promptly advise Comerica of the issuance of each Letter of Credit and of any amendment thereto, extension thereof or event or circumstance changing the amount available for drawing thereunder. In the event of any inconsistency between the terms of any Application and the terms of this Agreement with respect to the content of such Application, the terms of such Application shall control. Issuing Lender shall deliver to Comerica upon its request a list of all outstanding Letters of Credit issued by Issuing Lender, together with such information related thereto as Comerica may reasonably request. Unless otherwise expressly agreed to by the Issuing Lender and the Borrower, the rules of the International Standby Practices 98 will apply to each Letter of Credit.

(iii) Reimbursement Obligations.

A. Borrower hereby unconditionally and irrevocably agrees to reimburse Issuing Lender for each payment or disbursement made by Issuing Lender under any Letter of Credit honoring any demand for payment made thereunder, in each case on the date that such payment or disbursement is made. Issuing Lender shall promptly notify Borrower and Comerica whenever any demand for payment is made under any Letter of Credit; provided, that the failure of Issuing Lender to so notify Borrower shall not affect the rights of Issuing Lender or Lenders in any manner whatsoever. Any amount not reimbursed on the date of such payment or disbursement (whether or not through the extension of an Advance pursuant to Section 2.1 (b)(iv)) shall bear interest from the date of such payment or disbursement to the date that Issuing Lender is reimbursed by Borrower therefor, payable on demand, at the interest rate per annum from time to time in effect Advances made by Issuing Lender.

B. Borrower's reimbursement obligations hereunder shall be irrevocable and unconditional under all circumstances, including (i) any lack of validity or enforceability of any Letter of Credit, any Application, this Agreement or any other Loan Document, (ii) the existence of any claim, set off, defense or other right which any Loan Party may have at any time against a beneficiary named in a Letter of Credit, any transferee of any Letter of Credit (or any Person for whom any such transferee may be acting), Issuing Lender, any Lender or any other Person, whether in connection with any Letter of Credit, any Application, this Agreement, any other Loan Document, the transactions contemplated herein or any unrelated transactions (including any underlying transaction between any Lender and the beneficiary named in any Letter of Credit), (iii) the validity, sufficiency or genuineness of any document which Issuing Lender (or, as applicable, the issuer of any underlying letter of credit) has determined complies on its face with the terms of the applicable Letter of Credit (or, if applicable, underlying letter of credit), even if such document should later prove to have been forged, fraudulent, invalid or insufficient in any respect or any statement therein shall have been untrue or inaccurate in any respect, (iv) the surrender or impairment of any security for the performance or observance of any of the terms hereof, (v) any failure, omission, delay or lack on the part of Issuing Lender, any Lender or any party to any of the documents related to the applicable Letter of Credit to enforce, assert or exercise any right, power or remedy conferred upon Issuing Lender, any Lender or any such party under this Agreement, any of the other Loan documents or any of the documents related to the applicable Letter of Credit, or any other acts or omissions on the part of Issuing Lender, any Lender or any such party (vi) payment under a Letter of Credit against presentation of a draft or certificate that does not strictly comply with the terms of the Letter of Credit and (vii) any other event or circumstance whether or not similar to the foregoing including any other circumstance that might otherwise constitute a defense available to, of a discharge of, the Borrower or any Lender, except to the extent such reimbursement obligations result from the gross negligence or willful misconduct of Issuing Lender or any Lender.

(iv) Participations in Letters of Credit.

A. Concurrently with the issuance of each Letter of Credit in accordance with this Agreement, Issuing Lender shall be deemed to have sold and transferred to each other Lender, and each other Lender shall be deemed irrevocably and unconditionally to have purchased and received from Issuing Lender, without recourse or warranty, an undivided interest and participation, to the extent of such Lender's Pro Rata Share in such Letter of Credit and Borrower's reimbursement obligations with respect thereto. If Borrower

does not pay any reimbursement obligation when due, then Borrower shall be deemed to have immediately requested that Lenders make an Advance in a principal amount equal to such reimbursement obligation. The proceeds of such Advance shall be paid over to Issuing Lender for the account of Borrower in satisfaction of such reimbursement obligations.

B. If Issuing Lender makes any payment or disbursement under any Letter of Credit in accordance with this Agreement and (i) Borrower has not reimbursed Issuing Lender in full for such payment or disbursement in accordance with Section 2.1(b)(iii), (ii) an Advance may not, for any reason, be made pursuant to Section 2.1(b)(iv)(A) or (iii) any reimbursement received by Issuing Lender from Borrower is or must be returned or rescinded upon or during any Insolvency Proceeding of any Lender or otherwise each other Lender shall be irrevocably and unconditionally obligated to pay to Issuing Lender, promptly after Issuing Lender's demand, its Pro Rata Share of such payment or disbursement (but no such payment shall diminish the Obligations of Borrower under Section 2.1(b)(iii) or otherwise.

(v) Indemnification of Issuing Lender. Borrower hereby indemnifies and agrees to hold harmless the Lenders and the Issuing Lender and their respective Affiliates, and the respective officers, directors, employees and agents of such Persons (each an "L/G Indemnified Person"), from and against any and all claims, damages, losses, liabilities, costs or expenses of any kind or nature whatsoever which the Lenders or the Issuing Lender or the Collateral Agent or any such Person may incur or which may be claimed against any of them by reason of or in connection with any Letter of Credit collectively, the "L/C Indemnified Amounts"), and none of the Issuing Lender, the Collateral Agent or any Lender or any of their respective officers, directors, employees or agents shall be liable or responsible for:

A. The use which may be made of any Letter of Credit or for any acts or omissions of any beneficiary in connection therewith;

B. the validity, sufficiency or genuineness of documents or of any endorsement thereon, even if such documents should in fact prove to be in any or all respects invalid, insufficient, fraudulent or forged;

C. payment by the Issuing Lender to the beneficiary under any Letter of Credit against presentation of documents which do not strictly comply with the terms of any Letter of Credit (unless such payment resulted from the gross negligence or willful misconduct of the Issuing Lender), including failure of any documents to bear any reference or adequate reference to such Letter of Credit;

D. any error, omission, interruption or delay in transmission, dispatch or delivery of any message or advice, however transmitted, in connection with any Letter of Credit; or

E. any other event or circumstance whatsoever arising in connection with any Letter of Credit.

It is understood that in making any payment under a Letter of Credit the Issuing Lender will rely on documents presented to it under such Letter of Credit as to any and all matters set forth therein without further investigation and regardless of any notice or information to the contrary.

With respect to subparagraphs (A) through (E) of this subsection (v), (i) Borrower shall not be required to indemnify any L/C Indemnified Person for any L/C Indemnified Amounts to the extent such amounts result from the gross negligence or willful misconduct of such L/C Indemnified Person, and (ii) the Issuing Lender shall be liable to Borrower to the extent but only to the extent, of any direct, as opposed to consequential or incidental, damages suffered by Borrower which were caused by the gross negligence or willful misconduct of the Issuing Lender or any officer, director, employee or agent of the Issuing Lender or by the Issuing Lender's wrongful dishonor of any Letter of Credit after the presentation to it by the beneficiary thereunder of a draft or other demand for payment and other documentation strictly complying with the terms and conditions of such Letter of Credit.

(c) Corporate Credit Cards. Borrower may obtain corporate credit cards ("Credit card Services") issued for its account from Bridge, provided that the aggregate limit of such corporate credit cards

issued by Bridge (“Credit Card Exposure”) shall not exceed \$100,000 at any time outstanding. A reserve (“Credit Card Reserve”) shall be established against availability under the Borrowing Base in the maximum amount of the Credit Card Exposure. The terms and conditions (including repayment and fees) of such Credit Card Services shall be subject to the terms and conditions of Bridge’s standard forms of application and agreement for the Credit Card Services, which Borrower hereby agrees to execute as a condition precedent to the use of the Credit Card Services. All corporate credit cards will be cancelled on and no further Credit Card Services will be provided after the Revolving Maturity Date.

(d) Foreign Exchange Sublimit. Subject to and upon the terms and conditions of this Agreement and any other agreement that Borrower may enter into with any Lender in connection with foreign exchange transactions (“FX Contracts”), Borrower may request that a Lender agree severally and not jointly, to enter into FX Contracts with Borrower expiring not later than the Revolving Maturity Date, and a Lender may agree (if it so elects) to do so (provided that no Lender shall have any obligation to enter into FX Contracts). Borrower shall pay any standard issuance and other fees that each Lender notifies Borrower will be charged for issuing and processing FX Contracts for Borrower. The aggregate FX Amount shall at all times be equal to or less than Two Million Five Hundred Thousand Dollars (\$2,500,000) for all FX Contracts entered into with Lenders hereunder. In addition, no single Lender shall have an aggregate FX Amount in excess of \$1,250,000. The “FX Amount” shall equal the amount determined by multiplying (i) the aggregate amount in United States Dollars, of FX Contracts between Borrower and any participating Lender remaining outstanding as of any date of determination by (ii) the applicable Foreign Exchange Reserve percentage as of such date. The “Foreign Exchange Reserve Percentage” shall be a percentage as determined by each Lender, in its sole discretion from time to time. The initial Foreign Exchange Reserve Percentage shall be ten percent (10%). A reserve (the “FX Reserve”) shall be established against availability under the Borrowing Base in the aggregate FX Amount in effect from time to time. Each Lender shall advise the other Lenders and the Collateral Agent in writing promptly upon entering into an FX Contract with Borrower (with a copy to Borrower), specifying in such notice the FX Amount related to such Contract. Lenders shall be entitled to receive collection proceeds under Section 9.4 in respect of FX Contracts entered into by it with Borrower up to the amount of the FX Reserve applicable to such FX Contracts (until the amount of such reserve has been exhausted) in the chronological order in which such contracts have been entered into. Once the amount of the FX Reserve has been exhausted, no additional collection proceeds shall be available for application against the Borrower’s Obligations under FX Contracts until all other Obligations have been paid and discharged in full.

(e) Collateralization of Obligations Extending Beyond Maturity. If Borrower has not secured to the relevant Lender satisfaction Borrower’s obligations with respect to any Letters of Credit, Credit Card Services, or FX Contracts that may extend beyond the Revolving Maturity Date, then, effective as of the Revolving Maturity Date the balance in any deposit accounts held by any such issuing Lender and the certificates of deposit or time deposit accounts issued by such Lender in Borrower’s name (and any interest paid thereon or proceeds thereof, including any amounts payable upon the maturity or liquidation of such certificates or accounts), shall automatically secure such obligations to the extent of the then continuing or outstanding Stated Amount of Letters of Credit, Credit Card Services or FX Contracts; provided, however, that if there are insufficient balances in such accounts to secure such obligations, Borrower shall immediately deposit such additional funds in the relevant Lenders, accounts as are necessary to fully secure such obligations. Borrower authorizes each Lender to hold such balances in pledge and to decline to honor any drafts thereon or any requests by Borrower or any other Person to pay or otherwise transfer any part of such balances for so long as the Letters of Credit, Credit Card Services or FX Contracts are outstanding or continue.

2.2 Overadvances. If the Revolving Outstandings exceeds the lesser of the Revolving Line of the Borrowing Base at any time, Borrower shall immediately pay to Lenders, in cash, each Lender’s Pro Rata Share of the amount of such excess, for application against the outstanding Advances, or to be held as cash collateral.

2.3 Interest Rates, Payments, and Calculations.

(a) Interest Rate for Advances. Except as set forth in Section 2.3(b), the Advances shall bear interest, on the outstanding Daily Balance thereof, at a rate equal to one and one quarter percent (1.25%) above the Prime Rate.

(b) Late Fee; Default Rate. If any payment is not made within ten (10) days after the date such payment is due, Borrower shall pay Lenders a late fee equal to the lesser of (i) five percent (5%) of the amount of such unpaid amount or (ii) the maximum amount permitted to be charged under applicable law, not in any case to be less than \$25.00. All Obligations shall bear interest, from and after the occurrence and during the continuance of an Event of Default, at a rate equal to five (5) percentage points above the interest rate applicable immediately prior to the occurrence of the Event of Default.

(c) Payments. Interest hereunder shall be due and payable on the tenth-(10th) calendar day of each month during the term hereof. Lenders shall, at their option, charge such interest, all Lender Expenses, and all Periodic Payments against any of Borrower's deposit accounts maintained with such Lender or against the Revolving Line, in which case those amounts shall thereafter accrue interest at the rate then applicable hereunder. Any interest not paid when due shall be compounded by becoming a part of the Obligations, and such interest shall thereafter accrue interest at the rate then applicable hereunder. All payment shall be free and clear of any taxes, withholdings, duties, impositions or other charges, to the end that Lenders will receive the entire amount of any Obligations payable hereunder, regardless of source of payment.

(d) Computation. In the event the Prime Rate is changed from time to time hereafter, the applicable rate of interest hereunder shall be increased or decreased, effective as of the day the Prime Rate is changed, by an amount equal to such change in the Prime Rate. All interest chargeable under the Loan Documents shall be computed on the basis of a three hundred sixty (360) day year for the actual number of days elapsed.

(e) Remittances; Lockbox Account Collection Services. Within sixty (60) days after the Closing Date and at all times thereafter, Borrower shall (i) notify, transfer and deliver to Bridge all payments in respect of Accounts Borrower receives (other than the Permitted Foreign Cash), and (ii) enter into a collection services agreement reasonably acceptable to Bridge (the "Lockbox Agreement"). Borrower shall use the lockbox address as the remit to and payment address for all of Borrower's Accounts (other than the Permitted Foreign Cash) and it will be considered an immediate Event of Default if this does not occur or the lockbox is not operational within sixty (60) days of the Closing Date. Prior to the establishment of the Lockbox Account, Borrower may continue to use the remote deposit check scanner to deposit checks to Borrower's operating account maintained with Bridge. Notwithstanding the foregoing, Lenders acknowledge and agree that Borrower's non-U.S. customers shall send payments to Borrower's foreign subsidiaries, which will subsequently (other than the Permitted Foreign Cash) (but within five (5) days of receipt thereof) remit payments of Borrower on account of Accounts receivable through the lockbox. Prior to the occurrence of an Event of Default, all amounts received to the Lockbox Account or otherwise received by Bridge shall be credited to Borrower's operating account with Bridge; after the occurrence and during the continuance of an Event of Default, Bridge may apply such amounts to the Obligations in the Lender's sole discretion subject to Lenders' rights to receive ratable distributions in respect of the Obligations owing to it in accordance with Section 9.4.

2.4 Crediting Payments. Prior to the occurrence of an Event of Default, each Lender shall credit a wire transfer of funds, check or other item of payment to such deposit account or Obligation as Borrower specifies. After the occurrence and during the continuance of an Event of Default, the receipt by a Lender of any wire transfer of funds, check, or other item of payment shall be promptly applied to conditionally reduce Obligations, but shall not be considered a payment on account unless such payment is of immediately available federal funds or unless and until such check or other item of payment is honored when presented for payment. Notwithstanding anything to the contrary contained herein, any wire transfer or payment received by a Lender after 12.00 noon Pacific time shall be deemed to have been received by such Lender as of the opening of business on the immediately following Business Day. Whenever any payment to a Lender under the Loan Documents would otherwise be due (except by reason of acceleration) on a date that is not a Business Day, such payment shall instead be due on the next Business Day, and additional fees or interest, as the case may be, shall accrue and be payable for the period of such extension.

2.5 Fees. Borrower shall pay to Lenders the following:

(a) Facility Fee. On the Closing Date and the first anniversary thereof, a facility fee equal to One Hundred Thousand Dollars (\$100,000), to be shared between the Lenders pursuant to their respective Commitment Percentages, which shall be nonrefundable; and

(b) Letter of Credit Fees.

(i) Borrower agrees to pay to Issuing Lender on demand, for the account of each Lender according to such Lender's Pro Rata Share (as adjusted from time to time), any fees as to each Letter of Credit as have been agreed to by Borrower and Lenders.

(ii) In addition, with respect to each Letter of Credit, Borrower agrees to pay to Issuing Lender, for its own account, (i) such fees and reasonable out-of-pocket expenses as Issuing Lender customarily requires (or, as the case may be, is required to pay to the issuer of the letter of credit) in connection with the issuance, negotiation, processing and/or administration of letters of credit in similar situations and (ii) a letter of credit fronting fee in the amount and at the times agreed to by Borrower and Issuing Lender.

(c) Lender Expenses. On the Closing Date, all Lender Expenses incurred through the Closing Date, including reasonable attorneys' fees and expenses and, after the Closing Date, all Lender Expenses, including reasonable attorneys' fees and expenses, as and when they are incurred by Bank.

2.6 Term. This Agreement shall become effective on the Closing Date and, subject to Section 12.7, shall continue in full force and effect for so long as any Obligations (other than inchoate indemnity obligations) remain outstanding or any Lender has any obligation to make Credit Extensions under this Agreement. Notwithstanding the foregoing, Lenders shall have the right to terminate their obligation to make Credit Extensions under this Agreement immediately and without notice upon the occurrence and during the continuance of an Event of Default. Notwithstanding termination, Lenders' Liens on the Collateral shall remain in effect for so long as any Obligations (other than inchoate indemnity obligations) are outstanding.

2.7 Administration. Lenders have elected to administer this Agreement without designating an administrative agent. To facilitate the administration of this Agreement, each Lender agrees (but without liability to Borrower or the other Lenders for failing to do so) to advise the other Lenders promptly of any Advances, Letters of Credit or FX Contracts made, issued or entered into by it, and of any payments received by it (whether voluntary payments, setoff amounts, automatic payments by debit to accounts maintained by borrower with it or otherwise). Furthermore, to the extent Advances properly made by any Lender exceed the amounts which should have been funded or carried by such Lender, as the case may be, based on its applicable Loan Commitment, the other Lenders shall (to the extent such Lenders have not funded or are not carrying outstanding Advances based on their applicable Loan Commitment) purchase participations in such overfunded Lender's Advances (or otherwise adjust the amount of their outstandings by mutual agreement), until the amount of such overfunding has been eliminated.

3. CONDITIONS OF LOANS.

3.1 Conditions Precedent to Initial Credit Extension. The obligation of each Lender to make the initial Credit Extension is subject to the condition precedent that Lenders shall have received, in form and substance satisfactory to Lenders, the following:

(a) this Agreement;

(b) a certificate of the Secretary of Borrower with respect to incumbency and resolutions authorizing the execution and delivery of this

Agreement;

(c) UCC National Form Financing Statement Amendment;

(d) an Amended and Restated Intercreditor Agreement, duly executed by ATEL with respect to the ATEL Indebtedness;

- (e) an Amended and Restated Intercreditor Agreement, duly executed by Horizon with respect to the Venture Debt;
- (f) (i) agreement to provide insurance and (ii) insurance authorization letter in the forms attached hereto;
- (g) payment of the fees and Lender Expenses then due specified in Section 2.5 hereof;
- (h) current financial statements of Borrower;
- (i) an audit of the Collateral, the results of which shall be satisfactory to Lenders; and
- (j) such other documents, and completion of such other matters, as Lenders may reasonably deem necessary or appropriate.

3.2 Conditions Precedent to all Credit Extensions. The obligation of Lenders to make each Credit Extension, including the initial Credit Extension, is further subject to the following conditions:

(a) timely receipt by each Lender of the Payment/Advance Form as provided in Section 2.1; and

(b) the representations and warranties contained in Section 5 shall be true and correct in all material respects on and as of the date of such Payment/Advance Form and on the effective date of each Credit Extension as though made at and as of each such date, and no Event of Default shall have occurred and be continuing, or would exist after giving effect to such Credit Extension (provided, however, that those representations and warranties expressly referring to another date shall be true, correct and complete in all material respects as of such date). The making of each Credit Extension shall be deemed to be a representation and warranty by Borrower on the date of such Credit Extension as to the accuracy of the facts referred to in this Section 3.2.

4. CREATION OF SECURITY INTEREST.

4.1 Grant of Security Interest. Borrower grants and pledges to Collateral Agent, for the ratable benefit of each Lender, a continuing security interest in all presently existing and hereafter acquired or arising Collateral in order to secure prompt repayment of any and all Obligations and in order to secure prompt performance by Borrower of each of its covenants and duties under the Loan Documents. Except as set forth in the Disclosure Letter, such security interest constitutes a valid, first priority security interest in the presently existing Collateral, and will constitute a valid, first priority security interest in Collateral acquired after the date hereof.

4.2 Delivery of Additional Documentation Required. Borrower shall from time to time execute and deliver to the Collateral Agent, at the request of any Lender, all Negotiable Collateral, all financing statements and other documents that such Lender may reasonably request, in form reasonably satisfactory to Required Lenders, to perfect and continue the perfection of Lenders' security interests in the Collateral and in order to fully consummate all of the transactions contemplated under the Loan Documents. Subject to the requirements of Sections 6.7 and 9.4, Borrower from time to time may deposit with each Lender specific time deposit accounts to secure specific Obligations.

4.3 Right to Inspect. Collateral Agent and the Lenders (through any of its officers, employees, or agents) shall have the right, upon reasonable prior notice and at Borrower's sole expense, from time to time during Borrower's usual business hours but no more than twice a year (unless an Event of Default has occurred and is continuing), to inspect Borrower's Books and to make copies thereof and to check, test, and appraise the Collateral in order to verify Borrower's financial condition or the amount, condition of, or any other matter relating to the Collateral.

4.4 Pledge of Collateral. To the extent permitted by applicable law and the terms and conditions governing the Shares, Borrower hereby pledges, assigns and grants to Collateral Agent, for the ratable benefit of each Lender, a security interest in all the Shares, together with all proceeds and substitutions thereof, all cash, stock and other moneys and property paid thereon, all rights to subscribe for securities declared of granted in connection therewith, and all other cash and noncash proceeds of the foregoing, as security for the performance of the Obligations. To the extent permitted by applicable law and the terms and conditions governing the Shares, within sixty (60) days of the Closing Date, the certificate or certificates for the Shares will be delivered to Collateral Agent, accompanied by an instrument of assignment duly executed in blank by Borrower. To the extent required by the terms and conditions governing the Shares, Borrower shall cause the books of each entity whose Shares are part of the Collateral and any transfer agent to reflect the pledge of any applicable Shares. Upon the occurrence and during the continuance of an Event of Default hereunder, Collateral Agent, for the ratable benefit of each Lender, may effect the transfer of any securities included in the Collateral (including but not limited to the Shares) into the name of Collateral Agent and cause new certificates representing such securities to be issued in the name of Collateral Agent or its transferee. Borrower will execute and deliver such documents, and take or cause to be taken such actions, as Collateral Agent may reasonably request to perfect or continue the perfection of Collateral Agent's security interest in the Shares. Unless an Event of Default shall have occurred and be continuing, Borrower shall be entitled to exercise any voting rights with respect to the Shares and to give consents, waivers and ratifications in respect thereof, provided that no vote shall be cast or consent, waiver or ratification given or action taken which would be inconsistent with any of the terms of this Agreement or which would constitute or create any violation of any of such terms. All such rights to vote and give consents, waivers and ratifications shall terminate upon the occurrence and continuance of an Event of Default.

5. REPRESENTATIONS AND WARRANTIES.

Borrower represents and warrants as follows:

5.1 Due Organization and Qualification. Borrower and each Subsidiary is a corporation duly existing under the laws of its state of incorporation and qualified and licensed to do business in any state in which the conduct of its business or its ownership of property requires that it be so qualified.

5.2 Due Authorization; No Conflict. The execution, delivery, and performance of the Loan Documents are within Borrower's powers, have been duly authorized, and are not in conflict with nor constitute a breach of any provision contained in Borrower's Articles of Incorporation or Bylaws, nor will they constitute an event of default under any material agreement to which Borrower is a party or by which Borrower is bound. Borrower is not in default under any material agreement to which it is a party or by which it is bound.

5.3 No Prior Encumbrances. Borrower has good and marketable title to its property, free and clear of Liens, except for Permitted Liens.

5.4 Bona Fide Eligible Accounts. The Eligible Accounts are bona fide existing obligations. The property and services giving rise to such Eligible Accounts has been delivered or rendered to the account debtor or to the account debtor's agent for immediate and unconditional acceptance by the account debtor. Borrower has not received notice of actual or imminent Insolvency Proceeding of any account debtor that is included in any Borrowing Base Certificate as an Eligible Account.

5.5 Merchantable Inventory; Eligible Inventory. All Inventory is in all material respects of good and marketable quality free from all material defects, except for Inventory for which adequate reserves have been made. For any item of Inventory consisting of "Eligible Inventory" in any Borrowing Base Certificate, such Inventory (a) consists of finished goods, in good, new, and merchantable condition, which is not perishable, in transit, returned, consigned, obsolete, not merchantable, damaged, or defective, and is not comprised of demonstrative or custom inventory, works in progress, packaging or shipping materials, or supplies; (b) meets all applicable standards established by any applicable Governmental Authority having regulatory authority over such Inventory; (c) has been manufactured in compliance with the applicable Fair Labor Standards Act with respect to such Inventory; (d) is not subject to any Liens, except the first priority Liens granted or in favor of Lenders under this Agreement or any of the other Loan Documents and Permitted Liens; and (e) is located only in the United

States, and, in the case of Inventory in the possession of any third party, Lenders have received written acknowledgment of Lenders' prior lien therein, in form and content reasonably acceptable to Required Lenders.

5.6 Intellectual Property. Borrower is the sole owner of the Intellectual Property, except for non-exclusive licenses granted by Borrower to its customers in the ordinary course of business. Each of the Patents is valid and enforceable, and no part of the Intellectual Property has been judged invalid or unenforceable, in whole or in part, and to the best of Borrower's knowledge, no claim has been made that any part of the Intellectual Property violates the rights of any third party. Except as set forth in the Disclosure Letter, Borrower is not a party to, or bound by, any agreement that restricts the grant by Borrower of a security interest in Borrower's rights under such agreement.

5.7 Name; Location of Chief Executive Office. Except as disclosed in the Disclosure Letter, Borrower has not done business under any name other than that specified on the signature page hereof. As of the date hereof, the chief executive office of Borrower is located at the address indicated in Section 10 hereof. All Borrower's Inventory and Equipment with an aggregate value in excess of \$50,000 is located only at Flextronics (international or domestic locations; subject to a bailee agreement (over domestic Inventory) in form and content reasonably acceptable to Required Lenders) or the location set forth in Section 10 hereof or in the Disclosure Letter.

5.8 Litigation. Except as set forth in the Disclosure Letter, there are no actions or proceedings pending by or against Borrower or any Subsidiary before any court or administrative agency in which an adverse decision could have a Material Adverse Effect or a material adverse effect on Borrower's interest or Lenders' security interest in the Collateral.

5.9 No Material Adverse Change in Financial Statements. All consolidated and consolidating financial statements related to Borrower and any Subsidiary that Lenders have received from Borrower fairly present in all material respects Borrower's financial condition as of the date thereof and Borrower's consolidated and consolidating results of operations for the period then ended. There has not been a material adverse change in the consolidated or the consolidating financial condition of Borrower since the date of the most recent of such financial statements submitted to Lenders.

5.10 Solvency, Payment of Debts. Borrower is able to pay its debts (including trade debts) as they mature.

5.11 Regulatory Compliance. Borrower and each Subsidiary have met the minimum funding requirements of ERISA with respect to any employee benefit plans subject to ERISA, and no event has occurred resulting from Borrower's failure to comply with ERISA that could result in Borrower's incurring any material liability. Borrower is not an "investment company" or a company "controlled" by an "investment company" within the meaning of the Investment Company Act of 1940. Borrower is not engaged principally, or as one of the important activities, in the business of extending credit for the purpose of purchasing or carrying margin stock (within the meaning of Regulations T and U of the Board of Governors of the Federal Reserve System). Borrower has complied with all the provisions of the Federal Fair Labor Standards Act. Borrower has not violated any statutes, laws, ordinances or rules applicable to it, violation of which could have a Material Adverse Effect.

5.12 Environmental Condition. Except as disclosed in the Disclosure Letter, none of Borrower's or any Subsidiary's properties or assets has ever been used by Borrower or any Subsidiary or, to the best of Borrower's knowledge, by previous owners or operators, in the disposal of, or to produce, store, handle, treat, release or transport, any hazardous waste or hazardous substance other than in accordance with applicable law; to the best of Borrower's knowledge, none of Borrower's properties or assets has ever been designated or identified in any manner pursuant to any environmental protection statute as a hazardous waste or hazardous substance disposal site or a candidate for closure pursuant to any environmental protection statute; no lien arising under any environmental protection statute has attached to any revenues or to any real or personal property owned by Borrower or any Subsidiary, and neither Borrower nor any Subsidiary has received a summons, citation, notice, or directive from the Environmental Protection Agency or any other federal, state or other governmental agency concerning any action or omission by Borrower or any Subsidiary resulting in the releasing, or otherwise disposing of hazardous waste or hazardous substances into the environment.

5.13 Taxes. Borrower and each Subsidiary have filed or caused to be filed all material tax returns required to be filed, and have paid, or have made adequate provision for the payment of, all material taxes reflected therein.

5.14 Subsidiaries. Borrower does not own any stock, partnership interest or other equity securities of any Person, except for Permitted Investments.

5.15 Government Consents. Borrower and each Subsidiary have obtained all material consents, approvals and authorizations of, made all declarations or filings with, and given all notices to, all governmental authorities that are necessary for the continued operation of Borrower's business as currently conducted.

5.16 Accounts. Except as set forth in Section 6.7, none of Borrower's nor any Subsidiary's cash or investment property is maintained or invested with a Person other than Lenders.

5.17 Shares. Borrower has full power and authority to create a first lien on any Shares pledged and delivered to Collateral Agent and no disability or contractual obligation exists that would prohibit Borrower from pledging the Shares pursuant to this Agreement. To Borrower's knowledge, there are no subscriptions, warrants, rights of first refusal or other restrictions on transfer relative to, or options exercisable with respect to the Shares. The Shares have been and will be duly authorized and validly issued, and are fully paid and non-assessable. To Borrower's knowledge, the Shares are not the subject of any present or threatened in writing suit, action, arbitration, administrative or other proceeding, and Borrower knows of no reasonable grounds for the institution of any such proceedings.

5.18 Full Disclosure. No representation, warranty or other statement made by Borrower in any certificate or written statement furnished to any Lender contains any untrue statement of a material fact or omits to state a material fact necessary in order to make the statements contained in such certificates or statements not misleading.

6. AFFIRMATIVE COVENANTS.

Borrower shall do all of the following:

6.1 Good Standing. Borrower shall maintain its and each of its Subsidiaries' corporate existence and good standing in its jurisdiction of incorporation and maintain qualification in each jurisdiction in which it is required under applicable law. Borrower shall maintain, and shall cause each of its Subsidiaries to maintain, in force all licenses, approvals and agreements, the loss of which could have a Material Adverse Effect.

6.2 Government Compliance. Borrower shall meet, and shall cause each Subsidiary to meet, the minimum funding requirements of ERISA with respect to any employee benefit plans subject to ERISA. Borrower shall comply, and shall cause each Subsidiary to comply, with all statutes, laws, ordinances and government rules and regulations to which it is subject, noncompliance with which could have a Material Adverse Effect.

6.3 Financial Statements, Reports, Certificates. Borrower shall deliver the following to Lenders: (a) (i) as soon as available, but in any event within thirty (30) days after the end of each calendar month, a company prepared consolidated balance sheet, income statement, and cash flow statement covering Borrower's consolidated operations during such period, prepared in accordance with GAAP, consistently applied, in a form acceptable to Lenders and certified by a Responsible Officer; and (ii) as soon as available, but in any event within thirty (30) days after the end of each calendar quarter, a company prepared consolidating balance sheet, income statement, and cash flow statement covering Borrower's consolidating operations during such period, prepared in accordance with GAAP, consistently applied, in a form acceptable to Lenders and certified by a Responsible Officer; (b) as soon as available, but in any event within one hundred eighty (180) days after the end of Borrower's fiscal year (beginning with the 2010 fiscal year), audited consolidated financial statements of Borrower prepared in accordance with GAAP, consistently applied, together with an unqualified opinion (other than a qualification for a

going concern) on such financial statements of an independent certified public accounting firm reasonably acceptable to Required Lenders; (c) copies of all statements, reports and notices sent or made available generally by Borrower to its security holders or to any holders of Subordinated Debt and, if applicable, all reports on Forms 10-K and 10-Q filed with the Securities and Exchange Commission; (d) promptly upon receipt of notice thereof, a report of any legal actions pending or threatened against Borrower or any Subsidiary that could result in damages or costs to Borrower or any Subsidiary of Two Hundred Fifty Thousand Dollars (\$250,000) or more; (e) such budgets, sales projections, operating plans or other financial information as any Lender may reasonably request from time to time including, as soon as available, but in any event no later than thirty (30) days after the end of Borrower's fiscal year, an annual operating budget approved by Borrower's board of directors; and (f) (i) within thirty (30) days of the last day of each year, a report signed by Borrower, in form reasonably acceptable to Lenders, listing any applications or registrations that Borrower has made or filed in respect of any Patents, Copyrights of Trademarks and the status of any outstanding applications or registrations, as well as any material change in Borrower's intellectual property and (ii) promptly after filing, written notice of the filing of any applications or registrations with the United States Patent and Trademark Office and the United States Copyright Office, including the date of such filing and the registration or application numbers, if any.

Within twenty (20) days after the last day of each month, Borrower shall deliver to Lenders a Borrowing Base Certificate signed by a Responsible Officer in substantially the form of **Exhibit C** hereto, together with (i) aged listings of accounts receivable and accounts payable, and (ii) perpetual inventory reports for the Inventory valued on a first-in, first-out basis at the lower of cost or market (in accordance with GAAP) and/or such other inventory reports as are requested by Lenders in their good faith business judgment.

Borrower shall deliver to Lenders with the monthly financial statements a Compliance Certificate signed by a Responsible Officer in substantially the form of **Exhibit D** hereto and a deferred revenue report.

Lenders shall have a right from time to time hereafter (x) to audit Borrower's Accounts, provided that such audits will be conducted (i) within thirty (30) days of the Closing Date; and (ii) no more often than every six (6) months thereafter unless an Event of Default has occurred and is continuing; and (y) to appraise Collateral (including but not limited to the Inventory) (i) prior to any Advance against the "Eligible Inventory;" and (ii) every twelve (12) months thereafter unless an Event of Default has occurred and is continuing; in each case of (x) and (y), at Borrower's expense.

6.4 Inventory; Returns. Borrower shall keep all Inventory in good and marketable condition, free from all material defects except for Inventory for which adequate reserves have been made. Returns and allowances, if any as between Borrower and its account debtors shall be on the same basis and in accordance with the usual customary practices of Borrower, as they exist at the time of the execution and delivery of this Agreement. Borrower shall promptly notify Lenders of all returns and recoveries and of all disputes and claims, where the return, recovery, dispute or claim involves more than Two Hundred Fifty Thousand Dollars (\$250,000).

6.5 Taxes. Borrower shall make, and shall cause each Subsidiary to make, due and timely payment or deposit of all material federal, state, and local taxes, assessments, or contributions required of it by law, and will execute and deliver to Lenders, on demand, appropriate certificates attesting to the payment or deposit thereof; and Borrower will make, and will cause each Subsidiary to make, timely payment or deposit of all material tax payments and withholding taxes required of it by applicable laws, including, but not limited to, those laws concerning F.I.C.A., F.U.T.A., state disability, and local, state, and federal income taxes, and will, upon request, furnish Lenders with proof reasonably satisfactory to Lenders indicating that Borrower or a Subsidiary has made such payments or deposits, provided that Borrower or a Subsidiary need not make any payment if the amount or validity of such payment is contested in good faith by appropriate proceedings and is reserved against (to the extent required by GAAP) by Borrower.

6.6 Insurance.

(a) Borrower, at its expense, shall keep the Collateral insured against loss or damage by fire theft, explosion, sprinklers, and all other hazards and risks, and in such amounts, as ordinarily insured against by other owners in similar businesses conducted in the locations where Borrower's business is

conducted on the date hereof. Borrower shall also maintain insurance relating to Borrower's business, ownership and use of the Collateral in amounts and of a type that are customary to businesses similar to Borrower's.

(b) All such policies of insurance shall be in such form with such companies, and in such amounts as are reasonably satisfactory to Collateral Agent. All such policies of property insurance shall contain a lender's loss payable endorsement, in a form reasonably satisfactory to Collateral agent, showing each Lender as an additional loss payee thereof, and all liability insurance policies shall show each Lender as an additional insured and shall specify that the insurer must give at least twenty (20) days notice to Collateral Agent before canceling its policy for any reason. Upon any Lenders' request, Borrower shall deliver to Lenders certified copies of such policies of insurance and evidence of the payments of all premiums therefor. All proceeds payable under any such policy shall, at the option of Lenders, be payable to Collateral Agent, for the benefit of the Lenders according to their Pro Rata Share, to be applied on account of the Obligations.

6.7 Accounts. Borrower shall maintain (x) its primary operating accounts with Bridge, which accounts shall represent at least 50% of the dollar value of Borrower's accounts at all financial institutions; (y) at least 30% of the dollar value of Borrower's accounts at all financial institutions with Comerica; and (z) at least One Million Dollars (\$1,000,000) in a non interest-bearing demand deposit account with each of Bridge and Comerica; provided that (i) in the event Borrower obtains an advance of the Investors' Indebtedness, Borrower shall maintain at least Two Million Dollars (\$2,000,000) in a non interest-bearing demand deposit account with each of Bridge and Comerica; (ii) in the event Borrower's quarterly revenue is less than eighty percent (80%) of Borrower's Board-approved forecast submitted to Lenders in accordance with Section 6.3 (the "Approved Forecast"), Borrower shall, until such time as Borrower achieves and maintains two (2) consecutive quarters of quarterly revenue equal to or greater than eighty percent (80%) of the Approved Forecast (the "Initial Revenue Cure"), maintain consolidated, unrestricted cash in a non interest-bearing demand deposit account with Bridge in the amount of at least Three Million Dollars (\$3,000,000) (or, Four Million Dollars (\$4,000,000) in the event Borrower has obtained an advance of the Investors' Indebtedness), and with Comerica in the amount of at least Two Million Dollars (\$2,000,000) (or, Three Million Dollars (\$3,000,000) in the event Borrower has obtained an advance of the Investors' Indebtedness); provided that, in the event that, after the Initial Revenue Cure, Borrower's quarterly revenue is less than eighty percent (80%) of the Approved Forecast, Borrower shall at all times thereafter maintain consolidated, unrestricted cash in a non interest-bearing demand deposit account with Bridge in the amount of at least Three Million Dollars (\$3,000,000) (or, Four Million Dollars (\$4,000,000) in the event Borrower has obtained an advance of the Investors' Indebtedness), and with Comerica in the amount of at least Two Million Dollars (\$2,000,000) (or, Three Million Dollars (\$3,000,000) in the event Borrower has obtained an advance of the Investors' Indebtedness); (iii) Borrower may continue to maintain its existing account with Bank of the West with a balance not to exceed Five Thousand Dollars (\$5,000) (with respect to which a control agreement shall not be required); (iv) Borrower may maintain up to five percent (5.00%) of consolidated cash in its existing accounts held outside the United States to support Borrower's Foreign Subsidiaries ("Permitted Foreign Cash"), provided that if amounts in such accounts exceed five percent (5.00%) of consolidated cash, Borrower shall, within five (5) calendar days, cause such excess amount to be transferred to an account with Bridge or Comerica; and (v) Borrower shall not, and shall not permit any Subsidiary, to open any accounts other than those described herein, without Required Lenders' prior written consent (which consent shall not be unreasonably withheld).

6.8 Financial Covenants. Borrower shall at all times maintain the following financial covenants and ratios:

(a) **Asset Coverage Ratio.** A ratio of (a) unrestricted cash at Lenders (and at financial institutions (permitted in accordance with Section 6.7) subject to control agreements in favor of, and in form and content reasonably acceptable to, Collateral Agent, for the ratable benefit of the Lenders (including that amounts subject to such accounts must be credited first to accounts with either Lender before being credited elsewhere)) plus Eligible Accounts plus Eligible Inventory (not to exceed to the lesser of fifty percent (50%) of Eligible Accounts or Ten Million Dollars (\$10,000,000)) to (b) all Obligations owing from Borrower to Lenders (including the face amount of any issued but undrawn Letters of Credit, the aggregate amount outstanding on account of the Credit Card Services and any amounts outstanding under the Foreign Exchange Sublimit), measured monthly, of at least 1.50 to 1.00.

(b) Tangible Net Worth. Tangible Net Worth of at least Eight Million Dollars (\$8,000,000), increasing by (i) twenty five percent (25%) of New Equity, (ii) twenty five percent (25%) of the principal amount of the Investors' Indebtedness actually advanced to Borrower after the initial advance thereunder, (regardless of the amount of such initial advance thereunder), and (iii) and seventy percent (70%) of quarterly net profit after tax, if a positive number (determined in accordance with GAAP), not to exceed Ten Million Dollars (\$10,000,000) through December 31, 2011, measured quarterly.

6.9 Future Subsidiaries; Additional Collateral. With respect to each Person which becomes a Subsidiary of Borrower (directly or indirectly) subsequent to the Closing Date, Borrower shall cause such new Subsidiary to execute and deliver to the Collateral Agent, for and on behalf of each of the Lenders:

(a) within thirty (30) days after the date such Person becomes a Domestic Subsidiary, a Guaranty, or in the event that a Guaranty already exists, a joinder agreement to the Guaranty whereby such Domestic Subsidiary becomes obligated as a Guarantor under the Guaranty;

(b) within thirty (30) days after the date such Person becomes a Domestic Subsidiary, a joinder agreement to the Security Agreement whereby such Domestic Subsidiary grants a Lien over its assets as set forth in the Security Agreement, and such Domestic Subsidiary shall take such additional actions as may be necessary to ensure a valid first priority perfected Lien over such assets of such Domestic Subsidiary, subject only to the other Liens permitted pursuant to this Agreement and

(c) within thirty (30) days after the date such Person becomes a Subsidiary, a pledge agreement with respect to the Shares of such Subsidiary, and such other instruments as may reasonably be requested by Collateral Agent to perfect a security interest in the Shares of such Subsidiary, all in form and content reasonably acceptable to Collateral Agent, except to the extent (i) prohibited by applicable law, and (ii) prohibited by the documents governing such Shares.

6.10 Share Pledges. Borrower shall, within sixty (60) days of the Closing Date, cause to be delivered to Collateral Agent such documents and agreements as Collateral Agent reasonable deems necessary to perfect Collateral Agent's security interest in Shares of Borrower's Foreign Subsidiaries, except to the extent (i) prohibited by applicable law, and (ii) prohibited by the documents governing such Shares.

6.11 Further Assurances. At any time and from time to time Borrower shall execute and deliver such further instruments and take such further action as may reasonably be requested by any Lender to effect the purposes of this Agreement.

7. NEGATIVE COVENANTS.

Borrower will not do any of the following without Lenders' prior written consent, which shall not be unreasonably withheld:

7.1 Dispositions. Convey, sell, lease, transfer or otherwise dispose of (collectively, a "Transfer") or permit any of its Subsidiaries to Transfer, all or any part of its business or property, other than: (i) Transfers of Inventory in the ordinary course of business; (ii) Transfers of non-exclusive licenses and similar arrangements for the use of the property of Borrower or its Subsidiaries in the ordinary course of business and of licenses that could not result in a legal transfer of title of the licensed property but that may be exclusive in respects other than territory and that may be exclusive as to territory only as to discreet geographical areas outside of the United States; (iii) Transfers of surplus, worn-out or obsolete Equipment which was not financed by a Lender; (iv) Transfers in connection with Permitted Liens and Permitted Investments; (v) transfers from any Subsidiary to Borrower and from any Foreign Subsidiary to another Foreign Subsidiary; (vi) transfers permitted under Sections 7.3, 7.6, and 7.7; and (vii) Transfers that are not otherwise permitted under this Section 7.1 in an amount not to exceed Two Hundred Fifty Thousand Dollars (\$250,000) in the aggregate in any fiscal year.

7.2 Change in Business; Change in Control or Executive Office. Engage in any business, or permit any of its Subsidiaries to engage in any business, other than the businesses currently engaged in by

Borrower and any business substantially similar or related thereto (or incidental thereto); or cease to conduct business in the manner conducted by Borrower as of the Closing Date; or suffer or permit a Change in Control; or without thirty (30) days prior written notification to Lenders, relocate its chief executive office or state of incorporation or change its legal name; or without Required Lenders' prior written consent, change the date on which its fiscal year ends. Lender acknowledges receipt of notice that as of the date of this Agreement Borrower intends to relocate its principal place of business.

7.3 Mergers or Acquisitions. Merge or consolidate, or permit any of its Subsidiaries to merge or consolidate, with or into any other business organization, or acquire, or permit any of its Subsidiaries to acquire, all or substantially all of the capital stock or property of another Person, provided that a Subsidiary may merge or consolidate into another Subsidiary or into Borrower.

7.4 Indebtedness. Create, incur, assume or be or remain liable with respect to any Indebtedness, or permit any Subsidiary so to do, other than Permitted Indebtedness.

7.5 Encumbrances. Create, incur, assume or suffer to exist any Lien with respect to any of its property, including intellectual property, or assign or otherwise convey any right to receive income, including the sale of any Accounts, or permit any of its Subsidiaries so to do, except for Permitted Liens, or agree with any Person, other than Lenders and any holders of Permitted Indebtedness under clauses (b), (c), (d), (f) and (g) of such defined term, not to grant a security interest in, or otherwise encumber, any of its property, including intellectual property, or permit any Subsidiary to do so.

7.6 Distributions. Pay any dividends or make any other distribution or payment on account of or in redemption, retirement or purchase of any capital stock (or permit any of its Subsidiaries to do so), except that Borrower may (i) pay dividends in capital stock, (ii) repurchase the stock of employees, officers or directors pursuant to stock repurchase agreements or stock purchase plans as long as an Event of Default does not exist prior to such repurchase or would not exist after giving effect to such repurchase, (iii) repurchase the stock of employees, officers or directors pursuant to stock repurchase agreements or stock purchase plans by the cancellation of indebtedness owed by such employees to Borrower regardless of whether an Event of Default exists, (iv) convert any of its convertible securities (including warrants) into other securities pursuant to the terms of such convertible securities, and (v) distribute securities to employees, officers or directors on the exercise of their options.

7.7 Investments. Directly or indirectly acquire or own, or make any Investment in or to any Person, or permit any of its Subsidiaries so to do, other than Permitted Investments; or, subject to Section 6.7, maintain or invest any of its property with a Person other than a Lender or permit any of its Subsidiaries to do so unless such Person has entered into an account control agreement with Lenders in form and substance reasonably satisfactory to Required Lenders, or suffer or permit any Subsidiary to be a party to, or be bound by, an agreement that restricts such Subsidiary from paying dividends or otherwise distributing property to Borrower.

7.8 Transactions with Affiliates. Directly or indirectly enter into or permit to exist any material transaction with any Affiliate of Borrower except for (i) transactions that are in the ordinary course of Borrower's business, upon fair and reasonable terms that are no less favorable to Borrower than would be obtained in an arm's length transaction with a non-affiliated Person or are otherwise approved by the disinterested members of Borrower's board of directors, (ii) Borrower's sale of equity and debt securities (provided that such debt securities constitute Subordinated Debt) to venture capital or other strategic investors (including but not limited to the Investors' Indebtedness, provided the same is subject to the Investors Subordination Agreement prior to any credit extension thereunder), (iii) reasonable and customary fees paid to members of the Board of Directors of Borrower and its Subsidiaries, (iv) employment arrangements with executive officers entered into in the ordinary course of business, on fair and reasonable terms, as approved by Borrower's Board of Directors, or (v) any transaction between Borrower and its Subsidiaries or between Borrower's Subsidiaries constituting Permitted Investments and/or Permitted Indebtedness. Without limiting the foregoing, but subject to Collateral Agent's receipt of the Investors Subordination Agreement, Collateral Agent and Lenders hereby acknowledge and agree that Borrower may execute, deliver and perform the terms and conditions of the Investors' Note Purchase Agreement.

7.9 Subordinated Debt. Make any payment in respect of any Subordinated Debt, or permit any of its Subsidiaries to make any such payment, except in compliance with the terms of such Subordinated Debt or

any intercreditor or subordination agreement, or amend any provision contained in any documentation relating to the Subordinated Debt without Required Lenders' prior written consent.

7.10 Inventory and Equipment. Store the Inventory or the Equipment with an aggregate value in excess of Fifty Thousand Dollars (\$50,000) with a bailee, warehouseman, or other third party other than Flextronics (international or domestic locations) or any foreign locations located outside the United States and disclosed in the Disclosure Letter unless the third party has been notified of Lenders' security interest and Collateral Agent, for the ratable benefit of the Lenders (a) has received an acknowledgment from the third party that it is holding or will hold the Inventory or Equipment for Collateral Agent's benefit or (b) is in pledge possession of the warehouse receipt, where negotiable, covering such Inventory or Equipment; provided that, Borrower shall provide Lenders an Amended and Restated Bailee Acknowledgement, or similar, in form and content reasonably acceptable to Required Lenders, duly executed by Flextronics US, within sixty (60) days of the Closing Date (or such extension as agreed to by Required Lenders). Store or maintain any Equipment or Inventory with an aggregate value in excess of Fifty Thousand Dollars (\$50,000) at a location other than at Flextronics (international or domestic locations) or the location set forth in Section 10 of this Agreement or in the Disclosure Letter Notwithstanding the foregoing, Borrower may maintain (i) test equipment and (ii) up to Three Million Dollars (\$3,000,000) in raw materials in transit from Borrower's supplier(s) to Phoenix or Flextronics' manufacturing facilities (domestic or international) without complying with (a) or (b), above.

7.11 Compliance. Become an "investment company" or be controlled by an "investment company," within the meaning of the Investment Company Act of 1940, or become principally engaged in, or undertake as one of its important activities, the business of extending credit for the purpose of purchasing or carrying margin stock, or use the proceeds of any Credit Extension for such purpose. Fail to meet the minimum funding requirements of ERISA, permit a Reportable Event or Prohibited Transaction, as defined in ERISA, to occur, fail to comply with the Federal Fair Labor Standards Act or violate any law or regulation, which violation could have a Material Adverse Effect, or a material adverse effect on the Collateral or the priority of Lenders' Lien on the Collateral, or permit any of its Subsidiaries to do any of the foregoing.

8. EVENTS OF DEFAULT.

Any one or more of the following events shall constitute an Event Default by Borrower under this Agreement:

8.1 Payment Default. If Borrower fails to pay, when due, any of the Obligations;

8.2 Covenant Default.

(a) If Borrower fails to perform any obligation under Article 6 or violates any of the covenants contained in Article 7 of this Agreement; or

(b) If Borrower fails or neglects to perform or observe any other material term, provision, condition, covenant contained in this Agreement, in any of the Loan Documents, or in any other present or future agreement between Borrower and any Lender and as to any default under such other term, provision, condition or covenant that can be cured, has failed to cure such default within ten days after Borrower receives notice thereof or any officer of Borrower becomes aware thereof; provided, however, that if the default cannot by its nature be cured within the ten day period or cannot after diligent attempts by Borrower be cured within such ten day period, and such default is likely to be cured within a reasonable time, then Borrower shall have an additional reasonable period (which shall not in any case exceed 30 days) to attempt to cure such default, and within such reasonable time period the failure to have cured such default shall not be deemed an Event of Default but no Credit Extensions will be made.

8.3 Material Adverse Effect. If there occurs any circumstance or circumstances that could reasonably be expected to have a Material Adverse Effect, as determined by the Required Lenders;

8.4 Attachment. If any material portion of Borrower's assets is attached, seized, subjected to a writ or distress warrant, or is levied upon, or comes into the possession of any trustee, receiver or person acting in a similar capacity and such attachment, seizure, writ or distress warrant or levy has not been removed, discharged or rescinded within ten (10) days, or if Borrower is enjoined, restrained, or in any way prevented by court order from continuing to conduct all or any material part of its business affairs, or if a judgment or other claim becomes a lien or encumbrance upon any material portion of Borrower's assets, or if a notice of lien, levy, or assessment is filed of record with respect to any of Borrower's assets by the United States Government, or any department, agency, or instrumentality thereof, or by any state, county, municipal, or governmental agency, and the same is not paid within ten (10) days after Borrower receives notice thereof, provided that none of the foregoing shall constitute an Event of Default where such action or event is stayed or an adequate bond has been posted pending a good faith contest by Borrower (provided that no Credit Extensions will be required to be made during such cure period);

8.5 Insolvency. If Borrower is unable to pay its debts (including trade debts) as they become due, or if an Insolvency Proceeding is commenced by Borrower, or if an Insolvency Proceeding is commenced against Borrower and is not dismissed or stayed within forty five (45) days (provided that no Credit Extensions will be made prior to the dismissal of such Insolvency Proceeding);

8.6 Other Agreements. If there is a default or other failure to perform in any agreement to which Borrower is a party or by which it is bound resulting in a right by a third party or parties, whether or not exercised, to accelerate the maturity of any Indebtedness in an amount in excess of Five Hundred Thousand Dollars (\$500,000) or which could have a Material Adverse Effect; provided, however, that the Event of Default under this Section 8.6 caused by the occurrence of a default under such other agreement shall be cured or waived for purposes of this Agreement upon Lenders receiving written notice from the party asserting such default of such cure or waiver of the default under such other agreement, if at the time of such cure or waiver under such other agreement (x) Lenders have not declared an Event of Default under this Agreement and/or exercised any rights with respect thereto; (y) any such cure or waiver does not result in an Event of Default under any other provision of this Agreement or any Loan Document; and (z) in connection with any such cure or waiver under such other agreement, the terms of any agreement with such third party are not modified or amended in any manner which could in the good faith judgment of a Lender be materially less advantageous in Borrower or any Subsidiary.

8.7 Judgments. If a judgment or judgments for the payment of money in an amount, individually or in the aggregate, of at least Five Hundred Thousand Dollars (\$500,000) (not covered by insurance) shall be rendered against Borrower and shall remain unsatisfied and unstayed for a period of ten (10) days (provided that no Credit Extensions will be made prior to the satisfaction or stay of such judgment); or

8.8 Misrepresentations. If any material misrepresentation or material misstatement exists now or hereafter in any warranty or representation set forth herein or in any certificate delivered to any Lender by any Responsible Officer pursuant to this Agreement or to induce any Lender to enter into this Agreement or any other Loan Document.

9. RIGHTS AND REMEDIES.

9.1 Rights and Remedies.

(a) Upon the occurrence and during the continuance of an Event of Default, Collateral Agent may, and at the written direction of the Required Lenders shall, without notice or demand, do any or all of the following: (i) deliver notice of the Event of Default to Borrower, (ii) by notice to Borrower declare all Obligations immediately due and payable (but if an Event of Default described in Section 8.5 occurs, all Obligations shall be immediately due and payable without any action by Collateral Agent or the Lenders) or (iii) by notice to Borrower suspend or terminate the obligations, if any, of the Lenders to make Credit Extensions for Borrower's benefit under this Agreement or under any other agreement between Borrower and Collateral Agent and/or the Lenders (but if an Event of Default described in Section 8.5 occurs all obligations, if any, of the Lenders to make Credit Extensions for Borrower's benefit under this Agreement or under any other agreement between Borrower and Collateral Agent and/or the Lenders shall be immediately terminated without any action by Collateral Agent or the Lenders)

(b) Without limiting the rights of the Collateral Agent and the Lenders set forth in Section 9.1(a) above, upon the occurrence and during the continuance of an Event of Default, Collateral Agent shall have the right, at the written direction of the Required Lenders, without notice or demand, to do any or all of the following:

(i) foreclose upon and/or sell or otherwise liquidate, the Collateral, and credit bid and purchase at any public sale;

(ii) apply to the Obligations any (a) balances and deposits of Borrower that Collateral Agent or any Lender holds or controls, or (b) any amount held or controlled by Collateral Agent or any Lender owing to or for the credit or the account of Borrower; (provided that each Lender shall retain its setoff rights and its right to place a “hold” on any accounts maintained with it, exercisable without the approval of the other Lenders); and/or

(iii) commence and prosecute an Insolvency Proceeding or consent to Borrower commencing any Insolvency Proceeding.

(c) Without limiting the rights of the Collateral Agent and the Lenders set forth in Sections 9.1(a) and (b) above, upon the occurrence and during the continuance of an Event of Default, Collateral Agent shall have the right, without notice or demand, to do any or all of the following:

(i) settle or adjust disputes and claims directly with Account Debtors for amounts on terms and in any order that Collateral Agent and the Required Lenders consider advisable, notify any Person owing Borrower money of Collateral Agent’s and Lenders’ security interest in such funds, and verify the amount of such account;

(ii) make any payments and do any acts it considers necessary or reasonable to protect the Collateral and/or its security interest in the Collateral. Borrower shall assemble the Collateral if Collateral Agent requests and make it available in a location as Collateral Agent reasonably designates. Collateral Agent may enter premises where the Collateral is located, take and maintain possession of any part of the Collateral, and pay, purchase, contest or compromise any Lien which appears to be prior or superior to its security interest and pay all expenses incurred. Borrower grants Collateral Agent a license to enter and occupy any of its premises, without charge, to exercise any of Collateral Agent’s rights or remedies;

(iii) ship, reclaim, recover, store, finish, maintain, repair, prepare for sale, and/or advertise for sale, the Collateral. Upon the occurrence and during the continuance of an Event of Default, Collateral Agent and Lenders are hereby granted a non-exclusive, royalty-free license or other right to use, without charge, Borrower’s labels, patents, copyrights, mask works, rights of use of any name, trade secrets, trade names, trademarks, service marks, and advertising matter, or any similar property as it pertains to the Collateral, in completing production of advertising for sale, and selling any Collateral and, in connection with Collateral Agent’s or Lenders’ exercise of their rights under this Section 9.1, Borrower’s rights under all licenses and all franchise agreements inure to Collateral Agent for the benefit of the Lenders;

(iv) place a “hold” on any account maintained with Collateral Agent or deliver a notice of exclusive control, any entitlement order, or other directions or instructions pursuant to any Control Agreement or, similar agreements providing control of any Collateral;

(v) demand and receive possession of Borrower’s Books;

(vi) appoint a receiver to manage and realize upon any of the Collateral, and such receiver shall have any right and authority as any competent court will grant or authorize in accordance with any applicable law, including any power or authority to manage the business of Borrower; and

(vii) Subject to clauses 9.1(a) and 9.1(b), exercise all rights and remedies available to Collateral Agent and Lenders under the Loan Documents or at law or equity, including all remedies

provided under the Code (including disposal of the Collateral pursuant to the terms thereof), and including the power of attorney in Section 9.2.

Notwithstanding any provision of this Section 9.1 to the contrary, but subject to the next succeeding paragraph, upon the occurrence of any Event of Default, Collateral Agent and each Required Lender shall have the right to exercise any and all remedies referenced in this Section 9.1 following the occurrence of an Exigent Circumstance. As used in the immediately preceding sentence, "Exigent Circumstance" means any event or circumstance that, in the reasonable judgment of Collateral Agent or any Required Lender, imminently threaten the ability of Collateral Agent or any Required Lender to realize upon all or any material portion of the Collateral, such as, without limitation, fraudulent removal, concealment, or abscondment thereof, destruction or material waste thereof, or failure of Borrower after reasonable demand to maintain or reinstate adequate casualty insurance coverage, or which, in the reasonable judgment of Collateral Agent or any Required Lender, could reasonably be expected to result in a material diminution in value of the Collateral.

In the event of an Exigent Circumstance, the Required Lenders shall attempt to mutually agree as to what enforcement action (as described in this Section 9.1; each, an "Enforcement Action") to take; provided, however, that if after consultation, the Required Lenders cannot mutually agree on what action to take, then the Required Lender wishing to take the stronger Enforcement Action (the "Enforcing Lender") shall have the right to determine and shall control the timing, order and type of Enforcement Actions which will be taken and all other matters in connection with any such Enforcement Actions, upon any Required Lender becoming the Enforcing Lender, if the Enforcing Lender is not already the Collateral Agent, then automatically and without the necessity of any further action being taken by any party, (x) the original Collateral Agent shall be deemed to have resigned as Collateral Agent and (y) the Lenders shall be deemed to have unanimously appointed the Enforcing Lender as successor Collateral Agent under this Agreement and the Loan Documents (and the Enforcing Lender shall be deemed to have accepted such appointment) in accordance with 13.9 of this Agreement. In taking such Enforcement Actions pursuant to the previous sentence, the Enforcing Lender as such successor agent shall act in accordance with, and subject to the terms, conditions, rights and duties of Article 13 of this Agreement.

9.2 Power of Attorney. Borrower hereby irrevocably appoints Collateral Agent as its lawful attorney-in-fact, exercisable upon the occurrence and during the continuance of an Event of Default, to: (a) endorse Borrower's name on any checks of other forms of payment or security; (b) sign Borrower's name on any invoice or bill of lading for any Account or drafts against Account Debtors, (c) settle and adjust disputes and claims about the Accounts directly with Account Debtors, for amounts and on terms Collateral Agent determines reasonable; (d) make, settle, and adjust all claims under Borrower's insurance policies; (e) pay, contest or settle any Lien, charge, encumbrance, security interest, and adverse claim in or to the Collateral, or any judgment based thereon, or otherwise take any action to terminate or discharge the same; and (f) transfer the Collateral into the name of Collateral Agent or a third party as the Code or any applicable law permits. Borrower hereby appoints Collateral Agent as its lawful attorney-in-fact to sign Borrower's name on any documents necessary to perfect or continue the perfection of Collateral Agent's and Lenders' security interest in the Collateral regardless of whether an Event of Default has occurred until all Obligations have been satisfied in full and Collateral Agent and the Lenders are under no further obligation to make Credit Extensions hereunder. Collateral Agent's foregoing appointment as Borrower's attorney in fact, and all of Collateral Agent's rights and powers, coupled with an interest, are irrevocable until all Obligations (other than inchoate indemnity obligations) have been fully repaid and performed and Collateral Agent's and the Lenders' obligation to provide Credit Extensions terminates.

9.3 Protective Payments. If Borrower fails to obtain the insurance called for by Section 6.6 or fails to pay any premium thereon or fails to pay any other amount which Borrower is obligated to pay under this Agreement or any other Loan Document, Collateral Agent and any Lender (but without duplication with each other) may obtain such insurance or make such payment, and all amounts so paid by Collateral Agent or any Lender are Lenders' Expenses and immediately due and payable, bearing interest at the Default Rate, and secured by the Collateral. Collateral Agent will make reasonable efforts to provide Borrower with notice of Collateral Agent or any Lender obtaining such insurance or making such payment at the time it is obtained or paid or within a reasonable time thereafter. No such payments by Collateral Agent or any Lender are deemed an agreement to make similar payments in the future or Collateral Agent's or any Lenders' waiver of any Event of Default.

9.4 Application of Payments and Proceeds. Notwithstanding anything to the contrary contained in this Agreement, upon the occurrence and during the continuance of an Event of Default, (a) Borrower irrevocably waives the right to direct the application of any and all payments at any time or times thereafter received by Collateral Agent or any Lender from or on behalf of Borrower of all or any part of the Obligations, and, as between Borrower on the one hand and Collateral Agent and Lenders on the other, Collateral Agent and Lenders shall have the continuing and exclusive right to apply and to reapply any and all payments received against the Obligations in such manner as Collateral Agent and/or Lenders may deem advisable (subject to the pro rata application of all such sums in accordance with this Agreement and to the order of application set forth in clause (b) of this Section 9.4) notwithstanding any previous application by Collateral Agent or any Lender, and (b) the proceeds of any sale of, or other realization upon all or any part of the Collateral shall be applied: first, to the Lenders' Expenses; second, to accrued and unpaid interest on the Obligations (including any interest which but for the provisions of the United States Bankruptcy Code, would have accrued on such amounts); third to the principal amount of the Obligations outstanding (subject in the case of Credit Card Exposure and FX Contracts to the applicable amount of the Credit Card Reserve or the FX Reserve, as the case may be); and fourth, to any other indebtedness or obligations of Borrower owing to Collateral Agent or any Lender under the Loan Documents. Any balance remaining shall be delivered to Borrower or to whomever may be lawfully entitled to receive such balance or as a court of competent jurisdiction may direct. In carrying out the foregoing, (x) amounts received shall be applied in the numerical order provided until exhausted prior to the application to the next succeeding category, and (y) each of the Persons entitled to receive a payment in any particular category shall receive an amount equal to its Pro Rata Share of amounts available to be applied pursuant thereto for such category. Any reference in this Agreement to an allocation between or sharing by the Lenders of any right, interest or obligation "ratably," "proportionally" or in similar terms shall refer to Pro Rata Share unless expressly provided otherwise. Collateral Agent, or if applicable, each Lender, shall promptly remit to the other Lenders such sums as may be necessary to ensure the ratable repayment of each Lender's portion of the Advances and the ratable distribution of interest, fees and reimbursements paid or made by Borrower. Notwithstanding the foregoing, a Lender receiving a scheduled payment shall not be responsible for determining whether the other Lenders also received their scheduled payment on such date; provided, however, if it is later determined that a Lender received more than its Pro Rata Share of scheduled payments made on any date or dates, then such Lender shall remit to Collateral Agent or other Lenders such sums as may be necessary to ensure the ratable payment of such scheduled payments, as instructed by Collateral Agent. Any payment or distribution of any kind or character, whether in cash, properties or securities, shall be received by a Lender in excess of its ratable share then the portion of such payment or distribution in excess of such Lender's Pro Rata Share shall be received by such Lender in trust for and shall be promptly paid over to the other Lender for application to the payments of amounts due on the other Lenders' claims. To the extent any payment for the account of Borrower is required to be returned as a voidable transfer or otherwise, the Lenders shall contribute to one another as is necessary to ensure that such return of payment is on a pro rata basis. If any Lender shall obtain possession of any Collateral, it shall hold such Collateral for itself and as agent and bailee for Collateral Agent and Lenders for purposes of perfecting Collateral Agent's and Lenders' security interest therein. Notwithstanding anything to the contrary contained herein, Borrower shall not be liable for the failure of any Lender to comply with its obligations hereunder.

9.5 Liability for Collateral. So long as Collateral Agent and the Lenders comply with reasonable banking practices regarding the safekeeping of the Collateral in the possession or under the control of Collateral Agent and the Lenders, Collateral Agent and the Lenders shall not be liable or responsible for: (a) the safekeeping of the Collateral; (b) any loss or damage to the Collateral; (c) any diminution in the value of the Collateral; or (d) any act or default of any carrier, warehouseman, bailee, or other Person. Borrower bears all risk of loss, damage or destruction of the Collateral.

9.6 Remedies Cumulative. Collateral Agent's or any Lenders' failure, at any time or times, to require strict performance by Borrower of any provision of this Agreement or any other Loan Document shall not waive, affect, or diminish any right of Collateral Agent or any Lender thereafter to demand strict performance and compliance herewith or therewith. Collateral Agent's and Lenders' rights and remedies under this Agreement and the other Loan Documents are cumulative. Collateral Agent and Lenders have all rights and remedies provided under the Code, any applicable law, by law, or in equity. Collateral Agent's or any Lenders' exercise of one right or remedy is not an election, and Collateral Agent's or any Lenders' waiver of any Event of Default is not a continuing waiver. Collateral Agent's or any Lender's delay in exercising any remedy is not a waiver, election, or acquiescence.

9.7 Demand; Protest. Borrower waives demand, protest, notice of protest, notice of default or dishonor, notice of payment and nonpayment, notice of any default, nonpayment at maturity, release, compromise, settlement, extension, or renewal of accounts, documents, instruments, chattel paper and guarantees at any time held by Collateral Agent or any Lender on which Borrower may in any way be liable.

10. NOTICES.

Unless otherwise provided in this Agreement, all notices or demands by any party relating to this Agreement or any other agreement entered into in connection herewith shall be in writing and (except for financial statements and other informational documents which may be sent by first-class mail, postage prepaid) shall be personally delivered or sent by a recognized overnight delivery service, certified mail, postage prepaid, return receipt requested, or by telefacsimile to Borrower or to Lenders, as the case may be, at its addresses set forth below:

If to Borrower: Enphase Energy, Inc.
201 First Street, Suite 300
Petaluma, CA 94952
Attn: Chief Financial Officer

If to Collateral Agent
or Bridge Bank: Bridge Bank, National Association
55 Almaden Boulevard
San Jose, California 95113
Attn: Mike Field, Executive Vice President

If to Comerica Bank: Comerica Bank
M/C 7578
39200 Six Mile Rd
Livonia, MI 48152
Attn: National Documentation Services

With a copy to: Comerica Bank
M/C 4120
226 Airport Parkway, Suite 100
San Jose, CA 95110
Attn: Guy Simpson, Vice President

The parties hereto may change the address at which they are to receive notices hereunder, by notice in writing in the foregoing manner given to the other.

11. CHOICE OF LAW AND VENUE; JURY TRIAL WAIVER.

This Agreement shall be governed by, and construed in accordance with, the internal laws of the State of California, without regard to principles of conflicts of law. Each of Borrower and Lenders hereby submits to the exclusive jurisdiction of the state and Federal courts located in the County of Santa Clara, State of California. BORROWER AND LENDERS EACH HEREBY WAIVE THEIR RESPECTIVE RIGHTS TO A JURY TRIAL OF ANY CLAIM OR CAUSE OF ACTION BASED UPON OR ARISING OUT OF ANY OF THE LOAN DOCUMENTS OR ANY OF THE TRANSACTIONS CONTEMPLATED THEREIN, INCLUDING CONTRACT CLAIMS, TORT CLAIMS, BREACH OF DUTY CLAIMS, AND ALL OTHER COMMON LAW OR STATUTORY CLAIMS. EACH PARTY RECOGNIZES AND AGREES THAT THE FOREGOING WAIVER CONSTITUTES A MATERIAL INDUCEMENT FOR IT TO ENTER INTO THIS AGREEMENT. EACH PARTY REPRESENTS AND WARRANTS THAT IT HAS REVIEWED THIS WAIVER WITH ITS LEGAL

COUNSEL AND THAT IT KNOWINGLY AND VOLUNTARILY WAIVES ITS JURY TRIAL RIGHTS FOLLOWING CONSULTATION WITH LEGAL COUNSEL.

If the jury waiver set forth in Section 11 is not enforceable, then any dispute, controversy or claim arising out of or relating to this Agreement, the Loan Documents or any of the transactions contemplated therein shall be settled by judicial reference pursuant to Code of Civil Procedure Section 638 et seq. before a referee sitting without a jury, such referee to be mutually acceptable to the parties or, if no agreement is reached, by a referee appointed by the Presiding Judge of the California Superior Court for Santa Clara County. This Section shall not restrict a party from exercising remedies under the Code or from exercising pre-judgment remedies under applicable law.

12. GENERAL PROVISIONS.

12.1 Successor and Assigns. This Agreement shall bind and inure to the benefit of the respective successors and permitted assigns of each of the parties; provided, however, that neither this Agreement nor any rights hereunder may be assigned by Borrower without Required Lenders' prior written consent, which consent may be granted or withheld in Required Lenders' sole discretion. Lenders shall have the right without the consent of or notice to Borrower to sell, transfer, negotiate, or grant participation in all or any part of, or any interest in, Lenders' obligations, rights and benefits hereunder.

12.2 Indemnification. Borrower shall defend, indemnify and hold harmless Lenders and its officers, employees, and agents against: (a) all obligations, demands, claims, and liabilities claimed or asserted by any other party in connection with the transactions contemplated by this Agreement; and (b) all losses or Lender Expenses in any way suffered, incurred, or paid by a Lender as a result of or in any way arising out of, following, or consequential to transactions between a Lender and Borrower whether under this Agreement, or otherwise (including without limitation reasonable attorneys' fees and expenses), except for losses caused by Lenders' gross negligence or willful misconduct.

12.3 Time of Essence. Time is of the essence for the performance of all obligations set forth in this Agreement.

12.4 Severability of Provisions. Each provision of this Agreement shall be severable from every other provision of this Agreement for the purpose of determining the legal enforceability of any specific provision.

12.5 Amendments in Writing; Integration. (a) No amendment, modification, termination or waiver of any provision of this Agreement or any other Loan Document, no approval or consent thereunder, or any consent to any departure by Borrower therefrom, shall in any event be effective unless the same shall be in writing and signed by Borrower, Collateral Agent and the Required Lenders provided that:

(i) (x) no such amendment, waiver or other modification that would have the effect of increasing or reducing a Lender's Commitment Amount or Commitment Percentage shall be effective as to such Lender without such Lender's written consent and (y) no such amendment, waiver or other modification that would have the effect of increasing the aggregate Commitment Amount shall be effective without all Lenders' consent;

(ii) no such amendment, waiver or modification that would affect the rights and duties of Collateral Agent shall be effective without Collateral Agent's written consent or signature;

(iii) no such amendment, waiver or other modification shall, unless signed by all the Lenders directly affected thereby, (A) reduce the principal of, rate of interest on or any fees with respect to the Revolving Line, any Letter of Credit, Credit Card Exposure or FX Contract or forgive any principal, interest (other than default interest) or fees (other than late charges) with respect to the Revolving Line, any Letter of Credit, Credit Card Exposure or FX Contract (B) postpone the date fixed for, or waive, any payment of principal of or interest on the Revolving Line or any Letter of Credit, Credit Card Exposure or FX Contract (other than default interest) or any fees provided for hereunder (other than late charges or for any termination of any commitment); (C)

change the definition of the term "Required Lenders" or the percentage of Lenders which shall be required for Lenders to take any action hereunder or change any provision hereunder requiring the consent, approval or action of all Lenders; (D) release all or substantially all or any material portion of the Collateral, authorize Borrower to sell or otherwise dispose of all or substantially all or any material portion of the Collateral or release any guarantor of all or any portion of the Obligations or its guaranty obligations with respect thereto, except, in each case with respect to this clause (D), as otherwise may be expressly permitted under this Agreement or the other Loan Documents (including in connection with any disposition permitted hereunder); (E) amend, waive or otherwise modify this Section 12.5 or the definitions of the terms used in this Section 12.5 insofar as the definitions affect the substance of this Section 12.5; (F) consent to the assignment, delegation or other transfer by Borrower of any of its rights and obligations under any Loan Document or release Borrower of its payment obligations under any Loan Document, except, in each case with respect to this clause (F), pursuant to a merger or consolidation permitted pursuant to this Agreement; (G) amend any of the provisions of Section 9.4 or amend any of the definitions Pro Rata Share, Commitment Amount, Commitment Percentage or that provide for the Lenders to receive then Pro Rata Shares of any fees, payments, setoffs or proceeds of Collateral hereunder; or (H) subordinate the Liens granted in favor of Collateral Agent or any Lender securing the Obligations, except with respect to Liens expressly permitted to be senior to the Collateral Agent's Liens hereunder. It is hereby understood and agreed that all Lenders shall be deemed directly affected by an amendment, waiver or other modification of the type described in the preceding clauses (C), (D), (E), (F), (G) and (H) of the preceding sentence; and

(iv) the provisions of the foregoing clauses (i), (ii) and (iii) are subject to the provisions of any interlender or agency agreement among the Lenders and Collateral Agent pursuant to which any Lender may agree to give its consent in connection with any amendment, waiver or modification of the Loan Documents only in the event of the unanimous agreement of all Lenders.

(b) Other than as expressly provided for in Section 12.5(a)(i)-(iii), Collateral Agent may, if requested by the Required Lenders, from time to time designate covenants in this Agreement less restrictive by notification to a representative of Borrower.

(c) This Agreement and the Loan Documents represent the entire agreement about this subject matter and supersede prior negotiations or agreements. All prior agreements, understandings, representations, warranties, and negotiations between the parties about the subject matter of this Agreement and the Loan Documents merge into this Agreement and the Loan Documents.

12.6 Counterparts. This Agreement may be executed in any number of counterparts and by different parties on separate counterparts, each of which, when executed and delivered, shall be deemed to be an original, and all of which, when taken together, shall constitute but one and the same Agreement.

12.7 Survival. All covenants, representations and warranties made in this Agreement shall continue in full force and effect so long as any Obligations remain outstanding or any Lender has any obligation to make Credit Extensions to Borrower. The obligations of Borrower to indemnify Lenders with respect to the expenses, damages, losses, costs and liabilities described in Section 12.2 shall survive until all applicable statute of limitations periods with respect to actions that may be brought against Lenders have run.

12.8 Confidentiality. In handling any confidential information Lenders and all employees and agents of Lenders, including but not limited to accountants, shall exercise the same degree of care that it exercises with respect to its own proprietary information of the same types to maintain the confidentiality of any non-public information thereby received or received pursuant to this Agreement except that disclosure of such information may be made (i) to the subsidiaries or affiliates of Lenders in connection with their present or prospective business relations with Borrower, (ii) to prospective transferees or purchasers of any interest in the Loans, provided that they have entered into a comparable confidentiality agreement in favor of Borrower and have delivered a copy to Borrower, (iii) as required by law, regulations, rule or order, subpoena, judicial order or similar order, (iv) as may be required in connection with the examination, audit or similar investigation of a Lender and (v) as a Lender may determine in connection with the enforcement of any remedies hereunder. Confidential information hereunder shall not include information that either: (a) is in the public domain or in the knowledge or possession of a Lender when disclosed to such Lender, or becomes part of the public domain after disclosure to a

Lender through no fault of any Lender; or (b) is disclosed to a Lender by a third party, provided such Lender does not have actual knowledge that such third party is prohibited from disclosing such information.

12.9 Patriot Act. To help the government fight the funding of terrorism and money laundering activities, Federal law requires all financial institutions to obtain, verify, and record information that identifies each person who opens an account. WHAT THIS MEANS FOR YOU: when you open an account, we will ask your name, address, date of birth, and other information that will allow us to identify you. We may also ask to see your driver's license or other identifying documents.

12.10 Effect of Amendment and Restatement. Except as otherwise set forth herein, this Agreement is intended to and does completely amend and restate, without novation, the Original Agreement. All security interests granted under the Original Agreement are hereby confirmed and ratified and shall continue to secure all Obligations under this Agreement.

13. COLLATERAL AGENT.

13.1 Appointment and Authorization of Collateral Agent. Each Lender hereby irrevocably appoints, designates and authorizes Collateral Agent to take such action on its behalf under the provisions of this Agreement and each other Loan Document and to exercise such powers and perform such duties as are expressly delegated to it by the terms of this Agreement or any other Loan Document, together with such powers as are reasonably incidental thereto. Notwithstanding any provision to the contrary contained elsewhere herein or in any other Loan Document, Collateral Agent shall not have any duties or responsibilities, except those expressly set forth herein, nor shall Collateral Agent have or be deemed to have any fiduciary relationship with any Lender or participant, and no implied covenants, functions, responsibilities, duties, obligations or liabilities shall be read into this Agreement or any other Loan Document or otherwise exist against Collateral Agent. Without limiting the generality of the foregoing sentence, the use of the term "agent" herein and in the other Loan Documents with reference to Collateral Agent is not intended to connote any fiduciary or other implied (or express) obligations arising under agency doctrine of any applicable law. Instead, such term is used merely as a matter of market custom, and is intended to create or reflect only an administrative relationship between independent contracting parties.

13.2 Delegation of Duties. Collateral Agent may execute any of its duties under this Agreement or any other Loan Document by or through its, or its Affiliates', agents, employees or attorneys-in-fact and shall be entitled to obtain and rely upon the advice of counsel and other consultants or experts concerning all matters pertaining to such duties. Collateral Agent shall not be responsible for the negligence or misconduct of any agent or attorney-in-fact that it selects in the absence of gross negligence or willful misconduct.

13.3 Liability of Collateral Agent. Except as otherwise provided herein, no Collateral Agent-Related Person shall (a) be liable for any action taken or omitted to be taken by any of them under or in connection with this Agreement or any other Loan Document or the transactions contemplated hereby (except for its own gross negligence or willful misconduct in connection with its duties expressly set forth herein), or (b) be responsible in any manner to any Lender or participant for any recital, statement, representation or warranty made by Borrower or any officer thereof, contained herein or in any other Loan Document, or in any certificate, report, statement or other document referred to or provided for in, or received by Collateral Agent under or in connection with, this Agreement or any other Loan Document, or the validity, effectiveness, genuineness, enforceability or sufficiency of this Agreement or any other Loan Document, or for any failure of Borrower or any other party to any Loan Document to perform its obligations hereunder or thereunder. No Collateral Agent-Related Person shall be under any obligation to any Lender or participant to ascertain or to inquire as to the observance or performance of any of the agreements contained in, or conditions of, this Agreement or any other Loan Document, or to inspect the properties, books or records of Borrower or any Affiliate thereof.

13.4 Reliance by Collateral Agent. Collateral Agent shall be entitled to rely, and shall be fully protected in relying, upon any writing, communication, signature, resolution, representation, notice, consent, certificate, affidavit, letter, telegram, facsimile, telex or telephone message, electronic mail message, statement or other document or conversation reasonably believed by it to be genuine and correct and to have been signed, sent or made by the proper Person or Persons, and upon advice and statements of legal counsel (including counsel to Borrower), independent accountants and other experts selected by Collateral Agent. As between Collateral Agent

and Lenders. Collateral Agent shall be fully justified in failing or refusing to take any action under any Loan Document unless it shall first receive such advice or concurrence of all Lenders as it deems appropriate and if it so requests, it shall first be indemnified to its satisfaction by the Lenders against any and all liability and expense which may be incurred by it by reason of taking or continuing to take any such action. Collateral Agent shall in all cases be fully protected in acting, or in refraining from acting, under this Agreement or any other Loan Document in accordance with a request or consent of all Lenders and such request and any action taken or failure to act pursuant thereto shall be binding upon all the Lenders.

13.5 Notice of Default. Collateral Agent shall not be deemed to have knowledge or notice of the occurrence of any default and/or Event of Default, unless Collateral Agent shall have received written notice from a Lender or Borrower, describing such default or Event of Default. Collateral Agent will notify the Lenders of its receipt of any such notice. Collateral Agent shall take such action permitted by this Agreement with respect to an Event of Default as may be directed in writing by the Required Lenders in accordance with Article 9(a); provided, however, that while an Event of Default has occurred and is continuing, Collateral Agent may (but shall not be obligated to) take such action, or refrain from taking such action, with respect to such Event of Default as Collateral Agent shall deem advisable or in the best interest of the Lenders, including without limitation, satisfaction of other security interests, liens or encumbrances on the Collateral not permitted under the Loan Documents, payment of taxes on behalf of Borrower, payments to landlords, warehouseman, bailees and other persons in possession of the Collateral and other actions to protect and safeguard the Collateral, and actions with respect to insurance claims for casualty events affecting Borrower and/or the Collateral.

13.6 Credit Decision; Disclosure of Information by Collateral Agent. Each Lender acknowledges that no Collateral Agent-Related Person has made any representation or warranty to it, and that no act by Collateral Agent hereafter taken, including any consent to and acceptance of any assignment or review of the affairs of Borrower or any Affiliate thereof, shall be deemed to constitute any representation or warranty by any Collateral Agent-Related Person to any Lender as to any matter, including whether Collateral Agent-Related Persons have disclosed material information in their possession. Each Lender represents to Collateral Agent that it has, independently and without reliance upon any Collateral Agent-Related Person and based on such documents and information as it has deemed appropriate, made its own appraisal of, and investigation into, the business, prospects, operations, property, financial and other condition and creditworthiness of Borrower and its Subsidiaries, and all applicable bank or other regulatory laws relating to the transactions contemplated hereby, and made its own decision to enter into this Agreement and to extend credit to Borrower hereunder. Each Lender also represents that it will, independently and without reliance upon any Collateral Agent-Related Person and based on such documents and information as it shall deem appropriate at the time, continue to make its own credit analysis, appraisals and decisions in taking or not taking action under this Agreement and the other Loan Documents, and to make such investigations as it deems necessary to inform itself as to the business, prospects, operations, property, financial and other condition and creditworthiness of Borrower. Except for notices, reports and other documents expressly required to be furnished to the Lenders by Collateral Agent herein, Collateral Agent shall not have any duty or responsibility to provide any Lender with any credit or other information concerning the business, prospects, operations, property, financial and other condition or creditworthiness of Borrower or any of its Affiliates which may come into the possession of any Collateral Agent-Related Person.

13.7 Indemnification of Collateral Agent. Whether or not the transactions contemplated hereby are consummated, each Lender shall, severally and pro rata based on its respective Pro Rata Share, indemnify upon demand each Collateral Agent-Related Person (to the extent not reimbursed by or on behalf of Borrower and without limiting the obligation of Borrower to do so), and hold harmless each Collateral Agent-Related Person from and against any and all claims, damages, losses, liabilities, costs or expenses (which shall not include legal expenses of Collateral Agent incurred in connection with the closing of the transactions contemplated by this Agreement) incurred by it; provided, however, that no Lender shall be liable for the payment to any Collateral Agent-Related Person of any portion of such Indemnified Liabilities to the extent determined in a judgment by a court of competent jurisdiction to have resulted from such Collateral Agent-Related Person's own gross negligence or willful misconduct; provided, however, that no action taken in accordance with the directions of the Required Lenders shall be deemed to constitute gross negligence or willful misconduct for purposes of this Section 13.7. Without limitation of the foregoing, each Lender shall, severally and pro rata based on its respective Pro Rata Share, reimburse Collateral Agent upon demand for its ratable share of any costs or out-of-pocket expenses (including Lenders' Expenses incurred after the closing of the transactions contemplated by this Agreement)

incurred by Collateral Agent (in its capacity as Collateral Agent, and not as a Lender) in connection with the preparation, execution, delivery, administration, modification, amendment or enforcement (whether through negotiations, legal proceedings or otherwise) of, or legal advice in respect of rights or responsibilities under, this Agreement, any other Loan Document, or any document contemplated by or referred to herein, to the extent that Collateral Agent is not reimbursed for such expenses by or on behalf of Borrower. The undertaking in this Section 13.7 shall survive the payment in full of the Obligations, the termination of this Agreement and the resignation of Collateral Agent.

13.8 Collateral Agent in its Individual Capacity. With respect to its Credit Extensions, Bridge shall have the same rights and powers under this Agreement as any other Lender and may exercise such rights and powers as though it were not Collateral Agent, and the terms “Lender” and “Lenders” include Bridge in its individual capacity.

13.9 Successor Collateral Agent. Collateral Agent may resign as Collateral Agent upon ten (10) days’ notice to the Lenders and Borrower. If Collateral Agent resigns under this Agreement, all Lenders shall appoint from among the Lenders (or the affiliates thereof) a successor Collateral Agent for the Lenders, which successor Collateral Agent shall (unless an Event of Default has occurred and is continuing) be subject to the approval of Borrower (which approval shall not be unreasonably withheld or delayed). If no successor Collateral Agent is appointed prior to the effective date of the resignation of Collateral Agent, Collateral Agent may appoint, after consulting with the Lenders and upon notice to Borrower, a successor Collateral Agent from among the Lenders (or the affiliates thereof). Upon the acceptance of its appointment as successor Collateral Agent hereunder, the Person acting as such successor Collateral Agent shall succeed to all the rights, powers and duties of the retiring Collateral Agent and the respective term “Collateral Agent” means such successor Collateral Agent and the retiring Collateral Agent’s appointment, powers and duties in such capacities shall be terminated without any other further act or deed on its behalf. After any retiring Collateral Agent’s resignation hereunder as Collateral Agent, the provisions of this Article 13 and Section 12.1 shall inure to its benefit as to any actions taken or omitted to be taken by it while it was Collateral Agent under this Agreement. If no successor Collateral Agent has accepted appointment as Collateral Agent by the date ten (10) days following a retiring Collateral Agent’s notice of resignation, the retiring Collateral Agent’s resignation shall nevertheless thereupon become effective and the Lenders shall perform all of the duties of Collateral Agent hereunder until such time, if any, as the Lenders appoint a successor agent as provided for above.

13.10 Collateral Agent May File Proofs of Claim. In case of the pendency of any receivership, insolvency, liquidation, bankruptcy, reorganization, arrangement, adjustment, composition or other judicial proceeding relative to Borrower, Collateral Agent (irrespective of whether the principal of any Loan, shall then be due and payable as herein expressed or by declaration or otherwise and irrespective of whether Collateral Agent shall have made any demand on Borrower) shall be entitled and empowered, by intervention in such proceeding or otherwise:

(a) to file and prove a claim for the whole amount of the principal and interest owing and unpaid in respect of the Credit Extensions and all other Obligations that are owing and unpaid and to file such other documents as may be necessary or advisable in order to have the claims of the Lenders and Collateral Agent (including any claim for the reasonable compensation, expenses, disbursements and advances of the Lenders and Collateral Agent and their respective agents and counsel and all other amounts due the Lenders and Collateral Agent allowed in such judicial proceeding); and

(b) to collect and receive any monies or other property payable or deliverable on any such claims and to distribute the same;

(c) and any custodian, receiver, assignee, trustee, liquidator, sequestrator or other similar official in any such judicial proceeding is hereby authorized by each Lender to make such payments to Collateral Agent and, in the event that Collateral Agent shall consent to the making of such payments directly to the Lenders, to pay to Collateral Agent any amount due for the reasonable compensation, expenses, disbursements and advances of Collateral Agent and its agents and counsel, and any other amounts due Collateral Agent under this Agreement. To the extent that Collateral Agent fails timely to do so, each Lender may file a claim relating to such Lender’s claim.

13.11 Collateral and Guaranty Matters. The Lenders irrevocably authorize Collateral Agent, at its option and in its discretion, to release any guarantor and any Lien on any Collateral granted to or held by Collateral Agent under any Loan Document (i) upon the date that all Obligations due hereunder have been fully and indefeasibly paid in full and no Commitment Amounts or other obligations of any Lender to provide funds to Borrower under this Agreement remain outstanding, (ii) that is transferred or to be transferred as part of or in connection with any Transfer permitted hereunder or under any other Loan Document, or (iii) as approved in accordance with Section 12.5. Upon request by Collateral Agent at any time, all Lenders will confirm in writing Collateral Agent's authority to release its interest in particular types or items of Property, pursuant to this Section 13.11.

13.12 Cooperation of Borrower. If necessary, Borrower agrees to (i) execute any documents reasonably required to effectuate and acknowledge each assignment of the Commitment Amount or Loan to an assignee in accordance with Section 12.1, (ii) make such Borrower's management available to meet with Collateral Agent and prospective participants and assignees of Commitment Amounts or Credit Extensions (which meetings shall be conducted no more often than twice every twelve months unless an Event of Default has occurred and is continuing), and (iii) assist Collateral Agent or the Lenders in the preparation of information relating to the financial affairs of Borrower as any prospective participant or assignee of the Commitment Amount or Revolving Line reasonably may request. Borrower authorizes each Lender to disclose to any prospective participant or assignee of the Commitment Amount, any and all information in such Lender's possession concerning Borrower and its financial affairs which has been delivered to such Lender by or on behalf of Borrower pursuant to this Agreement, or which has been delivered to such Lender by or on behalf of Borrower in connection with such Lender's credit evaluation of Borrower prior to entering into this Agreement, so long as any such Person enters into a confidentiality agreement or otherwise agrees to be bound by the terms of Section 12.8.

[Balance of Page Intentionally Left Blank]

IN WITNESS WHEREOF, the parties hereto have caused this Agreement to be executed as of the date first above written.

ENPHASE ENERGY, INC.

By: /s/ Paul Nahi

Title: President & Chief Executive Officer

COLLATERAL AGENT AND LENDER:

BRIDGE BANK, NATIONAL ASSOCIATION

By: /s/ Michael Lederman

Title: SVP

LENDER:

COMERICA BANK

By: /s/ Guy Simpson

Title: Vice President

[Signature Page to Amended and Restated Loan and Security Agreement]

SCHEDULE 1.1

COMMITMENT AMOUNTS AND PERCENTAGES

<u>Lender</u>	<u>Loan Commitment Amount</u>	<u>Commitment Percentage</u>
Bridge Bank, N.A.	\$ 15,000,000	60.00%
Comerica Bank	\$ 10,000,000	40.00%
TOTAL	\$ 25,000,000	100.00%

EXHIBIT A

DEBTOR: ENPHASE ENERGY, INC.
SECURED PARTY: BRIDGE BANK, NATIONAL ASSOCIATION and
COMERICA BANK

**COLLATERAL DESCRIPTION ATTACHMENT
TO AMENDED AND RESTATED LOAN AND SECURITY AGREEMENT**

All personal property of Borrower (herein referred to as "Borrower" or "Debtor") whether presently existing or hereafter created or acquired, and wherever located, including, but not limited to:

(a) all accounts (including health-care-insurance receivables), chattel paper (including tangible and electronic chattel paper), deposit accounts, documents (including negotiable documents), equipment (including all accessions and additions thereto), general intangibles (including payment intangibles and excluding Intellectual Property (as defined below)), goods (including fixtures), instruments (including promissory notes), inventory (including all goods held for sale or lease or to be furnished under a contract of service, and including returns and repossessions), investment property (including securities and securities entitlements), letter of credit rights, money, and all of Debtor's books and records with respect to any of the foregoing, and the computers and equipment containing said books and records;

(b) any and all cash proceeds and/or noncash proceeds of any of the foregoing, including, without limitation, insurance proceeds, and all supporting obligations and the security therefore or for any right to payment. All terms above have the meanings given to them in the California Uniform Commercial Code, as amended or supplemented from time to time.

Notwithstanding the foregoing, the Collateral shall not include any copyrights, patents, trademarks, servicemarks and applications therefore, now owned or hereafter acquired, or any claims for damages by way of any past, present and future infringement of any of the foregoing (collectively, the "Intellectual Property"); provided, however, that the Collateral shall include all accounts and general intangibles that consist of rights to payment and proceeds for the sale, licensing or disposition of all or any part, or rights in, the foregoing (the "Rights to Payment"). Notwithstanding the foregoing, if a judicial authority (including a U.S. Bankruptcy Court) holds that a security interest in the underlying Intellectual Property is necessary to have a security interest in the Rights to Payment, then the Collateral shall automatically, and effective as of the Closing Date, include the Intellectual Property to the extent necessary to permit perfection of each Secured Party's security interest in the Rights to Payment.

Notwithstanding the foregoing, the term "Collateral" shall not include (A) the capital stock of the controlled foreign corporation in excess of 65% of the voting power of all classes of capital stock of such controlled foreign corporation entitled to vote, (B) the Equipment identified on Annex I hereto, or (C) or rights of Borrower as a licensee; in each case of (B) and (C) to the extent the granting of a security interest therein (i) would be contrary to applicable law or (ii) is prohibited by or would constitute a default under any agreement or document governing such property (but only to the extent such prohibition is enforceable under applicable law); provided that upon the termination or lapsing of any such prohibition, such property shall automatically be part of the Collateral; and provided further that the provision of this paragraph shall in no case exclude from the definition of "Collateral" any Accounts, proceeds of the disposition of any property, or general intangibles consisting of rights to payment, all of which shall at all times constitute "Collateral"; and provided further that any Equipment financed by any Secured Party will at all times constitute "Collateral".

ANNEX I
(List of Equipment Excluded from Collateral)

[hard copy to be attached]

EXHIBIT B-1

BRIDGE BANK, N.A.

REVOLVING ADVANCE REQUEST

(To be submitted no later than 2:00 PM to be considered for same day processing)

To: Bridge Bank, National Association

Fax: _____

Date: _____

From: ENPHASE ENERGY, INC.

Authorized Signature

Authorized Signer's Name (please print)

Phone Number

To Account # _____

Borrower hereby request an Advance from Bridge Bank in the amount of \$_____; such amount represents 60% of the total Advance requested in the amount of \$_____ (the "Total Advance Amount"). Borrower is simultaneously requesting an Advance form Comerica Bank in the amount of \$_____, representing 40% of the Total Advance Amount.

Borrower hereby authorizes Lender to rely on facsimile stamp signatures and treat them as authorized by Borrower for the purpose of requesting the above advance.

All representations and warranties of Borrower stated in the Amended and Restated Loan and Security Agreement are true, correct and complete in all material respects as of the date of this Advance Request; provided that those representations and warranties expressly referring to another date shall be true, correct and complete in all material respects as of such date.

Capitalized terms used herein and not otherwise defined have the meanings set forth in the Amended and Restated Loan and Security Agreement.

EXHIBIT B-2

COMERICA BANK – TECHNOLOGY & LIFE SCIENCE DIVISION
LOAN ANALYSIS
LOAN ADVANCE/PAYDOWN REQUEST FORM

DEADLINE FOR SAME DAY PROCESSING IS 2:00* P.M., P.S.T.
DEADLINE FOR WIRE TRANSFERS IS 1:30 P.M., P.S.T.

*At month end and the day before a holiday, the cut off time is 1:30 P.M., P.S.T.
**Subject to 3 day advance notice.

To: Loan Analysis
FAX #: (650) 462-6061

DATE: _____ TIME: _____

FROM: ENPHASE ENERGY, INC.
Borrower's Name

TELEPHONE REQUEST (For Bank Use Only):

FROM: _____
Authorized Signer's Name

The following person is authorized to request the loan payment transfer/loan advance on the designated account and is known to me.

FROM: _____
Authorized Signature (Borrower)

Authorized Request & Phone #

PHONE #: _____

Received by (Bank) & Phone #

FROM ACCOUNT #: _____
(please include Note number, if applicable)

TO ACCOUNT #: _____

Authorized Signature (Bank)

(please include Note number, if applicable)

REQUESTED TRANSACTION TYPE

REQUEST DOLLAR AMOUNT

FOR BANK USE ONLY

PRINCIPAL INCREASE* (ADVANCE) \$ _____

Date Rec'd:

PRINCIPAL PAYMENT (ONLY) \$ _____

Time:

OTHER INSTRUCTION

Comp. Status: YES NO

Status Date:

Time:

Approval:

All representations and warranties of Borrower stated in the Loan Agreement are true, correct and complete in all material respects as of the date of the telephone request for and advance confirmed by this Borrowing Certificate; provided, however, that those representations and warranties the date expressly referring to another date shall be true, correct and complete in all material respects as of such date. Any advance amount requested herein represents 60% of the total Advance requested in the amount of \$_____ (the "Total Advance Amount"). Borrower is simultaneously requesting an Advance from Bridge Bank, NA, in the amount of \$_____, representing 60% of the Total Advance Amount.

*ISTHERE A WIRE REQUEST TIED TO THIS LOAN ADVANCE? (PLEASE CIRCLE ONE) YES NO

If YES, the Outgoing Wire Transfer Instructions must be completed below.

OUTGOING WIRE TRANSFER INSTRUCTIONS

Fed Reference Number

Bank Transfer Number

The Items marked with asterisk (*) are required to be completed.

- *Beneficiary Name
*Beneficiary Account Number
*Beneficiary Address
Currency Type
*ABA Routing Number (9 Digits)
*Receiving Institution Name
*Receiving Institution Address
*Wire Amount

US DOLLARS ONLY

\$

EXHIBIT C

**BORROWING BASE CERTIFICATE
BRIDGE BANK AND COMERICA BANK**

ENPHASE ENERGY, INC.:

ACCOUNTS RECEIVABLE BORROWING BASE CALCULATION:

As of Date: _____

1.	Add: Accounts Receivable Aged Current to 30 Days		\$0
2.	Add: Accounts Receivable Aged 31 to 60 days		\$0
3.	Add: Accounts Receivable Aged 61 to 90 days		\$0
4.	Add: Accounts Receivable Aged 91 Days and Over		\$0
5.	GROSS ACCOUNTS RECEIVABLE		\$ 0
6.	Less: Account Receivable Aged over	<u>90</u> days	\$0
7.	Less: U.S. Government Receivables (Net of > 90s)		\$0
8.	Less: Foreign Receivables (Net of > 90s)		\$0
9.	Less: Affiliate or Related Accounts Receivables (Net of > 90s)		\$0
10.	Less: Account concentration in excess of	<u>30%</u>	\$ 0 \$0
11.	Less: Cross Aging	<u>35%</u>	\$0
12.	Less: Contra Accounts, Prebills, Progress Billings, Retention bill and holds returns		\$0
13.	Less: Over 90 day A/R credits		\$0
14.	Add: Lines 6 through 13 - Total Ineligible Accounts		\$0
15.	NET ELIGIBLE ACCOUNTS RECEIVABLE		\$ 0
16.	Account Receivable Advance Rate		80%
17.	ACCOUNT RECEIVABLE BORROWING BASE		\$ 0
18.	INVENTORY		
19.	Eligible Inventory Value as of _____		
20.	ELIGIBLE AMOUNT OF INVENTORY (lesser of (1) 50% of #19 or (2) 50% of #17; not to exceed \$10,000,000)		
	MAXIMUM AVAILABLE LINE OF CREDIT		<u>\$ 0</u>
21.	Less: Outstanding Loan Balance		\$ 0
22.	AVAILABLE FOR DRAWN/NEED TO PAY		\$ 0

If line #22 is a negative number, this amount must be remitted to the Bank immediately to bring loan balance into compliance. By signing this form you authorize the bank to deduct any advance amounts directly from the company's checking account at Bridge Bank in the event there is an Over advance.

The undersigned represents and warrants that the foregoing is true, complete and correct, and that the information reflected in this Borrowing Base Certificate complies with the representations and warranties set forth in the Amended and Restated Loan and Security Agreement between the undersigned and Bridge Bank, National Association and Comerica Bank.

Prepared By:

Date: _____

Bank Reviewed:

Date: _____

EXHIBIT D

COMPLIANCE CERTIFICATE

TO: BRIDGE BANK, NATIONAL ASSOCIATION and COMERICA BANK

FROM: ENPHASE ENERGY, INC.

The undersigned authorized officer of ENPHASE ENERGY, INC. hereby certifies that in accordance with the terms and conditions of the Amended and Restated Loan and Security Agreement between Borrower, Bridge Bank, N.A. and Comerica Bank (the "Agreement"), (i) Borrower is in complete compliance for the period ending _____ with all required covenants except as noted below and (ii) all representations and warranties of Borrower stated in the Agreement are true and correct in all material respects as of the date hereof; provided, however that those representations and warranties expressly referring to another date shall be true, correct and complete in all material respects of such date. Attached herewith are the required documents supporting the above certification. The Officer further certifies that these are prepared in accordance with Generally Accepted Accounting Principles (GAAP) and are consistently applied from one period to the next except as explained in an accompanying letters or footnotes.

Please indicate compliance status by circling Yes/No under "Complies" column.

<u>Reporting Covenant</u>	<u>Required</u>	<u>Complies</u>	
Annual financial statements (CPA Audited)	FYI within 180 days	Yes	No
Monthly financial statements (consolidated), Compliance Certificate and deferred revenue report	Monthly within 30 days	Yes	No
Quarterly financial statements (consolidating) 10K and 10Q	Quarterly within 30 days (as applicable)	Yes	No
Annual operating budget, sales projections and operating plans approved by board of directors	Annual no later than 30 days after the end of each fiscal year	Yes	No
A/R & A/P Agings, Inventory Report, Borrowings Base Certificate	Prior to each Credit Extension, and monthly within 20 days	Yes	No
A/R Audit	Initial (within 30 days of close) and Semi-Annual thereafter	Yes	No
Inventory Exam	Prior to any Advance on "Eligible Inventory" and Annually thereafter	Yes	No
IP Report	Annually within 30 days, and promptly after filings with the USPTO and/or Copyright Office	Yes	No
Deposit balances with Bridge Bank	\$ _____		
Deposit balances with Comerica Bank	\$ _____		
Deposit balances outside Bridge Bank or Comerica Bank (explain on attachment)	\$ _____		
Amount/% of Total Cash maintained with foreign subsidiaries	\$ _____ /% _____ (may not exceed 5%)	Yes	No
<u>Financial Covenants</u>	<u>Required</u>	<u>Actual</u>	<u>Complies</u>
Minimum Asset Coverage Ratio (monthly)	1.50: 1.00	_____:1.00	Yes No
Minimum Tangible Net Worth (quarterly)	\$8,000,000*	\$ _____	Yes No
Minimum Unrestricted Cash in DDA at each of Bridge and Comerica	\$1,000,000**	\$ _____	Yes No

INSURANCE AUTHORIZATION LETTER

In accordance with the insurance coverage requirements of the AMENDED AND RESTATED LOAN AND SECURITY AGREEMENT dated as of March , 2011 (the "Agreement") between Bridge Bank, National Association ("Lender and Collateral Agent"), and ENPHASE ENERGY, INC. ("Borrower"), coverage is to be provided as set forth below:

COVERAGE: All risk including liability and property damage.

INSURED: ENPHASE ENERGY, INC.

LOCATION(S) OF COLLATERAL:

1. 201 1st St. Petaluma, CA 9495
2. Flextronics, Milpitas, CA
3. Flextronics Global Services 213 Harry Walker Parkway South New Marker Ontario, Canada

Insuring Agent: Marsh Risk and Insurance Services

Address: 1732 N. First St. Ste 400
San Jose, CA 95112

Phone Number:

Fax Number:

ADDITIONAL INSURED AND LOSS PAYEE

Lender, as its interest may appear below

BRIDGE BANK, NATIONAL ASSOCIATION
Collateral Agent
55 Almaden Blvd.
San Jose, CA 95113
Attn: Note Dept.

The above coverage is to be provided prior to funding the Agreement. Borrower hereby agrees to pay for the coverage above and by signing below acknowledges obligation to do so.

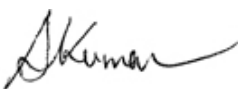
Signature: 
Sanjeev Kumar

Title: _____
Chief Financial Officer

Date: March 3, 2011



Agreement to Furnish Insurance to Loan and Security Agreement

(Herein called "Bank")

Borrower(s): ENPHASE ENERGY, INC.

I understand that the Security Agreement or Deed of Trust which I executed in connection with this transaction requires me to provide a physical damage insurance policy including a Lenders Loss Payable Endorsement in favor of the Bank as shown below, within ten (10) days from the date of this agreement.

The following minimum insurance must be provided according to the terms of the security documents.

AUTOMOBILES, TRUCKS, RECREATIONAL VEHICLES PERSONAL PROPERTY Comprehensive & Collision Lender's Loss Payable Endorsement

MACHINERY & EQUIPMENT: MISCELLANEOUS Fire & Extended Coverage Lender's Loss Payable Endorsement Breach of Warranty Endorsement

BOATS All Risk Hull Insurance Lender's Loss Payable Endorsement Breach of Warranty Endorsement

AIRCRAFT All Risk Ground & Flight Insurance Lender's Loss Payable Endorsement Breach of Warranty Endorsement

MOBILE HOMES Fire, Theft & Combined Additional Coverage Lender's Loss Payable Endorsement Earthquake

REAL PROPERTY Fire & Extended Coverage Lender's Loss Payable Endorsement All Risk Coverage Special Form Risk Coverage Earthquake Other

INVENTORY

Other

I may obtain the required insurance from any company that is reasonably acceptable to the Bank, and will deliver proof of such coverage with an effective date of March 24, 2011 or earlier.

I understand and agree that if I fail to deliver proof of insurance to the Bank at the address below, or upon the lapse or cancellation of such insurance, the Bank may procure lender's Single Interest Insurance or other similar coverage on the property. If the Bank procures insurance to protect its interest in the property described in the security documents, the cost for the insurance will be added to my indebtedness as provided in the security documents. Lender's Single Interest Insurance shall cover only the Bank's interest as a secured party, and shall become effective at the earlier of the funding date of this transaction or the date my insurance was cancelled or expired. I UNDERSTAND THAT LENDER'S SINGLE INTEREST INSURANCE WILL PROVIDE ME WITH ONLY LIMITED PROTECTION AGAINST PHYSICAL DAMAGE TO THE COLLATERAL, UP TO THE BALANCE OF THE LOAN, HOWEVER, MY EQUITY IN THE PROPERTY WILL NOT BE INSURED. FURTHER, THE INSURANCE WILL NOT PROVIDE MINIMUM PUBLIC LIABILITY OR PROPERTY DAMAGE INDEMNIFICATION AND DOES NOT MEET THE REQUIREMENTS OF THE FINANCIAL RESPONSIBILITY LAW.

CALIFORNIA CIVIL CODE SECTION 2955.5 HAZARD INSURANCE DISCLOSURE: No lender shall require a borrower, as a condition of receiving or maintaining a loan secured by real property, to provide hazard insurance coverage against risks to the improvements on that real property in an amount exceeding the replacement value of the improvements on the property.

Bank Address for Insurance Documents:

Comerica Bank - Collateral Operations, Mail Code 6514
1508 W. Mockingbird Lane
Dallas, Texas 75235

I acknowledge having read the provisions of this agreement, and agree to its terms. I authorize the Bank to provide to any person (including any insurance agent or company) any information necessary to obtain the insurance coverage required.

OWNER(S) OF COLLATERAL:

DATED: March 24, 2011

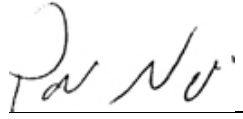

Paul Nahi – President & CEO

INSURANCE VERIFICATION

Date _____ Phone _____
Agents Name _____ Person Talked To _____
Agents Address _____
Insurance Company _____
Policy Number(s) _____
Effective Dates: From _____ To: _____
Deductible \$ _____ Comments: _____

CORPORATE RESOLUTIONS TO BORROW

Borrower: ENPHASE ENERGY, INC.

I, the undersigned Secretary or Assistant Secretary of ENPHASE ENERGY, INC. (the "Corporation"), HEREBY CERTIFY that the Corporation is organized and existing under and by virtue of the laws of the State of Delaware.

I FURTHER CERTIFY that attached hereto as Attachments 1 and 2 are true and complete copies of the Certificate of Incorporation, as amended, and the Restated Bylaws of the Corporation, each of which is in full force and effect on the date hereof.

I FURTHER CERTIFY that pursuant to the Unanimous Written Consent of the Directors of the Corporation, the following resolutions (the "Resolutions") were adopted.

BE IT RESOLVED, THAT ANY ONE (1) of the following named officers, employees, or agents of this Corporation, whose actual signatures are shown below:

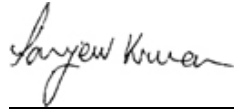
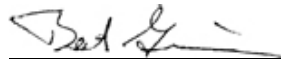
<u>NAMES</u>	<u>POSITION</u>	<u>ACTUAL SIGNATURES</u>
Paul Nahi	Chief Executive Officer	
Sanjeev Kumar	Chief Financial Officer	
Bert Garcia	Controller	

acting for and on behalf of this Corporation and as its act and deed be, and they hereby are, authorized and empowered:

Borrow Money. To borrow from time to time from Bridge Bank, National Association and Comerica Bank (collectively, the "Lenders"), on such terms as may be agreed upon between the officers, employees, or agents of the Corporation and the Lenders, such sum or sums of money as in their reasonable judgment should be borrowed, without limitation.

Executive Loan Documents. To execute and deliver to the Lenders that certain Amended and Restated Loan and Security Agreement dated as of March __, 2011 (the "Loan Agreement") and any other agreement entered into between Corporation and the Lenders in connection with the Loan Agreement, including any amendments, all as amended or extended from time to time (collectively, with the Loan Agreement, the "Loan Documents"), and also to execute and deliver to the Lenders one or more renewals, extensions, modifications, refinancings, consolidations, or substitutions for the Loan Documents, or any portion thereof.

Grant Security. To grant a security interest to Lenders in the Collateral described in the Loan Documents, which security interest shall secure all of the Corporation's Obligations, as described in the Loan Documents.

Negotiate Items. To draw, endorse, and discount with Lenders all drafts, trade acceptances, promissory notes, or other evidences of indebtedness payable to or belonging to the Corporation or in which the Corporation may have an interest, and either to receive cash for the same or to cause such proceeds to be credited to the account of the Corporation with Lenders, or to cause such other disposition of the proceeds derived therefrom as they may deem advisable.

Letters of Credit. To execute letter of credit applications and other related documents pertaining to Lenders' issuance of letters of credit.

Corporate Credit Cards. To execute corporate credit card applications and agreements and other related documents pertaining to Lender's provision of corporate credit cards.

Further Acts. In the case of lines of credit, to designate additional or alternated individuals as being authorized to request advances thereunder, and in all cases, to do and perform such other acts and things, to pay any and all fees and costs, and to execute and deliver such other documents and agreements as they may in their discretion deem reasonably necessary or proper in order to carry into effect the provisions of these Resolutions.

BE IT FURTHER RESOLVED, that any and all acts authorized pursuant to these resolutions and performed prior to the passage of these resolutions are hereby ratified and approved, that these Resolutions shall remain in full force and effect and Lenders may rely on these Resolutions until written notice of their revocation shall have been delivered to and received by Lenders. Any such notice shall not affect any of the Corporation's agreements or commitments in effect at the time notice is given.

I FURTHER CERTIFY that the officers, employees, and agents named above are duly elected, appointed, or employed by or for the Corporation, as the case may be, and occupy the positions set forth opposite their respective names; that the foregoing Resolutions now stand of record on the books of the Corporation; and that the Resolutions are in full force and effect and have not been modified or revoked in any manner whatsoever.

IN WITNESS WHEREOF, I have hereunto set my hand on March 24, 2011 and attest that the signatures set opposite the names listed above are their genuine signatures.

CERTIFIED AND ATTESTED BY:

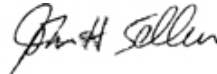
X 

LOAN AND SECURITY AGREEMENT

THIS LOAN AND SECURITY AGREEMENT is made and dated as of June 13, 2011 and is entered into by and between ENPHASE ENERGY, INC., a Delaware corporation ("Parent"), and each of Parent's other subsidiaries joined hereto ("Joined Subsidiaries", together with Parent hereinafter collectively referred to as the "Borrower"), and HERCULES TECHNOLOGY GROWTH CAPITAL, INC., a Maryland corporation ("Lender").

RECITALS

A. Borrower has requested Lender to make available to Borrower an equipment loan in an aggregate principal amount of up to Five Million (\$5,000,000) (the "Loan");

B. Lender is willing to make the Loan on the terms and conditions set forth in this Agreement.

AGREEMENT

NOW, THEREFORE, Borrower and Lender agree as follows:

SECTION 1. DEFINITIONS AND RULES OF CONSTRUCTION

1.1 Unless otherwise defined herein, the following capitalized terms shall have the following meanings:

"ACH Authorization" means the ACH Debit Authorization Agreement in substantially the form of Exhibit F.

"Advance(s)" means any Equipment Advance and/or Secondary Equipment Advance.

"Advance Date" means the funding date of any Advance.

"Advance Request" means a request for an Advance submitted by Borrower to Lender in substantially the form of Exhibit A.

"Agreement" means this Loan and Security Agreement, as amended from time to time.

"Assignee" has the meaning given to it in Section 11.13.

"Bailee Agreement" means a bailee agreement or warehouse agreement in form and substance reasonably acceptable to Lender.

"Borrower Products" means all products, software, service offerings, technical data or technology currently being designed, manufactured or sold by Borrower or which Borrower intends to sell, license, or distribute in the future including any products or service offerings under development, collectively, together with all products, software, service offerings,

technical data or technology that have been sold, licensed or distributed by Borrower since its incorporation.

“Cash” means all cash and liquid funds.

“Change in Control” means any (i) reorganization, recapitalization, consolidation or merger (or similar transaction or series of related transactions) of Borrower or any Subsidiary, sale or exchange of outstanding shares (or similar transaction or series of related transactions) of Borrower or any Subsidiary in which the holders of Borrower or Subsidiary’s outstanding shares immediately before consummation of such transaction or series of related transactions do not, immediately after consummation of such transaction or series of related transactions, retain shares representing more than fifty percent (50%) of the voting power of the surviving entity of such transaction or series of related transactions (or the parent of such surviving entity if such surviving entity is wholly owned by such parent), in each case without regard to whether Borrower or Subsidiary is the surviving entity, or (ii) sale or issuance by Borrower of new shares of Preferred Stock of Borrower to investors, none of whom are current investors in Borrower, and such new shares of Preferred Stock are senior to all existing Preferred Stock and Common Stock with respect to liquidation preferences, and the aggregate liquidation preference of the new shares of Preferred Stock is more than fifty percent (50%) of the aggregate liquidation preference of all shares of Preferred Stock of the Company; provided, however, an Initial Public Offering shall not constitute a Change in Control.

“Claims” has the meaning given to it in Section 11.10.

“Closing Date” means the date of this Agreement.

“Collateral” means the property described in Section 3.

“Confidential Information” has the meaning given to it in Section 11.12.

“Consent Letters” means letters from each of the Incumbent Lenders pursuant to which such Incumbent Lender agrees to deliver to Lender a Release Letter with respect to any Eligible Equipment prior to Lender making an Advance for such Eligible Equipment, in each case, in form and substance acceptable to Lender.

“Contingent Obligation” means, as applied to any Person, any direct or indirect liability, contingent or otherwise, of that Person with respect to (i) any indebtedness, lease, dividend, letter of credit or other obligation of another, including any such obligation directly or indirectly guaranteed, endorsed, co-made or discounted or sold with recourse by that Person, or in respect of which that Person is otherwise directly or indirectly liable; (ii) any obligations with respect to undrawn letters of credit, corporate credit cards or merchant services issued for the account of that Person; and (iii) all obligations arising under any interest rate, currency or commodity swap agreement, interest rate cap agreement, interest rate collar agreement, or other agreement or arrangement designated to protect a Person against fluctuation in interest rates, currency exchange rates or commodity prices; provided, however, that the term “Contingent Obligation” shall not include endorsements for collection or deposit in the ordinary course of business. The amount of any Contingent Obligation shall be deemed to be an amount equal to the

stated or determined amount of the primary obligation in respect of which such Contingent Obligation is made or, if not stated or determinable, the maximum reasonably anticipated liability in respect thereof as determined by such Person in good faith; provided, however, that such amount shall not in any event exceed the maximum amount of the obligations under the guarantee or other support arrangement.

“Copyrights” means all copyrights, whether registered or unregistered, held pursuant to the laws of the United States, any State thereof, or of any other country.

“Copyright License” means any written agreement granting any right to use any Copyright or Copyright registration, now owned or hereafter acquired by Borrower or in which Borrower now holds or hereafter acquires any interest.

“Effective Date” has the meaning given to it in Section 4.1.

“Eligible Equipment” is (a) Equipment used by Borrower in the ordinary course of business and (b) Secondary Equipment.

“Equipment Advance” means any Loan funds advanced under this Agreement that are not Secondary Equipment Advances.

“ERISA” is the Employee Retirement Income Security Act of 1974, and its regulations.

“Event of Default” has the meaning given to it in Section 9.

“Facility Charge” means \$50,000.

“Financed Equipment” means Eligible Equipment purchased by Borrower with Advances pursuant to Section 2.1.

“Financial Statements” has the meaning given to it in Section 7.1.

“GAAP” means generally accepted accounting principles in the United States of America, as in effect from time to time.

“Incumbent Lenders” means Atel Ventures, Inc., Compass Horizon Funding Company Inc. and Bridge Bank, National Association.

“Indebtedness” means indebtedness of any kind, including (a) all indebtedness for borrowed money or the deferred purchase price of property or services, including reimbursement and other obligations with respect to surety bonds and letters of credit, (b) all obligations evidenced by notes, bonds, debentures or similar instruments, (c) all capital lease obligations, and (d) all Contingent Obligations.

“Initial Public Offering” means the initial underwritten offering of Borrower’s common stock pursuant to a registration statement under the Securities Act of 1933 filed with and declared effective by the Securities and Exchange Commission.

“Insolvency Proceeding” is any proceeding by or against any Person under the United States Bankruptcy Code, or any other bankruptcy or insolvency law, including assignments for the benefit of creditors, compositions, extensions generally with its creditors, or proceedings seeking reorganization, arrangement, or other relief.

“Intellectual Property” means all of Borrower’s Copyrights; Trademarks; Patents; Licenses; trade secrets and inventions; mask works; Borrower’s applications therefor and reissues, extensions, or renewals thereof; and Borrower’s goodwill associated with any of the foregoing, together with Borrower’s rights to sue for past, present and future infringement of Intellectual Property and the goodwill associated therewith.

“Interest Rate” means the higher of (i) the Prime Rate plus 5.75% and (ii) 9.0%.

“International Based Financed Equipment” means Financed Equipment to be located, upon completion of transit, at (i) Flextronics International Ltd.’s (or its affiliates’) locations in (a) Canada and (b) China, or (ii) such other location outside of the United States approved in writing by Lender, in each case of subsection (i) and (ii), so long as such Financed Equipment is subject to a Bailee Agreement or a Landlord Consent, as applicable.

“Investment” means any beneficial ownership (including stock, partnership or limited liability company interests) of or in any Person, or any loan, advance or capital contribution to any Person.

“Investors” means existing investors in Borrower and certain affiliates of such investors.

“Investors’ Indebtedness” means subordinated convertible Indebtedness of Borrower in favor of Investors in an aggregate principal amount not to exceed \$50,000,000; provided, that the same is subject to the Investors Subordination Agreement.

“Investors Subordination Agreement” means that certain subordination agreement between the Investors and Lender, with respect to the Investors’ Indebtedness, in form and content acceptable to Lender in its sole discretion; provided, that without limiting the foregoing, the Investors Subordination Agreement shall provide, among other things, that (i) the Investors’ Indebtedness cannot be repaid before the Secured Obligations are indefeasibly repaid in full, in cash, and the Lender’s commitments to lend hereunder have been terminated, (ii) interest payable on account of the Investors’ Indebtedness may not be paid currently, or in cash, but must be accrued, if at all, as PIK (payment in kind; non-cash) interest, and (iii) no Investor or any agent or any representative of Investors may declare a default of the Investors’ Indebtedness or otherwise attempt to accelerate payment of the Investors’ Indebtedness (or otherwise pursue any rights or remedies with respect thereto, including with respect to any liens on any collateral) unless and until the Secured Obligations are indefeasibly repaid in full, in cash, and the Lender’s commitments to lend hereunder have been terminated.

“Joined Subsidiaries” has the meaning given to it in the preamble to this Agreement.

E. “Joinder Agreements” means for each Subsidiary, a completed and executed Joinder Agreement in substantially the form attached hereto as Exhibit

“Landlord Consent” means a landlord or mortgagee letter acceptable in form and substance acceptable to Lender.

“Lender” has the meaning given to it in the preamble to this Agreement.

“License” means any Copyright License, Patent License, Trademark License or other license of rights or interests.

“Lien” means any mortgage, deed of trust, pledge, hypothecation, assignment for security, security interest, encumbrance, levy, lien or charge of any kind, whether voluntarily incurred or arising by operation of law or otherwise, against any property, any conditional sale or other title retention agreement, and any lease in the nature of a security interest.

“Loan” means the Advances made under this Agreement.

“Loan Documents” means this Agreement, the Notes, the ACH Authorization, the Joinder Agreements, all UCC Financing Statements, Landlord Consents, Bailee Agreements, Consent Letters, Release Letters, the Warrant and any other documents executed in connection with the Secured Obligations or the transactions contemplated hereby, as the same may from time to time be amended, modified, supplemented or restated.

“Material Adverse Effect” means a material adverse effect upon: (i) the business, operations, properties, assets, or condition (financial or otherwise) of Borrower and its Subsidiaries taken as a whole; or (ii) the ability of Borrower to perform the Secured Obligations in accordance with the terms of the Loan Documents, or the ability of Lender to enforce any of its rights or remedies with respect to the Secured Obligations; or (iii) the Collateral, or Lender’s Liens on the Collateral or the priority of such Liens.

“Maturity Date” means July 1, 2014.

“Maximum Loan Amount” means Five Million and No/100 Dollars (\$5,000,000).

“Maximum Rate” shall have the meaning assigned to such term in Section 2.3.

“Note(s)” means a Promissory Note in substantially the form of Exhibit B.

“Patent License” means any written agreement granting any right with respect to any invention on which a Patent is in existence or a Patent application is pending, in which agreement Borrower now holds or hereafter acquires any interest.

“Patents” means all letters patent of, or rights corresponding thereto, in the United States or in any other country, all registrations and recordings thereof, and all applications for letters patent of, or rights corresponding thereto, in the United States or any other country.

“Permitted Indebtedness” means: (i) Indebtedness of Borrower in favor of Lender arising under this Agreement or any other Loan Document; (ii) Indebtedness existing on the Closing Date which is disclosed in Schedule 1A; (iii) Indebtedness to trade creditors incurred in the ordinary course of business, including Indebtedness incurred in the ordinary course of business with corporate credit cards; (iv) Indebtedness that also constitutes a Permitted Investment; (v) Subordinated Indebtedness; (vi) reimbursement obligations in connection with letters of credit that are secured by cash or cash equivalents and issued on behalf of the Borrower or a Subsidiary thereof in an amount not to exceed \$200,000 at any time outstanding, (vii) other Indebtedness in an amount not to exceed \$150,000 in the aggregate at any time outstanding, (viii) the Investors’ Indebtedness, and (ix) extensions, refinancings and renewals of any items of Permitted Indebtedness, provided that the principal amount is not increased or the terms modified to impose materially more burdensome terms upon Borrower or its Subsidiary, as the case may be.

“Permitted Investment” means: (i) Investments existing on the Closing Date which are disclosed in Schedule 1B; (ii) (a) marketable direct obligations issued or unconditionally guaranteed by the United States of America or any agency or any State thereof maturing within one year from the date of acquisition thereof, (b) commercial paper maturing no more than one year from the date of creation thereof and currently having a rating of at least A-2 or P-2 from either Standard & Poor’s Corporation or Moody’s Investors Service, (c) certificates of deposit issued by any bank with assets of at least \$500,000,000 maturing no more than one year from the date of investment therein, (d) money market accounts, and (e) Investments made in accordance with Borrower’s short-term investment policy as approved by Borrower’s Board of Directors, as submitted to Lender prior to the Closing Date; (iii) Investments consisting of the endorsement of negotiable instruments for deposit or collection or similar transactions in the ordinary course of business; (iv) repurchases of stock from former employees, directors, or consultants of Borrower under the terms of applicable repurchase agreements at the original issuance price of such securities in an aggregate amount not to exceed \$250,000 in any fiscal year, provided that no Event of Default has occurred, is continuing or would exist after giving effect to the repurchases; (v) Investments accepted in connection with Permitted Transfers; (vi) Investments (including debt obligations) received in connection with the bankruptcy or reorganization of customers or suppliers and in settlement of delinquent obligations of, and other disputes with, customers or suppliers arising in the ordinary course of Borrower’s business; (vii) Investments consisting of notes receivable of, or prepaid royalties and other credit extensions to, customers and suppliers who are not affiliates, in the ordinary course of business, provided that this clause (vii) shall not apply to Investments of Borrower in any Subsidiary; (viii) Investments consisting of loans not involving the net transfer on a substantially contemporaneous basis of cash proceeds to employees, officers or directors relating to the purchase of capital stock of Borrower pursuant to employee stock purchase plans or other similar agreements approved by Borrower’s Board of Directors; (ix) Investments consisting of travel advances and employee relocation loans and other employee loans which are made in the ordinary course of business and which do not exceed \$250,000 in the aggregate in any fiscal year; (x) Investments in newly-formed Subsidiaries organized in the United States, provided that such Subsidiaries enter into a Joinder Agreement promptly after their formation by Borrower and execute such other documents as shall be reasonably requested by Lender; (xi) Investments in Subsidiaries organized outside of the United States in an amount not to exceed \$4,500,000 in the aggregate in any fiscal year; (xii)

(A) joint ventures or strategic alliances in the ordinary course of Borrower's business consisting of the nonexclusive licensing of technology, the development of technology or the providing of technical support, provided, that any cash Investments by Borrower pursuant to this clause (xii)(A) do not exceed \$250,000 in the aggregate in any fiscal year, and (B) strategic alliances with particular customers in which such customers will share in the research and development expenses of Borrower associated with the incorporation by such customers of microconverters purchased from Borrower into solar panels produced by such customers; (xiii) Investments in connection with mergers or acquisitions permitted by Section 7.10; (xiv) Investments made pursuant to the conversion or settlement of any convertible securities or Indebtedness of Borrower permitted by Section 7.5; (xv) deposits and deposit accounts maintained with commercial banks organized under the laws of the United States or a state thereof to the extent (A) such deposits and deposit accounts are insured by the Federal Deposit Insurance Corporation up to the legal limit and (B) each such commercial bank has an aggregate capital and surplus of not less than \$100,000,000; and (xvi) additional Investments that do not exceed \$150,000 in the aggregate at any time outstanding.

"Permitted Liens" means any and all of the following: (i) Liens in favor of Lender; (ii) Liens for taxes, fees, assessments or other governmental charges or levies, either not delinquent or being contested in good faith by appropriate proceedings; provided, that Borrower maintains adequate reserves therefor in accordance with, and to the extent required by, GAAP; and (iii) Liens securing claims or demands of carriers, warehousemen, landlords and other like Persons arising in the ordinary course of Borrower's business and imposed without action of such parties; provided, that (a) the payment of the obligation secured by such Lien is not overdue and (b) such Collateral is subject to a Landlord Consent or a Bailee Agreement, as applicable;

"Permitted Transfers" means (i) sales of Inventory in the normal course of business, (ii) non-exclusive licenses and similar arrangements for the use of Intellectual Property in the ordinary course of business and other licenses that could not result in a legal transfer of title of the licensed property but that may be exclusive in respects other than territory and that may be exclusive as to territory only as to discrete geographical areas outside of the United States, (iii) dispositions of worn-out, obsolete or surplus Equipment (other than Financed Equipment) at fair market value (as determined by Borrower in its reasonable discretion) in the ordinary course of business, (iv) dispositions expressly permitted under Section 7.7, 7.8 or 7.10, and (v) other Transfers of assets having a fair market value of not more than \$250,000 in the aggregate in any fiscal year.

"Person" means any individual, sole proprietorship, partnership, joint venture, trust, unincorporated organization, association, corporation, limited liability company, institution, other entity or government.

"Preferred Stock" means at any given time any equity security issued by Borrower that has any rights, preferences or privileges senior to Borrower's common stock.

"Prime Rate" means for any day the prime rate as reported in The Wall Street Journal.

“Receivables” means (i) all of Borrower’s Accounts, Instruments, Documents, Chattel Paper, Supporting Obligations, letters of credit, proceeds of any letter of credit, and Letter of Credit Rights, and (ii) all customer lists, software, and business records related thereto.

“Release Letters” means letters from each of the Incumbent Lenders pursuant to which such Incumbent Lender agrees to release any interest in the Financed Equipment, in each case, in form and substance acceptable to Lender.

“Secondary Equipment” is leasehold improvements, intangible property including computer software and software licenses, equipment specifically designed or manufactured for Borrower, limited use property and other similar property (it being understood that, for purposes of this definition, equipment that is not specifically designed or manufactured for Borrower, but which is utilized by Borrower to assemble equipment that is specific to its business, shall not be deemed to be Secondary Equipment).

“Secondary Equipment Advance” means any Loan funds advanced under this Agreement to finance Secondary Equipment.

“Secured Obligations” means Borrower’s obligations under this Agreement and any Loan Document, including any obligation to pay any amount now owing or later arising; provided, however, that Borrower’s obligations under the Warrant shall not constitute Secured Obligations.

“Subordinated Indebtedness” means Indebtedness subordinated to the Secured Obligations in amounts and on terms and conditions satisfactory to Lender in its sole discretion.

“Subsidiary” means an entity, whether corporate, partnership, limited liability company, joint venture or otherwise, in which Borrower owns or controls 50% or more of the outstanding voting securities, including each entity listed on Schedule 1 hereto.

“Trademark License” means any written agreement granting any right to use any Trademark or Trademark registration, now owned or hereafter acquired by Borrower or in which Borrower now holds or hereafter acquires any interest.

“Trademarks” means all trademarks (registered, common law or otherwise) and any applications in connection therewith, including registrations, recordings and applications in the United States Patent and Trademark Office or in any similar office or agency of the United States, any State thereof or any other country or any political subdivision thereof.

“UCC” means the Uniform Commercial Code as the same is, from time to time, in effect in the State of California; provided, that in the event that, by reason of mandatory provisions of law, any or all of the attachment, perfection or priority of, or remedies with respect to, Lender’s Lien on any Collateral is governed by the Uniform Commercial Code as the same is, from time to time, in effect in a jurisdiction other than the State of California, then the term “UCC” shall mean the Uniform Commercial Code as in effect, from time to time, in such other jurisdiction solely for purposes of the provisions thereof relating to such attachment, perfection, priority or remedies and for purposes of definitions related to such provisions.

“Warrant” means the warrant entered into in connection with the Loan.

Unless otherwise specified, all references in this Agreement or any Annex or Schedule hereto to a “Section,” “subsection,” “Exhibit,” “Annex,” or “Schedule” shall refer to the corresponding Section, subsection, Exhibit, Annex, or Schedule in or to this Agreement. Unless otherwise specifically provided herein, any accounting term used in this Agreement or the other Loan Documents shall have the meaning customarily given such term in accordance with GAAP, and all financial computations hereunder shall be computed in accordance with GAAP, consistently applied. Unless otherwise defined herein or in the other Loan Documents, terms that are used herein or in the other Loan Documents and defined in the UCC shall have the meanings given to them in the UCC.

SECTION 2. THE LOAN

2.1 Loan.

(a) Advances. Subject to the terms and conditions of this Agreement, commencing on the Effective Date and continuing until December 13, 2011, Borrower may request Advances in the aggregate principal amount of the Maximum Loan Amount; provided, however, that the minimum amount of each Advance shall be \$100,000. If the aggregate amount of the Advances outstanding exceeds the Maximum Loan Amount at any time, Borrower must immediately pay Lender the excess. When repaid, the Advances may not be re-borrowed. The proceeds of each Advance may only be used to finance new Eligible Equipment or Eligible Equipment purchased within the immediately preceding 90 days (determined based upon the applicable invoice date of such Eligible Equipment); provided, however, that on the Effective Date, Borrower may draw an Advance of up to \$5,000,000 for Eligible Equipment purchased within the immediately preceding one eighty (180) days. No Advance may exceed one hundred percent (100%) of the invoice(s) for the applicable Eligible Equipment; provided, that the Advance made on the Effective Date will not exceed fifty percent (50%) of the invoice(s) for any Eligible Equipment with invoices in excess of one hundred twenty (120) days. Notwithstanding the foregoing, unless otherwise agreed to by Lender, (i) not more than 10% of each Advance shall be Secondary Equipment Advances, (ii) Secondary Equipment Advances shall not exceed \$500,000, in the aggregate, and (iii) Advances for International Based Financed Equipment shall not exceed \$3,750,000, in the aggregate.

(b) Advance Request. To obtain an Advance, Borrower shall complete, sign and deliver an Advance Request, Note, copies of invoices for the Financed Equipment, and such additional information as Lender may reasonably request at least five (5) business days prior to the requested Advance Date. Lender shall fund an Advance in the manner requested by the Advance Request provided that each of the conditions precedent to such Advance is satisfied as of the requested Advance Date.

(c) Interest. The principal balance of each Advance shall bear interest thereon from such Advance Date at the Interest Rate based on a year consisting of 360 days, with interest computed daily based on the actual number of days elapsed. The Interest Rate will float and change on the day the Prime Rate changes from time to time.

(d) Payment. Borrower will pay interest on each Advance on the first day of each month, beginning the month after the Advance Date of such Advance. Borrower shall repay the aggregate principal balance of all Advances that are outstanding on June 13, 2012 in 25 equal monthly installments of principal and interest beginning on July 1, 2012 and continuing on the first business day of each month thereafter through the Maturity Date. The entire Loan principal balance and all accrued but unpaid interest hereunder, shall be due and payable on the Maturity Date. Borrower shall make all payments under this Agreement without setoff, recoupment or deduction and regardless of any counterclaim or defense. Lender will initiate debit entries to the Borrower's account as authorized on the ACH Authorization on each payment date of all periodic obligations payable to Lender under each Note or Advance.

2.2 Maximum Interest. Notwithstanding any provision in this Agreement, the Notes, or any other Loan Document, it is the parties' intent not to contract for, charge or receive interest at a rate that is greater than the maximum rate permissible by law that a court of competent jurisdiction shall deem applicable hereto (which under the laws of the State of California shall be deemed to be the laws relating to permissible rates of interest on commercial loans) (the "Maximum Rate"). If a court of competent jurisdiction shall finally determine that Borrower has actually paid to Lender an amount of interest in excess of the amount that would have been payable if all of the Secured Obligations had at all times borne interest at the Maximum Rate, then such excess interest actually paid by Borrower shall be deemed retroactively applied as of the date of receipt of such payment as follows: first, to the payment of principal outstanding on the Notes; second, after all principal is repaid, to the payment of Lender's accrued interest, costs, expenses, professional fees and any other Secured Obligations; and third, after all Secured Obligations are repaid, the excess (if any) shall be refunded to Borrower.

2.3 Default Interest. In the event any payment is not paid on the scheduled payment date, an amount equal to five percent (5%) of the past due amount shall be payable on demand. In addition, upon the occurrence and during the continuation of an Event of Default hereunder, all Secured Obligations, including principal, interest, compounded interest, and Lender's fees and expenses set forth in Section 11.11, shall bear interest at a rate per annum equal to the rate set forth in Section 2.1(c) plus five percent (5%) per annum. In the event any interest is not paid when due hereunder, delinquent interest shall be added to principal and shall bear interest on interest, compounded at the rate set forth in Section 2.1(c) or Section 2.4, as applicable.

2.4 Prepayment. At its option upon at least 7 business days prior notice to Lender, Borrower may prepay all, but not less than all, of the outstanding Advances by paying the entire principal balance and all accrued and unpaid interest. Borrower shall prepay the outstanding amount of all principal and accrued and unpaid interest upon the earlier to occur of a Change in Control or within 90 days of the completion of an Initial Public Offering which results in aggregate gross proceeds to Parent of less than \$30,000,000.

2.5 End of Term Charge. On the earliest to occur of (i) the Loan Maturity Date, (ii) the date that Borrower prepays the outstanding Secured Obligations, or (iii) the date

that the Secured Obligations become due and payable, Borrower shall pay Lender a charge of \$50,000. Notwithstanding the required payment date of such charge, it shall be deemed earned by Lender as of the Closing Date.

SECTION 3. SECURITY INTEREST

3.1 As security for the prompt, complete and indefeasible payment when due (whether on the payment dates or otherwise) of all the Secured Obligations, Borrower grants to Lender a security interest in all Financed Equipment and all of Borrower's books and records relating to the Financed Equipment, and any and all claims, rights and interests in any of the Financed Equipment and all substitutions for, additions, attachments, accessories, accessions and improvements to and replacements, products, Proceeds and insurance proceeds of any or all of the foregoing (collectively, the "Collateral").

SECTION 4. CONDITIONS PRECEDENT TO LOAN

The obligations of Lender to make the Loan hereunder are subject to the satisfaction by Borrower of the following conditions:

4.1 Initial Advance. Borrower shall have delivered to Lender each of the following, in form and substance satisfactory to Lender (the date on which each of the following shall have been so delivered is referred to herein as the "Effective Date"):

(a) executed originals of the Loan Documents and all other documents and instruments reasonably required by Lender to effectuate the transactions contemplated hereby or to create and perfect the Liens of Lender with respect to all Collateral, in all cases in form and substance reasonably acceptable to Lender;

(b) certified copy of resolutions of Borrower's board of directors evidencing approval of (i) the Loan and other transactions evidenced by the Loan Documents; and (ii) the Warrant and transactions evidenced thereby;

(c) certified copies of the Certificate of Incorporation and the Bylaws, as amended through the Closing Date, of Borrower;

(d) a certificate of good standing for Borrower from its state of incorporation and similar certificates from all other jurisdictions in which it does business and where the failure to be qualified would have a Material Adverse Effect;

(e) a certificate of incumbency as to each officer of Borrower who is authorized to execute the Loan Documents, the Warrant, and all other documents and instruments to be delivered pursuant to the Loan Documents and the Warrant on behalf of Borrower, including, without limitation, the chief financial officer of Borrower;

(f) payment of the Facility Charge and reimbursement of Lender's current expenses reimbursable pursuant to this Agreement, which amounts may be deducted from the initial Advance;

(g) Landlord Consents or Bailee Agreements, as applicable, for the premises where the Financed Equipment will, upon completion of transit, be located; provided, that up to \$3,750,000 of the initial Advance may be used for the purchase of International Based Financed Equipment without delivering to Lender, prior to the disbursement of such Advance, any Landlord Consents in respect of the premises in the continental United States where such International Based Financed Equipment may be located temporarily, so long as (i) prior to the disbursement of such Advance, one or more Bailee Agreements, as applicable, are delivered in respect of the foreign premises where such International Based Financed Equipment will be located upon completion of transit, and (ii) within 90 days of the Effective Date (or any subsequent Advance Date with respect to any International Based Financed Equipment not financed on the Effective Date), such International Based Financed Equipment is relocated to such foreign premises;

(h) a Consent Letter from each Incumbent Lender;

(i) a Release Letter from each Incumbent Lender with respect to the Financed Equipment purchased with the proceeds of the initial Advance; and

(j) such other documents as Lender may reasonably request.

4.2 All Advances. On each Advance Date:

(a) Lender shall have received (i) an Advance Request and a Note for the relevant Advance as required by Section 2.1(b) each duly executed by Borrower's Chief Executive Officer or Chief Financial Officer, (ii) invoices for the Eligible Equipment and related other documentation as required by Section 2.1(b), (iii) to the extent not previously delivered but subject to Section 4.1(g) above, Landlord Consents or Bailee Agreements, as applicable, for the premises where the Financed Equipment will, upon completion of transit, be located, and (iv) a Release Letter from each Incumbent Lender with respect to the Financed Equipment purchased with the proceeds of such Advance.

(b) The representations and warranties set forth in this Agreement and in Section 5 and in the Warrant shall be true and correct in all material respects on and as of the Advance Date with the same effect as though made on and as of such date, except to the extent such representations and warranties expressly relate to an earlier date.

(c) Each Advance Request shall be deemed to constitute a representation and warranty by Borrower on the relevant Advance Date as to the matters specified in paragraph (b) of this Section 4.2 and Section 4.3 and as to the matters set forth in the Advance Request.

4.3 No Default. As of the Closing Date and each Advance Date, (i) no fact or condition exists that would (or would, with the passage of time, the giving of notice, or both) constitute an Event of Default and (ii) no event that has had or could reasonably be expected to have a Material Adverse Effect has occurred and is continuing.

SECTION 5. REPRESENTATIONS AND WARRANTIES OF BORROWER

Borrower represents and warrants that:

5.1 Corporate Status. Borrower is a corporation duly organized, legally existing and in good standing under the laws of the State of Delaware, and is duly qualified as a foreign corporation in all jurisdictions in which the nature of its business or location of its properties require such qualifications and where the failure to be qualified could reasonably be expected to have a Material Adverse Effect. Borrower's present name, former names (if any), locations, place of formation, tax identification number, organizational identification number and other information are correctly set forth in Exhibit C, as may be updated by Borrower in a written notice (including any Compliance Certificate) provided to Lender after the Closing Date.

5.2 Collateral. Borrower owns the Collateral, free of all Liens, except for Permitted Liens. Borrower has the power and authority to grant to Lender a Lien in the Collateral as security for the Secured Obligations.

5.3 Consents. Borrower's execution, delivery and performance of the Notes, this Agreement and all other Loan Documents, and Borrower's execution of the Warrant, (i) have been duly authorized by all necessary corporate action of Borrower, (ii) will not result in the creation or imposition of any Lien upon the Collateral, other than Permitted Liens and the Liens created by this Agreement and the other Loan Documents, (iii) do not violate any provisions of Borrower's Certificate or Articles of Incorporation (as applicable), bylaws, or any, law, regulation, order, injunction, judgment, decree or writ to which Borrower is subject and (iv) except as described on Schedule 5.3, do not violate any contract or agreement or require the consent or approval of any other Person. The individual or individuals executing the Loan Documents and the Warrant are duly authorized to do so.

5.4 Material Adverse Effect. Since December 31, 2010, no event that has had or could reasonably be expected to have a Material Adverse Effect has occurred and is continuing.

5.5 Actions Before Governmental Authorities. Except as described on Schedule 5.5, there are no actions, suits or proceedings at law or in equity or by or before any governmental authority (a) as of the Closing Date, pending or, to the knowledge of Borrower, threatened against or affecting Borrower or its property, and (b) following the Closing Date, which could reasonably be expected to have a Material Adverse Effect.

5.6 Laws. Borrower is not in violation of any law, rule or regulation, or in default with respect to any judgment, writ, injunction or decree of any governmental authority, where such violation or default is reasonably expected to result in a Material Adverse Effect. Borrower is not in default in any manner under any provision of any agreement or instrument evidencing indebtedness, or any other material agreement to which it is a party or by which it is bound.

5.7 Information Correct and Current. No information, report, Advance Request, financial statement, exhibit or schedule furnished, by or on behalf of Borrower to Lender in

connection with any Loan Document or included therein or delivered pursuant thereto contained, contains or will contain any material misstatement of fact or omitted, omits or will omit to state any material fact necessary to make the statements therein, in the light of the circumstances under which they were, are or will be made, not misleading at the time such statement was made or deemed made. Additionally, any and all financial or business projections provided by Borrower to Lender shall be (i) provided in good faith and based on the most current data and information available to Borrower, and (ii) the most current of such projections approved by Borrower's Board of Directors.

5.8 Tax Matters. Except as described on Schedule 5.8, (a) Borrower has filed all federal and material state and local tax returns that it is required to file and all such tax returns are true and correct in all material respects, (b) Borrower has duly paid or fully reserved for all taxes or installments thereof (including any interest or penalties) as and when due, which have or may become due pursuant to such returns, and (c) Borrower has paid or fully reserved for any tax assessment received by Borrower for the three (3) years preceding the Closing Date, if any (including any taxes being contested in good faith and by appropriate proceedings).

5.9 Intellectual Property Claims. Borrower is the sole owner of, or otherwise has the right to use, the Intellectual Property. Except as described on Schedule 5.9, (i) each of the material Copyrights, Trademarks and Patents is valid and enforceable, (ii) no material part of the Intellectual Property has been judged invalid or unenforceable, in whole or in part, and (iii) no claim has been made to Borrower that any material part of the Intellectual Property violates the rights of any third party.

5.10 Intellectual Property. Except as described on Schedule 5.10, Borrower has all material rights with respect to Intellectual Property necessary in the operation or other utilization of the Collateral. Without limiting the generality of the foregoing, and in the case of Licenses, except for restrictions that are unenforceable under Division 9 of the UCC, Borrower has the right, to the extent required to grant a security interest in and operate or otherwise utilize the Collateral, to freely transfer, license or assign the related Intellectual Property without condition, restriction or payment of any kind (other than license payments in the ordinary course of business) to any third party.

5.11 [Reserved.]

5.12 [Reserved.]

5.13 Employee Loans. (i) Except as expressly permitted by Sections 7.7 and 7.8, Borrower has no outstanding loans to any employee, officer or director of the Borrower, and (ii) Borrower has not guaranteed the payment of any loan made to an employee, officer or director of the Borrower by a third party.

5.14 Capitalization and Subsidiaries. Borrower's capitalization as of the Closing Date is set forth on Schedule 5.14 annexed hereto. Borrower does not own any stock, partnership interest or other securities of any Person, except for Permitted Investments.

Attached as Schedule 5.14, as may be updated by Borrower in a written notice provided after the Closing Date, is a true, correct and complete list of each Subsidiary.

SECTION 6. INSURANCE; INDEMNIFICATION

6.1 Coverage. Borrower shall cause to be carried and maintained commercial general liability insurance, on an occurrence form, against risks customarily insured against in Borrower's line of business. Such risks shall include the risks of bodily injury, including death, property damage, personal injury, advertising injury, and contractual liability per the terms of the indemnification agreement found in Section 6.3. Borrower must maintain a minimum of \$1,000,000 of commercial general liability insurance for each occurrence. So long as there are any Secured Obligations outstanding, Borrower shall also cause to be carried and maintained insurance upon the Collateral, insuring against all risks of physical loss or damage howsoever caused, in an amount not less than the full replacement cost of the Collateral, provided that such insurance may be subject to standard exceptions and deductibles. Borrower shall also carry and maintain a fidelity insurance policy in an amount not less than \$100,000.

6.2 Certificates. Borrower shall deliver to Lender certificates of insurance that evidence Borrower's compliance with its insurance obligations in Section 6.1 and the obligations contained in this Section 6.2. Borrower's insurance certificate shall state Lender is an additional insured for commercial general liability, an additional insured and a loss payee for all risk property damage insurance, subject to the insurer's approval, a loss payee for property insurance. Attached to the certificates of insurance will be additional insured endorsements, or copies of policy forms evidencing Lender is an additional insured, for liability and lender's loss payable endorsements for all risk property damage insurance. All certificates of insurance will provide for advance written notice to Lender of cancellation. Promptly upon Lender's request, Borrower shall provide evidence of current payment of insurance premiums in form and substance reasonably satisfactory to Lender. Any failure of Lender to scrutinize such insurance certificates or such evidence of payment of premiums for compliance is not a waiver of any of Lender's rights, all of which are reserved.

6.3 Indemnity. Borrower agrees to indemnify and hold Lender and its officers, directors, employees, agents, in-house attorneys, representatives and shareholders harmless from and against any and all claims, costs, expenses, damages and liabilities (including such claims, costs, expenses, damages and liabilities based on liability in tort, including strict liability in tort), including reasonable attorneys' fees and disbursements and other costs of investigation or defense (including those incurred upon any appeal), that may be instituted or asserted against or incurred by Lender or any such Person as the result of credit having been extended, suspended or terminated under this Agreement and the other Loan Documents or the administration of such credit, or in connection with or arising out of the transactions contemplated hereunder and thereunder, or any actions or failures to act in connection therewith, or arising out of the disposition or utilization of the Collateral, excluding in all cases claims resulting solely from Lender's gross negligence or willful misconduct. Borrower agrees to pay, and to save Lender harmless from, any and all

liabilities with respect to, or resulting from any delay in paying, any and all excise, sales or other similar taxes (excluding taxes imposed on or measured by the net income of Lender) that may be payable or determined to be payable with respect to any of the Collateral or this Agreement.

SECTION 7. COVENANTS OF BORROWER

Borrower agrees as follows:

7.1 Financial Reports. Borrower shall furnish to Lender the Compliance Certificate in the form of Exhibit D monthly within 30 days after the end of each month and the financial statements listed hereinafter (the "Financial Statements"):

(a) as soon as practicable (and in any event, within 30 days after the end of each of the first two months of each fiscal quarter, and within 45 days after the end of the last month of each fiscal quarter), unaudited interim and year-to-date financial statements as of the end of such month (prepared on a consolidated basis), including balance sheet and related statements of income and cash flows accompanied by a report detailing any material contingencies (including the commencement of any material litigation by or against Borrower) or any other occurrence that would reasonably be expected to have a Material Adverse Effect, all certified by Borrower's Chief Executive Officer or Chief Financial Officer to the effect that they have been prepared in accordance with GAAP, except (i) for the absence of footnotes, (ii) that they are subject to normal year end adjustments, and (iii) they do not contain certain non-cash items that are customarily included in quarterly and annual financial statements;

(b) as soon as practicable (and in any event within 45 days) after the end of each calendar quarter, unaudited interim and year-to-date financial statements as of the end of such calendar quarter (prepared on a consolidated and consolidating basis, if applicable), including balance sheet and related statements of income and cash flows accompanied by a report detailing any material contingencies (including the commencement of any material litigation by or against Borrower) or any other occurrence that would reasonably be expected to have a Material Adverse Effect, certified by Borrower's Chief Executive Officer or Chief Financial Officer to the effect that they have been prepared in accordance with GAAP, except (i) for the absence of footnotes, and (ii) that they are subject to normal year end adjustments; as well as the most recent capitalization table for Borrower, including the weighted average exercise price of employee stock options;

(c) as soon as practicable (and in any event within 180 days) after the end of each fiscal year (beginning with the 2011 fiscal year of Parent), unqualified audited financial statements as of the end of such year (prepared on a consolidated and consolidating basis, if applicable), including balance sheet and related statements of income and cash flows, and setting forth in comparative form the corresponding figures for the preceding fiscal year, certified by a firm of independent certified public accountants selected by Borrower and reasonably acceptable to Lender (it being

understood that Deloitte & Touch LLP is acceptable to Lender), accompanied by any management report from such accountants;

(d) promptly after the sending or filing thereof, as the case may be, copies of any proxy statements, financial statements or reports that Borrower has made available to holders of its stock and copies of any regular, periodic and special reports or registration statements that Borrower files with the Securities and Exchange Commission or any governmental authority that may be substituted therefor, or any national securities exchange;

(e) [Reserved]; and

(f) financial and business projections promptly following their approval by Borrower's Board of Directors, as well as operating plans and other financial information reasonably requested by Lender; provided, that annual budget projections approved by the Borrower's Board of Directors with respect to any fiscal year shall be delivered to Lender no later than 30 days after the end of the immediately preceding fiscal year of Borrower.

The executed Compliance Certificate may be sent via facsimile to Lender at (650) 473-9194 or via e-mail to tfissori@herculestech.com. All Financial Statements required to be delivered pursuant to clauses (a), (b) and (c) shall be sent via e-mail to financialstatements@herculestech.com with a copy to tfissori@herculestech.com provided, that if e-mail is not available or sending such Financial Statements via e-mail is not possible, they shall be sent via facsimile to Lender at: (866) 468-8916, attention Chief Credit Officer.

7.2 Collateral Audits; Management Rights. Borrower shall permit any representative that Lender authorizes, including its attorneys and accountants, to inspect the Collateral and examine and make copies and abstracts of the books of account and records of Borrower relating to the Collateral at reasonable times and upon reasonable notice during normal business hours; provided, that such inspections will be conducted no more than once every 6 months unless an Event of Default has occurred and is continuing. In addition, any such representative shall have the right to meet with management and officers of Borrower to discuss Borrower's books of account and records. In addition, Lender shall be entitled at reasonable times and intervals to consult with and advise the management and officers of Borrower concerning significant business issues affecting Borrower. Such consultations shall not unreasonably interfere with Borrower's business operations. The parties intend that the rights granted Lender shall constitute "management rights" within the meaning of 29 C.F.R Section 2510.3-101(d)(3)(ii), but that any advice, recommendations or participation by Lender with respect to any business issues shall not be deemed to give Lender, nor be deemed an exercise by Lender of, control over Borrower's management or policies.

7.3 Further Assurances. Borrower shall from time to time execute, deliver and file, alone or with Lender, any financing statements, security agreements, collateral assignments, notices, control agreements, or other documents to perfect or give the highest priority to Lender's Lien on the Collateral. Borrower shall from time to time procure any

instruments or documents as may be requested by Lender, and take all further action that may be necessary or desirable, or that Lender may reasonably request, to perfect and protect the Liens granted hereby and thereby. In addition, and for such purposes only, Borrower hereby authorizes Lender to execute and deliver on behalf of Borrower and to file such financing statements, collateral assignments, notices, security agreements and other documents without the signature of Borrower either in Lender's name or in the name of Lender as agent and attorney-in-fact for Borrower. Borrower shall protect and defend Borrower's title to the Collateral and Lender's Lien thereon against all Persons claiming any interest adverse to Borrower or Lender other than Permitted Liens. Borrower shall specify in writing the location where each item of Collateral is located promptly upon the request of Lender.

7.4 [Reserved.]

7.5 Indebtedness. Borrower shall not create, incur, assume, guarantee or be or remain liable with respect to any Indebtedness, or permit any Subsidiary so to do, other than Permitted Indebtedness, or prepay any Indebtedness or take any actions which impose on Borrower an obligation to prepay any Indebtedness (other than Indebtedness described in clause (ii) or, subject to the Investors Subordination Agreement, (viii) of the definition of Permitted Indebtedness, in each case as modified by clause (ix) of such definition), except for the conversion of Indebtedness into equity securities and the payment of cash in lieu of fractional shares in connection with such conversion.

7.6 Collateral. Borrower shall at all times keep the Collateral free and clear from any legal process or Liens whatsoever (except for Permitted Liens), and shall give Lender prompt written notice of any legal process affecting the Collateral or any Liens thereon. Borrower shall not affix, or allow the affixing of, any of the Financed Equipment to any real property in such a manner, or with such intent, as to become a fixture.

7.7 Investments. Borrower shall not directly or indirectly acquire or own, or make any Investment in or to any Person, or permit any of its Subsidiaries so to do, other than Permitted Investments.

7.8 Distributions. Borrower shall not, and shall not allow any Subsidiary to, (a) repurchase or redeem any class of stock or other equity interest other than (i) pursuant to employee, director or consultant stock purchase or repurchase plans or other similar agreements, and (ii) in connection with conversions of its convertible securities (including warrants) into other securities pursuant to the terms of such convertible securities, or (b) declare or pay any cash dividend or make a cash distribution on any class of stock or other equity interest, except that a Subsidiary may pay dividends or make distributions to Parent, or (c) lend money to any employees, officers or directors except as expressly permitted by clause (viii), (ix) or (xvi) of the definition of Permitted Investments, or (d) waive, release or forgive any indebtedness owed by any employees, officers or directors in excess of \$500,000 in the aggregate.

7.9 Transfers. Except for Permitted Transfers, Borrower shall not voluntarily or involuntarily transfer, sell, lease, license, lend or in any other manner convey any equitable, beneficial or legal interest in any material portion of their assets.

7.10 Mergers or Acquisitions. Borrower shall not merge or consolidate, or permit any of its Subsidiaries to merge or consolidate, with or into any other business organization (other than mergers or consolidations of a Subsidiary into another Subsidiary or into Borrower), or acquire, or permit any of its Subsidiaries to acquire, all or substantially all of the capital stock, assets or property of another Person without the prior written consent of Lender.

7.11 Taxes. Borrower and its Subsidiaries shall pay when due all material taxes, fees or other charges of any nature whatsoever (together with any related interest or penalties) now or hereafter imposed or assessed by applicable law against Borrower, Lender (assessed in connection with the making of the Loan hereunder but excluding any taxes on Lender's net income), or the Collateral or upon Borrower's ownership, possession, use, operation or disposition thereof or upon Borrower's rents, receipts or earnings arising therefrom. Borrower shall file on or before the due date therefor all personal property tax returns in respect of the Collateral, if necessary or appropriate. Notwithstanding the foregoing, Borrower may contest, in good faith and by appropriate proceedings, taxes for which Borrower maintains adequate reserves therefor in accordance with GAAP.

7.12 Corporate Changes; Changes in Location of Collateral. Neither Borrower nor any Subsidiary shall change its corporate name, legal form or jurisdiction of formation without twenty (20) days' prior written notice to Lender. Neither Borrower nor any Subsidiary shall relocate its chief executive office or its principal place of business unless: (i) it has provided prior written notice to Lender; and (ii) such relocation shall be within the continental United States. Neither Borrower nor any Subsidiary shall relocate any item of Collateral unless (y) in the case of Equipment other than International Based Financed Equipment, such relocation is within the continental United States, and (z) such Collateral at all times remains subject to a Landlord Consent or a Bailee Agreement, as applicable, which is valid and enforceable against the Person in possession of such Collateral or the premises where such Collateral is located.

7.13 [Reserved.]

7.14 Subsidiaries. Borrower shall notify Lender of each Subsidiary formed subsequent to the Closing Date and, within 30 days of formation, shall cause any such domestic Subsidiary so formed to execute and deliver to Lender a Joinder Agreement.

7.15 Post-Closing Matters. If any International Based Financed Equipment is not located at a permitted foreign location, or is not in transit thereto, within 90 days following the Advance Date applicable to such International Based Financed Equipment, then Borrower shall deliver, or cause to be delivered, promptly to Lender fully-executed Landlord Consents for any premises where such International Based Financed Equipment is located.

SECTION 8. [RESERVED.]

SECTION 9. EVENTS OF DEFAULT

The occurrence of any one or more of the following events shall be an Event of Default:

9.1 Payments. Borrower fails to pay any amount due under this Agreement, the Notes or any of the other Loan Documents on the due date; or

9.2 Covenants. Borrower breaches or defaults in the performance of any covenant or Secured Obligation under this Agreement, the Notes, or any of the other Loan Documents, and (a) with respect to a default under any covenant under this Agreement (other than under Sections 6, 7.5, 7.6, 7.7, 7.8 or 7.9) which is capable of being cured by Borrower, such default continues for more than twenty (20) days after the earlier of the date on which (i) Lender has given notice of such default to Borrower and (ii) Borrower has actual knowledge of such default, or (b) with respect to a default under any of Sections 6, 7.5, 7.6, 7.7, 7.8 or 7.9, the occurrence of such default; or

9.3 Material Adverse Effect. A circumstance has occurred that would reasonably be expected to have a Material Adverse Effect; or

9.4 Other Loan Documents. The occurrence of any default under any Loan Document not otherwise specifically referenced in this Section 9 or any other agreement between Borrower and Lender, and if such default is capable of being cured by Borrower, such default continues for more than twenty (20) days after the earlier of the date on which (a) Lender has given notice of such default to Borrower, or (b) Borrower has actual knowledge of such default; or

9.5 Representations. Any representation or warranty made by Borrower in any Loan Document or in the Warrant shall have been false or misleading in any material respect; or

9.6 Insolvency. Borrower (A) (i) shall make an assignment for the benefit of creditors; or (ii) shall be unable to pay its debts as they become due, or be unable to pay or perform under the Loan Documents, or shall otherwise become insolvent; or (iii) shall file a voluntary petition in bankruptcy; or (iv) shall file any petition, answer, or document seeking for itself any reorganization, arrangement, composition, readjustment, liquidation, dissolution or similar relief under any present or future statute, law or regulation pertinent to such circumstances; or (v) shall seek or consent to or acquiesce in the appointment of any trustee, receiver, or liquidator of Borrower or of all or any substantial part (i.e., 33-1/3% or more) of the assets or property of Borrower; or (vi) shall cease operations of its business as its business has normally been conducted, or terminate substantially all of its employees; or (vii) Borrower or its directors or majority shareholders shall take any action initiating any of the foregoing actions described in clauses (i) through (vi); or (B) either (i) forty-five (45) days shall have expired after the commencement of an involuntary action against Borrower seeking reorganization, arrangement, composition, readjustment, liquidation, dissolution or similar relief under any present or future statute, law or

regulation, without such action being dismissed or all orders or proceedings thereunder affecting the operations or the business of Borrower being stayed; or (ii) a stay of any such order or proceedings shall thereafter be set aside and the action setting it aside shall not be timely appealed; or (iii) Borrower shall file any answer admitting or not contesting the material allegations of a petition filed against Borrower in any such proceedings; or (iv) the court in which such proceedings are pending shall enter a decree or order granting the relief sought in any such proceedings; or (v) forty-five (45) days shall have expired after the appointment, without the consent or acquiescence of Borrower, of any trustee, receiver or liquidator of Borrower or of all or any substantial part of the properties of Borrower without such appointment being vacated; or

9.7 Attachments; Judgments. Any portion of Borrower's assets is attached or seized, or a levy is filed against any such assets, or a judgment or judgments is/are entered for the payment of money, individually or in the aggregate, of at least \$250,000 and such judgment remains unstayed for a period of ten (10) days, or Borrower is enjoined or in any way prevented by court order from conducting any part of its business; or

9.8 Other Obligations. The occurrence of any default under any agreement or obligation of Borrower involving any Indebtedness which results in a right by a third party or parties, whether or not exercised, to accelerate the maturity of such Indebtedness in excess of \$250,000, or the occurrence of any default under any agreement or obligation of Borrower that could reasonably be expected to have a Material Adverse Effect.

SECTION 10. REMEDIES

10.1 General. Upon and during the continuance of any one or more Events of Default, (i) Lender may, at its option, accelerate and demand payment of all or any part of the Secured Obligations and declare them to be immediately due and payable (provided, that upon the occurrence of an Event of Default of the type described in Section 9.6, the Notes and all of the Secured Obligations shall automatically be accelerated and made due and payable, in each case without any further notice or act), and (ii) Lender may notify any of Borrower's account debtors to make payment directly to Lender, compromise the amount of any such account on Borrower's behalf and endorse Lender's name without recourse on any such payment for deposit directly to Lender's account. Lender may exercise all rights and remedies with respect to the Collateral under the Loan Documents or otherwise available to it under the UCC and other applicable law, including the right to release, hold, sell, lease, liquidate, collect, realize upon, or otherwise dispose of all or any part of the Collateral and the right to occupy, utilize, process and commingle the Collateral. All Lender's rights and remedies shall be cumulative and not exclusive.

10.2 Collection; Foreclosure. Upon the occurrence and during the continuance of any Event of Default, Lender may, at any time or from time to time, apply, collect, liquidate, sell in one or more sales, lease or otherwise dispose of, any or all of the Collateral, in its then condition or following any commercially reasonable preparation or processing, in such order as Lender may elect. Any such sale may be made either at public or private sale at its place of business or elsewhere. Borrower agrees that any such public or private sale may occur upon ten (10) calendar days' prior written notice to Borrower.

Lender may require Borrower to assemble the Collateral and make it available to Lender at a place designated by Lender that is reasonably convenient to Lender and Borrower. The proceeds of any sale, disposition or other realization upon all or any part of the Collateral shall be applied by Lender in the following order of priorities:

First, to Lender in an amount sufficient to pay in full Lender's costs and professionals' and advisors' fees and expenses as described in Section 11.11;

Second, to Lender in an amount equal to the then unpaid amount of the Secured Obligations (including principal, interest, and the Default Rate interest), in such order and priority as Lender may choose in its sole discretion; and

Finally, after the full, final, and indefeasible payment in Cash of all of the Secured Obligations, to any creditor holding a junior Lien on the Collateral, or to Borrower or its representatives or as a court of competent jurisdiction may direct.

Lender shall be deemed to have acted reasonably in the custody, preservation and disposition of any of the Collateral if it complies with the obligations of a secured party under the UCC.

10.3 No Waiver. Lender shall be under no obligation to marshal any of the Collateral for the benefit of Borrower or any other Person, and Borrower expressly waives all rights, if any, to require Lender to marshal any Collateral.

10.4 Cumulative Remedies. The rights, powers and remedies of Lender hereunder shall be in addition to all rights, powers and remedies given by statute or rule of law and are cumulative. The exercise of any one or more of the rights, powers and remedies provided herein shall not be construed as a waiver of or election of remedies with respect to any other rights, powers and remedies of Lender.

SECTION 11. MISCELLANEOUS

11.1 Severability. Whenever possible, each provision of this Agreement shall be interpreted in such manner as to be effective and valid under applicable law, but if any provision of this Agreement shall be prohibited by or invalid under such law, such provision shall be ineffective only to the extent and duration of such prohibition or invalidity, without invalidating the remainder of such provision or the remaining provisions of this Agreement.

11.2 Notice. Except as otherwise provided herein, any notice, demand, request, consent, approval, declaration, service of process or other communication (including the delivery of Financial Statements) that is required, contemplated, or permitted under the Loan Documents or with respect to the subject matter hereof shall be in writing, and shall be deemed to have been validly served, given, delivered, and received upon the earlier of: (i) the day of transmission by facsimile or hand delivery or delivery by an overnight express service or overnight mail delivery service; or (ii) the third calendar day after deposit in the United States mails, with proper first class postage prepaid, in each case addressed to the party to be notified as follows:

(a) If to Lender:
HERCULES TECHNOLOGY GROWTH CAPITAL, INC.
Legal Department
Attention: Chief Legal Officer and Todd Jaquez-Fissori
400 Hamilton Avenue, Suite 310
Palo Alto, CA 94301

(b) If to Borrower:
ENPHASE ENERGY, INC.
Attention: Chief Financial Officer
201 First Street, Suite 300
Petaluma, CA 94952

or to such other address as each party may designate for itself by like notice.

11.3 Entire Agreement; Amendments. This Agreement, the Notes, and the other Loan Documents constitute the entire agreement and understanding of the parties hereto in respect of the subject matter hereof and thereof, and supersede and replace in their entirety any prior proposals, term sheets, letters, negotiations or other documents or agreements, whether written or oral, with respect to the subject matter hereof or thereof (including Lender's revised proposal letter dated March 30, 2011). None of the terms of this Agreement, the Notes or any of the other Loan Documents may be amended except by an instrument executed by each of the parties hereto.

11.4 No Strict Construction. The parties hereto have participated jointly in the negotiation and drafting of this Agreement. In the event an ambiguity or question of intent or interpretation arises, this Agreement shall be construed as if drafted jointly by the parties hereto and no presumption or burden of proof shall arise favoring or disfavoring any party by virtue of the authorship of any provisions of this Agreement.

11.5 No Waiver. The powers conferred upon Lender by this Agreement are solely to protect its rights hereunder and under the other Loan Documents and its interest in the Collateral and shall not impose any duty upon Lender to exercise any such powers. No omission or delay by Lender at any time to enforce any right or remedy reserved to it, or to require performance of any of the terms, covenants or provisions hereof by Borrower at any time designated, shall be a waiver of any such right or remedy to which Lender is entitled, nor shall it in any way affect the right of Lender to enforce such provisions thereafter.

11.6 Survival. All agreements, representations and warranties contained in this Agreement, the Notes and the other Loan Documents or in any document delivered pursuant hereto or thereto shall be for the benefit of Lender and shall survive the execution and delivery of this Agreement and the expiration or other termination of this Agreement.

11.7 Successors and Assigns. The provisions of this Agreement and the other Loan Documents shall inure to the benefit of and be binding on Borrower and its permitted assigns (if any). Borrower shall not assign its obligations under this Agreement, the Notes or any of the other Loan Documents without Lender's express prior written consent, and any such attempted assignment shall be void and of no effect. Lender may assign, transfer, or endorse its rights hereunder and under the other Loan Documents without prior notice to Borrower, and all of such rights shall inure to the benefit of Lender's successors and assigns.

11.8 Governing Law. This Agreement, the Notes and the other Loan Documents have been negotiated and delivered to Lender in the State of California, and shall have been accepted by Lender in the State of California. Payment to Lender by Borrower of the Secured Obligations is due in the State of California. This Agreement, the Notes and the other Loan Documents shall be governed by, and construed and enforced in accordance with, the laws of the State of California, excluding conflict of laws principles that would cause the application of laws of any other jurisdiction.

11.9 Consent to Jurisdiction and Venue. All judicial proceedings (to the extent that the reference requirement of Section 11.10 is not applicable) arising in or under or related to this Agreement, the Notes or any of the other Loan Documents may be brought in any state or federal court located in the State of California. By execution and delivery of this Agreement, each party hereto generally and unconditionally: (a) consents to nonexclusive personal jurisdiction in Santa Clara County, State of California; (b) waives any objection as to jurisdiction or venue in Santa Clara County, State of California; (c) agrees not to assert any defense based on lack of jurisdiction or venue in the aforesaid courts; and (d) irrevocably agrees to be bound by any judgment rendered thereby in connection with this Agreement, the Notes or the other Loan Documents. Service of process on any party hereto in any action arising out of or relating to this Agreement shall be effective if given in accordance with the requirements for notice set forth in Section 11.2, and shall be deemed effective and received as set forth in Section 11.2. Nothing herein shall affect the right to serve process in any other manner permitted by law or shall limit the right of either party to bring proceedings in the courts of any other jurisdiction.

11.10 Mutual Waiver of Jury Trial / Judicial Reference.

(a) Because disputes arising in connection with complex financial transactions are most quickly and economically resolved by an experienced and expert person and the parties wish applicable state and federal laws to apply (rather than arbitration rules), the parties desire that their disputes be resolved by a judge applying such applicable laws. EACH OF BORROWER AND LENDER SPECIFICALLY WAIVES ANY RIGHT IT MAY HAVE TO TRIAL BY JURY OF ANY CAUSE OF ACTION, CLAIM, CROSS-CLAIM, COUNTERCLAIM, THIRD PARTY CLAIM OR ANY OTHER CLAIM (COLLECTIVELY, "CLAIMS") ASSERTED BY BORROWER AGAINST LENDER OR ITS ASSIGNEE OR BY LENDER OR ITS ASSIGNEE AGAINST BORROWER. This waiver extends to all such Claims, including Claims that involve Persons other than

Borrower and Lender; Claims that arise out of or are in any way connected to the relationship between Borrower and Lender; and any Claims for damages, breach of contract, tort, specific performance, or any equitable or legal relief of any kind, arising out of this Agreement, any other Loan Document.

(b) If the waiver of jury trial set forth in Section 11.10(a) is ineffective or unenforceable, the parties agree that all Claims shall be resolved by reference to a private judge sitting without a jury, pursuant to Code of Civil Procedure Section 638, before a mutually acceptable referee or, if the parties cannot agree, a referee selected by the Presiding Judge of the Santa Clara County, California. Such proceeding shall be conducted in Santa Clara County, California, with California rules of evidence and discovery applicable to such proceeding.

(c) In the event Claims are to be resolved by judicial reference, either party may seek from a court identified in Section 11.9, any prejudgment order, writ or other relief and have such prejudgment order, writ or other relief enforced to the fullest extent permitted by law notwithstanding that all Claims are otherwise subject to resolution by judicial reference.

11.11 Professional Fees. Borrower promises to pay Lender's fees and expenses necessary to finalize the loan documentation, including but not limited to reasonable attorneys fees, UCC searches, filing costs, and other miscellaneous expenses. In addition, Borrower promises to pay any and all reasonable attorneys' and other professionals' fees and expenses (including fees and expenses of in-house counsel) incurred by Lender after the Closing Date in connection with or related to: (a) the Loan; (b) the administration, collection, or enforcement of the Loan; (c) the amendment or modification of the Loan Documents; (d) any waiver, consent, release, or termination under the Loan Documents; (e) the protection, preservation, sale, lease, liquidation, or disposition of Collateral or the exercise of remedies with respect to the Collateral; (f) any legal, litigation, administrative, arbitration, or out of court proceeding in connection with or related to Borrower or the Collateral, and any appeal or review thereof; and (g) any bankruptcy, restructuring, reorganization, assignment for the benefit of creditors, workout, foreclosure, or other action related to Borrower, the Collateral, the Loan Documents, including representing Lender in any adversary proceeding or contested matter commenced or continued by or on behalf of Borrower's estate, and any appeal or review thereof.

11.12 Confidentiality. Lender acknowledges that certain items of Collateral and information provided to Lender by Borrower are confidential and proprietary information of Borrower, if and to the extent such information either (x) is marked as confidential by Borrower at the time of disclosure, or (y) should reasonably be understood to be confidential (the "Confidential Information"). Accordingly, Lender agrees that any Confidential Information it may obtain in the course of acquiring, administering, or perfecting Lender's security interest in the Collateral shall not be disclosed to any other person or entity in any manner whatsoever, in whole or in part, without the prior written consent of Borrower, except that Lender may disclose any such information: (a) to its own directors, officers, employees, accountants, counsel and other professional advisors and to

its affiliates if Lender in its sole discretion determines that any such party should have access to such information in connection with such party's responsibilities in connection with the Loan or this Agreement and, provided that such recipient of such Confidential Information either (i) agrees to be bound by the confidentiality provisions of this paragraph or (ii) is otherwise subject to confidentiality restrictions that reasonably protect against the disclosure of Confidential Information; (b) if such information is otherwise generally available to the public through no fault of Lender; (c) if required or appropriate in any report, statement or testimony submitted to any governmental authority having or claiming to have jurisdiction over Lender; (d) if required or appropriate in response to any summons or subpoena or in connection with any litigation, to the extent permitted or deemed advisable by Lender's counsel; (e) to comply with any legal requirement or law applicable to Lender; (f) to the extent reasonably necessary in connection with the exercise of any right or remedy under any Loan Document, including Lender's sale, lease, or other disposition of Collateral after default; (g) to any participant or assignee of Lender or any prospective participant or assignee; provided, that such participant or assignee or prospective participant or assignee agrees in writing to be bound by this Section prior to disclosure; or (h) otherwise with the prior consent of Borrower; provided, that any disclosure made in violation of this Agreement shall not affect the obligations of Borrower or any of its affiliates or any guarantor under this Agreement or the other Loan Documents.

11.13 Assignment of Rights. Borrower acknowledges and understands that Lender may sell and assign all or part of its interest hereunder and under the Note(s) and Loan Documents to any person or entity (an "Assignee"). After such assignment the term "Lender" as used in the Loan Documents shall mean and include such Assignee, and such Assignee shall be vested with all rights, powers and remedies of Lender hereunder with respect to the interest so assigned; but with respect to any such interest not so transferred, Lender shall retain all rights, powers and remedies hereby given. No such assignment by Lender shall relieve Borrower of any of its obligations hereunder. Lender agrees that in the event of any transfer by it of the Note(s), it will endorse thereon a notation as to the portion of the principal of the Note(s), which shall have been paid at the time of such transfer and as to the date to which interest shall have been last paid thereon.

11.14 Revival of Secured Obligations. This Agreement and the Loan Documents shall remain in full force and effect and continue to be effective if any petition is filed by or against Borrower for liquidation or reorganization, if Borrower becomes insolvent or makes an assignment for the benefit of creditors, if a receiver or trustee is appointed for all or any significant part of Borrower's assets, or if any payment or transfer of Collateral is recovered from Lender. The Loan Documents and the Secured Obligations and Collateral security shall continue to be effective, or shall be revived or reinstated, as the case may be, if at any time payment and performance of the Secured Obligations or any transfer of Collateral to Lender, or any part thereof is rescinded, avoided or avoidable, reduced in amount, or must otherwise be restored or returned by, or is recovered from, Lender or by any obligee of the Secured Obligations, whether as a "voidable preference," "fraudulent conveyance," or otherwise, all as though such payment, performance, or transfer of Collateral had not been made. In the event that any payment, or any part thereof, is rescinded, reduced, avoided, avoidable, restored, returned, or recovered, the Loan

Documents and the Secured Obligations shall be deemed, without any further action or documentation, to have been revived and reinstated except to the extent of the full, final, and indefeasible payment to Lender in Cash.

11.15 Counterparts. This Agreement and any amendments, waivers, consents or supplements hereto may be executed in any number of counterparts, and by different parties hereto in separate counterparts, each of which when so delivered shall be deemed an original, but all of which counterparts shall constitute but one and the same instrument.

11.16 No Third Party Beneficiaries. No provisions of the Loan Documents are intended, nor will be interpreted, to provide or create any third-party beneficiary rights or any other rights of any kind in any person other than Lender and Borrower unless specifically provided otherwise herein, and, except as otherwise so provided, all provisions of the Loan Documents will be personal and solely between the Lender and the Borrower.

11.17 Publicity. Lender may use Borrower's name and logo, and include a brief description of the relationship between Borrower and Lender, in Lender's marketing materials.

11.18 Joint and Several Liability. Each of Parent and the Joined Subsidiaries is accepting joint and several liability hereunder and under the other Loan Documents in consideration of the financial accommodations to be provided by Lender under this Agreement, for the mutual benefit, directly and indirectly, of each of Parent and the Joined Subsidiaries and in consideration of their undertakings to accept joint and several liability for the Secured Obligations. Each of Parent and the Joined Subsidiaries, jointly and severally, hereby irrevocably, absolutely and unconditionally accepts, not merely as a surety but also as a co-debtor, joint and several liability with respect to the payment and performance of all of the Secured Obligations (including, without limitation, any Secured Obligations arising under this [Section 11.18](#)), it being the intention of Parent and the Joined Subsidiaries that all the Secured Obligations shall be the joint and several obligations of Parent and the Joined Subsidiaries without preferences or distinction among them. If and to the extent that any of Parent or the Joined Subsidiaries shall fail to make any payment with respect to any of the Secured Obligations as and when due or to perform any of the Secured Obligations in accordance with the terms thereof, then in each such event, the other Persons composing Borrower will make such payment with respect to, or perform, such Secured Obligation. Each of Parent and the Joined Subsidiaries hereby agrees that it will not enforce any of its rights of contribution or subrogation against any other Persons composing Borrower with respect to any liability incurred by it hereunder or under any of the other Loan Documents, any payments made by it to Lender with respect to any of the Secured Obligations or any collateral security therefor until such time as all of the Secured Obligations have been paid in full in cash. Any claim which any of Parent or the Joined Subsidiaries may have against any other Persons composing Borrower with respect to any payments to Lender hereunder or under any other Loan Documents are hereby expressly made subordinate and junior in right of payment, without limitation as to any increases in the Secured Obligations arising hereunder or thereunder, to the prior payment in full in cash of the Secured Obligations and, in the event of any insolvency, bankruptcy,

receivership, liquidation, reorganization or other similar proceeding under the laws of any jurisdiction relating to any of Parent or the Joined Subsidiaries, their respective debt or assets, whether voluntary or involuntary, all such Secured Obligations shall be paid in full in cash before any payment or distribution of any character, whether in cash, securities or other property, shall be made to any other Persons composing Borrower therefor.

11.19 Administrative Borrower. Each of the Joined Subsidiaries irrevocably appoints Parent as the borrowing agent and attorney-in-fact for all Persons composing Borrower which appointment shall remain in full force and effect unless and until Lender shall have received prior written notice signed by each of the Joined Subsidiaries that such appointment has been revoked and that another Person has been so appointed.

(SIGNATURES TO FOLLOW)

IN WITNESS WHEREOF, Borrower and Lender have duly executed and delivered this Loan and Security Agreement as of the day and year first above written.

BORROWER:

ENPHASE ENERGY, INC.,
a Delaware corporation

By: /s/ Sanjeev Kumar
Name: Sanjeev Kumar
Title: Chief Financial Officer

Accepted in Palo Alto, California:

LENDER:

**HERCULES TECHNOLOGY
GROWTH CAPITAL, INC.,**
a Maryland corporation

By: /s/ K. Nicholas Martitsch
Name: K. Nicholas Martitsch
Its: Associate General Counsel

EXHIBIT B

SECURED TERM PROMISSORY NOTE

\$[],000,000

Advance Date: [][], 20[]

Maturity Date: July 1, 2014

FOR VALUE RECEIVED, ENPHASE ENERGY, INC., a Delaware corporation (“Parent”) and each of Parent’s other subsidiaries joined to the Loan Agreement (“Joined Subsidiaries”, together with Parent hereinafter collectively referred to as the “Borrower”) hereby promise to pay to the order of Hercules Technology Growth Capital, Inc., a Maryland corporation or the holder of this Note (the “Lender”) at 400 Hamilton Avenue, Suite 310, Palo Alto, CA 94301 or such other place of payment as the holder of this Secured Term Promissory Note (this “Promissory Note”) may specify from time to time in writing, in lawful money of the United States of America, the principal amount of [] Million Dollars (\$[],000,000) or such other principal amount as Lender has advanced to Borrower, together with interest at a floating rate equal to the Interest Rate (as defined in the Credit Agreement (as defined below)) per annum based upon a year consisting of 360 days, with interest computed daily based on the actual number of days in each month.

This Promissory Note is the Note referred to in, and is executed and delivered in connection with, that certain Loan and Security Agreement dated June 13, 2011, by and between Borrower and Lender (as the same may from time to time be amended, modified or supplemented in accordance with its terms, the “Loan Agreement”), and is entitled to the benefit and security of the Loan Agreement and the other Loan Documents (as defined in the Loan Agreement), to which reference is made for a statement of all of the terms and conditions thereof. All payments shall be made in accordance with the Loan Agreement. All terms defined in the Loan Agreement shall have the same definitions when used herein, unless otherwise defined herein. An Event of Default under the Loan Agreement shall constitute a default under this Promissory Note.

Borrower waives presentment and demand for payment, notice of dishonor, protest and notice of protest under the UCC or any applicable law. Borrower agrees to make all payments under this Promissory Note without setoff, recoupment or deduction and regardless of any counterclaim or defense. This Promissory Note has been negotiated and delivered to Lender and is payable in the State of California. This Promissory Note shall be governed by and construed and enforced in accordance with, the laws of the State of California, excluding any conflicts of law rules or principles that would cause the application of the laws of any other jurisdiction.

[Remainder of page intentionally left blank; signature page follows]

BORROWER FOR ITSELF AND
ON BEHALF OF ITS SUBSIDIARIES:

ENPHASE ENERGY, INC.

Signature: _____

Print Name: _____

Title: _____

Table of Exhibits and Schedules

Exhibit A:	Advance Request Attachment to Advance Request
Exhibit B:	Term Note
Exhibit C:	Name, Locations, and Other Information for Borrower
Exhibit D:	Compliance Certificate
Exhibit E:	Joinder Agreement
Exhibit F:	ACH Debit Authorization Agreement
Schedule 1	Subsidiaries
Schedule 1A	Existing Permitted Indebtedness
Schedule 1B	Existing Permitted Investments
Schedule 1C	Existing Permitted Liens
Schedule 5.3	Consents, Etc.
Schedule 5.5	Actions Before Governmental Authorities
Schedule 5.8	Tax Matters
Schedule 5.9	Intellectual Property Claims
Schedule 5.10	Intellectual Property
Schedule 5.14	Capitalization

EXHIBIT A
ADVANCE REQUEST

To: Lender:

Date: [] [], 2011

Hercules Technology Growth Capital, Inc.
400 Hamilton Avenue, Suite 310
Palo Alto, CA 94301
Facsimile:
Attn:

Enphase Energy, Inc. ("Borrower") hereby requests from Hercules Technology Growth Capital, Inc. ("Lender") an Advance in the amount of [] Dollars (\$[],000,000) on [] [], 2011 (the "Advance Date") pursuant to the Loan and Security Agreement between Borrower and Lender (the "Agreement"). Capitalized words and other terms used but not otherwise defined herein are used with the same meanings as defined in the Agreement.

Please:

(a) Issue a check payable to Borrower _____

or

(b) Wire Funds to Borrower's account _____

Bank: _____

Address: _____

ABA Number: _____

Account Number: _____

Account Name: _____

Borrower represents that the conditions precedent to the Advance set forth in the Agreement are satisfied and shall be satisfied upon the making of such Advance, including but not limited to: (i) that no event that has had or could reasonably be expected to have a Material Adverse Effect has occurred and is continuing; (ii) that the representations and warranties set forth in the Agreement and in the Warrant are and shall be true and correct in all material respects on and as of the Advance Date with the same effect as though made on and as of such date, except to the extent such representations and warranties expressly relate to an earlier date; (iii) that Borrower is in compliance with all the terms and provisions set forth in each Loan Document on its part to be observed or performed; and (iv) that as of the Advance Date, no fact or condition exists that would (or would, with the passage of time, the giving of notice, or both) constitute an Event of Default under the Loan Documents. Borrower understands and acknowledges that Lender has the right to review the financial information supporting this representation and, based upon such review in its sole discretion, Lender may decline to fund the requested Advance.

Borrower hereby represents that Borrower's corporate status and locations have not changed since the date of the Agreement or, if the Attachment to this Advance Request is completed, are as set forth in the Attachment to this Advance Request.

To secure the prompt payment by Borrower of all amounts from time to time outstanding under the Agreement, and the performance by Borrower of all the terms contained in the Agreement, Borrower grants Lender, a first priority security interest in each item of equipment and other property described in Annex A hereto, which equipment and other property shall be deemed to be additional Financed Equipment and Collateral. The Agreement is hereby incorporated by reference herein and is hereby ratified, approved and confirmed.

Borrower agrees to notify Lender promptly before the funding of the Loan if any of the matters which have been represented above shall not be true and correct on the Borrowing Date and if Lender has received no such notice before the Advance Date then the statements set forth above shall be deemed to have been made and shall be deemed to be true and correct as of the Advance Date.

[Remainder of page intentionally left blank; signature page follows]

Executed as of _____, 201[].

BORROWER:

ENPHASE ENERGY, INC.

SIGNATURE: _____

TITLE: _____

PRINT NAME: _____

ATTACHMENT TO ADVANCE REQUEST

Dated: _____

Borrower hereby represents and warrants to Lender that Borrower's current name and organizational status is as follows:

Name: Enphase Energy, Inc.

Type of organization: Corporation

State of organization: Delaware

Organization file number: 4118583

Borrower hereby represents and warrants to Lender that the street addresses, cities, states and postal codes of its current locations are as follows:

Annex A to Advance Request

The Financed Equipment being financed with the Advance which this Advance Request is being executed is listed below (such list may be re-formatted as a spreadsheet). Upon the funding of such Advance, this schedule and the property described below automatically shall be deemed to be a part of the Collateral.

FINANCED EQUIPMENT

Description of Equipment

Make

Serial # (if applicable)

Quantity

PO #

Invoice Date

Invoice #

Cost

Location

Title holder

TOTAL COST:

EXHIBIT B

SECURED TERM PROMISSORY NOTE

\$[] ,000,000

Advance Date: [] [] , 20[]

Maturity Date: July 1, 2014

FOR VALUE RECEIVED, ENPHASE ENERGY, INC., a Delaware corporation (“Parent”) and each of Parent’s other subsidiaries joined to the Loan Agreement (“Joined Subsidiaries”, together with Parent hereinafter collectively referred to as the “Borrower”) hereby promise to pay to the order of Hercules Technology Growth Capital, Inc., a Maryland corporation or the holder of this Note (the “Lender”) at 400 Hamilton Avenue, Suite 310, Palo Alto, CA 94301 or such other place of payment as the holder of this Secured Term Promissory Note (this “Promissory Note”) may specify from time to time in writing, in lawful money of the United States of America, the principal amount of [] Million Dollars (\$[] ,000,000) or such other principal amount as Lender has advanced to Borrower, together with interest at a floating rate equal to the Interest Rate (as defined in the Credit Agreement (as defined below)) per annum based upon a year consisting of 360 days, with interest computed daily based on the actual number of days in each month.

This Promissory Note is the Note referred to in, and is executed and delivered in connection with, that certain Loan and Security Agreement dated June 13, 2011, by and between Borrower and Lender (as the same may from time to time be amended, modified or supplemented in accordance with its terms, the “Loan Agreement”), and is entitled to the benefit and security of the Loan Agreement and the other Loan Documents (as defined in the Loan Agreement), to which reference is made for a statement of all of the terms and conditions thereof. All payments shall be made in accordance with the Loan Agreement. All terms defined in the Loan Agreement shall have the same definitions when used herein, unless otherwise defined herein. An Event of Default under the Loan Agreement shall constitute a default under this Promissory Note.

Borrower waives presentment and demand for payment, notice of dishonor, protest and notice of protest under the UCC or any applicable law. Borrower agrees to make all payments under this Promissory Note without setoff, recoupment or deduction and regardless of any counterclaim or defense. This Promissory Note has been negotiated and delivered to Lender and is payable in the State of California. This Promissory Note shall be governed by and construed and enforced in accordance with, the laws of the State of California, excluding any conflicts of law rules or principles that would cause the application of the laws of any other jurisdiction.

[Remainder of page intentionally left blank; signature page follows]

BORROWER FOR ITSELF AND
ON BEHALF OF ITS SUBSIDIARIES:

ENPHASE ENERGY, INC.

Signature: _____

Print Name: _____

Title: _____

EXHIBIT C

NAME, LOCATIONS, AND OTHER INFORMATION FOR BORROWER

1. Borrower represents and warrants to Lender that Borrower's current name and organizational status as of the Closing Date is as follows:

Name: Enphase Energy, Inc.
Type of organization: Corporation
State of organization: Delaware
Organization file number: 4118583

Borrower's fiscal year ends on December 31

Borrower's federal employer tax identification number is: 20-4645388

2. Borrower represents and warrants to Lender that for five (5) years prior to the Closing Date, Borrower did not do business under any other name or organization or form except the following:

Name: PVI Solutions, Inc.
Used during dates of: March 2006 - July 2007
Type of organization: Corporation
State of organization: Delaware
Organization file number: 4118583

3. Borrower represents and warrants to Lender that its chief executive office is located at 201 First Street, Suite 100, Petaluma, CA 94952.

EXHIBIT D

COMPLIANCE CERTIFICATE

Hercules Technology Growth Capital, Inc.
400 Hamilton Avenue, Suite 310
Palo Alto, CA 94301

Reference is made to that certain Loan and Security Agreement dated June 13, 2011 and all ancillary documents entered into in connection with such Loan and Security Agreement all as may be amended from time to time, (hereinafter referred to collectively as the "Loan Agreement") between Hercules Technology Growth Capital, Inc. ("Hercules") as Lender and Enphase Energy, Inc. (with each of the Joined Subsidiaries, the "Company") as Borrower. All capitalized terms not defined herein shall have the same meaning as defined in the Loan Agreement.

The undersigned is an Officer of the Company, knowledgeable of all Company financial matters, and is authorized to provide certification of information regarding the Company; hereby certifies that in accordance with the terms and conditions of the Loan Agreement, the Company is in compliance for the period ending _____ of all covenants, conditions and terms and hereby reaffirms that all representations and warranties contained therein are true and correct on and as of the date of this Compliance Certificate with the same effect as though made on and as of such date, except to the extent such representations and warranties expressly relate to an earlier date, after giving effect in all cases to any standard(s) of materiality contained in the Loan Agreement as to such representations and warranties. Attached are the required documents supporting the above certification. The undersigned further certifies that these are prepared in accordance with GAAP (except for the absence of footnotes with respect to unaudited financial statement and subject to normal year end adjustments) and are consistent from one period to the next except as explained below.

REPORTING REQUIREMENT	REQUIRED	CHECK IF ATTACHED
Interim Financial Statements	Monthly within 30 days (45 days for the last month in any fiscal quarter)	
Interim Financial Statements	Quarterly within 45 days	
Audited Financial Statements	FYE within 180 days	

Very Truly Yours,

ENPHASE ENERGY, INC.,
as Borrower

Signature: _____
Print Name: _____
Title: _____

EXHIBIT E

FORM OF JOINDER AGREEMENT

This Joinder Agreement (the "Joinder Agreement") is made and dated as of [], 20[], and is entered into by and between _____, a _____ corporation ("Subsidiary"), and HERCULES TECHNOLOGY GROWTH CAPITAL, INC., a Maryland corporation, as a Lender.

RECITALS

A. Subsidiary's affiliate, Enphase Energy, Inc. ("Company") has entered into that certain Loan and Security Agreement dated June 13, 2011, with Lender, as such agreement may be amended (the "Loan Agreement"), together with the other agreements executed and delivered in connection therewith;

B. Subsidiary acknowledges and agrees that it will benefit both directly and indirectly from Company's execution of the Loan Agreement and the other agreements executed and delivered in connection therewith;

AGREEMENT

NOW THEREFORE, Subsidiary and Lender agree as follows:

1. The recitals set forth above are incorporated into and made part of this Joinder Agreement. Capitalized terms not defined herein shall have the meaning provided in the Loan Agreement.
2. By signing this Joinder Agreement, Subsidiary shall be bound by the terms and conditions of the Loan Agreement the same as if it were the Borrower (as defined in the Loan Agreement) under the Loan Agreement, mutatis mutandis, provided however, that Lender shall have no duties, responsibilities or obligations to Subsidiary arising under or related to the Loan Agreement or the other agreements executed and delivered in connection therewith. Rather, to the extent that Lender has any duties, responsibilities or obligations arising under or related to the Loan Agreement or the other agreements executed and delivered in connection therewith, those duties, responsibilities or obligations shall flow only to Company and not to Subsidiary or any other person or entity. By way of example (and not an exclusive list): (a) Lender's providing notice to Company in accordance with the Loan Agreement or as otherwise agreed between Company and Lender shall be deemed provided to Subsidiary; (b) a Lender's providing an Advance to Company shall be deemed an Advance to Subsidiary; and (c) Subsidiary shall have no right to request an Advance or make any other demand on Lender.

[REMAINDER OF PAGE INTENTIONALLY LEFT BLANK]

SUBSIDIARY:

By:
Name:
Title:

Address:

Telephone: _____

Facsimile: _____

HERCULES TECHNOLOGY GROWTH
CAPITAL, INC.,
a Maryland corporation

By: _____

Name: K. Nicholas Martitsch

Its: Associate General Counsel

Address:
400 Hamilton Ave., Suite 310
Palo Alto, CA 94301
Facsimile:
Telephone:

EXHIBIT F

ACH DEBIT AUTHORIZATION AGREEMENT

Hercules Technology Growth Capital, Inc.
400 Hamilton Avenue, Suite 310
Palo Alto, CA 94301

Re: Loan and Security Agreement dated June 13, 2011 between Enphase Energy, Inc.
(the "Borrower") and Hercules Technology Growth Capital, Inc. ("Company") (the "Agreement")

In connection with the above referenced Agreement, the Borrower hereby authorizes the Company to initiate debit entries for the periodic payments due under the Agreement to the Borrower's account indicated below. The Borrower authorizes the depository institution named below to debit to such account.

DEPOSITORY NAME	BRANCH
CITY	STATE AND ZIP CODE
TRANSIT/ABA NUMBER	ACCOUNT NUMBER

This authority will remain in full force and effect so long as any amounts are due under the Agreement.

(Borrower)(Please Print)

By: _____

Date: _____

[Signature Page to ACH Debit Authorization Agreement]

**AMENDMENT NO. 1
TO
LOAN AND SECURITY AGREEMENT**

THIS AMENDMENT NO. 1 TO LOAN AND SECURITY AGREEMENT (this “**Amendment**”) is entered into this 20th day of June, 2011 by and between **ENPHASE ENERGY, INC.**, a Delaware corporation (“**Parent**”), and each of Parent’s subsidiaries joined thereto (the “**Joined Subsidiaries**”; the **Joined Subsidiaries** and **Parent** are hereinafter referred to collectively as the “**Borrower**”), and **HERCULES TECHNOLOGY GROWTH CAPITAL, INC.**, a Maryland corporation (the “**Lender**”). Capitalized terms used herein without definition shall have the same meanings given them in the Loan Agreement (as defined below).

RECITALS

A. The Borrower and the Lender have entered into that certain Loan and Security Agreement dated as of June 13, 2011 (as amended, restated, supplemented or otherwise modified from time to time, the “**Loan Agreement**”), pursuant to which the Lender has agreed to extend and make available to the Borrower certain extensions of credit.

B. The Borrower and the Lender have agreed to amend the Loan Agreement upon the terms and conditions more fully set forth herein.

AGREEMENT

NOW, THEREFORE, in consideration of the foregoing Recitals and intending to be legally bound, the parties hereto agree as follows:

1. AMENDMENTS.

1.1 Section 1.1 (Definitions). Section 1.1 of the Loan Agreement is hereby amended in the following respects:

(a) Section 1.1 of the Loan Agreement is hereby amended by deleting the definition of “Investors’ Subordination Agreement” in its entirety therefrom.

(b) Section 1.1 of the Loan Agreement is hereby amended by inserting the following new definition therein in alphabetical order:

“Convertible Lenders” has the meaning given to it in the definition of “Investors’ Indebtedness”.

“First Amendment Effective Date” means the “Effective Date” as defined in Amendment No. 1 to Loan and Security Agreement, dated as of June 20, 2011, by and between Borrower and Lender.

“KPCB” has the meaning given to it in the definition of “Investors’ Indebtedness”.

“Subordinated Loan Agreement” has the meaning given to it in the definition of “Investors’ Indebtedness”.

(c) Section 1.1 of the Loan Agreement is hereby amended by amending and restating the following definitions in their entirety as follows:

“Investors’ Indebtedness” means the Indebtedness of Borrower in favor of the Investors in an original aggregate principal amount not to exceed \$50,000,000 pursuant to that certain Subordinated Convertible Loan Facility and Security Agreement, dated as of June 14, 2011 (together, with the other ancillary and collateral security documents entered into by Borrower in connection therewith, the “Subordinated Loan Agreement”), by and among Borrower, the lenders from time to time parties thereto or other Persons who from time to time may become parties thereto (collectively, the “Convertible Lenders”), and KPCB Holdings, Inc., as nominee, in its capacity as agent for itself as a Convertible Lender and the other Convertible Lenders (in such capacity, “KPCB”), as the same may be amended, restated, supplemented or otherwise modified from time to time; provided, that, prior to the indefeasible payment in full of all Secured Obligations (in an aggregate principal amount not to exceed \$5,000,000), any amendment, restatement, refinancing, supplement or other modification of the Subordinated Loan Agreement that (i) shortens the fixed date component of the Maturity Date definition in the Subordinated Loan Agreement from three (3) years after the effective date of the Subordinated Loan Agreement, or (ii) creates or provides for the scheduling of regular cash payments of principal or interest or requires any prepayment of the obligations of Borrower under the Subordinated Loan Agreement, other than payment in full upon the Maturity Date (as such term is defined in the Subordinated Loan Agreement) (for the avoidance of doubt, the foregoing shall not affect KPCB’s ability to effect remedies, in each case, as provided for in the Subordinated Loan Agreement as in effect on the First Amendment Effective Date), in each case, shall be approved in advance in writing by Lender in its sole discretion.

“Maturity Date” means June 1, 2014.

“Release Letters” means letters from each of the Incumbent Lenders and KPCB, in its capacity as agent for the Convertible Lenders, pursuant to which each of the Incumbent Lenders and KPCB, on behalf of the Convertible Lenders, agrees to release any interest in the Financed Equipment, in each case, in form and substance acceptable to Lender.

1.2 Section 2.1 (Loan). Section 2.1(d) of the Loan Agreement is hereby amended by replacing the number “25” with the number “24” in the fourth line of such section.

1.3 Section 7.5 (Indebtedness). Section 7.5 of the Loan Agreement is hereby amended by replacing the phrase “subject to the Investors Subordination Agreement” with the following phrase: “so long as any such prepayment of the Investors’ Indebtedness is expressly required by the terms and provisions of the Subordinated Loan Agreement as in effect on the First Amendment Effective Date or as such agreement is amended in accordance with this Agreement”.

1.4 Exhibit B (Form of Secured Term Promissory Note). Exhibit B attached to the Loan Agreement is hereby amended by replacing the date of “July 1, 2014”, which appears immediately following the phrase “Maturity Date:” in the upper right-hand corner of such Exhibit, with the date of “June 1, 2014”.

2. BORROWER’S REPRESENTATIONS AND WARRANTIES. The Borrower represents and warrants that:

(a) immediately upon giving effect to this Amendment (i) the representations and warranties contained in the Loan Documents are true, accurate and complete in all material respects as of the date hereof (except to the extent such representations and warranties relate to an earlier date, in which case they are true and correct as of such date), and (ii) no Event of Default has occurred and is continuing;

(b) The Borrower has the corporate power and authority to execute and deliver this Amendment and to perform its obligations under the Loan Agreement, as amended by this Amendment;

(c) the certificate or articles of incorporation, bylaws and other organizational documents of the Borrower delivered to the Lender on the Closing Date remain true, accurate and complete and have not been amended, restated, supplemented or otherwise modified and continue to be in full force and effect;

(d) the execution and delivery by the Borrower of this Amendment and the performance by the Borrower of its obligations under the Loan Agreement, as amended by this Amendment, have been duly authorized by all necessary corporate action on the part of the Borrower;

(e) this Amendment has been duly executed and delivered by the Borrower and is the binding obligation of the Borrower, enforceable against it in accordance with its terms, except as such enforceability may be limited by bankruptcy, insolvency, reorganization, liquidation, moratorium or other similar laws of general application and equitable principles relating to or affecting creditors’ rights generally; and

(f) as of the date hereof, the Borrower has no defenses against the obligations to pay any amounts under the Obligations. The Borrower acknowledges that the Lender has acted in good faith and has conducted in a commercially reasonable manner its relationships with the Borrower in connection with this Amendment and in connection with the Loan Documents.

The Borrower understands and acknowledges that the Lender is entering into this Amendment in reliance upon, and in partial consideration for, the above representations and warranties, and agrees that such reliance is reasonable and appropriate.

3. LIMITATION. The amendments set forth in this Amendment shall be limited precisely as written and shall not be deemed (a) to be a waiver or modification of any other term or condition of the Loan Agreement or of any other instrument or agreement referred to therein or to prejudice any right or remedy which the Lender may now have or may have in the future under or in connection with the Loan Agreement or any instrument or agreement referred to

therein; or (b) to be a consent to any future amendment or modification or waiver to any instrument or agreement the execution and delivery of which is consented to hereby, or to any waiver of any of the provisions thereof. Except as expressly amended hereby, the Loan Agreement shall continue in full force and effect.

4. EFFECTIVENESS. This Amendment shall become effective upon the satisfaction of all of the following conditions precedent in form and substance satisfactory to the Lender (the “**Effective Date**”):

4.1 Amendment. The Lender shall have received duly executed counterparts of this Amendment signed by the parties hereto.

4.2 Release Letter. The Lender shall have received a duly executed Release Letter from KPCB signed by the parties thereto.

5. EXPENSES. The Borrower agrees to pay the Lender’s costs and expenses (including the fees and expenses of the Lender’s counsel, advisors and consultants) accrued and incurred in connection with the transactions contemplated by this Amendment in an amount not to exceed \$7,500 without Borrower’s consent, and all other Lender expenses (including the fees and expenses of Lender’s counsel, advisors and consultants) payable in accordance with Section 11.11 of the Loan Agreement.

6. COUNTERPARTS. This Amendment may be signed originally or by facsimile or other means of electronic transmission in any number of counterparts, and by different parties hereto in separate counterparts, with the same effect as if the signatures to each such counterpart were upon a single instrument. All counterparts shall be deemed an original of this Amendment.

7. INTEGRATION. This Amendment and any documents executed in connection herewith or pursuant hereto contain the entire agreement between the parties with respect to the subject matter hereof and supersede all prior agreements, understandings, offers and negotiations, oral or written, with respect thereto and no extrinsic evidence whatsoever may be introduced in any judicial or arbitration proceeding, if any, involving this Amendment; except that any financing statements or other agreements or instruments filed by the Lender with respect to the Borrower shall remain in full force and effect.

8. GOVERNING LAW; VENUE. THIS AMENDMENT SHALL BE GOVERNED BY AND SHALL BE CONSTRUED AND ENFORCED IN ACCORDANCE WITH THE LAWS OF THE STATE OF CALIFORNIA. The Borrower and the Lender each submit to the exclusive jurisdiction of the State and Federal courts in Santa Clara County, California.

[Remainder of page intentionally left blank; signature page follows]

IN WITNESS WHEREOF, the parties have duly authorized and caused this Amendment to be executed as of the date first written above.

BORROWER:

ENPHASE ENERGY, INC.

By: /s/ Sanjeev Kumar
Name: Sanjeev Kumar
Title: CFO

LENDER:

**HERCULES TECHNOLOGY GROWTH
CAPITAL, INC.**

By: _____
Name: K. Nicholas Martitsch
Title: Associate General Counsel

[Signature Page to Amendment No. 1 to Loan and Security Agreement]

IN WITNESS WHEREOF, the parties have duly authorized and caused this Amendment to be executed as of the date first written above.

BORROWER:

ENPHASE ENERGY, INC.

By: _____
Name: _____
Title: _____

LENDER:

**HERCULES TECHNOLOGY GROWTH
CAPITAL, INC.**

By: /s/ K. Nicholas Martitsch _____
Name: K. Nicholas Martitsch
Title: Associate General Counsel

[Signature Page to Amendment No. 1 to Loan and Security Agreement]

CERTAIN CONFIDENTIAL INFORMATION CONTAINED IN THIS DOCUMENT, MARKED BY BRACKETS, HAS BEEN OMITTED AND FILED SEPARATELY WITH THE SECURITIES AND EXCHANGE COMMISSION PURSUANT TO RULE 406 OF THE SECURITIES ACT OF 1933, AS AMENDED. CONFIDENTIAL TREATMENT HAS BEEN REQUESTED WITH RESPECT TO THE OMITTED PORTIONS.

SUBORDINATED CONVERTIBLE LOAN FACILITY

AND

SECURITY AGREEMENT

by and between

KPCB HOLDINGS, INC., AS NOMINEE,
as Agent and Lender,

THE OTHER PARTIES NAMED HEREIN,
each as a Lender,

and

ENPHASE ENERGY, INC.,

as Borrower

This SUBORDINATED CONVERTIBLE LOAN FACILITY AND SECURITY AGREEMENT (this or the "Agreement") is made as of June 14, 2011 (the "Effective Date") by and among Enphase Energy, Inc., a Delaware corporation ("Borrower"), KPCB Holdings, Inc., as nominee, a California corporation ("KPCB"), as a Lender hereunder and in its capacity as Agent on behalf of the Lenders hereunder, and the other Persons named herein or who may become parties hereto (together with KPCB, referred to herein individually as a "Lender" and collectively as the "Lenders"), as Lenders, in accordance with the terms of this Agreement.

A. Borrower has requested that the Lenders provide, and the Lenders wish to provide, convertible secured loans and other financial accommodations to Borrower for working capital and other general corporate purposes on the terms and subject to the conditions set forth in this Agreement.

B. In connection with the Initial Advance (as defined below), Borrower has agreed to issue, and the Lenders have agreed to, at the election of the Lenders, either acquire in connection with the initial Loans hereunder certain warrants to purchase shares of common stock of Borrower in the form attached as Exhibit F (the "Warrants"), or purchase that number of shares of Borrower's common stock, par value \$0.00001 per share (the "Common Stock"), and at the purchase price, as set forth opposite the name of the applicable Lender on Schedule I hereto, as further provided in Section 2.1(d).

NOW, THEREFORE, in consideration of the foregoing and other good and valuable consideration, the receipt and sufficiency of which are hereby acknowledged, the parties hereto hereby agree as follows:

AGREEMENT

1. Definitions and Construction.

1.1 Definitions. As used in this Agreement, the following capitalized terms shall have the following meanings:

"Account Control Agreement" means an agreement acceptable to Agent which perfects via control Agent's security interest in, on behalf of the Lenders, Borrower's deposit accounts and/or accounts holding securities.

"Advance" means any advance of credit by the Lenders to Borrower being provided by the Lenders to Borrower pursuant to this Agreement, and "Advances" means, collectively, all such advances.

"Affiliate" means, with respect to any specified Person, such Person's principal or any other Person who or which, directly or indirectly, controls, is controlled by, or is under common control with such Person or such Person's principal, including, without limitation, any general partner, managing member or partner, officer or director of such Person or such Person's principal or any venture capital fund now or hereafter existing that is controlled by one or more general partners or managing members of, or shares the same management company with, such Person or such Person's principal.

"Agent" means KPCB, not in its individual capacity, but solely in its capacity as administrative agent on behalf of and for the ratable benefit of the Lenders under this Agreement.

“Agreement” has the meaning given such term in the preamble of this Agreement, as amended, amended and restated, modified, joined, supplemented or as otherwise modified from time to time.

“Assignment” has the meaning given such term in Section 12.2 of this Agreement.

“Account” has the meaning given such term in Section 7.13 of this Agreement.

“Borrower” has the meaning given such term in the preamble of this Agreement.

“Business Day” means any day that is not a Saturday, Sunday, or other day on which banking institutions are authorized or required to close in San Francisco, California.

“Change in Control” has the meaning given such term in Section 7.7 of this Agreement.

“Claim” has the meaning given such term in Section 10.3 of this Agreement

“Code” means the Uniform Commercial Code as adopted and in effect in the State of California, as amended from time to time; provided that if by reason of mandatory provisions of law, the creation and/or perfection or the effect of perfection or non-perfection of the security interest in any Collateral is governed by the Uniform Commercial Code as in effect in a jurisdiction other than California, the term “Code” shall also mean the Uniform Commercial Code as in effect from time to time in such jurisdiction for purposes of the provisions hereof relating to such creation, perfection or effect of perfection or non-perfection.

“Collateral” has the meaning given such term in Section 4.1 of this Agreement.

“Commitment Amount(s)” means, with respect to each Lender under this Agreement, the maximum amount such Lender may be obligated to provide hereunder in respect of the funding of Advances set forth in Schedule I to this Agreement, as such schedule may be amended or otherwise modified from time to time. The aggregate Commitment Amount of the Lenders on the Effective Date shall be \$50,000,000.

“Commitment Termination Date” means the earliest to occur of (i) twenty-four (24) months after the Effective Date, (ii) the consummation of a Subsequent Equity Financing, and (iii) the occurrence of the Maturity Date.

“Common Stock” has the meaning given such term in the recitals of this Agreement.

“Contingent Obligation” means, as applied to any Person, any direct or indirect liability, contingent or otherwise, of that Person with respect to (i) any indebtedness, lease, dividend, letter of credit or other obligation of another; (ii) any obligations with respect to undrawn letters of credit, corporate credit cards, or merchant services issued or provided for the account of that Person; and (iii) all obligations arising under any agreement or arrangement designed to protect such Person against fluctuation in interest rates, currency exchange rates or commodity prices; provided, however, that the term “Contingent Obligation” shall not include endorsements for collection or deposit in the ordinary course of business. The amount of any Contingent Obligation shall be deemed to be an amount equal to the stated or determined amount of the primary obligation in respect of which such Contingent Obligation is made or, if not stated or determinable, the maximum reasonably anticipated liability in respect thereof as determined by the Lenders in good faith; provided, however, that such amount shall not in any event exceed the maximum amount of the obligations under the guarantee or other support arrangement.

[***] = CERTAIN INFORMATION ON THIS PAGE HAS BEEN OMITTED AND FILED SEPARATELY WITH THE COMMISSION. CONFIDENTIAL TREATMENT HAS BEEN REQUESTED WITH RESPECT TO THE OMITTED PORTIONS.

“Default” means any event which with the passing of time or the giving of notice or both would become an Event of Default hereunder.

“Default Rate” means the per annum rate of interest equal to five percent (5%) over the applicable Loan Rate, but such rate shall in no event be more than the highest rate permitted by applicable law to be charged on commercial loans in a default situation.

“Disclosure Schedule” means Exhibit A attached hereto.

“Environmental Laws” means all foreign, federal, state or local laws, statutes, common law duties, rules, regulations, ordinances and codes, together with all administrative orders, directed duties, requests, licenses, authorizations and permits of, and agreements with, any Governmental Authorities, in each case relating to environmental, health, safety and land use matters, including the Comprehensive Environmental Response, Compensation and Liability Act of 1980, the Clean Air Act, the Federal Water Pollution Control Act of 1972, the Solid Waste Disposal Act, the Federal Resource Conservation and Recovery Act, the Toxic Substances Control Act and the Emergency Planning and Community Right-to-Know Act.

“Equipment” means all present and future machinery, equipment, tenant improvements, furniture, fixtures, vehicles, tools, parts and attachments in which Borrower has any interest.

“Equity Securities” of any Person means (a) all common stock, preferred stock, participations, shares, partnership interests, membership interests or other equity interests in and of such Person (regardless of how designated and whether or not voting or non-voting) and (b) all warrants, options and other rights to acquire any of the foregoing.

“ERISA” has the meaning given to such term in Section 7.12 of this Agreement.

“Event of Default” has the meaning given to such term in Section 8 of this Agreement.

“Exchange Act” means the Securities and Exchange Act of 1934, as amended, and the rules and regulations promulgated thereunder.

“Foreign Accounts” has the meaning given such term in Section 7.13 of this Agreement.

“French Account” has the meaning given such term in Section 7.13 of this Agreement.

“Funding Certificate” means a certificate executed by a Responsible Officer of Borrower substantially in the form of Exhibit B or such other form as the Agent may agree to accept.

“Funding Date” means any date on which an Advance is made to or on account of Borrower under this Agreement.

“GAAP” means generally accepted accounting principles as in effect in the United States of America from time to time, consistently applied.

“Governmental Authority” means (a) any federal, state, county, municipal or foreign government, or political subdivision thereof, (b) any governmental or quasi-governmental agency, authority, board, bureau, commission, department, instrumentality or public body, (c) any court or administrative tribunal, or (d) with respect to any Person, any arbitration tribunal or other non-governmental authority to whose jurisdiction that Person has consented.

“Gross Profit” means, with respect to any period, the gross profit of Borrower and its Subsidiaries as determined in accordance with GAAP consistently applied and consistent with the methodology reflected in Borrower’s financial statements for the fiscal year ended December 31, 2010 audited by Deloitte & Touche LLP.

“Hazardous Materials” means all those substances which are regulated by, or which may form the basis of liability under, any Environmental Law, including all substances identified under any Environmental Law as a pollutant, contaminant, hazardous waste, hazardous constituent, special waste, hazardous substance, hazardous material, or toxic substance, or petroleum or petroleum derived substance or waste.

“Indebtedness” means (a) all indebtedness for borrowed money or the deferred purchase price of property or services (excluding trade payables aged less than one hundred eighty (180) days), including without limitation reimbursement and other obligations with respect to surety bonds and letters of credit, (b) all obligations evidenced by notes, bonds, debentures or similar instruments, (c) all capital lease obligations and (d) all Contingent Obligations.

“Indemnified Person” has the meaning given such term in Section 10.3 of this Agreement.

“Intellectual Property” means all of Borrower’s right, title and interest in and to patents, patent rights (and applications and registrations therefor and divisions, continuations, renewals, reissues, extensions and continuations-in-part of the same), trademarks and service marks (and applications and registrations therefor and the goodwill associated therewith), inventions, copyrights (including applications and registrations therefor and like protections in each work or authorship and derivative work thereof), mask works (and applications and registrations therefor), trade names, trade styles, software and computer programs, source code, object code, trade secrets, methods, processes, know how, drawings, specifications, descriptions, and all memoranda, notes, and records with respect to any research and development, all whether now owned or subsequently acquired or developed by Borrower and all licenses to use the foregoing, whether in tangible or intangible form or contained on magnetic media readable by machine together with all such magnetic media (but not including embedded computer programs and supporting information included within the definition of “goods” under the Code).

“Interest Payment Date” means the first day of each month commencing on July 1, 2011, provided that if any such day is not a Business Day, such Interest Payment Date shall be extended to the next succeeding Business Day and interest shall accrue for each day of such extension.

“Inventory” means all inventory in which Borrower has or acquires any interest, including work in process and finished products intended for sale or lease or to be furnished under a contract of service, of every kind and description now or at any time hereafter owned by or in the custody or possession, actual or constructive, of Borrower, including such inventory as is temporarily out of its custody or possession or in transit and including any returns upon any accounts or other proceeds, including insurance proceeds, resulting from the sale or disposition of any of the foregoing and any documents of title representing any of the above, and Borrower’s books relating to any of the foregoing.

“Investment” means the purchase or acquisition of any capital stock, equity interest, or any obligations or other securities of, or any interest in, any Person, or the extension of any advance, loan, extension of credit (excluding inter-company trade payables aged less than one hundred eighty (180) days) or capital contribution to, or any other investment in, or deposit with, any Person.

“IPO” means Borrower’s first underwritten public offering of its common stock under the Securities Act.

“Initial Advance” has the meaning given such term in Section 2.1(a) of this Agreement.

“Italian Account” has the meaning given such term in Section 7.13 of this Agreement.

“Landlord Agreement” means an agreement substantially in the form provided by Lender to Borrower or such other form as Lender may agree to accept.

“Lender” means each of the Persons named in Schedule I to this Agreement, as such schedule may be amended or otherwise modified from time to time.

“Lenders’ Expenses” means all reasonable costs or expenses (including reasonable attorneys’ fees and expenses) incurred by Agent in connection with the preparation, negotiation, documentation, administration and funding of the Loan Documents; and the Agent’s and/or Lenders’ reasonable attorneys’ fees, costs and expenses incurred in amending, modifying, enforcing or defending the Loan Documents (including fees and expenses of appeal or review), including the exercise of any rights or remedies afforded hereunder or under applicable law, whether or not suit is brought, whether before or after bankruptcy or insolvency, including without limitation all fees and costs incurred by Agent or the Lenders in connection with enforcement of the Lenders’ rights in a bankruptcy or insolvency proceeding filed by or against Borrower or its Property; provided that the Borrower shall only pay for the reasonable fees and expenses of one legal counsel (for clarity, other than with respect to in-house counsel for any Lender and the internal allocated costs of such in-house counsel to the extent applicable) for the Lenders in connection with any such amendment, modification, enforcement or defense of the Loan Documents.

“Lien” means any voluntary or involuntary security interest, pledge, bailment, lease, mortgage, hypothecation, conditional sales and title retention agreement, encumbrance or other lien with respect to any Property in favor of any Person.

“Loan” means the advance of credit by the Lenders pursuant to Advances under this Agreement, and “Loans” means collectively all such Advances.

“Loan Documents” means, collectively, this Agreement, each Note, each Warrant, any Landlord Agreement, any Account Control Agreement and all other documents, instruments and agreements entered into in connection with this Agreement, all as amended or extended from time to time.

“Loan Rate” means the fixed per annum rate of interest (based on a 360-day year of twelve 30-day months) equal to 9.00%.

“Major Lender” means any Lender which holds more than \$1,000,000 of the Indebtedness outstanding under this Agreement at any time or any Lender which funded not less than \$1,000,000 of the aggregate Initial Advance under this Agreement.

“Maturity Date” means (A) the earlier of (i) thirty-six (36) months after the Effective Date, (ii) the consummation of a Change in Control, or (iii) the consummation of an IPO, or (B) if earlier, the date of acceleration of Advances following an Event of Default or the date of prepayment, whichever is applicable.

“[***] Account” has the meaning given such term in Section 7.13 of this Agreement.

“Note” means each promissory note executed in connection with the Loans in substantially the form of Exhibit C attached hereto, and collectively, “Notes” means all such promissory notes.

[***] = CERTAIN INFORMATION ON THIS PAGE HAS BEEN OMITTED AND FILED SEPARATELY WITH THE COMMISSION. CONFIDENTIAL TREATMENT HAS BEEN REQUESTED WITH RESPECT TO THE OMITTED PORTIONS.

“**Obligations**” means all debt, principal, interest, fees, charges, expenses and attorneys’ fees and costs and other amounts, obligations, covenants, and duties owing by Borrower to Agent or any Lender of any kind and description pursuant to or evidenced by the Loan Documents (other than any Warrant(s) in favor of any Lender), whether direct or indirect, absolute or contingent, due or to become due, now existing or hereafter arising, including all Lenders’ Expenses.

“**Officer’s Certificate**” means a certificate executed by a Responsible Officer substantially in the form of Exhibit E or such other form as Lender may agree to accept.

“**Payment Date**” has the meaning given such term in Section 2.2(a) of this Agreement.

“**Permitted Indebtedness**” means and includes:

- (a) Indebtedness of Borrower to the Lenders;
- (b) Indebtedness arising from the endorsement of instruments in the ordinary course of business;
- (c) Indebtedness existing on the date hereof and set forth on the Disclosure Schedule;

(d) Indebtedness (i) in an aggregate principal amount not exceeding Twenty Five Million Dollars (\$25,000,000) in favor of Bridge, Comerica and the other lenders pursuant to the Senior Secured Loan and Security Agreement (under which the aggregate amount of loans, as of the Effective Date, are limited to not more than Eighty Percent (80%) of Borrower’s outstanding accounts receivable and Fifty Percent (50%) of Borrower’s eligible inventory) and (ii) in an aggregate principal amount not exceeding Twelve Million Dollars (\$12,000,000) in favor of Horizon and any other lenders pursuant to the Senior Subordinated Secured Loan and Security Agreement;

(e) Indebtedness secured by a lien described in clause (g) of the defined term “Permitted Liens,” provided (i) such Indebtedness does not exceed the lesser of the cost or fair market value of the equipment financed with such Indebtedness (in each case measured at the time of incurrence of such Indebtedness) and (ii) such Indebtedness does not exceed Five Million Dollars (\$5,000,000) in the aggregate at any given time; and

(f) Indebtedness to Oracle America, Inc. or one of its affiliates, including Oracle Credit Corporation in an aggregate amount not to exceed \$500,000;

- (g) Inter-company Indebtedness incurred in the ordinary course of business;
- (h) Other Indebtedness in an aggregate amount not exceeding Seven Hundred Fifty Thousand Dollars (\$750,000) at any time;
- (i) Subordinated Debt; and

(j) extensions, refinancings, modifications, amendments and restatements of any items of Permitted Indebtedness (a) through (i) above, provided that the principal amount thereof is not increased or the terms thereof are not modified to impose more burdensome terms upon Borrower or its Subsidiary, as the case may be.

“Permitted Investments” means and includes any of the following Investments as to which Lender has a perfected security interest:

(a) Deposits and deposit accounts with commercial banks organized under the laws of the United States or a state thereof to the extent: (i) the deposit accounts of each such institution are insured by the Federal Deposit Insurance Corporation up to the legal limit; and (ii) each such institution has an aggregate capital and surplus of not less than One Hundred Million Dollars (\$100,000,000);

(b) Investments made in accordance with Borrower’s board approved short term investment policy;

(c) Investments in marketable obligations issued or fully guaranteed by the United States and maturing not more than one (1) year from the date of issuance;

(d) Investments in open market commercial paper rated at least “A1” or “P1” or higher by a national credit rating agency and maturing not more than one (1) year from the creation thereof;

(e) Investments pursuant to or arising under currency agreements or interest rate agreements entered into in the ordinary course of business;

(f) Investments consisting of (i) travel advances and employee relocation loans and other employee loans and advances in the ordinary course of business, and (ii) loans to employees, officers or directors relating to the purchase of equity securities of Borrower or its Subsidiaries pursuant to employee stock purchase plans or agreements approved by Borrower’s Board of Directors; not to exceed Two Hundred Fifty Thousand Dollars (\$250,000) in the aggregate in any fiscal year;

(g) Investments (including debt obligations) received in connection with the bankruptcy or reorganization of customers or suppliers and in settlement of delinquent obligations of, and other disputes with, customers or suppliers arising in the ordinary course of business;

(h) Investments consisting of notes receivable of, or prepaid royalties and other credit extensions, to customers and suppliers who are not Affiliates, in the ordinary course of business; provided that this paragraph (g) shall not apply to Investments of Borrower in any Subsidiary;

(i) Investments in Subsidiaries made in the ordinary course of business, not to exceed Four Million Five Hundred Thousand and 00/100 Dollars (\$4,500,000) in the aggregate in any fiscal year;

(j) (x) joint ventures or strategic alliances in the ordinary course of Borrower’s business consisting of the nonexclusive licensing of technology, the development of technology or the providing of technical support, provided that any cash investments by Borrower do not exceed Five Hundred Thousand Dollars (\$500,000) in the aggregate in any fiscal year; and (y) strategic alliances with particular customers in which such customers will share in the research and development expense of Borrower associated with the incorporation by such customers of microconverters purchased from Borrower into solar panels produced by such customers; and

(k) Other Investments in an amount not in excess of an aggregate amount equal to Two Hundred Fifty Thousand Dollars (\$250,000) at any time.

“Permitted Liens” means and includes:

(a) the Lien created by this Agreement;

(b) Liens for fees, taxes, levies, imposts, duties or other governmental charges of any kind which are not yet delinquent or which are being contested in good faith by appropriate proceedings which suspend the collection thereof (provided that such appropriate proceedings do not involve any substantial danger of the sale, forfeiture or loss of any material item of Collateral which in the aggregate is material to Borrower and that Borrower has adequately bonded such Lien or reserves sufficient to discharge such Lien have been provided on the books of Borrower);

(c) Liens identified on the Disclosure Schedule;

(d) carriers’, warehousemen’s, mechanics’, materialmen’s, repairmen’s or other similar Liens arising in the ordinary course of business and which are not delinquent or remain payable without penalty or which are being contested in good faith and by appropriate proceedings (provided that such appropriate proceedings do not involve any substantial danger of the sale, forfeiture or loss of any material item of Collateral or Collateral which in the aggregate is material to Borrower and that Borrower has adequately bonded such Lien or reserves sufficient to discharge such Lien have been provided on the books of Borrower);

(e) Liens granted in connection with Indebtedness permitted under subsection (d) of the definition of Permitted Indebtedness; provided that such liens shall be subject to the Subordination Agreement;

(f) non-exclusive licenses of Intellectual Property entered into in the ordinary course of business, and licenses of Intellectual Property that could not result in a legal transfer of title of the licensed property that may be exclusive in respects other than territory and that may be exclusive as to territory only as to discreet geographical areas outside of the United States.

(g) Liens (i) upon or in any equipment which was not financed by Lender acquired or held by Borrower or any of its Subsidiaries to secure the purchase price of such equipment or indebtedness incurred solely for the purpose of financing the acquisition of such equipment, or (ii) existing on such equipment at the time of its acquisition, provided that the Lien is confined solely to the property so acquired and improvements thereon, and the proceeds of such equipment;

(h) Liens to secure payment of workers’ compensation, employment insurance, old-age pensions, social security and other like obligations incurred in the ordinary course of business (other than Liens imposed by ERISA);

(i) Liens arising from attachments or judgments, orders, or decrees in circumstances not constituting an Event of Default under Sections 8.5 and 8.8;

(j) Liens in favor of customs and revenue authorities incurred in the ordinary course of business to secure payment of custom duties in connection with the importation of goods;

(k) leases or subleases of real property granted in the ordinary course of Borrower’s business (or, if referring to another Person, in the ordinary course of such Person’s business), and leases, subleases, non-exclusive licenses or sublicenses of personal property (other than Intellectual Property) granted in the ordinary course of Borrower’s business (or, if referring to another Person, in the

ordinary course of such Person's business), if the leases, subleases, licenses and sublicenses do not prohibit granting a security interest therein; and

(l) Liens incurred in connection with the extension, renewal or refinancing of the indebtedness secured by Liens of the type described in clauses (a) through (k) above, provided that any extension, renewal or replacement Lien shall be limited to the property encumbered by the existing Lien and the principal amount of the indebtedness being extended, renewed or refinanced does not increase;

"Person" means and includes any individual, any partnership, any corporation, any business trust, any joint stock company, any limited liability company, any unincorporated association or any other entity and any domestic or foreign national, state or local government, any political subdivision thereof, and any department, agency, authority or bureau of any of the foregoing.

"PIK Interest" has the meaning given such term in Section 2.2.

"Property" means any interest in any kind of property or asset, whether real, personal or mixed, whether tangible or intangible.

"Pro Rata Share" has the meaning given such term in Section 2.1(a) of this Agreement.

"Required Lenders" means those Lenders holding more than 60% of the Indebtedness outstanding under this Agreement.

"Responsible Officer" has the meaning given such term in Section 6.3 of this Agreement.

"Rights to Payment" has the meaning given such term in Section 4.1(g) of this Agreement.

"Securities Act" means the Securities Act of 1933, as amended, and the rules and regulations promulgated thereunder.

"Senior Secured Loan and Security Agreement" means that certain Amended and Restated Loan and Security Agreement dated as of March 24, 2011 by and among Borrower, as the "Borrower" thereunder, Bridge Bank, National Association ("Bridge"), as a "Lender" and the "Collateral Agent" thereunder, and Comerica Bank ("Comerica"), as a "Lender" thereunder, as modified, amended and/or restated from time to time.

"Senior Subordinated Secured Loan and Security Agreement" means that certain Amended and Restated Venture Loan and Security Agreement dated as of March 25, 2011 by and among Borrower, as the "Borrower" thereunder, and each of Horizon Technology Finance Corporation, a Delaware corporation ("Horizon Technology") and Horizon Credit LLC, a Delaware limited liability company ("Horizon Credit," and together with Horizon Technology, referred to herein as "Horizon") as "Lenders" and/or "Holders" thereunder, as modified, amended and/or restated from time to time.

"Solvent" has the meaning given such term in Section 5.11 of this Agreement.

"Subordinated Debt" means any debt incurred by Borrower that is subordinated to the debt owing by Borrower to Lender hereunder or under any of the Loan Documents on terms acceptable to the Lenders (and identified as being such by Borrower and Lenders).

“Subordination Agreement” means one (1) or more subordination agreements and/or intercreditor agreement (as modified, amended and/or restated from time to time) among each of Bridge, Comerica, and the Agent on behalf of the Lenders hereunder, and between Horizon and Agent on behalf of the Lenders hereunder, in respect of the subordination of the Encumbrances and Indebtedness evidenced by this Agreement and all Advances made hereunder in relation to the Indebtedness evidenced by the Senior Secured Loan and Security Agreement and the Senior Subordinated Secured Loan and Security Agreement, in form and substance satisfactory to the Agent.

“Subsequent Advance” has the meaning given such term in Section 2.1(a) of this Agreement.

“Subsequent Equity Financing” means the next round or rounds of equity financing, subsequent to the Effective Date, in which Borrower issues and sells shares of its capital stock (other than shares of capital stock sold in a transaction that would be exempt from the anti-dilution rights of the holders of Borrower’s preferred stock pursuant to clauses (i) through (viii) of Article V, Section 5.8 of Borrower’s certificate of incorporation, as currently in effect) for aggregate cash proceeds in excess of \$10,000,000.

“Subsidiary” means any corporation or other entity of which a majority of the outstanding Equity Securities entitled to vote for the election of directors or other governing body (otherwise than as the result of a default) is owned by Borrower directly or indirectly through Subsidiaries, including without limitation Enphase Energy SAS, Enphase Energy SRL and Enphase Energy New Zealand Limited.

“Third Party Equipment” has the meaning given such term in Section 4.8 of this Agreement.

“Transfer” has the meaning given such term in Section 7.4 of this Agreement.

“Warrants” has the meaning given such term in the recitals hereto.

“Warranty Claim Rate” means, with respect to a given period of time, the ratio of (i) the number of microinverters shipped by or on behalf of Borrower during such period of time (x) that have been subject to a return merchandise authorization (“RMA”) or warranty claim or (y) for which Borrower has received written notice of a RMA, warranty claim or for which Borrower has knowledge of an event or circumstance that is likely to give rise to a RMA or warranty claim, over (ii) the total number of microinverters shipped by or on behalf of Borrower during such period of time. For purposes of this definition, Borrower will be deemed to have knowledge of such event or circumstance if (A) such event or circumstance is reflected in one or more documents (whether written or electronic, including electronic emails sent to or by an executive officer or director of Borrower or a Subsidiary or (B) if such knowledge could be obtained from reasonable inquiry of persons employed or engaged by Borrower or such Subsidiary charged with principal administrative or operational responsibility for such matter for such entity (if an executive officer of Borrower or such Subsidiary does not already have such principal administrative or operational responsibility).

1.2 Construction. References in this Agreement to “Articles,” “Sections,” “Exhibits,” “Schedules” and “Annexes” are to recitals, articles, sections, exhibits, schedules and annexes herein and hereto unless otherwise indicated. References in this Agreement and each of the other Loan Documents to any document, instrument or agreement shall include (a) all exhibits, schedules, annexes and other attachments thereto, (b) all documents, instruments or agreements issued or executed in replacement thereof, and (c) such document, instrument or agreement, or replacement or predecessor thereto, as amended, modified and supplemented from time to time and in effect at any given time. The words “hereof,” “herein” and “hereunder” and words of similar import when used in this Agreement or any other Loan Document shall refer to this Agreement or such other Loan Document, as the case may be, as a whole and not to any particular provision of this Agreement or such other Loan Document, as the case

may be. The words “include” and “including” and words of similar import when used in this Agreement or any other Loan Document shall not be construed to be limiting or exclusive. Unless otherwise indicated in this Agreement or any other Loan Document, all accounting terms used in this Agreement or any other Loan Document shall be construed, and all accounting and financial computations hereunder or thereunder shall be computed, in accordance with GAAP, and all terms describing Collateral shall be construed in accordance with the Code. The terms and information set forth on the cover page of this Agreement are incorporated into this Agreement.

2. Loans; Repayment.

2.1 Commitment; Purchase of Warrants or Common Stock.

(a) The Commitment Amount. Subject to the terms and conditions of this Agreement and relying upon the representations and warranties of Borrower set forth herein, the Lenders agree, severally and not jointly, in accordance with each Lender’s pro rata share of the aggregate Commitment Amount (“Pro Rata Share”) as set forth on Schedule I, to make (i) an initial Advance on the Effective Date in an aggregate amount of \$12,500,000 (the “Initial Advance”) in the amounts for each Lender set forth on Schedule I hereto, and (ii) one or more subsequent Advances, in a minimum aggregate amount of \$500,000 for any such subsequent Advance (each, a “Subsequent Advance”), in accordance with each Lender’s Pro Rata Share of such Advance, up to an aggregate maximum amount of Subsequent Advances of \$37,500,000. Notwithstanding the foregoing, to the extent that as of any Funding Request Notice Date (as defined in Section 2.5 below) the Company has filed (and not withdrawn) a registration statement on Form S-1 (or any successor or similar form) with the Securities and Exchange Commission for a public offering of securities, the Company may at its discretion limit participation in the Subsequent Advances to the Lenders set forth on Schedule I-A. In such event, the non-participating Lenders shall be deemed to have waived any right to participate in such Subsequent Advance. In the event that participation in the Subsequent Advance is limited to the Lenders on Schedule I-A, such Lenders may in their sole discretion fund, in addition to their Pro Rata Share of the Advance, an amount equal to Pro Rata Share of the Advances of the Lenders not listed on Schedule I-A based on the Pro Rata Share of the Advance for each such Lender relative to the Pro Rata Share of the Advance for all the Lenders listed on Schedule I-A.

(b) Failures to Fund Commitment Amount. If Borrower has requested an Advance pursuant to Section 2.5(a) of this Agreement and all of the conditions to the Lender’s obligation to make such Advance as set forth in Section 3 have been satisfied or waived, then (A) if a Lender has nonetheless failed to advance his, her or its Pro Rata Share of an Advance (hereinafter, with respect to any applicable Lender, referred to as the “Unfunded Capital Commitment Amount”) and such failure is not remedied within five Business Days after written notice thereof is provided by Borrower to such Lender (the date of such notice, a “Default Notice Date”), in addition to any other remedies Borrower may have for breach of this Agreement, such Lender shall be assessed and shall immediately pay to Borrower a fee in an amount equal to 5% multiplied by the amount of such Lender’s Unfunded Capital Commitment Amount (such Lender hereinafter referred to as a “Defaulting Lender”), and (B) if such Defaulting Lender fails to fund such Unfunded Capital Commitment Amount within ten Business Days after the proposed Default Notice Date, in addition to any other remedies Borrower may have for breach of this Agreement, such Defaulting Lender shall be assessed and shall immediately pay to Borrower an additional fee in an amount equal to 5% multiplied by the amount of such Defaulting Lender’s Unfunded Capital Commitment Amount, such Defaulting Lender shall forfeit the right to participate in any future requests for Advances made by Borrower, and the other non-Defaulting Lenders who participated in such Advance may fund their respective pro rata shares of the Unfunded Capital Commitment Amount of the Defaulting Lender based on the Pro Rata Share of the Advance for such non-Defaulting Lenders relative to the Pro Rata Share of the Advance for all the non-Defaulting Lenders. To the extent that any Defaulting Lender

does not pay the fee, the amount of the outstanding Obligations for such Defaulting Lender shall be reduced by the amount of such fee. In no event shall a Lender be deemed a Defaulting Lender if the Lender is unable to make a Subsequent Advance because the Company limits participation in the Subsequent Advances to the Lenders on Schedule I-A pursuant to Section 2.1(a) above.

(c) Loans Evidenced by Notes. The obligation of Borrower to repay the unpaid principal amount of and all PIK Interest on the Loans shall be evidenced by one or more Notes, or in the case of Subsequent Advances addendums to the applicable original Notes issued to the Lenders in connection with the first Subsequent Advance.

(d) Issuance of Warrants or Common Stock. On the Funding Date for the Initial Advance, (i) for each Lender specified on Schedule I hereto as purchasing shares of Common Stock, Borrower shall issue and sell to such Lender, and such Lender shall purchase from Borrower, the number of shares of Common Stock set forth opposite such Lender's name on Schedule I hereto, at a purchase price of \$0.58 per share, and in connection with such purchase the Lender hereby makes to Borrower the representations and warranties set forth in Section 5 of Schedule II, and (ii) for each other Lender, the Company shall issue such Lender a Warrant covering the number of shares of Common Stock set forth opposite such Lender's name in Schedule I hereto.

(e) Use of Proceeds. The proceeds of the Loans shall be used solely for working capital and other general corporate purposes of Borrower.

(f) Termination of Commitment to Lend. Notwithstanding anything in the Loan Documents, the Lenders obligation to lend the undisbursed portion of the Commitment Amount to Borrower hereunder shall terminate on the earlier of (i) at the Required Lenders' sole election, the occurrence of any Default or Event of Default hereunder, and (ii) the applicable Commitment Termination Date.

2.2 Conversion; Payments.

(a) Lender's Option to Convert. The outstanding balances of the Loans made hereunder shall be convertible into capital stock of Borrower on the terms and conditions set forth in Schedule II to this Agreement.

(b) Repayment of Initial Advance and Subsequent Advances. Subject to the terms and conditions of the Subordination Agreement, all Loans made under this Agreement (including all unpaid principal, accrued interest and PIK Interest thereon) shall be due and payable in full on the Maturity Date, except to the extent a Loan has been prepaid pursuant to Section 2.3 or converted into capital stock of Borrower pursuant to Schedule II.

(c) Interest on Loans. Subject to Sections 2.2(a) and (b), the Loans shall bear interest (in addition to any "original issue discount" as defined in the IRC) at the Loan Rate from the date of the applicable Advance, compounding monthly on each Interest Payment Date; provided, however, Borrower shall not pay such interest in cash but instead all such accrued and unpaid interest shall be paid in kind as described in the immediately following sentence, on each Interest Payment Date (any such interest paid in kind, the "PIK Interest"). All interest due and payable hereunder by Borrower shall be capitalized, added to the then-outstanding principal amount of the Loans as additional principal obligations hereunder on and as of such Interest Payment Date and shall automatically constitute a part of the outstanding principal amount of the Loans for all purposes hereof (including the accrual of interest thereon at the rates applicable to the Loans generally). Any determination of the principal amount outstanding under the Loans after giving effect to any PIK Interest hereunder or otherwise that is

reasonably made by the Agent or the Lenders in good faith shall be prima facie evidence of the correctness of such determination in the absence of manifest error. All computations of interest (including interest at the Default Rate, if applicable) shall be based on a year of twelve 30-day months. Notwithstanding any other provision hereof, the amount of interest payable hereunder shall not in any event exceed the maximum amount permitted by the law applicable to interest charged on commercial loans.

(d) Application of Payments. All payments due to the Lenders hereunder prior to an Event of Default shall be applied as follows: (1) first, to Lenders' Expenses then due and owing, if applicable, and (2) second, pro rata to the outstanding Loans under Advances made by the Lenders. After an Event of Default, all payments and application of proceeds shall be made as set forth in Section 9.7.

(e) Default Rate. Borrower shall pay interest at a per annum rate equal to the Default Rate on any amounts required to be paid by Borrower under this Agreement or the other Loan Documents, payable with respect to each Loan, accrued and unpaid interest, and any fees or other amounts which remain unpaid after such amounts are due. If an Event of Default has occurred and the Obligations have been accelerated (whether automatically or by Lender's election), Borrower shall pay interest on the aggregate, outstanding accelerated balance hereunder from the date of the Event of Default until all Events of Default are cured, at a per annum rate equal to the Default Rate.

2.3 Prepayments.

(a) Mandatory Prepayment Upon an Acceleration. If a Loan is accelerated following the occurrence of an Event of Default pursuant to Section 9.1(a) hereof, then Borrower, in addition to any other amounts which may be due and owing hereunder, shall immediately pay to Lender the amount set forth in Section 2.3(b) below, as if Borrower had opted to prepay on the date of such acceleration.

(b) Subject to the terms of Section 2.3(a), no prepayments shall be permitted with respect to the Convertible Portion of the Loans (as defined in Schedule II to this Agreement) Upon ten (10) Business Days' prior written notice to each Lender, Borrower may, at its option, at any time, prepay all or any portion of the Loans comprising only the Non-Convertible Portion of the Loans by paying to such Lender an amount equal to (i) any accrued and unpaid interest and PIK Interest on the outstanding principal balance of such Loan(s); (ii) the outstanding principal balance of such Loan(s) and (iii) all other sums, if any, that shall have become due and payable hereunder.

2.4 Other Payment Terms.

(a) Place and Manner. Borrower shall make all payments due to the Lenders in lawful money of the United States. All payments of principal, PIK Interest, fees and other amounts payable by Borrower hereunder shall be made, in immediately available funds, not later than 10:00 a.m. Pacific time, on the date on which such payment is due. Borrower shall make such payments to each Lender via wire transfer in immediately available funds or ACH or by certified check at the address set forth for such Lender in Schedule I, as indicated by such Lender in Schedule I (or in a writing delivered by such Lender to Borrower from and after the Effective Date).

(b) Date. Whenever any payment is due hereunder on a day other than a Business Day, such payment shall be made on the next succeeding Business Day, and such extension of time shall be included in the computation of interest or fees, as the case may be.

2.5 Procedure for Making the Loans.

(a) Notice. Borrower shall notify each Lender in writing (which may be via electronic mail) of the Funding Date and deliver a completed Funding Certificate by 5:00 p.m. Eastern on a date (the "Funding Request Notice Date") at least five (5) Business Days in advance of the desired Funding Date (it being understood that the Lenders shall have five (5) Business Days from the delivery of such written notice and completed Funding Certificate to review and verify the information set forth in the applicable Funding Certificate and the satisfaction of the conditions precedent for the requested Advance and to confirm the satisfaction of the conditions precedent for such Advance by and through the Agent acting on the Lenders' behalf with respect to such confirmation to Borrower, including by means of requests for the production of additional information by the Agent to Borrower), unless the Lenders elect at the Lenders' sole discretion to allow the Funding Date to be within five (5) Business Days of Borrower's notice and delivery of a Funding Certificate the notice of which election would be made by the Agent at the direction of such Lenders to Borrower. Any such written notice and Funding Certificate delivered to the Lenders after 5:00 p.m. Eastern on the Funding Request Notice Date shall be deemed received the following Business Day by the Lenders. Borrower's execution and delivery to each of the Lenders of a Note (or in the case of Subsequent Advances an addendum to the original Note issued to the applicable Lender) shall be Borrower's agreement to the terms and calculations thereunder and hereunder with respect to the Advance made by such Lender. Each Lender's several and not joint obligation to make any Advance shall be expressly subject to the satisfaction of the conditions set forth in Section 3.

(b) Disbursement. Each Lender shall, in accordance with such Lender's Pro Rata Share of such Advance, disburse the proceeds of each Loan by wire transfer to Borrower at the account specified in the Funding Certificate for such Loan. Disbursements shall be made net of any Lenders' Expenses owing at the time of such disbursement.

3. Conditions of Loans and Acquisition of Warrants or Common Stock.

3.1 Conditions Precedent to Closing. At the time of the execution and delivery of this Agreement, the Agent shall have received, in form and substance satisfactory to the Agent, all of the following (unless the Required Lenders have agreed to waive such condition or document, in which case such condition or document shall be a condition precedent to the making of the applicable Advance by the Lenders and shall be deemed added to Section 3.2):

(a) Loan Agreement. This Agreement duly executed by Borrower, the Agent and the Lenders.

(b) Secretary's Certificate. A certificate of the secretary or assistant secretary of Borrower with copies of the following documents attached:

(i) the certificate of incorporation and bylaws of Borrower certified by Borrower as being complete and in full force and effect on the date thereof, (ii) incumbency and representative signatures, and (iii) resolutions authorizing the execution and delivery of this Agreement and each of the other Loan Documents.

(c) Good Standing Certificates. A good standing certificate from Borrower's state of incorporation and the state in which Borrower's principal place of business is located, each dated as of a recent date.

(d) Certificate of Insurance. Evidence of the insurance coverage required by Section 6.8 of this Agreement.

(e) Consents. All necessary consents of shareholders and other third parties with respect to the execution, delivery and performance of this Agreement, the Warrants and the other Loan Documents.

(f) Legal Opinion. A legal opinion of Borrower's counsel in form satisfactory to Agent, in substantially the form attached as Exhibit D hereto.

(g) Account Control Agreements. Account Control Agreements for all of Borrower's deposit accounts and accounts holding securities, except for the Italian Account, the French Account, the [***] Account and the [***] Account, duly executed by all of the parties thereto, in the forms provided by or reasonably acceptable to Agent.

(h) Other Documents. Such other documents and completion of such other matters, as Agent may reasonably deem necessary or appropriate.

3.2 Conditions Precedent to Making the Initial Advance and Acquisition of Warrant or Common Stock. Each Lender's several and not joint obligation to make the Initial Advance and either acquire Warrants or purchase Common Stock, as further described in Sections 2.1(a)(i) and/or 2.1(d), as applicable, is further subject to the following conditions precedent:

(a) No Default. No Default or Event of Default shall have occurred and be continuing.

(b) Representations and Warranties. The representations and warranties of Borrower in this Agreement and the other Loan Documents shall be true, accurate, and complete in all material respects on the proposed funding date of the Initial Advance.

(c) Landlord Agreements. Borrower shall have provided the Agent with a Landlord Agreement in form and substance reasonably satisfactory to the Agent or each location where Borrower's books and records and the Collateral are located (unless Borrower is the fee owner thereof).

(d) Note. Borrower shall have duly executed and delivered to each of the Lenders a Note in the amount of such Lender's Pro Rata Share of the Initial Advance.

(e) UCC Financing Statements. The Agent shall have received such documents, instruments and agreements, including UCC financing statements or amendments to UCC financing statements, as the Agent shall reasonably request to evidence the perfection and priority of the security interests granted to the Agent on behalf of the Lenders pursuant to Section 4. Borrower authorizes the Agent to file any UCC financing statements, continuations of or amendments to UCC financing statements it deems necessary to perfect its security interest in the Collateral.

(f) Funding Certificate. Borrower shall have duly executed and delivered to each Lender a Funding Certificate for the Initial Advance.

(g) Intercreditor Agreement. An intercreditor and/or subordination agreement with respect to the Indebtedness constituting Permitted Indebtedness under subsections (c), (d) and (e) of the definition of Permitted Indebtedness, executed by the banks, financial institutions and other lenders or authorized agents thereof, providing such Indebtedness.

[***] = CERTAIN INFORMATION ON THIS PAGE HAS BEEN OMITTED AND FILED SEPARATELY WITH THE COMMISSION. CONFIDENTIAL TREATMENT HAS BEEN REQUESTED WITH RESPECT TO THE OMITTED PORTIONS.

(h) Warrant. Borrower shall have executed and delivered to each Lender electing to receive a Warrant an original Warrant, covering that number of shares of Common Stock set forth in Schedule I to this Agreement for such Lender.

(i) Common Stock. Borrower shall have executed and delivered to each Lender electing to purchase Common Stock an original stock certificate evidencing that number of shares of Common Stock set forth in Schedule I to this Agreement for such Lender.

(j) Lenders' Expenses. Borrower shall have paid (or provided for the payment of) all Lenders' Expenses owing as of the Funding Date for the Initial Advance.

(k) Other Documents. Such other documents and completion of such other matters, as Agent may reasonably deem necessary or appropriate.

3.3 Condition to the Subsequent Advances. For each Subsequent Advance requested by Borrower, each Lender's several and not joint obligation to make such Subsequent Advance shall be subject to the following conditions precedent:

(a) Initial Advance. The conditions set forth in Sections 3.1 and 3.2 shall have been satisfied, and the Lenders shall have made the Initial Advance.

(b) Funding Certificate. Borrower shall have duly executed and delivered to each Lender a Funding Certificate for such Subsequent Advance.

(c) No Default. No Default or Event of Default shall have occurred and be continuing.

(d) Representations and Warranties. The representations and warranties of Borrower in this Agreement and the other Loan Documents shall be true, accurate, and complete in all material respects on the proposed funding date of the Subsequent Advance.

(e) Addendum to Note. Borrower shall have duly executed and delivered to each of the Lenders an addendum setting forth the amount of such Lender's Pro Rata Share of such Subsequent Advance and the date of funding for such Subsequent Advance, in the form set forth in Exhibit C to this Agreement, which such Lender may attach to its original Note evidencing its portion of the Initial Advance.

(f) Gross Profit Condition. Borrower shall have had, as of the end of the most recently ended fiscal quarter, minimum Gross Profit for the period of two consecutive quarters then most recently ended of not less than the following:

Sum of Two Consecutive Fiscal Quarter Period	Gross Profit
For fiscal quarter ending March 31, 2011 and fiscal quarter ending June 30, 2011	\$ [***]
For fiscal quarter ending June 30, 2011 and fiscal quarter ending September 30, 2011	\$ [***]

[***] = CERTAIN INFORMATION ON THIS PAGE HAS BEEN OMITTED AND FILED SEPARATELY WITH THE COMMISSION. CONFIDENTIAL TREATMENT HAS BEEN REQUESTED WITH RESPECT TO THE OMITTED PORTIONS.

For fiscal quarter ending September 30, 2011 and fiscal quarter ending December 31, 2011	\$[***]
For fiscal quarter ending December 31, 2011 and fiscal quarter ending March 31, 2012	\$[***]
For fiscal quarter ending March 31, 2012 and fiscal quarter ending June 30, 2012	\$[***]
For fiscal quarter ending June 30, 2012 and fiscal quarter ending September 30, 2012	\$[***]
For fiscal quarter ending September 30, 2012 and fiscal quarter ending December 31, 2012	\$[***]

(g) Inverter Warranty Claims. The Warranty Claim Rate for microinverters shipped by or on behalf of Borrower during both (i) the three (3) month and (ii) the six (6) month period preceding the date of Borrower's Funding Certificate for such Subsequent Advance shall be no more than [***] ([***]).

(h) Limitation on Number of Advances Per Quarter. During the calendar quarter in which such Subsequent Advance is requested, Borrower shall have requested no more than one (1) other Subsequent Advance.

(i) Lenders' Expenses. Borrower shall have paid (or provided for the payment of) all Lenders' Expenses owing as of the Funding Date for such Subsequent Advance.

(j) Other Documents. Borrower shall have executed and delivered to the Agent such other documents, and completed such other matters, as the Agent may reasonably deem necessary or appropriate.

3.4 Covenant to Deliver. Borrower agrees (not as a condition but as a covenant) to deliver to Agent and/or each Lender, as the case may be, each item required to be delivered to Agent and/or such Lender as a condition to each Advance, if such Advance is advanced. Borrower expressly agrees that the extension of such Advance prior to the receipt by Agent and/or such Lender of any such item shall not constitute a waiver by Agent and/or such Lender of Borrower's obligation to deliver such item, and any such extension in the absence of a required item shall be in Agent's sole discretion (with respect to any matters set forth in Sections 3.1, 3.2 or 3.3 expressly subject to Agent's sole discretion) and/or such Lender's discretion (with respect to any matters set forth in Sections 3.1, 3.2 or 3.3 expressly subject to a Lender's sole discretion).

3.5 Lender Representations and Covenants. In connection with the issuance of the Notes and Warrants, each Lender makes the representations and warranties and covenants set forth in Section 5 of Schedule II.

4. Creation of Security Interest.

4.1 Grant of Security Interest. Borrower grants to Agent, for the ratable benefit of each Lender, a valid and continuing security interest in all presently existing and hereafter acquired or arising Collateral in order to secure prompt, full and complete payment of any and all Obligations (other than

[***] = CERTAIN INFORMATION ON THIS PAGE HAS BEEN OMITTED AND FILED SEPARATELY WITH THE COMMISSION. CONFIDENTIAL TREATMENT HAS BEEN REQUESTED WITH RESPECT TO THE OMITTED PORTIONS.

the Warrants and inchoate indemnity obligations) and in order to secure prompt, full and complete performance by Borrower of each of its covenants and duties under each of the Loan Documents (other than the Warrant). The “Collateral” shall mean and include all right, title, interest, claims and demands of Borrower in and to all personal property of Borrower, including, without limitation, all of the following:

(a) All goods (and embedded computer programs and supporting information included within the definition of “goods” under the Code) and equipment now owned or hereafter acquired, including, without limitation, all laboratory equipment, computer equipment, office equipment, machinery, fixtures, vehicles (including motor vehicles and trailers), and any interest in any of the foregoing, and all attachments, accessories, accessions, replacements, substitutions, additions, and improvements to any of the foregoing, wherever located;

(b) All inventory now owned or hereafter acquired, including, without limitation, all merchandise, raw materials, parts, supplies, packing and shipping materials, work in process and finished products including such inventory as is temporarily out of Borrower’s custody or possession or in transit and including any returns upon any accounts or other proceeds, including insurance proceeds, resulting from the sale or disposition of any of the foregoing and any documents of title representing any of the above, and Borrower’s books relating to any of the foregoing;

(c) All contract rights and general intangibles (except to the extent included within the definition of Intellectual Property), now owned or hereafter acquired, including, without limitation, goodwill, license agreements, franchise agreements, blueprints, drawings, purchase orders, customer lists, route lists, infringements, claims, software, computer programs, computer disks, computer tapes, literature, reports, catalogs, design rights, income tax refunds, payment intangibles, commercial tort claims, payments of insurance and rights to payment of any kind;

(d) All now existing and hereafter arising accounts, contract rights, royalties, license rights, license fees and all other forms of obligations owing to Borrower arising out of the sale or lease of goods, the licensing of technology or the rendering of services by Borrower (subject, in each case, to the contractual rights of third parties to require funds received by Borrower to be expended in a particular manner), whether or not earned by performance, and any and all credit insurance, guaranties, and other security therefor, as well as all merchandise returned to or reclaimed by Borrower and Borrower’s books relating to any of the foregoing;

(e) All documents, cash, deposit accounts, letters of credit (whether or not the letter of credit is evidenced by a writing), certificates of deposit, instruments, promissory notes, chattel paper (whether tangible or electronic) and investment property, including, without limitation, all securities, whether certificated or uncertificated, security entitlements, securities accounts, commodity contracts and commodity accounts, and all financial assets held in any securities account or otherwise, wherever located, now owned or hereafter acquired and Borrower’s books relating to the foregoing;

(f) Any and all claims, rights and interests in any of the above and all substitutions for, additions and accessions to and proceeds thereof, including, without limitation, insurance, condemnation, requisition or similar payments and proceeds of the sale or licensing of Intellectual Property to the extent such proceeds no longer constitute Intellectual Property; and

(g) Notwithstanding the foregoing, the Collateral shall not include any Intellectual Property; provided, however, that the Collateral shall include all accounts receivables, accounts, and general intangibles that consist of rights to payment and proceeds from the sale, licensing or disposition of all or any part, or rights in, the foregoing (the “Rights to Payment”). Notwithstanding the

foregoing, if a judicial authority (including a U.S. Bankruptcy Court) holds that a security interest in the underlying Intellectual Property is necessary to have a security interest in the Rights to Payment, then the Collateral shall automatically, and effective as of the date hereof, include the Intellectual Property to the extent necessary to permit perfection of Lender's security interest in the Rights to Payment.

Notwithstanding the foregoing, the term "Collateral" shall not include (A) equipment identified on Annex I to the Disclosure Schedule, or (B) or rights of Borrower as a licensee; in each case of (A) and (B) to the extent the granting of a security interest therein (i) would be contrary to applicable law or (ii) is prohibited by or would constitute a default under any agreement or document governing such property (but only to the extent such prohibition is enforceable under applicable law); provided that upon the termination or lapsing of any such prohibition, such property shall automatically be part of the Collateral; and provided further that the provisions of this paragraph shall in no case exclude from the definition of "Collateral" any Accounts, proceeds of the disposition of any property, or general intangibles consisting of rights to payment, all of which shall at all times constitute "Collateral"; and provided further that any Equipment financed by Agent or the Lenders, if any, will at all times constitute "Collateral".

4.2 After-Acquired Property. If Borrower shall at any time acquire a commercial tort claim, as defined in the Code, Borrower shall immediately notify Agent in writing signed by Borrower of the brief details thereof and grant to Lender in such writing a security interest therein and in the proceeds thereof, all upon the terms of this Agreement, with such writing to be in form and substance satisfactory to Lender.

4.3 Duration of Security Interest. Agent's security interest in the Collateral shall continue until the payment in full and the satisfaction of all Obligations (other than inchoate indemnity obligations) and termination of Agent and each of the other Lender's commitment to fund the Loans, whereupon such security interest shall terminate. Agent shall, at Borrower's sole cost and expense, execute such further documents and take such further actions as may be reasonably necessary to make effective the release contemplated by this Section 4.3, including duly authorizing and delivering termination statements for filing in all relevant jurisdictions under the Code.

4.4 Location and Possession of Collateral. Other than for Borrower's personal property located at Flextronics and for Transfers permitted under Section 7.4, the Collateral is and shall remain in the possession of Borrower at its location listed on the cover page hereof or as set forth in the Disclosure Schedule. Borrower shall remain in full possession, enjoyment and control of the Collateral (except only as may be otherwise required by Agent for perfection of its security interest therein) and so long as no Event of Default has occurred, shall be entitled to manage, operate and use the same and each part thereof with the rights and franchises appertaining thereto; provided that the possession, enjoyment, control and use of the Collateral shall at all time be subject to the observance and performance of the terms of this Agreement.

4.5 Delivery of Additional Documentation Required. Borrower shall from time to time execute and deliver to Agent, at the request of Lender, all financing statements and other documents Agent may reasonably request, in form satisfactory to Agent, to perfect and continue Agent's perfected security interests in the Collateral and in order to consummate fully all of the transactions contemplated under the Loan Documents.

4.6 Right to Inspect. Agent (through any of its officers, directors, employees, or agents) shall have the right, upon reasonable prior notice, from time to time during Borrower's usual business hours, to inspect Borrower's books and records and to make copies thereof and to inspect, test, and appraise the Collateral in order to verify Borrower's financial condition or the amount, condition of, or any other matter relating to, the Collateral.

4.7 Protection of Intellectual Property. Borrower shall (i) protect, defend and maintain the validity and enforceability of its Intellectual Property to the extent Borrower deems it appropriate to do so in its reasonable business judgment and promptly advises Lender in writing of material infringements, and (ii) not allow any Intellectual Property material to Borrower's business to be abandoned, forfeited or dedicated to the public without Agent's written consent.

4.8 Lien Subordination. Agent agrees that the Liens granted to it hereunder on behalf of and for the ratable benefit of the Lenders under this Agreement shall be subordinate in payment and to the Liens to secure the Indebtedness permitted under clauses (c), (d) and (e) of the definition of Permitted Indebtedness subject to and in accordance with the terms and provisions of the Subordination Agreement. So long as no Event of Default has occurred, Agent agrees to execute and deliver such agreements and documents as may be reasonably requested by Borrower from time to time which set forth the payment and lien subordination described in this Section 4.8 and the Subordination Agreement and are reasonably acceptable to Agent.

5. Representations and Warranties. Except as set forth in the Disclosure Schedule, Borrower represents and warrants as follows:

5.1 Organization and Qualification. Borrower is a corporation duly organized and validly existing under the laws of its state of incorporation and qualified and licensed to do business in, and is in good standing in, any state in which the conduct of its business or its ownership of Property requires that it be so qualified or in which the Collateral is located, except for such states as to which any failure to so qualify would not have a material adverse effect on Borrower.

5.2 Authority; Valid Issuance of Common Stock. Borrower has all necessary power and authority to execute, deliver, and perform in accordance with the terms thereof, the Loan Documents to which it is a party. Borrower has all requisite power and authority to own and operate its Property and to carry on its businesses as now conducted. Borrower has obtained all licenses, permits, approvals and other authorizations necessary for the operation of its business. All shares of Common Stock to be purchased by Lenders hereunder are duly authorized, validly issued, fully paid and non-assessable, and free of any Liens except for restrictions on transfer provided for herein or under applicable federal and state securities laws.

5.3 Conflict with Other Instruments, etc. Neither the execution and delivery of any Loan Document to which Borrower is a party nor the consummation of the transactions therein contemplated nor compliance with the terms, conditions and provisions thereof will conflict with or result in a breach of any of the terms, conditions or provisions of the certificate of incorporation, the by-laws, or any other organizational documents of Borrower or any law or any regulation, order, writ, injunction or decree of any court or governmental instrumentality or any material agreement or instrument to which Borrower is a party or by which it or any of its Property is bound or to which it or any of its Property is subject, or constitute a default thereunder or result in the creation or imposition of any Lien, other than Permitted Liens.

5.4 Authorization; Enforceability. The execution and delivery of this Agreement, the granting of the security interest in the Collateral, the incurring of the Loans, the execution and delivery of the other Loan Documents to which Borrower is a party and the consummation of the transactions herein and therein contemplated have each been duly authorized by all necessary action on the part of Borrower. No authorization, consent, approval, license or exemption of, and no registration, qualification, designation, declaration or filing with, or notice to, any Person is, was or will be necessary to (i) the valid execution and delivery of any Loan Document to which Borrower is a party, (ii) the performance of Borrower's obligations under any Loan Document, or (iii) the granting of the security

interest in the Collateral, except for filings in connection with the perfection of the security interest in any of the Collateral or the issuance of the Warrants. The Loan Documents have been duly executed and delivered and constitute legal, valid and binding obligations of Borrower, enforceable in accordance with their respective terms, except as the enforceability thereof may be limited by bankruptcy, insolvency or other similar laws of general application relating to or affecting the enforcement of creditors' rights or by general principles of equity.

5.5 No Prior Encumbrances. Borrower has good and marketable title to the Collateral, free and clear of Liens except for Permitted Liens. Borrower has good title and ownership of, or is licensed under, all of Borrower's current Intellectual Property. Borrower has not received any communications alleging that Borrower has violated, or by conducting its business as proposed, would violate any proprietary rights of any other Person. Borrower has no knowledge of any infringement or violation by it of the intellectual property rights of any third party and has no knowledge of any violation or infringement by a third party of any of its Intellectual Property. The Collateral and the Intellectual Property constitute substantially all of the assets and property of Borrower.

5.6 Name; Location of Chief Executive Office, Principal Place of Business and Collateral. Except as set forth on the Disclosure Schedule, Borrower has not done business under any name other than that specified on the signature page hereof. Borrower's jurisdiction of incorporation, chief executive office, principal place of business, and the place where Borrower maintains its records concerning the Collateral are presently located in the state and at the address set forth on the cover page of this Agreement. The Collateral is presently located at the address set forth on the cover page hereof or as set forth in the Disclosure Schedule.

5.7 Litigation. There are no actions or proceedings pending by or against Borrower before any court or administrative agency in which an adverse decision could have a material adverse effect on Borrower or the aggregate value of the Collateral. Borrower does not have knowledge of any such pending or threatened actions or proceedings.

5.8 Financial Statements. All financial statements relating to Borrower or any Affiliate that have been or may hereafter be delivered by Borrower to Agent present fairly in all material respects Borrower's financial condition as of the date thereof and Borrower's results of operations for the period then ended.

5.9 No Material Adverse Effect. No event has occurred and no condition exists which could reasonably be expected to have a material adverse effect on the financial condition, business or operations of Borrower since December 31, 2010; provided that any adverse effect that results from general economic or industry conditions, which do not affect Borrower in a disproportionate manner relative to other participants in the economy or such industry, as applicable, shall be disregarded in determining whether there has been or would be a material adverse effect on Borrower.

5.10 Full Disclosure. No representation, warranty or other statement made by Borrower in any Loan Document (including the Disclosure Schedule), certificate or written statement furnished to Lender contains any untrue statement of a material fact or omits to state a material fact necessary in order to make the statements contained in such certificates or statements not misleading. There is no fact known to Borrower which materially adversely affects, or which could in the future be reasonably expected to materially adversely affect, its ability to perform its obligations under this Agreement.

5.11 Solvency, Etc. Borrower is Solvent (as defined below) and, after the execution and delivery of the Loan Documents and the consummation of the transactions contemplated thereby,

Borrower will be Solvent. "Solvent" means, with respect to any Person on any date, that on such date such Person is able to pay its debts (including trade debts) as they mature.

5.12 Subsidiaries. Borrower has no Subsidiaries as of the date hereof other than Enphase Energy SAS, Enphase Energy SRL and Enphase Energy New Zealand Limited.

5.13 Catastrophic Events; Labor Disputes. Neither Borrower nor its properties is or has been affected by any fire, explosion, accident, strike, lockout or other labor dispute, drought, storm, hail, earthquake, embargo, act of God or other casualty that could reasonably be expected to have a material adverse effect on the financial condition, business or operations of Borrower. There are no disputes presently subject to grievance procedure, arbitration or litigation under any of the collective bargaining agreements, employment contracts or employee welfare or incentive plans to which Borrower is a party, and there are no strikes, lockouts, work stoppages or slowdowns, or, to the knowledge of Borrower, jurisdictional disputes or organizing activity occurring or threatened which could reasonably be expected to have a material adverse effect on the financial condition, business or operations of Borrower.

5.14 Certain Agreements of Officers, Employees and Consultants. To the knowledge of Borrower, no officer, employee or consultant of Borrower is, or is now expected to be, in violation of any term of any employment contract, proprietary information agreement, nondisclosure agreement, noncompetition agreement or any other material contract or agreement or any restrictive covenant relating to the right of any such officer, employee or consultant to be employed by Borrower because of the nature of the business conducted or to be conducted by Borrower or relating to the use of trade secrets or proprietary information of others, and to Borrower's knowledge, the continued employment of Borrower's officers, employees and consultants does not subject Borrower to any material liability for any claim or claims arising out of or in connection with any such contract, agreement, or covenant.

5.15 No Present Intention to Terminate. To the knowledge of Borrower, no officer of Borrower, and no employee or consultant of Borrower whose termination, either individually or in the aggregate, could reasonably be expected to have a material adverse effect on the financial condition, business or operations of Borrower, has any present intention of terminating his or her employment or consulting relationship with Borrower.

6. Affirmative Covenants. Borrower, until the full and complete payment of the Obligations (other than inchoate indemnity obligations), covenants and agrees that:

6.1 Good Standing. Borrower shall maintain its corporate existence and its good standing in its jurisdiction of incorporation and maintain qualification in each jurisdiction in which the failure to so qualify could reasonably be expected to have a material adverse effect on the financial condition, operations or business of Borrower. Borrower shall maintain in force all licenses, approvals and agreements, the loss of which could reasonably be expected to have a material adverse effect on its financial condition, operations or business.

6.2 Government Compliance. Borrower shall comply with all statutes, laws, ordinances and government rules and regulations to which it is subject, noncompliance with which could reasonably be expected to materially adversely affect the financial condition, operations or business of Borrower.

6.3 Financial Statements, Reports, Certificates. Until such time as Borrower shall have become a publicly reporting company under the Exchange Act, Borrower shall deliver to Agent and each of the Major Lenders (and any other Lender upon such Lender's written request to Borrower): (a) as soon as available, but in any event within thirty (30) days after the end of each month, a company

prepared balance sheet, income statement and cash flow statement covering Borrower's operations during such period, certified by Borrower's president, controller or chief financial officer (each, a "Responsible Officer"); (b) as soon as available, but in any event within one hundred eighty (180) days after the end of Borrower's fiscal year commencing with Borrowers' fiscal year 2010, audited financial statements of Borrower prepared in accordance with GAAP, together with an unqualified opinion (other than a qualification for a going concern) on such financial statements of a nationally recognized or other independent public accounting firm reasonably acceptable to Agent; (c) as soon as available, but in any event within ninety (90) days after the end of Borrower's fiscal year or the date of Borrower's board of directors' adoption, Borrower's operating budget and plan for the next fiscal year and (d) such other financial information as the Lenders may reasonably request from time to time. In addition, Borrower shall deliver to Agent and each of the Major Lenders (and any other Lender upon such Lender's written request to Borrower): (i) promptly upon becoming available, copies of all statements, reports and notices sent or made available generally by Borrower to its security holders; and (ii) immediately upon receipt of notice thereof, a report of any material legal actions pending or threatened against Borrower or the commencement of any action, proceeding or governmental investigation involving Borrower is commenced that is reasonably expected to result in damages or costs to Borrower of Two Hundred Fifty Thousand Dollars (\$250,000).

6.4 Certificates of Compliance. Until such time as Borrower shall have become a publicly reporting company under the Exchange Act, each time financial statements are furnished pursuant to Section 6.3 above, Borrower shall deliver to Agent an Officer's Certificate signed by a Responsible Officer in the form of, and certifying to the matters set forth in Exhibit E hereto.

6.5 Notice of Defaults. As soon as possible, and in any event within five (5) days after the discovery of an Event of Default, Borrower shall provide the Agent with an Officer's Certificate setting forth the facts relating to or giving rise to such Event of Default and the action which Borrower proposes to take with respect thereto.

6.6 Taxes. Borrower shall make due and timely payment or deposit of all federal, state, and local taxes, assessments, or contributions required of it by law or imposed upon any Property belonging to it, and will execute and deliver to the Agent, on demand, appropriate certificates attesting to the payment or deposit thereof; and Borrower will make timely payment or deposit of all tax payments and withholding taxes required of it by applicable laws, including those laws concerning F.I.C.A., F.U.T.A., state disability, and local, state, and federal income taxes, and will, upon request, furnish Lender with proof satisfactory to Agent indicating that Borrower has made such payments or deposits; provided that Borrower need not make any payment if the amount or validity of such payment is contested in good faith by appropriate proceedings which suspend the collection thereof (provided that such proceedings do not involve any substantial danger of the sale, forfeiture or loss of any material item of Collateral or Collateral which in the aggregate is material to Borrower and that Borrower has adequately bonded such amounts or reserves sufficient to discharge such amounts have been provided on the books of Borrower).

6.7 Use; Maintenance. Borrower shall keep and maintain all items of equipment and other similar types of personal property that form any significant portion or portions of the Collateral in good operating condition and repair and shall make all necessary replacements thereof and renewals thereto so that the value and operating efficiency thereof shall at all times be maintained and preserved. Borrower shall not permit any such material item of Collateral to become a fixture to real estate or an accession to other personal property, without the prior written consent of Lender. Borrower shall not permit any such material item of Collateral to be operated or maintained in violation of any applicable law, statute, rule or regulation. With respect to items of leased equipment (to the extent Agent has any security interest in any residual Borrower's interest in such equipment under the lease), Borrower shall

keep, maintain, repair, replace and operate such leased equipment in accordance with the terms of the applicable lease.

6.8 Insurance. Borrower shall keep its business and the Collateral insured for risks and in amounts, as the Agent may reasonably request. Insurance policies shall be in a form, with companies, and in amounts that are satisfactory to Agent. All property policies shall have a lender's loss payable endorsement showing Agent on behalf of and for the ratable benefit of the Lenders as an additional loss payee and all liability policies shall show Agent as an additional insured. Borrower shall provide Agent at least twenty (20) days notice before cancellation of its insurance policies. At Agent's request, Borrower shall deliver certified copies of policies and evidence of all premium payments. Proceeds payable under any property policy shall, at Agent's option, be payable to Agent on behalf of and for the ratable benefit of the Lenders on account of the Obligations. Notwithstanding the foregoing, so long as no Event of Default has occurred and is continuing, Borrower shall have the option of applying the proceeds of any property policy, toward the replacement or repair of destroyed or damaged property; provided that (i) any such replaced or repaired property (a) shall be of equal or like value as the replaced or repaired Collateral and (b) shall be deemed Collateral in which Lender has been granted a first priority security interest and (ii) after the occurrence and during the continuation of an Event of Default all proceeds payable under such property policy shall, at the option of Lender, be payable to Lender, on account of the Obligations. If Borrower fails to obtain insurance as required under Section 6.8 or to pay any amount or furnish any required proof of payment to third persons and Lender, Lender may make all or part of such payment or obtain such insurance policies required in Section 6.8, and take any action under the policies Lender deems prudent. On or prior to the first Funding Date and prior to each policy renewal, Borrower shall furnish to Lender certificates of insurance or other evidence satisfactory to Lender that insurance complying with all of the above requirements is in effect.

6.9 Security Interest. Assuming the proper filing of one or more financing statement(s) identifying the Collateral with the proper state and/or local authorities, the security interests in the Collateral granted to Lender pursuant to this Agreement (i) constitute and will continue to constitute first priority security interests (except to the extent any Permitted Liens may have a superior priority to Agent's Lien under this Agreement) and (ii) are and will continue to be superior and prior to the rights of all other creditors of Borrower (except to the extent of such Permitted Liens).

6.10 Further Assurances. At any time and from time to time Borrower shall execute and deliver such further instruments and take such further action as may reasonably be requested by Agent to make effective the purposes of this Agreement, including without limitation, the continued perfection and priority of Agent's security interest in the Collateral.

6.11 Subsidiaries. Borrower, upon Agent's reasonable request, shall cause any Subsidiary of Borrower to provide Lender with a guaranty of the Obligations and a security interest in such Subsidiary's assets to secure such guaranty. Borrower shall not create or otherwise have any Subsidiaries after the date hereof, except for Subsidiaries for which Borrower obtained Agent's prior written consent (which consent shall not be unreasonably withheld, conditioned or delayed) and otherwise subject to the first sentence of this Section 6.11.

6.12 Notices Regarding Warranty Claim Rate. If as of the first day of any calendar month prior to the Commitment Termination Date, the Warranty Claim Rate for microinverters shipped by or on behalf of Borrower during either the (i) the preceding three (3) month period or (ii) the preceding six (6) month period is greater than one percent (1%), then Borrower shall notify the Agent in writing (within 7 days after the beginning of such calendar month) and shall provide such information relating to related warranty claims as Agent (on behalf of the Lenders) may reasonably request.

7. Negative Covenants. Borrower, until the full and complete payment of the Obligations (other than inchoate indemnity obligations), covenants and agrees that Borrower shall not without Agent's prior written consent, which shall not be unreasonably withheld:

7.1 Chief Executive Office. Change its name, jurisdiction of incorporation, chief executive office, principal place of business or any of the items set forth in Section 1 of the Disclosure Schedule without thirty (30) days prior written notice to Agent.

7.2 Collateral Control. Subject to its rights under Section 4.4 and other than for Transfers permitted under Section 7.4, remove any items of Collateral from Borrower's facility located at the address set forth on the cover page hereof or as set forth on the Disclosure Schedule.

7.3 Liens. Create, incur, assume or suffer to exist any Lien of any kind upon any of Borrower's Property, whether now owned or hereafter acquired, except Permitted Liens.

7.4 Other Dispositions of Collateral. Convey, sell, lease or otherwise dispose of all or any part of the Collateral to any Person (collectively, a "Transfer"), except for: (i) Transfers of inventory in the ordinary course of business; (ii) Transfers of worn-out or obsolete equipment; (iii) Transfers permitted under subclause (f) of the definition of Permitted Liens with respect to Collateral, (iv) Transfers in connection with Permitted Liens and Permitted Investments; or (v) Transfers that are not otherwise permitted under this Section 7.4 in an amount not to exceed Two Hundred Fifty Thousand Dollars (\$100,000) in the aggregate in any fiscal year.

7.5 Distributions. (i) Pay any dividends or make any distributions on its Equity Securities; (ii) purchase, redeem, retire, defease or otherwise acquire for value any of its Equity Securities (other than repurchases pursuant to the terms of employee stock purchase plans, employee restricted stock agreements or similar arrangements in an aggregate amount not to exceed Two Hundred Fifty Thousand Dollars (\$250,000)); (iii) return any capital to any holder of its Equity Securities as such; (iv) make any distribution of assets, Equity Securities, obligations or securities to any holder of its Equity Securities as such; or (v) set apart any sum for any such purpose; provided, however, Borrower may pay dividends payable solely in Borrower's common stock.

7.6 Mergers or Acquisitions. Merge or consolidate with or into any other Person (other than mergers or consolidations of a Subsidiary into another Subsidiary or into Borrower) or acquire all or substantially all of the capital stock or assets of another.

7.7 Change in Ownership. (A) Engage in or permit any of its Subsidiaries to engage in any business other than the businesses currently engaged in by Borrower or reasonably related thereto or (B) have a material change in its ownership of greater than forty nine percent (49%) (other than by the sale by Borrower of Borrower's Equity Securities in a public offering or to venture capital investors so long as Borrower identifies to the Agent the venture capital investors prior to the closing of the investment) (clause (B) of this Section 7.7 referred to in this Agreement sometimes as a "Change in Control").

7.8 Transactions With Affiliates/Subsidiaries. (a) Enter into any contractual obligation with any Affiliate or engage in any other transaction with any Affiliate except (i) upon terms at least as favorable to Borrower as an arms-length transaction with Persons who are not Affiliates of Borrower or are otherwise approved by the disinterested members of Borrower's board of directors, and (ii) Borrower's sale of equity and debt securities (provided that such debt securities are Subordinated Debt) to venture capital or other strategic investors or (b) create a Subsidiary, unless, at Agent's election, such Subsidiary guarantees the Obligations and grants a security interest in its assets to secure such guaranty,

provided that Lender further agrees not to unreasonably withhold, condition or delay its consent to the creation of a Subsidiary.

7.9 Indebtedness Payments. (i) Prepay, redeem, purchase, defease or otherwise satisfy in any manner prior to the scheduled repayment thereof any Indebtedness for borrowed money or lease obligations (other than (i) Indebtedness or lease obligations in an aggregate amount not to exceed \$250,000 per fiscal year, (ii) amounts due or permitted to be prepaid under this Agreement, or (iii) Permitted Indebtedness including without limitation under any revolving credit agreement constituting Permitted Indebtedness under clause (d) of the definition of Permitted Indebtedness and Indebtedness owing to Atel Ventures, Inc. (collectively, the “Excluded Indebtedness”), (ii) amend, modify or otherwise change the terms of any Indebtedness for borrowed money or lease obligations (other than Excluded Indebtedness) so as to accelerate the scheduled repayment thereof or (iii) repay any notes to officers, directors or shareholders other than converting any such notes into equity securities of the company.

7.10 Indebtedness. Create, incur, assume or permit to exist any Indebtedness except Permitted Indebtedness.

7.11 Investments. Make any Investment except for Permitted Investments.

7.12 Compliance. Become an “investment company” or a company controlled by an “investment company” under the Investment Company Act of 1940 or undertake as one of its important activities extending credit to purchase or carry margin stock, or use the proceeds of any Loan for that purpose; fail to meet the minimum funding requirements of the Employment Retirement Income Security Act of 1974, and its regulations, as amended from time to time (“ERISA”), permit a Reportable Event or Prohibited Transaction, as defined in ERISA, to occur; fail to comply with the Federal Fair Labor Standards Act or violate any other law or regulation, if the violation could reasonably be expected to have a material adverse effect on Borrower’s business or operations or could reasonably be expected to cause a material adverse change, or permit any of its Subsidiaries to do so.

7.13 Maintenance of Accounts. (i) Maintain any deposit account or account holding securities owned by Borrower except (a) accounts with the lender providing Borrower with Indebtedness permitted under subsection (d) of the definition of Permitted Indebtedness or (b) accounts with respect to which Lender is able to take such actions as it deems necessary to obtain a perfected security interest in such accounts through one or more Account Control Agreements; or (ii) grant or allow any other Person (other than Lender) to perfect a security interest in, or enter into any agreements with any Persons (other than Lender) accomplishing perfection via control as to any of its deposit accounts or accounts holding securities other than in favor of the lender providing Borrower with Indebtedness permitted under subsection (d) of the definition of Permitted Indebtedness. Notwithstanding the foregoing, Borrower may maintain: (1) a deposit account at [***], having account number [***] (the “Italian Account”), (2) a deposit account with [***] having account number [***] (the “French Account”) and collectively with the Italian Account, the “Foreign Accounts”), (3) a deposit account with [***], having an account number of [***] (the “[***]”) and (4) a deposit account to be established with [***] (the “[***] Account”), provided that (x) less than One Million Euros (€ 1,000,000) in the aggregate is maintained by Borrower in the Foreign Accounts and (y) less than Five Thousand Dollars (\$5,000) is maintained by Borrower in the [***] Account.

7.14 Negative Pledge Regarding Intellectual Property. Create, incur, assume or suffer to exist any Lien of any kind upon any Intellectual Property or Transfer any Intellectual Property (other

[***] = CERTAIN INFORMATION ON THIS PAGE HAS BEEN OMITTED AND FILED SEPARATELY WITH THE COMMISSION. CONFIDENTIAL TREATMENT HAS BEEN REQUESTED WITH RESPECT TO THE OMITTED PORTIONS.

than for Transfers permitted under subclause (f) of the definition of Permitted Liens), whether now owned or hereafter acquired.

7.15 Inventory and Equipment. Store Inventory or Equipment with an aggregate value in excess of Fifty Thousand Dollars (\$50,000) with a bailee, warehouseman, or other third party other than Flextronics (international or domestic locations) unless the third party has been notified of Lender's security interest and Lender (a) has received an acknowledgment from the third party that it is holding or will hold the Inventory or Equipment for Lender's benefit or (b) is in pledge possession of the warehouse receipt, where negotiable, covering such Inventory or Equipment. Store or maintain any Equipment or Inventory with an aggregate value in excess of Fifty Thousand Dollars (\$50,000) at a location other than at Flextronics (international or domestic locations) or the location set forth in Section 10 of this Agreement. Notwithstanding the foregoing, Borrower may maintain up to One Million Dollars (\$1,000,000) in raw materials in transit (from Borrower's supplier(s) to Flextronics' manufacturing facility in China), without complying with (a) or (b), above.

8. Events of Default. Any one or more of the following events shall constitute an "Event of Default" by Borrower under this Agreement:

8.1 Failure to Pay. If Borrower fails to (i) make any payment of principal or interest under a Loan when due and payable or when declared due and payable in accordance with the Loan Documents or (ii) pay any other portion of the Obligations within five (5) days after receipt of written notice from Lender that such payment is due.

8.2 Certain Covenant Defaults. If Borrower fails to perform any obligation under violates any of the covenants contained in Section 7 of this Agreement.

8.3 Other Covenant Defaults. If Borrower fails or neglects to perform, keep, or observe any other material term, provision, condition, covenant, or agreement contained in this Agreement (other than as set forth in Sections 8.1, 8.2 or 8.4 through 8.11), in any of the other Loan Documents and Borrower has failed to cure such default within fifteen (15) days of the occurrence of such default. During this fifteen (15) day period, the failure to cure the default is not an Event of Default (but no Loan will be made during the cure period).

8.4 Seizure of Assets, Etc. If any material portion of Borrower's assets is attached, seized, subjected to a writ or distress warrant, or is levied upon, or comes into the possession of any trustee, receiver or Person acting in a similar capacity and such attachment, seizure, writ or distress warrant or levy has not been removed, discharged or rescinded within ten (10) days, or if Borrower is enjoined, restrained, or in any way prevented by court order from continuing to conduct all or any material part of its business affairs, or if a judgment or other claim becomes a lien or encumbrance upon any material portion of Borrower's assets, or if a notice of lien, levy, or assessment is filed of record with respect to any of Borrower's assets by the United States Government, or any department, agency, or instrumentality thereof, or by any state, county, municipal, or governmental agency, and the same is not paid within ten (10) days after Borrower receives notice thereof; provided that none of the foregoing shall constitute an Event of Default where such action or event is stayed or an adequate bond has been posted pending a good faith contest by Borrower.

8.5 Service of Process. The service of process upon Agent or any Lender seeking to attach by a trustee or other process any funds of Borrower on deposit or otherwise held by Agent or such Lender, or the delivery upon Agent or any Lender of a notice of foreclosure by any Person seeking to attach or foreclose on any funds of Borrower on deposit or otherwise held by Agent or any Lender, or the delivery of a notice of foreclosure or exclusive control to any entity holding or maintaining

Borrower's deposit accounts or accounts holding securities by any Person (other than any of the Lenders) seeking to foreclose or attach any such accounts or securities.

8.6 Default on Indebtedness. One or more defaults or events of default shall exist under any agreement with any third party or parties which consists of the failure to pay any Indebtedness at maturity or which results in a right by such third party or parties, whether or not exercised, to accelerate the maturity of Indebtedness in an aggregate amount in excess of Two Hundred Fifty Thousand Dollars (\$250,000) provided, however, that the Event of Default under this Section 8.6 caused by a default or event of default under such other agreement shall be cured or waived for purposes of this Agreement upon Agent receiving written notice from the party asserting such default of such cure or waiver of the default under such other agreement, if at the time of such cure or waiver under such other agreement (x) the Lenders have not declared an Event of Default under this Agreement and/or exercised any rights with respect thereto; (y) any such cure or waiver does not result in an Event of Default under any other provision of this Agreement or any Loan Document; and (z) in connection with any such cure or waiver under such other agreement, the terms of any agreement with such third party are not modified or amended in any manner which could in the good faith judgment of Lender be materially less advantageous to Borrower or any Subsidiary.

8.7 Judgments. If a judgment or judgments for the payment of money in an amount, individually or in the aggregate, of at least Two Hundred Fifty Thousand Dollars (\$250,000) shall be rendered against Borrower and shall remain unsatisfied and unstayed for a period of ten (10) days or more.

8.8 Misrepresentations. If any material misrepresentation or material misstatement exists now or hereafter in any warranty, representation, statement, certification, or report made to Lender by Borrower or any officer, employee, agent, or director of Borrower.

8.9 Unenforceable Loan Document. If any Loan Document shall in any material respect cease to be, or Borrower shall assert that any Loan Document is not, a legal, valid and binding obligation of Borrower enforceable in accordance with its terms.

8.10 Involuntary Insolvency Proceeding. If a proceeding shall have been instituted in a court having jurisdiction in the premises seeking a decree or order for relief in respect of Borrower in an involuntary case under any applicable bankruptcy, insolvency or other similar law now or hereafter in effect, or for the appointment of a receiver, liquidator, assignee, custodian, trustee (or similar official) of Borrower or for any substantial part of its Property, or for the winding-up or liquidation of its affairs, and such proceeding shall remain undismissed or unstayed and in effect for a period of forty five (45) consecutive days or such court shall enter a decree or order granting the relief sought in such proceeding.

8.11 Voluntary Insolvency Proceeding. If Borrower shall commence a voluntary case under any applicable bankruptcy, insolvency or other similar law now or hereafter in effect, shall consent to the entry of an order for relief in an involuntary case under any such law, or shall consent to the appointment of or taking possession by a receiver, liquidator, assignee, trustee, custodian (or other similar official) of Borrower or for any substantial part of its Property, or shall make a general assignment for the benefit of creditors, or shall fail generally to pay its debts as they become due, or shall take any corporate action in furtherance of any of the foregoing.

9. Lenders' Rights and Remedies.

9.1 Rights and Remedies. Upon the occurrence of any Default or Event of Default, the Lenders shall not have any further obligation to advance money or extend credit to or for the benefit of

Borrower. In addition, upon the occurrence of an Event of Default, the Agent, on behalf of and for ratable the benefit of the Lenders, shall have the rights, options, duties and remedies of a secured party as permitted by law and, in addition to and without limitation of the foregoing, the Agent may, with the written consent or at the written direction of the Required Lenders, without notice of election and without demand, do any one or more of the following, all of which are authorized by Borrower:

(a) Acceleration of Obligations. Declare all Obligations, whether evidenced by this Agreement, by any of the other Loan Documents, or otherwise, including (i) any accrued and unpaid interest, (ii) the unpaid principal balance of the Loans and (iii) all other sums, if any, that shall have become due and payable hereunder, immediately due and payable (provided that upon the occurrence of an Event of Default described in Section 8.10 or 8.11 all Obligations shall become immediately due and payable without any action by Agent or any of the Lenders);

(b) Protection of Collateral. Make such payments and do such acts as Agent considers necessary or reasonable to protect Agent's security interest in the Collateral, on behalf of and for the ratable benefit of the Lenders. Borrower agrees to assemble the Collateral if Agent requires and to make the Collateral available to Agent as Agent may designate. Borrower authorizes Agent and its designees and agents to enter the premises where the Collateral is located, to take and maintain possession of the Collateral, or any part of it, and to pay, purchase, contest, or compromise any Lien which in Agent's determination appears or is claimed to be prior or superior to its security interest and to pay all expenses incurred in connection therewith. With respect to any of Borrower's owned premises, Borrower hereby grants Agent a license to enter into possession of such premises and to occupy the same, without charge, for up to one hundred twenty (120) days in order to exercise any of Agent's rights or remedies provided herein, at law, in equity, or otherwise;

(c) Preparation of Collateral for Sale. Ship, reclaim, recover, store, finish, maintain, repair, prepare for sale, advertise for sale, and sell (in the manner provided for herein) the Collateral. Agent and its agents and any purchasers at or after foreclosure are hereby granted a non-exclusive, irrevocable, perpetual, fully paid, royalty-free license or other right, solely pursuant to the provisions of this Section 9.1, to use, without charge, Borrower's Intellectual Property, including without limitation, labels, patents, copyrights, rights of use of any name, trade secrets, trade names, trademarks, service marks, and advertising matter, or any Property of a similar nature, now or at any time hereafter owned or acquired by Borrower or in which Borrower now or at any time hereafter has any rights; provided that such license shall only be exercisable in connection with the disposition of Collateral upon Agent's exercise of its remedies hereunder;

(d) Sale of Collateral. Sell the Collateral at either a public or private sale, or both, by way of one or more contracts or transactions, for cash or on terms, in such manner and at such places (including Borrower's premises) as Agent determines are commercially reasonable; and

(e) Purchase of Collateral. Credit bid and purchase all or any portion of the Collateral at any public sale.

Any deficiency that exists after disposition of the Collateral as provided above will be paid immediately by Borrower.

9.2 Set Off Right. Agent and the Lenders may set off and apply to the Obligations any and all indebtedness at any time owing to or for the credit or the account of Borrower or any other assets of Borrower in Agent's or any Lender's possession or control.

9.3 Effect of Sale. Upon the occurrence of an Event of Default, to the extent permitted by law, Borrower covenants that it will not at any time insist upon or plead, or in any manner whatsoever claim or take any benefit or advantage of, any stay or extension law now or at any time hereafter in force, nor claim, take nor insist upon any benefit or advantage of or from any law now or hereafter in force providing for the valuation or appraisal of the Collateral or any part thereof prior to any sale or sales thereof to be made pursuant to any provision herein contained, or to the decree, judgment or order of any court of competent jurisdiction; nor, after such sale or sales, claim or exercise any right under any statute now or hereafter made or enacted by any state or otherwise to redeem the property so sold or any part thereof, and, to the full extent legally permitted, except as to rights expressly provided herein, hereby expressly waives for itself and on behalf of each and every Person, except decree or judgment creditors of Borrower, acquiring any interest in or title to the Collateral or any part thereof subsequent to the date of this Agreement, all benefit and advantage of any such law or laws, and covenants that it will not invoke or utilize any such law or laws or otherwise hinder, delay or impede the execution of any power herein granted and delegated to Agent, but will suffer and permit the execution of every such power as though no such power, law or laws had been made or enacted. Any sale, whether under any power of sale hereby given or by virtue of judicial proceedings, shall operate to divest all right, title, interest, claim and demand whatsoever, either at law or in equity, of Borrower in and to the Property sold, and shall be a perpetual bar, both at law and in equity, against Borrower, its successors and assigns, and against any and all Persons claiming the Property sold or any part thereof under, by or through Borrower, its successors or assigns.

9.4 Power of Attorney in Respect of the Collateral. Borrower does hereby irrevocably appoint Agent (which appointment is coupled with an interest), the true and lawful attorney in fact of Borrower with full power of substitution, for it and in its name to file any notices of security interests, financing statements and continuations and amendments thereof pursuant to the Code or federal law, as may be necessary to perfect, or to continue the perfection of Agent's security interests in the Collateral. Borrower does hereby irrevocably appoint Agent (which appointment is coupled with an interest) on the occurrence of an Event of Default, the true and lawful attorney in fact of Borrower with full power of substitution, for it and in its name: (a) to ask, demand, collect, receive, receipt for, sue for, compound and give acquittance for any and all rents, issues, profits, avails, distributions, income, payment draws and other sums in which a security interest is granted under Section 4 with full power to settle, adjust or compromise any claim thereunder as fully as if Agent were Borrower itself; (b) to receive payment of and to endorse the name of Borrower to any items of Collateral (including checks, drafts and other orders for the payment of money) that come into Agent's possession or under Agent's control; (c) to make all demands, consents and waivers, or take any other action with respect to, the Collateral; (d) in Agent's discretion to file any claim or take any other action or proceedings, either in its own name or in the name of Borrower or otherwise, which Agent may reasonably deem necessary or appropriate to protect and preserve the right, title and interest of Agent in and to the Collateral; (e) endorse Borrower's name on any checks or other forms of payment or security; (f) sign Borrower's name on any invoice or bill of lading for any account or drafts against account debtors; (g) make, settle, and adjust all claims under Borrower's insurance policies; (h) settle and adjust disputes and claims about the accounts directly with account debtors, for amounts and on terms Agent determines reasonable; (i) transfer the Collateral into the name of Agent or a third party as the Code permits; and (j) to otherwise act with respect thereto as though Agent were the outright owner of the Collateral.

9.5 Lenders' Expenses. If Borrower fails to pay any amounts or furnish any required proof of payment due to third persons or entities, as required under the terms of this Agreement, then Agent, with the written consent or at the written direction of the Required Lenders, may do any or all of the following: (a) make payment of the same or any part thereof; or (b) obtain and maintain insurance policies of the type discussed in Section 6.8 of this Agreement, and take any action with respect to such policies as Agent deems prudent. Any amounts paid or deposited by Agent shall constitute Lenders'

Expenses (and payable and reimbursable to Agent), shall be immediately due and payable, shall bear interest at the Default Rate and shall be secured by the Collateral. Any payments made by Agent or any Lender shall not constitute an agreement by Agent or such Lender to make similar payments in the future or a waiver by Agent or such Lender of any Event of Default under this Agreement. Borrower shall pay all reasonable fees and expenses, including without limitation, Lenders' Expenses, incurred by Agent or any Lender in the enforcement or attempt to enforce any of the Obligations hereunder not performed when due.

9.6 Remedies Cumulative. Each of Agent's and each Lender's rights and remedies under this Agreement, the Loan Documents, and all other agreements shall be cumulative. Agent and each Lender shall have all other rights and remedies not inconsistent herewith as provided under the Code, by law, or in equity. No exercise by Agent or any Lender of one right or remedy shall be deemed an election, and no waiver by Agent or such Lender of any Event of Default on Borrower's part shall be deemed a continuing waiver. No delay by Agent or any Lender shall constitute a waiver, election, or acquiescence by it.

9.7 Application of Collateral Proceeds. The proceeds and/or avails of the Collateral, or any part thereof, and the proceeds and the avails of any remedy hereunder (as well as any other amounts of any kind held by Agent or any Lender, at the time of or received by Agent or any Lender after the occurrence of an Event of Default hereunder) shall be paid to and applied as follows:

(a) First, to the payment of out-of-pocket costs and expenses, including all amounts expended to preserve the value of the Collateral, of foreclosure or suit, if any, and of such sale and the exercise of any other rights or remedies, and of all proper fees, expenses, liability and advances, including reasonable legal expenses and attorneys' fees, incurred or made hereunder by Agent and the Lenders, including, without limitation, Lenders' Expenses;

(b) Second, to the payment to each Lender, on a ratable basis, of the amount then owing or unpaid on the Loans for any accrued and unpaid interest, the amounts which would have otherwise come due under Section 2.3(b)(ii), if the Loans had been voluntarily prepaid, the principal balance of the Loans, and all other Obligations with respect to the Loans held by such Lender (provided, however, if such proceeds shall be insufficient to pay in full the whole amount so due, owing or unpaid upon the Loans, then to the unpaid interest thereon, then to the amounts which would have otherwise come due under Section 2.3(b)(ii), if the Loans had been voluntarily prepaid, then to the principal balance of the Loans, and then to the payment of other amounts then payable to Lender under any of the Loan Documents); and

(c) Third, to the payment of the surplus, if any, to Borrower, its successors and assigns, or to the Person lawfully entitled to receive the same.

9.8 Reinstatement of Rights. If Agent and any Lender shall have proceeded to enforce any right under this Agreement or any other Loan Document by foreclosure, sale, entry or otherwise, and such proceedings shall have been discontinued or abandoned for any reason or shall have been determined adversely, then and in every such case (unless otherwise ordered by a court of competent jurisdiction), Agent and any such Lender shall be restored to its former position and rights hereunder with respect to the Property subject to the security interest created under this Agreement.

10. Waivers; Indemnification.

10.1 Demand; Protest. Borrower waives demand, protest, notice of protest, notice of default or dishonor, notice of payment and nonpayment, notice of any default, nonpayment at maturity,

release, compromise, settlement, extension, or renewal of accounts, documents, instruments, chattel paper, and guarantees at any time held by the Lenders on which Borrower may in any way be liable.

10.2 Lender's Liability for Collateral. So long as Agent or any Lender complies with its obligations, if any, under the Code, neither Agent nor any Lender shall in any way or manner be liable or responsible for: (a) the safekeeping of the Collateral; (b) any loss or damage thereto occurring or arising in any manner or fashion from any cause other than Lender's gross negligence or willful misconduct; (c) any diminution in the value thereof; or (d) any act or default of any carrier, warehouseman, bailee, forwarding agency, or other Person whomsoever. All risk of loss, damage or destruction of the Collateral shall be borne by Borrower.

10.3 Indemnification and Waiver. Whether or not the transactions contemplated hereby shall be consummated:

(a) General Indemnity. Borrower agrees upon demand to pay or reimburse each Lender for all liabilities, obligations and out-of-pocket expenses, including all Lenders' Expenses and reasonable fees and expenses of counsel for Lender from time to time arising in connection with the enforcement or collection of sums due under the Loan Documents, and in connection with any amendment or modification of the Loan Documents or any "work-out" in connection with the Loan Documents. Borrower shall indemnify, reimburse and hold each Lender, and each of its respective successors, assigns, agents, attorneys, officers, directors, equity holders, servants, agents and employees (each an "Indemnified Person") harmless from and against all liabilities, losses, damages, actions, suits, demands, claims of any kind and nature (including claims relating to environmental discharge, cleanup or compliance), all costs and expenses whatsoever to the extent they may be incurred or suffered by such Indemnified Person in connection therewith (including reasonable attorneys' fees and expenses), fines, penalties (and other charges of any applicable Governmental Authority), licensing fees relating to any item of Collateral, damage to or loss of use of property (including consequential or special damages to third parties or damages to Borrower's property), or bodily injury to or death of any person (including any agent or employee of Borrower) (each, a "Claim"), directly or indirectly relating to or arising out of the use of the proceeds of the Loans or otherwise, the falsity of any representation or warranty of Borrower or Borrower's failure to comply with the terms of this Agreement or any other Loan Document. The foregoing indemnity shall cover, without limitation, (i) any Claim in connection with a design or other defect (latent or patent) in any item of equipment or product included in the Collateral, (ii) any Claim for infringement of any patent, copyright, trademark or other intellectual property right, (iii) any Claim resulting from the presence on or under or the escape, seepage, leakage, spillage, discharge, emission or release of any Hazardous Materials on the premises owned, occupied or leased by Borrower, including any Claims asserted or arising under any Environmental Law, (iv) any Claim for negligence or strict or absolute liability in tort, or (v) any Claim asserted as to or arising under any Account Control Agreement or any Landlord Agreement; provided, however, Borrower shall not indemnify any Lender for any liability incurred by such Lender as a direct and sole result of such Lender's gross negligence or willful misconduct. Such indemnities shall continue in full force and effect, notwithstanding the expiration or termination of this Agreement. Upon any Lender's written demand, Borrower shall assume and diligently conduct, at its sole cost and expense, the entire defense of such Lender, each of its members, partners, and each of their respective, agents, employees, directors, officers, equity holders, successors and assigns against any indemnified Claim described in this Section 10.3(a). Borrower shall not settle or compromise any Claim against or involving any Lender without first obtaining such Lender's written consent thereto, which consent shall not be unreasonably withheld.

(b) Waiver. NOTWITHSTANDING ANYTHING TO THE CONTRARY CONTAINED IN THIS AGREEMENT OR ANYWHERE ELSE, BORROWER AGREES THAT IT

SHALL NOT SEEK FROM LENDER UNDER ANY THEORY OF LIABILITY (INCLUDING ANY THEORY IN TORTS), ANY SPECIAL, INDIRECT, CONSEQUENTIAL OR PUNITIVE DAMAGES.

(c) Survival; Defense. The obligations in this Section 10.3 shall survive payment of all other Obligations pursuant to Section 12.8. At the election of any Indemnified Person, Borrower shall defend such Indemnified Person using legal counsel satisfactory to such Indemnified Person in such Person's reasonable discretion, at the sole cost and expense of Borrower. All amounts owing under this Section 10.3 shall be paid within thirty (30) days after written demand.

11. Notices. Unless otherwise provided in this Agreement, all notices or demands by any party relating to this Agreement or any other agreement entered into in connection herewith shall be in writing and (except for financial statements and other informational documents which may be sent by first-class mail, postage prepaid or electronic mail) shall be personally delivered or sent by certified mail, postage prepaid, return receipt requested, by prepaid nationally recognized overnight courier, or by electronic mail or prepaid facsimile to Borrower or to Agent, as the case may be, at their respective addresses set forth below, and with respect to any other Lender, at their respective addresses set forth on Schedule I hereto:

If to Borrower:	Enphase Energy, Inc. 201 1 st Street, Suite 300 Petaluma, CA 94952 Attention: Chief Financial Officer, Sanjeev Kumar
If to Agent:	KPCB Holdings, Inc., as nominee 2750 Sand Hill Road Menlo Park, CA 94025 Attention: Ben Kortlang
With a copy to (which shall not constitute the giving of notice):	Fenwick & West LLP 801 California Street Mountain View, CA 94041 Attention: Sayre E. Stevick
If to any other Lender:	Per the address facsimile number and electronic mail address set forth in <u>Schedule I</u> to this Agreement.

The parties hereto may change the address at which they are to receive notices hereunder, by notice in writing in the foregoing manner given to the other. All such notices or demands shall be deemed to have been duly made or given: on the same day and at such time if personally delivered; three (3) Business Days after delivery by certified mail, postage prepaid, return receipt requested; one (1) Business Day after delivery by prepaid nationally recognized overnight courier; and on the same day and at such time if effected through electronic mail or prepaid facsimile (confirmed to have been received in the case of facsimile transmissions) on or prior to 5:00 p.m. Pacific or if thereafter the next Business Day.

12. Conversion; Agent and Agency; General Provisions.

12.1 Agent and Agency. Each of the Lenders hereunder acknowledges and agrees with and consents to the terms and provisions set forth in Schedule III to this Agreement with regard to KPCB's role as Agent under this Agreement.

12.2 Successors and Assigns. This Agreement and the Loan Documents shall bind and inure to the benefit of the respective successors and permitted assigns of each of the parties; provided, however, neither this Agreement nor any rights hereunder may be assigned by Borrower without the prior written consent of the Required Lenders, which consent may be granted or withheld in the sole discretion of the Required Lenders. Each Lender shall have the right without the consent of or notice to Borrower to sell, transfer, assign, negotiate, or grant participations (an "Assignment") in all or any part of, or any interest in such Lender's rights and benefits hereunder provided that such Lender shall cause to be executed and delivered by any such assignee an acknowledgement and consent that such assignee agrees to be bound by all the terms and provisions of this Agreement and the Loan Documents; provided further that, unless the prior written consent of Borrower shall have been obtained by such Lender, such Lender shall not sell, transfer, assign, negotiate or grant any participations in Advances held or in favor of such Lender to any competitor of Borrower set forth on Schedule 12.2 of the Disclosure Schedule and such Lender must sell, transfer and assign not less than the lesser of \$1,000,000 in Advances held by or in favor of such Lender or 100% of all Advances held by or in favor of such Lender. Each Lender may disclose the Loan Documents and any other financial or other information relating to Borrower or any Subsidiary to any potential participant or assignee of any of the Loans, provided that such participant or assignee agrees to protect the confidentiality of such documents and information using the same measures that it uses to protect its own confidential information.

12.3 Time of Essence. Time is of the essence for the performance of all obligations set forth in this Agreement.

12.4 Severability of Provisions. Each provision of this Agreement shall be severable from every other provision of this Agreement for the purpose of determining the legal enforceability of any specific provision.

12.5 Entire Agreement; Construction; Amendments and Waivers.

(a) Entire Agreement. This Agreement and each of the other Loan Documents dated as of the date hereof, taken together, constitute and contain the entire agreement among Borrower, Agent and the Lenders and supersede any and all prior agreements, negotiations, correspondence, understandings and communications between the parties, whether written or oral, respecting the subject matter hereof. Borrower acknowledges that it is not relying on any representation or agreement made by any Lender or any employee, attorney or agent thereof, other than the specific agreements set forth in this Agreement and the Loan Documents.

(b) Construction. This Agreement is the result of negotiations between and has been reviewed by each of Borrower, Agent and each Lender as of the date hereof and their respective counsel; accordingly, this Agreement shall be deemed to be the product of the parties hereto, and no ambiguity shall be construed in favor of or against Borrower, Agent or any Lender. Each of Borrower, Agent and each Lender agree that they intend the literal words of this Agreement and the other Loan Documents and that no parol evidence shall be necessary or appropriate to establish Borrower's, Agent's or such Lender's actual intentions.

(c) Amendments and Waivers. Any and all discharges or waivers of, or consents to any departures from any provision of this Agreement or of any of the other Loan Documents shall not be effective without the written consent of the Required Lenders. Any and all amendments and modifications of this Agreement or of any of the other Loan Documents shall not be effective without the written consent of Borrower and the Required Lenders. Any waiver or consent with respect to any provision of the Loan Documents shall be effective only in the specific instance and for the specific purpose for which it was given. No notice to or demand on Borrower in any case shall entitle Borrower

to any other or further notice or demand in similar or other circumstances. Any amendment, modification, waiver or consent affected in accordance with this Section 12.5(c) shall be binding upon the Lenders and on Borrower; provided, however, that (1) any amendment, modification, waiver or consent that treats or affects a Lender in a materially unequal fashion as compared to all other Lenders shall require the consent of the Lender receiving such unequal treatment; and (2) any amendment, modification, waiver or consent that (i) increases the Commitment Amount or the Pro Rata Share of any Lender, (ii) decreases the principal amount of the Note held by any Lender (other than pursuant to Section 2.1(b)) or the number of shares issuable to any Lender upon the exercise of any Warrant held by such Lender, or (iii) increases the Conversion Price applicable to the conversion of any Note held by a Lender (other than any adjustment pursuant to Section 4 of Schedule II to this Agreement), shall require the consent of the affected Lender.

12.6 Reliance by Lender. All covenants, agreements, representations and warranties made herein by Borrower shall be deemed to be material to and to have been relied upon by each Lender, notwithstanding any investigation by such Lender.

12.7 No Set-Offs by Borrower. All sums payable by Borrower pursuant to this Agreement or any of the other Loan Documents shall be payable without notice or demand and shall be payable in United States Dollars without set-off or reduction of any manner whatsoever.

12.8 Counterparts. This Agreement may be executed in any number of counterparts and by different parties on separate counterparts (including signatures delivered by facsimile or other electronic means), each of which, when executed and delivered, shall be deemed to be an original, and all of which, when taken together, shall constitute but one and the same Agreement.

12.9 Survival. All covenants, representations and warranties made in this Agreement shall continue in full force and effect so long as any Obligations or commitment to fund remain outstanding. The obligations of Borrower to indemnify the Lenders with respect to the expenses, damages, losses, costs and liabilities described in Section 10.3 shall survive until all applicable statute of limitations periods with respect to actions that may be brought against the Lenders have run.

13. Relationship of Parties. Borrower and each Lender acknowledge, understand and agree that the relationship between Borrower, on the one hand, and such Lender, on the other, is, and at all time shall remain solely that of a borrower and lender. Such Lender shall not under any circumstances be construed to be a partner or a joint venturer of Borrower or any of its Affiliates; nor shall such Lender under any circumstances be deemed to be in a relationship of confidence or trust or a fiduciary relationship with Borrower or any of its Affiliates, or to owe any fiduciary duty to Borrower or any of its Affiliates. Such Lender does not undertake or assume any responsibility or duty to Borrower or any of its Affiliates to select, review, inspect, supervise, pass judgment upon or otherwise inform Borrower or any of its Affiliates of any matter in connection with its or their Property, any Collateral held by such Lender or the operations of Borrower or any of its Affiliates. Borrower and each of its Affiliates shall rely entirely on their own judgment with respect to such matters, and any review, inspection, supervision, exercise of judgment or supply of information undertaken or assumed by such Lender in connection with such matters is solely for the protection of such Lender and neither Borrower nor any Affiliate is entitled to rely thereon.

14. CHOICE OF LAW AND VENUE; JURY TRIAL WAIVER. THIS AGREEMENT SHALL BE GOVERNED BY, AND CONSTRUED AND ENFORCED IN ACCORDANCE WITH, THE INTERNAL LAWS OF THE STATE OF CALIFORNIA, WITHOUT REGARD TO PRINCIPLES OF CONFLICTS OF LAWS. EACH OF BORROWER AND LENDER HEREBY SUBMITS TO THE NON-EXCLUSIVE JURISDICTION OF THE STATE AND FEDERAL COURTS LOCATED IN THE

NORTHERN DISTRICT OF CALIFORNIA. BORROWER AND LENDER HEREBY WAIVE THEIR RESPECTIVE RIGHTS TO A JURY TRIAL OF ANY CLAIM OR CAUSE OF ACTION BASED UPON OR ARISING OUT OF ANY OF THE LOAN DOCUMENTS OR ANY OF THE TRANSACTIONS CONTEMPLATED THEREIN, INCLUDING CONTRACT CLAIMS, TORT CLAIMS, BREACH OF DUTY CLAIMS, AND ALL OTHER COMMON LAW OR STATUTORY CLAIMS.

15. Waiver of Conflicts. Each party to this Agreement acknowledges that Cooley LLP (“Cooley”), outside general counsel to the Borrower, has in the past performed and is or may now or in the future represent one or more Lenders or their affiliates in matters unrelated to the transactions contemplated by this Agreement (the “Subordinated Loan Facility”), including representation of such Purchasers or their affiliates in matters of a similar nature to the Subordinated Loan Facility. The applicable rules of professional conduct require that Cooley inform the parties hereunder of this representation and obtain their consent. Cooley has served as outside general counsel to the Borrower and has negotiated the terms of the Loans solely on behalf of the Borrower. The Borrower and each Lender hereby (a) acknowledge that they have had an opportunity to ask for and have obtained information relevant to such representation, including disclosure of the reasonably foreseeable adverse consequences of such representation; (b) acknowledge that with respect to the Subordinated Loan Facility, Cooley has represented solely the Borrower, and not any Lender or any stockholder, director or employee of the Borrower or any Lender; and (c) gives its informed consent to Cooley’s representation of the Borrower in the Subordinated Loan Facility.

[Remainder of page intentionally left blank.]

IN WITNESS WHEREOF, the parties hereto have caused this Agreement to be executed as of the date first above written.

BORROWER:

ENPHASE ENERGY, INC.

By: _____

Name: _____

Title: _____

AGENT AND LENDER:

KPCB HOLDINGS, INC., AS NOMINEE

By: _____

Name: _____

Title: _____

LENDER(S):

[NAME OF LENDER(S)]

By: _____

Name: _____

Title: _____

Terms for Conversion of Outstanding Balance on Advances

1. DEFINITION. The following definitions shall apply for all purposes of this Schedule II to the Agreement:

“Actual Conversion Amount” means the amount of the outstanding balance of a Loan (including for clarity the aggregate outstanding principal and all accrued interest and PIK Interest in respect of such Loan) converted into Conversion Stock pursuant to Section 2 of this Schedule II.

“Actual Conversion Date” means the date on which any of the outstanding balance of a Loan is converted pursuant to Section 2 of this Schedule II.

“Conversion Price” means the lower of (a) \$0.98 or (b) the lowest per share selling price of any shares of capital stock sold by Borrower following the Effective Date, other than shares of capital stock sold in a transaction that would be exempt from the anti-dilution rights of the holders of Borrower’s preferred stock pursuant to clauses (i) through (viii) of Article V, Section 5.8 of Borrower’s certificate of incorporation, as in effect on the Effective Date. The Conversion Price is subject to adjustment as provided herein.

“Conversion Stock” means Borrower’s Common Stock. The number and character of shares of Conversion Stock are subject to adjustment as provided in Section 4 of this Schedule II and the term “Conversion Stock” shall include the stock and other securities and property that are, on the Actual Conversion Date, receivable or issuable upon such conversion of a Note in accordance with Section 4 of this Schedule II.

“Dividend Event” has the meaning set forth in Section 4.2 of this Schedule II.

“Lost Note Documentation” means documentation reasonably satisfactory to Borrower with regard to a lost or stolen Note, including, if required by Borrower, an affidavit of lost note and an indemnification agreement by the respective Lender in favor of Borrower with respect to such lost or stolen Note.

“Maximum Conversion Amount” means:

(a) with respect to any Loan comprising part of the Initial Advance, the amount of the entire outstanding balance of such Loan (including for clarity the aggregate outstanding principal and all accrued interest and PIK Interest in respect of such Loan), and

(b) with respect to any Loan comprising part of a Subsequent Advance, an amount equal to fifty percent (50%) of the initial outstanding principal amount of such Loan plus all accrued interest and PIK Interest in respect of such portion of the principal amount (the outstanding balance of the Initial Advance and convertible portion of the Subsequent Advances being sometimes referred to herein as the “Convertible Portion of the Loans” and the non-convertible portion of the Subsequent Advances being referred to herein as the “Non-Convertible Portion of the Loans”); provided that if the Maturity Date occurs by reason of an IPO and either (i) Borrower is prohibited from paying, (ii) the Lenders are otherwise prohibited from receiving or accepting payment for, or (iii) Borrower otherwise fails to pay when due the outstanding balance on any Subsequent Advance due in connection with the consummation of the IPO, including without limitation by reason of a default or event of default under the Senior Secured Loan and Security Agreement and/or the Senior Subordinated Secured Loan and Security Agreement or the application of the terms of the

Subordination Agreement, then the “Maximum Conversion Amount” with respect to the foregoing clause (b) shall be deemed to be one hundred percent (100%) of the amount of the outstanding balance of such Loans.

“Reorganization Event” has the meaning set forth in Section 4.3 of this Schedule II.

“Stock Event” has the meaning set forth in Section 4.4 of this Schedule II.

2. CONVERSION.

2.1 Optional Conversion Prior to Maturity Date. Upon the election of a Lender with respect to any Loan made by it, which election shall be exercised by written notice from such Lender given to Borrower prior to Borrower’s repayment in full of the outstanding balance of such Loan (which election, in the event the Maturity Date is anticipated to occur due to the consummation of a Change in Control or IPO, may at Lender’s option be made contingent upon the completion of such Change in Control or IPO), the entire Maximum Conversion Amount of such Loan, or any portion thereof as specified in such election of the Lender, shall be cancelled and converted into that number of shares of Conversion Stock obtained by dividing (i) the entire Maximum Conversion Amount of such Loan or portion thereof specified by the Lender, by (ii) the Conversion Price.

2.2 Timing of Conversion; Tender of Note or Addendum Thereto for Conversion. In connection with a conversion pursuant to Section 2.1, a Lender shall deliver the original Note or the applicable addendum thereto corresponding to such Loan (or Lost Note Documentation, if applicable) to Borrower. If a Lender elects to convert only a portion of the Loan represented by a Note or addendum, as the case may be, then promptly after (and in any event within 7 days after) receipt of the original Note or such addendum (or Lost Note Documentation, if applicable) Borrower shall re-issue such Lender a new Note or addendum reflecting the portion of such Loan that was not converted and remains outstanding. If a Lender delivers written notice of an election to convert a Loan (or portion thereof) within the time period specified in Section 2.1, the conversion of such Loan (or portion thereof) into Conversion Stock shall be deemed to occur upon the earlier of (i) the date of such Lender’s written notice (unless the Lender has elected to make conversion of the Loan contingent on the consummation of a Change in Control or IPO) and (ii) immediately prior to the Maturity Date, without regard to whether Lender has then delivered to Borrower the Note(s) corresponding to the Loan so converted (or the Lost Note Documentation where applicable) or executed any other documents.

2.3 Termination of Rights. Except for the right to obtain certificates representing the Conversion Stock under Section 3 below, all rights with respect to a Loan (or portion thereof) converted pursuant this Section 2 shall terminate upon the effective conversion of such Loan (or portion thereof) as provided in Section 2.1 above.

3. CERTIFICATES; NO FRACTIONAL SHARES. Subject to Section 2.2 above, as soon as practicable after conversion of a Loan pursuant to Section 2.1 above, Borrower at its expense will register such shares of Conversion Stock in Borrower’s stockholder register in the name of the applicable Lender and will cause to be issued in the name of such Lender and to be delivered to such Lender, a certificate or certificates for the number of shares of Conversion Stock to which such Lender shall be entitled upon such conversion (bearing such legends as may be required by applicable state and federal securities laws in the opinion of legal counsel of Borrower, by Borrower’s Certificate of Incorporation and Bylaws and by any agreement between Borrower and such Lender), together with any other securities and property to which such Lender is entitled upon such conversion under the terms of such Loan; provided that in the event that the conversion is effected upon an IPO, Borrower may issue uncertificated shares. No fractional shares shall be

issued upon conversion of a Loan. If upon any conversion of a Loan, a fraction of a share would otherwise be issued, then in lieu of such fractional share, Borrower shall pay to the applicable Lender an amount in cash equal to such fraction of a share multiplied by the applicable Conversion Price.

4. ADJUSTMENT PROVISIONS. So long as any of the aggregate balance of the Loans remains outstanding, the number and character of shares of Conversion Stock issuable upon conversion of a Loan upon an Actual Conversion Date and, to the extent set forth in this Section 4, the Conversion Price therefor, are each subject to adjustment upon each occurrence of an adjustment event described in Sections 4.1 through 4.4 below occurring between the Effective Date and such Actual Conversion Date:

4.1 Adjustment for Stock Splits and Stock Dividends. The Conversion Price and the number of shares of Conversion Stock shall each be proportionally adjusted to reflect any stock dividend, stock split, reverse stock split or other similar event affecting the number of outstanding shares of Conversion Stock without the payment of consideration to Borrower therefor at any time before an Actual Conversion Date.

4.2 Adjustment for Other Dividends and Distributions. If Borrower shall make or issue, or shall fix a record date for the determination of eligible holders of its capital stock entitled to receive, a dividend or other distribution payable with respect to the Conversion Stock that is payable in securities of Borrower (other than issuances with respect to which adjustment is made under Section 4.1 or 4.3 of this Schedule II), or in assets (other than cash dividends) (each, a "Dividend Event"), and such dividend or other distribution is actually made, then, and in each such case, a Lender, upon conversion of an Actual Conversion Amount at any time after such Dividend Event, shall receive, in addition to the Conversion Stock issuable upon such conversion of its Note, the securities or other assets that would have been issuable to such Lender had such Lender, immediately prior to such Dividend Event, converted such Actual Conversion Amount into Conversion Stock.

4.3 Adjustment for Consolidation or Merger. If Borrower shall consolidate with or merge into one or more other corporations or other entities (and for clarity the Loans shall not have already been repaid and/or are not being repaid in connection with the consummation of such consolidation or merger), and pursuant to such consolidation or merger stock, other securities or other property is issued or paid to holders of Conversion Stock (each, a "Reorganization Event"), then, and in each such case, a Lender, upon conversion of an Actual Conversion Amount after the consummation of such Reorganization Event, shall be entitled to receive (in lieu of the stock or other securities and property that such Lender would have been entitled to receive under the terms of its Note upon such conversion but for such Reorganization Event), the stock or other securities or property that such Lender would have been entitled to receive upon the consummation of such Reorganization Event if, immediately prior to such Reorganization Event, such Lender had converted such Actual Conversion Amount into Conversion Stock, all subject to further adjustment as provided herein, and the successor corporation or other successor entity in such Reorganization Event shall duly execute and deliver to such Lender a supplement to such Note acknowledging such corporation's or other entity's obligations under such Note; and in each such case, the terms of such Note shall be applicable to the shares of stock or other securities or property receivable upon the conversion of such Note after the consummation of such Reorganization Event.

4.4 Conversion of Stock. In each case not otherwise covered in Section 4.3 above where (i) all the outstanding Conversion Stock is converted, pursuant to the terms of Borrower's Certificate of Incorporation, into other securities or property, or (ii) the Conversion Stock otherwise ceases to exist or to be authorized under Borrower's Certificate of Incorporation (each a "Stock Event"), then Lender, upon conversion of this Note at any time after such Stock Event, shall receive, in lieu of the number of shares of

Conversion Stock that would have been issuable upon conversion of this Note immediately prior to such Stock Event, the stock and other securities and property that Lender would have been entitled to receive upon the Stock Event, if immediately prior to such Stock Event, Lender had converted the Actual Conversion Amount into Conversion Stock.

4.5 Notice of Adjustments. Borrower shall promptly give written notice of each adjustment of the Conversion Price or the number or type of shares of Conversion Stock or other securities or property issuable upon conversion of a Note that is required under this Section 4. The notice shall describe the adjustment or readjustment and show in reasonable detail the facts on which the adjustment or readjustment is based.

4.6 Reservation of Stock. If the number of shares of Conversion Stock or other securities authorized and reserved for issuance upon conversion of the Notes shall not be sufficient to effect the conversion of the aggregate Maximum Conversion Amounts of the Notes, then Borrower shall take such corporate action as may, in the opinion of its counsel, be necessary to increase its authorized but unissued shares of Conversion Stock or other securities issuable upon conversion of the Notes as shall be sufficient for such purpose.

5. REPRESENTATIONS AND WARRANTIES AND COVENANTS OF THE LENDERS

5.1 Purchase for Own Account. Each Lender represents that it is acquiring the Notes, the Warrants, the Conversion Stock and the Common Stock, as the case may be (collectively, the "Securities"), solely for its own account and beneficial interest for investment and not for sale or with a view to distribution of the Securities or any part thereof, has no present intention of selling (in connection with a distribution or otherwise), granting any participation in, or otherwise distributing the same, and does not presently have reason to anticipate a change in such intention. Notwithstanding the foregoing, KPCB Holdings, Inc. is acquiring the Securities as a nominee.

5.2 Information and Sophistication. Without lessening or obviating the representations and warranties of the Borrower set forth in Section 5 of the Loan Agreement, each Lender hereby: (i) acknowledges that it has received all the information it has requested from the Borrower and it considers necessary or appropriate for deciding whether to acquire the Securities, (ii) represents that it has had an opportunity to ask questions and receive answers from the Borrower regarding the terms and conditions of the offering of the Securities and to obtain any additional information necessary to verify the accuracy of the information given the Lender and (iii) further represents that it has such knowledge and experience in financial and business matters that it is capable of evaluating the merits and risk of this investment.

5.3 Ability to Bear Economic Risk. Each Lender acknowledges that investment in the Securities involves a high degree of risk, and represents that it is able, without materially impairing its financial condition, to hold the Securities for an indefinite period of time and to suffer a complete loss of its investment.

5.4 Further Limitations on Disposition. Without in any way limiting the representations set forth above, each Lender further agrees not to make any disposition of all or any portion of the Securities unless and until:

(a) There is then in effect a Registration Statement under the Act covering such proposed disposition and such disposition is made in accordance with such Registration Statement; or

(b) The Lender shall have notified the Borrower of the proposed disposition and shall have furnished the Borrower with a detailed statement of the circumstances surrounding the proposed disposition, and if reasonably requested by the Borrower, such Lender shall have furnished the Borrower with an opinion of counsel, reasonably satisfactory to the Borrower, that such disposition will not require registration under the Act or any applicable state securities laws, provided that no such opinion shall be required for dispositions in compliance with Rule 144, except in unusual circumstances.

Notwithstanding the provisions of paragraphs (a) and (b) above, no such registration statement or opinion of counsel shall be required: (i) for any transfer of any Conversion Stock, Common Stock and shares of Common Stock issued or issuable upon exercise of any Warrant in compliance with SEC Rule 144 or Rule 144A, or (ii) for any transfer of any Conversion Stock, Common Stocker shares of Common Stock issued or issuable upon exercise of any Warrant that is a partnership, limited liability company or corporation to (A) a partner (or retired partner) or member (or retired member) of such Lender in accordance with partnership or limited liability company interests or stock or other equity interests of such entity or (B) an Affiliate of such Lender that is a limited liability company or corporation, or (iii) for any transfers by gift, will or intestate succession to any spouse or lineal descendants or ancestors, if all transferees agree in writing to be subject to the terms hereof to the same extent as if they were Lenders hereunder.

5.5 Accredited Investor Status. Each Lender is an “accredited investor” as such term is defined in Rule 501 under the Act.

5.7 Lock-Up Agreement. Each Lender acknowledges that the Conversion Stock, Common Stock and any shares of Common Stock issued upon exercise of the Warrant held by such Lender shall be bound by the lock-up provisions set forth in Section 1.13 of the Amended and Restated Investors’ Rights Agreement dated as of March 15, 2010 by and between the Borrower and certain investors in the Borrower, to which Lender, or an Affiliate of the Lender, is a party.

[Remainder of Page Intentionally Left Blank]

CERTAIN CONFIDENTIAL INFORMATION CONTAINED IN THIS DOCUMENT, MARKED BY BRACKETS, HAS BEEN OMITTED AND FILED SEPARATELY WITH THE SECURITIES AND EXCHANGE COMMISSION PURSUANT TO RULE 406 OF THE SECURITIES ACT OF 1933, AS AMENDED. CONFIDENTIAL TREATMENT HAS BEEN REQUESTED WITH RESPECT TO THE OMITTED PORTIONS.

SECURED PROMISSORY NOTE

\$ _____

Dated: __ ____, 20[__]

FOR VALUE RECEIVED, the undersigned, ENPHASE ENERGY, INC., a Delaware corporation ("Borrower"), HEREBY PROMISES TO PAY to [____], a [____] ("Lender") the principal amount of [____] Dollars (\$[____]) (the "Loan") made to Borrower by Lender pursuant to the Loan Agreement (as defined below), and to pay all other amounts due with respect to the Loan on the dates and in the amounts set forth in the Loan Agreement.

Interest on the principal amount of this Note from the date of this Note shall accrue at a fixed rate equal to the Loan Rate as set forth herein, or, if applicable, the Default Rate. The Loan Rate for this Note is 9% per annum based on a year of twelve 30-day months, compounding monthly and subject to the terms and conditions of the Loan Agreement. If the Funding Date is not the first day of the month, interim interest accruing from the Funding Date through the last day of that month shall be paid on the first calendar day of the next calendar month. Commencing on the date hereof, through and including ____, 200__, on the [____] day of each month (each an "Interest Payment Date") Borrower shall make payments of accrued interest on the terms and conditions and in the manner set forth in the Loan Agreement; provided that so long as no Event of Default has occurred and is continuing and subject to the immediately succeeding sentence, Borrower shall not be required to pay such interest in cash but instead all such accrued and unpaid interest shall accumulate as PIK Interest and accrete to the outstanding principal balance of any Loans associated with this Note or any addendum or supplement to this Note, as described in the Loan Agreement.

If not sooner paid, all outstanding amounts hereunder and under the Loan Agreement shall become due and payable on the Maturity Date (as defined in the Loan Agreement).

Principal, interest and all other amounts due with respect to the Loan, are payable in lawful money of the United States of America to Lender as set forth in the Loan Agreement. The principal amount of this Note and the interest rate applicable thereto, and all payments made with respect thereto, shall be recorded by Lender and, prior to any transfer hereof, endorsed on the grid attached hereto which is part of this Note.

This Note is referred to in, and is entitled to the benefits of, the Subordinated Convertible Loan Facility and Security Agreement by and among Borrower, KPCB Holdings, Inc., as nominee, as a Lender and as Agent on behalf of and for the ratable benefit of the Lenders, and the other Lenders named therein (as amended, amended and restated, joined, supplemented or otherwise modified from time to time, the "Loan Agreement"). The Loan Agreement, among other things, (a) provides for the making of secured Loans to Borrower, and (b) contains provisions for acceleration of the maturity hereof upon the happening of certain stated events. All capitalized terms used but not defined herein shall have the meaning ascribed to such terms in the Loan Agreement.

This Note and the obligation of Borrower to repay the unpaid principal amount of the Loan, interest on the Loan and all other amounts due Lender under the Loan Agreement is secured under the Loan Agreement.

THIS NOTE IS SUBJECT TO THE TERMS AND CONDITIONS OF THAT CERTAIN SUBORDINATION AGREEMENT (AS DEFINED IN THE LOAN AGREEMENT), AND THE LIEN AND THE SECURITY INTEREST GRANTED UNDER THE LOAN AGREEMENT AND THE RIGHTS TO RECEIVE PAYMENTS, INCLUDING BUT NOT LIMITED TO PIK INTEREST, ARE SUBJECT TO THE TERMS AND CONDITIONS OF THE SUBORDINATION AGREEMENT.

Presentment for payment, demand, notice of protest and all other demands and notices of any kind in connection with the execution, delivery, performance and enforcement of this Note are hereby waived.

Borrower shall pay all reasonable fees and expenses, including, without limitation, reasonable attorneys' fees and costs, incurred by Lender in the enforcement or attempt to enforce any of Borrower's obligations hereunder not performed when due. This Note shall be governed by, and construed and interpreted in accordance with, the laws of the State of California.

IN WITNESS WHEREOF, Borrower has caused this Note to be duly executed by one of its officers thereunto duly authorized on the date hereof.

BORROWER:
ENPHASE ENERGY, INC.

By: _____
Name: _____
Title: _____

LIST OF EXHIBITS AND SCHEDULES

Schedule I	Lenders, Lender Commitment Amounts, Pro Rata Shares and Warrants
Schedule II	Terms for Conversion of Outstanding Balance on Advances
Schedule III	Agent and Agency
Exhibit A	Disclosure Schedule (including <u>Annex I</u> thereto)
Exhibit B	Funding Certificate
Exhibit C	Form of Note
Exhibit D	Form of Legal Opinion
Exhibit E	Form of Officer's Certificate
Exhibit F	Form of Warrant

SCHEDULE I**Lenders, Lender Commitment Amounts, Pro Rata Share and Warrants**

<u>Lender</u>	<u>Aggregate Commitment Amount</u>	<u>Share of Initial Advance</u>	<u>Pro Rata Share (Initial Advance / each Subsequent Advance)</u>	<u>Warrants for Common Stock issued in connection with Initial Advance (No. of Shares)</u>	<u>No. of Shares of Common Stock Purchased in connection with Initial Advance</u>	<u>Purchase Price of Shares of Common Stock Purchased in connection with Initial Advance</u>
KPCB Holdings, Inc., as nominee c/o Kleiner Perkins Caufield & Byers 2750 Sand Hill Road Menlo Park, CA 94025	\$25,000,000.00	\$6,250,000.00	50.00%		1,293,103	\$ 749,999.74
Bay Partners XI, L.P. 490 South California Avenue, Suite 200 Palo Alto, CA 94306	\$ 2,266,696.20	\$ 566,674.05	4.53%		117,242	\$ 68,000.36
Bay Partners XI Parallel Fund, L.P. 490 South California Avenue, Suite 200 Palo Alto, CA 94306	\$ 11,392.00	\$ 2,848.00	0.01%		590	\$ 342.20
Madrone Partners, L.P. 3000 Sand Hill Road Building 1, Suite 150 Menlo Park, CA 94025	\$ 6,145,802.69	\$1,536,450.67	12.29%		317,886	\$ 184,373.88
CalPERS Clean Energy and Technology Fund, LLC c/o Capital Dynamics 2550 Sand Hill Road, Suite #150	\$ 1,755,913.21	\$ 438,978.30	3.51%	90,823		

Menlo Park, CA 94025						
Third Point Partners Qualified LP c/o Third Point LLC 390 Park Ave., 18 th Flr New York, NY 10022	\$ 1,148,790.20	\$ 287,197.55	2.28%	59,420		
Third Point Partners LP c/o Third Point LLC 390 Park Ave., 18 th Flr New York, NY 10022	\$ 694,141.08	\$ 173,535.27	1.39%	35,903		
Third Point Offshore Master Fund, L.P. c/o Third Point LLC 390 Park Ave., 18 th Flr New York, NY 10022	\$ 5,357,293.80	\$ 1,339,323.45	10.71%	277,101		
Third Ultra Master Fund, L.P. c/o Third Point LLC 390 Park Ave., 18 th Flr New York, NY 10022	\$ 743,914.20	\$ 185,978.55	1.49%	38,478		
PCG Clean Energy & Technology Fund (East) LLC 1200 Prospect Street, Suite 200 La Jolla, CA 92037	\$ 877,956.60	\$ 219,489.15	1.76%	45,411	\$ 26,338.38	
Robert Schwartz 1277 Borregas Ave. Sunnyvale, CA 94089	\$ 50,000.00	\$ 12,500.00	0.10%	2,586		
Matthew White Family Trust (Matthew White) c/o G&W Ventures, LLC 201 1st Street, Suite 100 Petaluma, CA 94952	\$ 50,375.00	\$ 12,593.75	0.10%	2,605	\$ 1,511.19	

Matthew White Family Trust (William White) c/o G&W Ventures, LLC 201 1st Street, Suite 100 Petaluma, CA 94952	\$ 50,375.00	\$ 12,593.75	0.10%	2,605	\$ 1,511.19
Tom Birdsall and Rebecca Green 2767 Clay Street San Francisco, CA 94115	\$ 94,600.00	\$ 23,650.00	0.19%	4,893	\$ 2,837.94
Restatement of James H. Carstensen 1995 Revocable Trust dated, March 13, 2000 11904 Harrington St. Bakersfield, CA 93311	\$ 50,000.00	\$ 12,500.00	0.10%	2,586	\$ 1,499.88
Redstone Investments LLC Attn: David Scott P.O Box 1334 Kenwood, CA 95452	\$ 49,550.00	\$ 12,387.50	0.10%	2,562	\$ 1,485.96
John F. Nichols Revocable Trust, under Agreement dated June 12, 1998 6300 N. Sagewood H-102 Park City, UT 84098	\$ 371,100.00	\$ 92,775.00	0.74%	19,194	\$ 11,132.52
TGI Holdings, LLC Attn: Michael B. Targoff 600 Third Avenue	\$ 699,750.00	\$ 174,937.50	1.40%		

New York, NY 10016					36,193	\$ 20,991.94
Donald and Maureen Green Living Trust Donald Green, Trustee 950 Shiloh Vista Santa Rosa, CA 95403	\$ 729,200.00	\$ 182,300.00	1.46%		37,717	\$ 21,875.86
Ellen Schwab 34 Houston Street San Francisco, CA 94133	\$ 96,700.00	\$ 24,175.00	0.19%	5,001		
Timothy Lash 17 Stony Brook Road Darien, CT 06820	\$ 81,350.00	\$ 20,337.50	0.16%	4,207		
Applied Ventures, LLC c/o Applied Materials, Inc. 3050 Bowers Avenue, MS0105 Santa Clara, CA 95054	\$2,442,100.00	\$610,525.00	4.88%	126,315		
Daniel Loeb 390 Park Ave., 18th Floor New York, NY 10022	\$ 706,800.00	\$ 176,700.00	1.41%	36,558		
James A. Stern Trust F/B/O Peter Stern 38 Taylor Lane	\$ 263,100.00	\$ 65,775.00	0.53%			

Harrison, NY 10528				13,608	\$7,892.64
James A. Stern Trust					
F/B/O David Stern					
38 Taylor Lane					
Harrison, NY 10528	\$263,100.00	\$65,775.00	0.53%	13,608	\$7,892.64

SCHEDULE I-A

KPCB Holdings, Inc., as nominee

Bay Partners XI, L.P.

Bay Partners XI Parallel Fund, L.P.

Madrone Partners, L.P.

CalPERS Clean Energy and Technology Fund, LLC

Third Point Partners Qualified LP

Third Point Partners LP

Third Point Offshore Master Fund, L.P.

PCG Clean Energy & Technology Fund LLC

PCG Clean Energy & Technology Fund (East) LLC

Applied Ventures, LLC

SCHEDULE II

Terms for Conversion of Outstanding Balance on Advances

1. DEFINITION. The following definitions shall apply for all purposes of this Schedule II to the Agreement:

“Actual Conversion Amount” means the amount of the outstanding balance of a Loan (including for clarity the aggregate outstanding principal and all accrued interest and PIK Interest in respect of such Loan) converted into Conversion Stock pursuant to Section 2 of this Schedule II.

“Actual Conversion Date” means the date on which any of the outstanding balance of a Loan is converted pursuant to Section 2 of this Schedule II.

“Conversion Price” means the lower of (a) \$0.98 or (b) the lowest per share selling price of any shares of capital stock sold by Borrower following the Effective Date, other than shares of capital stock sold in a transaction that would be exempt from the anti-dilution rights of the holders of Borrower’s preferred stock pursuant to clauses (i) through (viii) of Article V, Section 5.8 of Borrower’s certificate of incorporation, as in effect on the Effective Date. The Conversion Price is subject to adjustment as provided herein.

“Conversion Stock” means Borrower’s Common Stock. The number and character of shares of Conversion Stock are subject to adjustment as provided in Section 4 of this Schedule II and the term “Conversion Stock” shall include the stock and other securities and property that are, on the Actual Conversion Date, receivable or issuable upon such conversion of a Note in accordance with Section 4 of this Schedule II.

“Dividend Event” has the meaning set forth in Section 4.2 of this Schedule II.

“Lost Note Documentation” means documentation reasonably satisfactory to Borrower with regard to a lost or stolen Note, including, if required by Borrower, an affidavit of lost note and an indemnification agreement by the respective Lender in favor of Borrower with respect to such lost or stolen Note.

“Maximum Conversion Amount” means:

(a) with respect to any Loan comprising part of the Initial Advance, the amount of the entire outstanding balance of such Loan (including for clarity the aggregate outstanding principal and all accrued interest and PIK Interest in respect of such Loan), and

(b) with respect to any Loan comprising part of a Subsequent Advance, an amount equal to fifty percent (50%) of the initial outstanding principal amount of such Loan plus all accrued interest and PIK Interest in respect of such portion of the principal amount (the outstanding balance of the Initial Advance and convertible portion of the Subsequent Advances being sometimes referred to herein as the “Convertible Portion of the Loans” and the non-convertible portion of the Subsequent Advances being referred to herein as the “Non-Convertible Portion of the Loans”)); provided that if the Maturity Date occurs by reason of an IPO and either (i) Borrower is prohibited from paying, (ii) the Lenders are otherwise prohibited from receiving or accepting payment for, or (iii) Borrower otherwise fails to pay when due the outstanding balance on any Subsequent Advance due in connection with the consummation of the IPO, including without limitation by reason of a default or event of default under the Senior Secured Loan and Security Agreement and/or the Senior Subordinated Secured Loan and Security

Agreement or the application of the terms of the Subordination Agreement, then the “Maximum Conversion Amount” with respect to the foregoing clause (b) shall be deemed to be one hundred percent (100%) of the amount of the outstanding balance of such Loans.

“Reorganization Event” has the meaning set forth in Section 4.3 of this Schedule II.

“Stock Event” has the meaning set forth in Section 4.4 of this Schedule II.

2. CONVERSION.

2.1 Optional Conversion Prior to Maturity Date. Upon the election of a Lender with respect to any Loan made by it, which election shall be exercised by written notice from such Lender given to Borrower prior to Borrower’s repayment in full of the outstanding balance of such Loan (which election, in the event the Maturity Date is anticipated to occur due to the consummation of a Change in Control or IPO, may at Lender’s option be made contingent upon the completion of such Change in Control or IPO), the entire Maximum Conversion Amount of such Loan, or any portion thereof as specified in such election of the Lender, shall be cancelled and converted into that number of shares of Conversion Stock obtained by dividing (i) the entire Maximum Conversion Amount of such Loan or portion thereof specified by the Lender, by (ii) the Conversion Price.

2.2 Timing of Conversion; Tender of Note or Addendum Thereto for Conversion. In connection with a conversion pursuant to Section 2.1, a Lender shall deliver the original Note or the applicable addendum thereto corresponding to such Loan (or Lost Note Documentation, if applicable) to Borrower. If a Lender elects to convert only a portion of the Loan represented by a Note or addendum, as the case may be, then promptly after (and in any event within 7 days after) receipt of the original Note or such addendum (or Lost Note Documentation, if applicable) Borrower shall re-issue such Lender a new Note or addendum reflecting the portion of such Loan that was not converted and remains outstanding. If a Lender delivers written notice of an election to convert a Loan (or portion thereof) within the time period specified in Section 2.1, the conversion of such Loan (or portion thereof) into Conversion Stock shall be deemed to occur upon the earlier of (i) the date of such Lender’s written notice (unless the Lender has elected to make conversion of the Loan contingent on the consummation of a Change in Control or IPO) and (ii) immediately prior to the Maturity Date, without regard to whether Lender has then delivered to Borrower the Note(s) corresponding to the Loan so converted (or the Lost Note Documentation where applicable) or executed any other documents.

2.3 Termination of Rights. Except for the right to obtain certificates representing the Conversion Stock under Section 3 below, all rights with respect to a Loan (or portion thereof) converted pursuant this Section 2 shall terminate upon the effective conversion of such Loan (or portion thereof) as provided in Section 2.1 above.

3. CERTIFICATES: NO FRACTIONAL SHARES. Subject to Section 2.2 above, as soon as practicable after conversion of a Loan pursuant to Section 2.1 above, Borrower at its expense will register such shares of Conversion Stock in Borrower’s stockholder register in the name of the applicable Lender and will cause to be issued in the name of such Lender and to be delivered to such Lender, a certificate or certificates for the number of shares of Conversion Stock to which such Lender shall be entitled upon such conversion (bearing such legends as may be required by applicable state and federal securities laws in the opinion of legal counsel of Borrower, by Borrower’s Certificate of Incorporation and Bylaws and by any agreement between Borrower and such Lender), together with any other securities and property to which such Lender is entitled upon such conversion under the terms of such Loan; provided that in the event that the conversion is effected upon an IPO, Borrower may issue uncertificated shares. No fractional shares shall be issued upon conversion of a Loan. If upon any conversion of a

Loan, a fraction of a share would otherwise be issued, then in lieu of such fractional share, Borrower shall pay to the applicable Lender an amount in cash equal to such fraction of a share multiplied by the applicable Conversion Price.

4. ADJUSTMENT PROVISIONS. So long as any of the aggregate balance of the Loans remains outstanding, the number and character of shares of Conversion Stock issuable upon conversion of a Loan upon an Actual Conversion Date and, to the extent set forth in this Section 4, the Conversion Price therefor, are each subject to adjustment upon each occurrence of an adjustment event described in Sections 4.1 through 4.4 below occurring between the Effective Date and such Actual Conversion Date:

4.1 Adjustment for Stock Splits and Stock Dividends. The Conversion Price and the number of shares of Conversion Stock shall each be proportionally adjusted to reflect any stock dividend, stock split, reverse stock split or other similar event affecting the number of outstanding shares of Conversion Stock without the payment of consideration to Borrower therefor at any time before an Actual Conversion Date.

4.2 Adjustment for Other Dividends and Distributions. If Borrower shall make or issue, or shall fix a record date for the determination of eligible holders of its capital stock entitled to receive, a dividend or other distribution payable with respect to the Conversion Stock that is payable in securities of Borrower (other than issuances with respect to which adjustment is made under Section 4.1 or 4.3 of this Schedule II), or in assets (other than cash dividends) (each, a "Dividend Event"), and such dividend or other distribution is actually made, then, and in each such case, a Lender, upon conversion of an Actual Conversion Amount at any time after such Dividend Event, shall receive, in addition to the Conversion Stock issuable upon such conversion of its Note, the securities or other assets that would have been issuable to such Lender had such Lender, immediately prior to such Dividend Event, converted such Actual Conversion Amount into Conversion Stock.

4.3 Adjustment for Consolidation or Merger. If Borrower shall consolidate with or merge into one or more other corporations or other entities (and for clarity the Loans shall not have already been repaid and/or are not being repaid in connection with the consummation of such consolidation or merger), and pursuant to such consolidation or merger stock, other securities or other property is issued or paid to holders of Conversion Stock (each, a "Reorganization Event"), then, and in each such case, a Lender, upon conversion of an Actual Conversion Amount after the consummation of such Reorganization Event, shall be entitled to receive (in lieu of the stock or other securities and property that such Lender would have been entitled to receive under the terms of its Note upon such conversion but for such Reorganization Event), the stock or other securities or property that such Lender would have been entitled to receive upon the consummation of such Reorganization Event if, immediately prior to such Reorganization Event, such Lender had converted such Actual Conversion Amount into Conversion Stock, all subject to further adjustment as provided herein, and the successor corporation or other successor entity in such Reorganization Event shall duly execute and deliver to such Lender a supplement to such Note acknowledging such corporation's or other entity's obligations under such Note; and in each such case, the terms of such Note shall be applicable to the shares of stock or other securities or property receivable upon the conversion of such Note after the consummation of such Reorganization Event.

4.4 Conversion of Stock. In each case not otherwise covered in Section 4.3 above where (i) all the outstanding Conversion Stock is converted, pursuant to the terms of Borrower's Certificate of Incorporation, into other securities or property, or (ii) the Conversion Stock otherwise ceases to exist or to be authorized under Borrower's Certificate of Incorporation (each a "Stock Event"), then Lender, upon conversion of this Note at any time after such Stock Event, shall receive, in lieu of the number of shares of Conversion Stock that would have been issuable upon conversion of this Note immediately prior to such Stock Event, the stock and other securities and property that Lender would

have been entitled to receive upon the Stock Event, if immediately prior to such Stock Event, Lender had converted the Actual Conversion Amount into Conversion Stock.

4.5 Notice of Adjustments. Borrower shall promptly give written notice of each adjustment of the Conversion Price or the number or type of shares of Conversion Stock or other securities or property issuable upon conversion of a Note that is required under this Section 4. The notice shall describe the adjustment or readjustment and show in reasonable detail the facts on which the adjustment or readjustment is based.

4.6 Reservation of Stock. If the number of shares of Conversion Stock or other securities authorized and reserved for issuance upon conversion of the Notes shall not be sufficient to effect the conversion of the aggregate Maximum Conversion Amounts of the Notes, then Borrower shall take such corporate action as may, in the opinion of its counsel, be necessary to increase its authorized but unissued shares of Conversion Stock or other securities issuable upon conversion of the Notes as shall be sufficient for such purpose.

5. REPRESENTATIONS AND WARRANTIES AND COVENANTS OF THE LENDERS

5.1 Purchase for Own Account. Each Lender represents that it is acquiring the Notes, the Warrants, the Conversion Stock and the Common Stock, as the case may be (collectively, the "Securities"), solely for its own account and beneficial interest for investment and not for sale or with a view to distribution of the Securities or any part thereof, has no present intention of selling (in connection with a distribution or otherwise), granting any participation in, or otherwise distributing the same, and does not presently have reason to anticipate a change in such intention. Notwithstanding the foregoing, KPCB Holdings, Inc. is acquiring the Securities as a nominee.

5.2 Information and Sophistication. Without lessening or obviating the representations and warranties of the Borrower set forth in Section 5 of the Loan Agreement, each Lender hereby: (i) acknowledges that it has received all the information it has requested from the Borrower and it considers necessary or appropriate for deciding whether to acquire the Securities, (ii) represents that it has had an opportunity to ask questions and receive answers from the Borrower regarding the terms and conditions of the offering of the Securities and to obtain any additional information necessary to verify the accuracy of the information given the Lender and (iii) further represents that it has such knowledge and experience in financial and business matters that it is capable of evaluating the merits and risk of this investment.

5.3 Ability to Bear Economic Risk. Each Lender acknowledges that investment in the Securities involves a high degree of risk, and represents that it is able, without materially impairing its financial condition, to hold the Securities for an indefinite period of time and to suffer a complete loss of its investment.

5.4 Further Limitations on Disposition. Without in any way limiting the representations set forth above, each Lender further agrees not to make any disposition of all or any portion of the Securities unless and until:

(a) There is then in effect a Registration Statement under the Act covering such proposed disposition and such disposition is made in accordance with such Registration Statement; or

(b) The Lender shall have notified the Borrower of the proposed disposition and shall have furnished the Borrower with a detailed statement of the circumstances surrounding the proposed disposition, and if reasonably requested by the Borrower, such Lender shall have furnished the

Borrower with an opinion of counsel, reasonably satisfactory to the Borrower, that such disposition will not require registration under the Act or any applicable state securities laws, provided that no such opinion shall be required for dispositions in compliance with Rule 144, except in unusual circumstances.

Notwithstanding the provisions of paragraphs (a) and (b) above, no such registration statement or opinion of counsel shall be required: (i) for any transfer of any Conversion Stock, Common Stock and shares of Common Stock issued or issuable upon exercise of any Warrant in compliance with SEC Rule 144 or Rule 144A, or (ii) for any transfer of any Conversion Stock, Common Stocker shares of Common Stock issued or issuable upon exercise of any Warrant that is a partnership, limited liability company or corporation to (A) a partner (or retired partner) or member (or retired member) of such Lender in accordance with partnership or limited liability company interests or stock or other equity interests of such entity or (B) an Affiliate of such Lender that is a limited liability company or corporation, or (iii) for any transfers by gift, will or intestate succession to any spouse or lineal descendants or ancestors, if all transferees agree in writing to be subject to the terms hereof to the same extent as if they were Lenders hereunder.

5.5 Accredited Investor Status. Each Lender is an “accredited investor” as such term is defined in Rule 501 under the Act.

5.7 Lock-Up Agreement. Each Lender acknowledges that the Conversion Stock, Common Stock and any shares of Common Stock issued upon exercise of the Warrant held by such Lender shall be bound by the lock-up provisions set forth in Section 1.13 of the Amended and Restated Investors’ Rights Agreement dated as of March 15, 2010 by and between the Borrower and certain investors in the Borrower, to which Lender, or an Affiliate of the Lender, is a party.

[Remainder of Page Intentionally Left Blank]

SCHEDULE III

Terms relating to Agent and Agency

Each of the Lenders hereby irrevocably appoints the Agent as its agent and authorizes the Agent to take such actions on its behalf and to exercise such powers as are delegated to such Agent by the terms of the Loan Documents, together with such actions and powers as are reasonably incidental thereto. Without limiting the generality of the foregoing, the Agent is hereby expressly authorized to execute, and thereby to bind each Lender to, (i) any and all documents (including releases) with respect to the Collateral and the rights of the Secured Parties with respect thereto, as contemplated by and in accordance with the provisions of this Agreement and the Loan Documents and (ii) the Subordination Agreement.

The person serving as the Agent hereunder shall have the same rights and powers in its capacity as a Lender as any other Lender and may exercise the same as though it were not an Agent, and such person and its affiliates may provide debt financing, equity capital or other services (including financial advisory services) to any of the Lenders (or any person engaged in similar business as that engaged in by any of the Lenders) as if such person was not performing the duties specified herein, and may accept fees and other consideration from any of the Lenders for services in connection with this Agreement and otherwise without having to account for the same to the Lenders.

Agent shall not have any duties or obligations except those expressly set forth in the Loan Documents. Without limiting the generality of the foregoing, (a) Agent shall not be subject to any fiduciary or other implied duties, regardless of whether a Default has occurred and is continuing, (b) Agent shall not have any duty to take any discretionary action or exercise any discretionary powers, except discretionary rights and powers expressly contemplated hereby that such Agent is instructed in writing to exercise by the Required Lenders, and (c) except as expressly set forth in the Loan Documents, Agent shall not have any duty to disclose, nor shall it be liable for the failure to disclose, any information relating to Borrower or any of the Subsidiaries that is communicated to or obtained by the person serving as Agent and/or Collateral Agent or any of its Affiliates in any capacity. Agent shall not be liable for any action taken or not taken by it with the consent or at the request of the Required Lenders or in the absence of its own gross negligence or willful misconduct. Agent shall not be deemed to have knowledge of any Default unless and until written notice thereof is given to such Agent by Borrower or a Lender, and Agent shall not be responsible for or have any duty to ascertain or inquire into (i) any statement, warranty or representation made in or in connection with any Loan Document, (ii) the contents of any certificate, report or other document delivered thereunder or in connection therewith, (iii) the performance or observance of any of the covenants, agreements or other terms or conditions set forth in any Loan Document, (iv) the validity, enforceability, effectiveness or genuineness of any Loan Document or any other agreement, instrument or document, or (v) the satisfaction of any condition set forth in Section 3 of the Loan Agreement or elsewhere in any Loan Document, other than to confirm receipt of items expressly required to be delivered to such Agent.

Agent shall be entitled to rely upon, and shall not incur any liability for relying upon, any notice, request, certificate, consent, statement, instrument, document or other writing believed by it to be genuine and to have been signed or sent by the proper person. Agent may also rely upon any statement made to it orally or by telephone and believed by it to have been made by the proper person, and shall not incur any liability for relying thereon. Agent may consult with legal counsel (who may be counsel for the Borrower), independent accountants and other experts selected by it, and shall not be liable for any action taken or not taken by it in accordance with the advice of any such counsel, accountants or experts.

Agent may perform any and all its duties and exercise its rights and powers by or through any one or more sub-agents appointed by it. Agent and any such sub-agent may perform any and all its duties and

exercise its rights and powers by or through their respective Affiliates. The exculpatory provisions of the preceding paragraphs shall apply to any such sub-agent and to the Affiliates of each Agent and any such sub-agent, and shall apply to their respective activities in connection with the syndication of the Credit Facilities as well as activities as Agent.

Subject to the appointment and acceptance of a successor Agent as provided below, Agent may resign at any time by notifying the Lenders and the Borrower. Upon any such resignation, if no Event of Default has occurred and is continuing, with the consent of the Borrower which shall not be unreasonably conditioned, withheld or delayed, the Required Lenders shall have the right, to appoint a successor. If no successor shall have been so appointed by the Required Lenders and shall have accepted such appointment within 30 days after the retiring Agent gives notice of its resignation, then the retiring Agent may, on behalf of the Lenders, appoint a successor Agent which shall be one of the other Lenders under this Agreement, or an Affiliate of any such Lender. Upon the acceptance of its appointment as Agent hereunder by a successor, such successor shall succeed to and become vested with all the rights, powers, privileges and duties of the retiring Agent, and the retiring Agent shall be discharged from its duties and obligations hereunder. The Borrower shall pay the reasonable fees of a successor Agent. After an Agent's resignation hereunder, the provisions of this Schedule III shall continue in effect for the benefit of such retiring Agent, its sub-agents and their respective Affiliates in respect of any actions taken or omitted to be taken by any of them while acting as Agent.

Each Lender acknowledges that it has, independently and without reliance upon the Agent or any other Lender and based on such documents and information as it has deemed appropriate, made its own credit analysis and decision to enter into this Agreement. Each Lender also acknowledges that it will, independently and without reliance upon the Agent or any other Lender and based on such documents and information as it shall from time to time deem appropriate, continue to make its own decisions in taking or not taking action under or based upon this Agreement or any other Loan Document, any related agreement or any document furnished hereunder or thereunder.

Each Lender hereby further authorizes Agent, on behalf of and for the ratable benefit of Lenders, to enter into each Loan Document as secured party and to be the agent for and representative of Lenders thereunder, and each Lender agrees to be bound by the terms of each Loan Document; provided that Agent shall not (i) enter into or consent to any material amendment, modification, termination or waiver of any provision contained in any Loan Document or (ii) release any Collateral (except as otherwise expressly permitted or required pursuant to the terms of this Agreement or the applicable Loan Document), in each case without the prior consent of Required Lenders; provided further, however, that, without further written consent or authorization from Lenders, Agent may execute any documents or instruments necessary to (a) release any Lien encumbering any item of Collateral that is the subject of a sale or other disposition of assets permitted by this Agreement or to which Required Lenders have otherwise consented, or (b) subordinate the Liens of Agent, on behalf of Lenders, to any Liens permitted by the definition of Permitted Liens (other than those Liens which are the subject of the Subordination Agreement). Anything contained in any of the Loan Documents to the contrary notwithstanding, Borrower, Agent and each Lender hereby agree that (1) no Lender shall have any right individually to realize upon any of the Collateral under or otherwise enforce any Loan Document, it being understood and agreed that all powers, rights and remedies under the Loan Documents may be exercised solely by Agent for the ratable benefit of Lenders in accordance with the terms thereof, and (2) in the event of a foreclosure by Agent on any of the Collateral pursuant to a public or private sale, Agent or any Lender may be the purchaser of any or all of such Collateral at any such sale and Agent, as agent for and representative of Lenders (but not any Lender or Lenders in its or their respective individual capacities unless Required Lenders shall otherwise agree in writing) shall be entitled, for the purpose of bidding and making settlement or payment of the purchase price for all or any portion of the Collateral sold at any

such public sale, to use and apply any of the Obligations as a credit on account of the purchase price for any Collateral payable by Agent at such sale.

EXHIBIT B

FUNDING CERTIFICATE

The undersigned, being the duly elected and acting [_____] of ENPHASE ENERGY, INC., a Delaware corporation (“Borrower”), does hereby certify to (i) KPCB HOLDINGS, INC., AS NOMINEE (“KPCB”), as agent on behalf of and for the ratable benefit of the Lenders (“Agent”) under that certain Subordinated Convertible Loan Facility and Security Agreement dated as of [_____] 2011 by and among Borrower, KPCB, as Agent and a Lender, and the other Lenders named therein and party thereto (the “Loan Agreement”; with other capitalized terms used below having the meanings ascribed thereto in the Loan Agreement) and (ii) to each of the Lenders that as of the date hereof and as of the Funding Date:

1. The representations and warranties made by Borrower in Section 5 of the Loan Agreement and in the other Loan Documents are true and correct in all material respects as of the date hereof.
2. No event or condition has occurred that would constitute a Default or an Event of Default under the Loan Agreement or any other Loan Document.
3. Borrower is in compliance with the covenants and requirements contained in Sections 4, 6 and 7 of the Loan Agreement.
4. All conditions referred to in Section 3 of the Loan Agreement to the making of the Loan to be made on or about the date hereof have been satisfied.
5. As of the [date hereof] [date of the most recently ended fiscal quarter], Borrower’s Gross Profit for the period of two consecutive quarters most recently ended (the “Applicable Two Fiscal Quarter Period”) is \$[_____]. The minimum Gross Profit required by the Loan Agreement for the Applicable Two Fiscal Quarter Period is \$[_____]. Borrower is in compliance with this requirement.
6. As of the date hereof, the Warranty Claim Rate for microinverters shipped by or on behalf of Borrower during both (i) the three (3) month and (ii) six (6) month period ending the day immediately preceding the date of this certificate is [__]%. The Loan Agreement requires that such percentage be no greater than 1%. Borrower is in compliance with this requirement.
7. The gross amount of the Advance requested hereby is: \$_____. The proceeds for the Advance shall be disbursed as follows:

Total disbursements from the Lenders:	
Loan Amount	\$ [_____]
Less:	
Lenders Legal Fees	\$
Net Proceeds due from the Lenders:	\$

8. The aggregate net proceeds of the Advance in the amount of \$_____ shall be transferred to Borrower's account as follows:

Account Name: Enphase Energy, Inc
Bank Name: Bridge Bank, N.A.
Bank Address: 55 Almaden Blvd
San Jose, CA95113

Account Number:
ABA Number:

Dated: _____, 2011

BORROWER:
ENPHASE ENERGY, INC.

By: _____

Name: _____

Title: _____

EXHIBIT C

SECURED PROMISSORY NOTE

\$ _____

Dated: _____, 20[___]

FOR VALUE RECEIVED, the undersigned, ENPHASE ENERGY, INC., a Delaware corporation ("Borrower"). HEREBY PROMISES TO PAY to [____], a [____] ("Lender") the principal amount of [____] Dollars (\$[____]) (the "Loan") made to Borrower by Lender pursuant to the Loan Agreement (as defined below), and to pay all other amounts due with respect to the Loan on the dates and in the amounts set forth in the Loan Agreement.

Interest on the principal amount of this Note from the date of this Note shall accrue at a fixed rate equal to the Loan Rate as set forth herein, or, if applicable, the Default Rate. The Loan Rate for this Note is 9% per annum based on a year of twelve 30-day months, compounding monthly and subject to the terms and conditions of the Loan Agreement. If the Funding Date is not the first day of the month, interim interest accruing from the Funding Date through the last day of that month shall be paid on the first calendar day of the next calendar month. Commencing on the date hereof, through and including _____, 200__, on the [____] day of each month (each an "Interest Payment Date") Borrower shall make payments of accrued interest on the terms and conditions and in the manner set forth in the Loan Agreement; provided that so long as no Event of Default has occurred and is continuing and subject to the immediately succeeding sentence, Borrower shall not be required to pay such interest in cash but instead all such accrued and unpaid interest shall accumulate as PIK Interest and accrete to the outstanding principal balance of any Loans associated with this Note or any addendum or supplement to this Note, as described in the Loan Agreement.

If not sooner paid, all outstanding amounts hereunder and under the Loan Agreement shall become due and payable on the Maturity Date (as defined in the Loan Agreement).

Principal, interest and all other amounts due with respect to the Loan, are payable in lawful money of the United States of America to Lender as set forth in the Loan Agreement. The principal amount of this Note and the interest rate applicable thereto, and all payments made with respect thereto, shall be recorded by Lender and, prior to any transfer hereof, endorsed on the grid attached hereto which is part of this Note.

This Note is referred to in, and is entitled to the benefits of, the Subordinated Convertible Loan Facility and Security Agreement by and among Borrower, KPCB Holdings, Inc., as nominee, as a Lender and as Agent on behalf of and for the ratable benefit of the Lenders, and the other Lenders named therein (as amended, amended and restated, joined, supplemented or otherwise modified from time to time, the "Loan Agreement"). The Loan Agreement, among other things, (a) provides for the making of secured Loans to Borrower, and (b) contains provisions for acceleration of the maturity hereof upon the happening of certain stated events. All capitalized terms used but not defined herein shall have the meaning ascribed to such terms in the Loan Agreement.

This Note and the obligation of Borrower to repay the unpaid principal amount of the Loan, interest on the Loan and all other amounts due Lender under the Loan Agreement is secured under the Loan Agreement.

THIS NOTE IS SUBJECT TO THE TERMS AND CONDITIONS OF THAT CERTAIN SUBORDINATION AGREEMENT (AS DEFINED IN THE LOAN AGREEMENT), AND THE LIEN AND THE SECURITY INTEREST GRANTED UNDER THE LOAN AGREEMENT AND THE RIGHTS TO RECEIVE PAYMENTS, INCLUDING BUT NOT LIMITED TO PIK INTEREST, ARE SUBJECT TO THE TERMS AND CONDITIONS OF THE SUBORDINATION AGREEMENT.

Presentment for payment, demand, notice of protest and all other demands and notices of any kind in connection with the execution, delivery, performance and enforcement of this Note are hereby waived.

Borrower shall pay all reasonable fees and expenses, including, without limitation, reasonable attorneys' fees and costs, incurred by Lender in the enforcement or attempt to enforce any of Borrower's obligations hereunder not performed when due. This Note shall be governed by, and construed and interpreted in accordance with, the laws of the State of California.

IN WITNESS WHEREOF, Borrower has caused this Note to be duly executed by one of its officers thereunto duly authorized on the date hereof.

BORROWER:
ENPHASE ENERGY, INC.

By: _____

Name: _____

Title: _____

EXHIBIT D

FORM OF LEGAL OPINION OF BORROWER'S COUNSEL

EXHIBIT E

FORM OF OFFICER'S CERTIFICATE

TO: KPCP Holdings, Inc., as nominee, as Agent for the Lenders under the Loan Agreement

Reference is made to the SUBORDINATED CONVERTIBLE LOAN FACILITY AND SECURITY AGREEMENT dated as of [_____], 2011 (as it may be amended, amended and restated, joined, supplemented or otherwise modified from time to time, the "Loan Agreement") by and among ENPHASE ENERGY, INC. ("Borrower"), KPCB Holdings, Inc., as nominee, a Delaware corporation ("KPCB"), as a Lender hereunder and in its capacity as Agent on behalf of the Lenders hereunder, and the other Persons named herein or who may become parties hereto (together with KPCB, referred to herein individually as a "Lender" and collectively as the "Lenders"), as Lenders, in accordance with the terms of this Agreement. Unless otherwise defined herein, capitalized terms have the meanings given such terms in the Loan Agreement.

The undersigned Responsible Officer of Borrower hereby certifies to Agent on behalf of and for the ratable benefit of the Lenders that:

1. No Event of Default has occurred under the Loan Agreement. (If an Event of Default has occurred, specify the nature and extent thereof and the action Borrower proposes to take with respect thereto.)
2. The information provided in Section 1 of the Disclosure Schedule is currently true and accurate, except as noted below.
3. Borrower is in compliance with the provisions of Sections 4, 6 and 7 of the Loan Agreement, except as noted below.
4. Attached herewith are the [monthly financial statements pursuant to Section 6.3(a) of the Loan Agreement/annual audited financial statements pursuant to Section 6.3(b) of the Loan Agreement]. These have been prepared in accordance with GAAP and are consistent from one period to the next except as noted below.

NOTES TO ABOVE CERTIFICATIONS:

BORROWER:

ENPHASE ENERGY, INC.

By: _____
Name: _____
Title: _____

ENPHASE ENERGY, INC.

EXECUTIVE SEVERANCE AGREEMENT

This Executive Severance Agreement (the "**Agreement**") is dated as of June 14, 2011, by and between Paul B. Nahi ("**Executive**") and Enphase Energy, Inc., a Delaware corporation (the "**Company**"). This Agreement is intended to provide Executive with certain benefits described herein upon the occurrence of specific events.

RECITALS

A. The Company's Board of Directors (the "**Board**") believes it is in the best interests of the Company and its stockholders to retain Executive and provide incentives to Executive to continue in the service of the Company.

B. The Board further believes that it is imperative to provide Executive with certain benefits upon termination of Executive's employment, which benefits are intended to provide Executive with financial security and provide sufficient income and encouragement to Executive to remain with the Company.

C. To accomplish the foregoing objectives, the Board has directed the Company, upon execution of this Agreement by Executive, to agree to the terms provided in this Agreement.

Now therefore, in consideration of the mutual promises, covenants and agreements contained herein, and in consideration of the continuing employment of Executive by the Company, the parties hereto agree as follows:

1. At-Will Employment. Executive's employment is at-will, which means that the Company may terminate Executive's employment at any time, with or without advance notice, and with or without Cause. Similarly, Executive may resign Executive's employment at any time, with or without advance notice or Good Reason. Executive shall not receive any compensation of any kind, including, without limitation, equity award vesting acceleration and severance benefits, following Executive's last day of employment with the Company, except as expressly provided herein. Executive shall devote all reasonable efforts to the performance of Executive's duties, and shall perform such duties in good faith.

2. Benefits Upon Termination of Employment. If Executive's employment is terminated without Cause (and other than as a result of Executive's death or disability) or Executive resigns for Good Reason, and provided such termination constitutes a "separation from service" (within the meaning of Treasury Regulation Section 1.409A-1(h), a "**Separation from Service**"), and provided Executive signs and allows to become effective a release substantially in the form attached hereto as **EXHIBIT A OR EXHIBIT B**, as applicable (the "**Release**") within the time period provided therein, then the Company shall provide Executive with the following severance benefits (the "**Separation Benefits**"):

1.

(a) The Company shall pay Executive an amount equal to six (6) months of Executive's then current base salary, ignoring any decrease in base salary that forms the basis for Good Reason, less all applicable withholdings and deductions, paid over such 6-month period (the "**Salary Continuation**"). The Salary Continuation will be paid in equal installments on the Company's regular payroll schedule and will be subject to applicable tax withholdings over the period outlined above following the date of Executive's Separation from Service as set forth in Section 3 below.

(b) Should Executive elect to continue his health insurance benefits pursuant to the Consolidated Omnibus Budget Reconciliation Act of 1985 ("**COBRA**") and any analogous provisions of applicable state law, the Company shall pay Executive's COBRA group health insurance premiums for Executive and his eligible dependents for a period of six (6) months following the effective date of such termination of employment described in Section 2(a) (the "**COBRA Payment Period**"). References to COBRA premiums shall not include any amounts payable by Executive under an Internal Revenue Code Section 125 health care reimbursement plan. Notwithstanding the foregoing, if the Company determines, in its sole discretion, that the Company cannot provide the COBRA premium benefits without potentially incurring financial costs or penalties under applicable law (including, without limitation, Section 2716 of the Public Health Service Act), the Company shall in lieu thereof pay Executive a taxable cash amount, which payment shall be made regardless of whether Executive or Executive's eligible family members elect health care continuation coverage (the "**Health Care Benefit Payment**"). The Health Care Benefit Payment shall be paid in monthly installments on the same schedule that the COBRA Premiums would otherwise have been paid to the insurer. The Health Care Benefit Payment shall be equal to the amount that the Company would have otherwise paid for COBRA insurance premiums (which amount shall be calculated based on the premium for the first month of coverage), and shall be paid until the expiration of the COBRA Payment Period.

(c) The vesting and/or exercisability of any outstanding equity awards held by Executive at the time of Executive's Separation from Service shall be accelerated as to 25% of the then unvested portions of such outstanding equity awards as of the date of Executive's Separation from Service, provided however that if Executive's Separation from Service occurs in connection with or within twenty four (24) months following a Change in Control, such equity awards shall be accelerated as to 100% of the then unvested portions of such awards. Further, unless otherwise restricted by the Plan and subject to the maximum term of each equity award as set forth in the applicable equity award agreement, each vested and unexercised equity award shall remain exercisable for a period of twelve (12) months following Executive's Separation from Service.

3. Limitations And Conditions On Separation Benefits

(a) **Release Prior to Payment of Benefits.** Prior to the payment of any of the Separation Benefits, Executive shall execute, and allow to become effective, the Release within the time frame set forth therein, but not later than sixty (60) days following Executive's Separation from Service (the "**Release Effective Date**"). Such Release shall specifically relate to all of Executive's rights and claims in existence at the time of such execution and shall confirm Executive's continuing obligations to the Company (including but not limited to obligations under any confidentiality and/or non-solicitation agreement with the Company). No Separation

Benefits will be paid prior to the Release Effective Date. Within five (5) days following the Release Effective Date, the Company will pay Executive the Separation Benefits Executive would otherwise have received on or prior to such date but for the delay in payment related to the effectiveness of the Release, with the balance of the benefits being paid as originally scheduled. Unless a Separation from Service has occurred, the Board, in its sole discretion, may modify the form of the required Release to comply with applicable law and shall determine the form of the required Release, which may be incorporated into a termination agreement or other agreement with Executive. Notwithstanding the foregoing, if the Company (or, if applicable, the successor entity thereto) determines that any of the Separation Benefits constitute “deferred compensation” under Section 409A (defined below), then, solely to the extent necessary to avoid the incurrence of the adverse personal tax consequences under Section 409A, no Separation Benefits will be paid prior to the sixtieth (60th) day following Executive’s Separation from Service. On the sixtieth (60th) day following the date of Separation from Service, the Company will pay to Executive in a lump sum the applicable Separation Benefits that Employee would otherwise have received on or prior to such date, with the balance of the Separation Benefits being paid as originally scheduled.

(b) Income and Employment Taxes. Executives agrees that Executive shall be responsible for any applicable taxes of any nature (including any penalties or interest that may apply to such taxes) that the Company reasonably determines apply to any payment made hereunder, that Executive’s receipt of any benefit hereunder is conditioned on Executive’s satisfaction of any applicable withholding or similar obligations that apply to such benefit, and that any cash payment owed hereunder will be reduced to satisfy any such withholding or similar obligations that may apply.

(c) Compliance with Section 409A. It is intended that each installment of the payments and benefits provided for in this Agreement is a separate “payment” for purposes of Treasury Regulation Section 1.409A-2(b)(2)(i). For the avoidance of doubt, it is intended that payments of the amounts set forth in this Agreement satisfy, to the greatest extent possible, the exemptions from the application of Section 409A of the Internal Revenue Code of 1986, as amended (the “Code”) (Section 409A of the Code, together, with any state law of similar effect, “Section 409A”) provided under Treasury Regulations 1.409A-1(b)(4), 1.409A-1(b)(5) and 1.409A-1(b)(9). However, if the Company (or, if applicable, the successor entity thereto) determines that the severance payments and benefits provided under this Agreement (the “Agreement Payments”) constitute “deferred compensation” under Section 409A and Executive is, on the date of his Separation from Service, a “specified Executive” of the Company or any successor entity thereto, as such term is defined in Section 409A(a)(2)(B)(i) of the Code (a “Specified Executive”), then, solely to the extent necessary to avoid the incurrence of the adverse personal tax consequences under Section 409A, the timing of the Separation Benefit described in Section 2(a) shall be delayed as follows: on the earlier to occur of (i) the date that is six months and one day after Executive’s Separation from Service or (ii) the date of Executive’s death (such earlier date, the “Delayed Initial Payment Date”), the Company (or the successor entity thereto, as applicable) shall pay to Executive a lump sum amount equal to the applicable benefit that Executive would otherwise have received through the Delayed Initial Payment Date if the commencement of the payment of the benefit had not been so delayed pursuant to this Section 3(c).

(d) Conflicts. Executive represents that his performance of all the terms of this Agreement will not breach any other agreement to which Executive is a party. Executive has not, and will not during the term of this Agreement, enter into any oral or written agreement in conflict with any of the provisions of this Agreement. Executive further represents that Executive is entering into or has entered into an employment relationship with the Company of his own free will and that Executive has not been solicited as an employee in any way by the Company.

(e) Successors. Any successor to the Company (whether direct or indirect and whether by purchase, lease, merger, consolidation, liquidation or otherwise) to all or substantially all of the Company's business and/or assets shall assume the obligations under this Agreement and agree expressly to perform the obligations under this Agreement in the same manner and to the same extent as the Company would be required to perform such obligations in the absence of a succession. The terms of this Agreement and all of Executive's rights hereunder and thereunder shall inure to the benefit of, and be enforceable by, Executive's personal or legal representatives, executors, administrators, successors, heirs, distributees, devisees and legatees.

(f) Notice. Notices and all other communications contemplated by this Agreement shall be in writing and shall be deemed to have been duly given when personally delivered or when mailed by U.S. registered or certified mail, return receipt requested and postage prepaid. Mailed notices to Executive shall be addressed to Executive at the home address which Executive most recently communicated to the Company in writing. In the case of the Company, mailed notices shall be addressed to its corporate headquarters, and all notices shall be directed to the attention of its Chief Financial Officer.

4. Definitions.

(a) Cause. For purposes of this Agreement, "**Cause**", as determined by the Board acting in good faith and based on information then known to it, means: (A) gross negligence or willful misconduct in the performance of duties to the Company where such gross negligence or willful misconduct has resulted or is likely to result in substantial and material damage to the Company or its subsidiaries; (B) a material failure to comply with the Company's written policies after having received from the Company notice of, and a reasonable time to cure, such failure; (C) repeated unexplained or unjustified absence from the Company; (D) conviction of a felony or a crime involving moral turpitude causing material harm to the standing and reputation of the Company; or (E) unauthorized use or disclosure of any proprietary information or trade secrets of the Company or any other party to whom Executive owes an obligation of non-disclosure as a result of Executive's relationship with the Company, which use or disclosure causes or is likely to cause material harm to the Company.

(b) Good Reason. For purposes of this Agreement, "**Good Reason**" for Executive's resignation of his employment will exist following the occurrence of any of the following without Executive's written consent: (A) a material reduction or change in job duties, responsibilities or authority inconsistent with Executive's position with the Company and Executive's prior duties, responsibilities or authority, provided, however, that any change in Executive's position after a Change in Control shall not constitute grounds for a termination for Good Reason so long as Executive remains a member of the Company's senior management (or

becomes a member of the senior management of the surviving or acquiring entity) at the same or higher base salary as immediately prior to the Change in Control with equivalent authority and responsibility; (B) a material reduction of Executive's then current base salary, representing a reduction of more than 10 percent (10%), provided that an across-the-board reduction in the salary level of other executives of the Company by the same percentage amount as part of a general salary level reduction shall not constitute such a material salary reduction; (C) a relocation of the principal place for performance of Executive's duties to the Company to a location more than forty (40) miles from the Company's then current location; or (D) any material breach by the Company of this Agreement or Executive's Offer Letter (as defined below); provided that Executive gives written notice to the Company of the event forming the basis of the Good Reason resignation within sixty (60) days of the date the Company gives written notice to Executive of its affirmative decision to take an action set forth in (A), (B), (C) or (D) above, the Company fails to cure such basis for the Good Reason resignation within thirty (30) days after receipt of Executive's written notice and Executive terminates his employment within thirty (30) days following the expiration of the cure period.

(c) Change in Control. For purposes of this Agreement, "**Change in Control**" means the occurrence of any of the following events: (i) any sale or exchange of the capital stock by the shareholders of the Company in one transaction or series of related transactions where more than 50% of the outstanding voting power of the Company is acquired by a person or entity or group of related persons or entities; or (ii) any reorganization, consolidation or merger of the Company where the outstanding voting securities of the Company immediately before the transaction represent or are converted into less than fifty percent 50% of the outstanding voting power of the surviving entity (or its parent corporation) immediately after the transaction; or (iii) the consummation of any transaction or series of related transactions that results in the sale of all or substantially all of the assets of the Company; or (iv) any "person" or "group" (as defined in the Securities Exchange Act of 1934, as amended (the "*Exchange Act*")) becoming the "beneficial owner" (as defined in Rule 13d-3 under the Exchange Act) directly or indirectly of securities representing more than fifty percent (50%) of the voting power of the Company then outstanding.

5. Parachute Payments.

(a) If any payment or benefit (including payments and benefits pursuant to this Agreement) that Executive would receive in connection with a Change in Control from the Company or otherwise ("**Transaction Payment**") would (i) constitute a "parachute payment" within the meaning of Section 280G of the Code, and (ii) but for this sentence, be subject to the excise tax imposed by Section 4999 of the Code (the "**Excise Tax**"), then the Company shall cause to be determined, before any amounts of the Transaction Payment are paid to Executive, which of the following two alternative forms of payment would result in Executive's receipt, on an after-tax basis, of the greater amount of the Transaction Payment notwithstanding that all or some portion of the Transaction Payment may be subject to the Excise Tax: (1) payment in full of the entire amount of the Transaction Payment (a "**Full Payment**"), or (2) payment of only a part of the Transaction Payment so that Executive receives the largest payment possible without the imposition of the Excise Tax (a "**Reduced Payment**"). For purposes of determining whether to make a Full Payment or a Reduced Payment, the Company shall cause to be taken into account all applicable federal, state and local income and employment taxes and the Excise Tax

(all computed at the highest applicable marginal rate, net of the maximum reduction in federal income taxes which could be obtained from a deduction of such state and local taxes). If a Reduced Payment is made, (x) Executive shall have no rights to any additional payments and/or benefits constituting the Transaction Payment, and (y) reduction in payments and/or benefits shall occur in the manner that results in the greatest economic benefit to Executive as determined in this paragraph. If more than one method of reduction will result in the same economic benefit, the portions of the Transaction Payment shall be reduced pro rata.

(b) The professional firm engaged by the Company for general tax purposes as of the day prior to the effective date of the Change in Control shall make all determinations required to be made under this Section 5. If the professional firm so engaged by the Company is serving as accountant or auditor for the individual, entity or group effecting the Change in Control, the Company shall appoint a nationally recognized independent registered public accounting firm to make the determinations required hereunder. The Company shall bear all expenses with respect to the determinations by such professional firm required to be made hereunder.

(c) The professional firm engaged to make the determinations hereunder shall provide its calculations, together with detailed supporting documentation, to the Company and Executive within fifteen (15) calendar days after the date on which Executive's right to a Transaction Payment is triggered or such other time as reasonably requested by the Company or Executive. If the professional firm determines that no Excise Tax is payable with respect to the Transaction Payment, either before or after the application of the Reduced Amount, it shall furnish the Company and Executive with detailed supporting calculations of its determinations that no Excise Tax will be imposed with respect to such Transaction Payment. Any good faith determinations of the professional firm made hereunder shall be final, binding and conclusive upon the Company and Executive.

6. Other Employment Terms and Conditions. The employment relationship between the parties shall be governed by the general employment policies and procedures of the Company, including those relating to the protection of confidential information and assignment of inventions; provided, however, that when the terms of this Agreement differ from or are in conflict with the Company's general employment policies or procedures, this Agreement shall control.

7. Miscellaneous Provisions.

(a) No Duty to Mitigate. Executive shall not be required to mitigate the amount of any payment contemplated by this Agreement (whether by seeking new employment or in any other manner), nor shall any such payment be reduced by any earnings that Executive may receive from any other source.

(b) Waiver. No provision of this Agreement shall be modified, waived or discharged unless the modification, waiver or discharge is agreed to in writing and signed by Executive and by an authorized officer of the Company (other than Executive). No waiver by either party of any breach of, or of compliance with, any condition or provision of this

Agreement by the other party shall be considered a waiver of any other condition or provision or of the same condition or provision at another time.

(c) Whole Agreement. No agreements, representations or understandings (whether oral or written and whether express or implied) which are not expressly set forth in this Agreement have been made or entered into by either party with respect to the subject matter hereof. This Agreement supersedes any agreement (or portion thereof) concerning similar subject matter dated prior to the date of this Agreement, including but not limited to Executive's offer letter from the Company dated January 1, 2007, as amended (the "**Offer Letter**"), and by execution of this Agreement both parties agree that any such predecessor agreement (or portion thereof) shall be deemed null and void. For the avoidance of doubt, the parties agree that this Agreement does not supersede the provisions of the Offer Letter that do not address severance benefits, the provisions of any equity plan of the Company that provides for vesting acceleration benefits on the event of a Change in Control in which the successor corporation does not assume or substitute for outstanding equity awards or Executive's Employee Invention Assignment and Confidentiality Agreement with the Company.

(d) Choice of Law. The validity, interpretation, construction and performance of this Agreement shall be governed by the laws of the State of California without reference to conflict of laws provisions.

(e) Severability. If any term or provision of this Agreement or the application thereof to any circumstance shall, in any jurisdiction and to any extent, be invalid or unenforceable, such term or provision shall be ineffective as to such jurisdiction to the extent of such invalidity or unenforceability without invalidating or rendering unenforceable the remaining terms and provisions of this Agreement or the application of such terms and provisions to circumstances other than those as to which it is held invalid or unenforceable, and a suitable and equitable term or provision shall be substituted therefor to carry out, insofar as may be valid and enforceable, the intent and purpose of the invalid or unenforceable term or provision.

(f) Arbitration. Executive and the Company agree to attempt to settle any disputes arising in connection with this Agreement through good faith consultation. In the event that Executive and the Company are not able to resolve any such disputes within fifteen (15) days after notification in writing to the other, Executive and the Company agree that any dispute or claim arising out of or in connection with this Agreement will be finally settled by binding arbitration in Sonoma County, California in accordance with the rules of the American Arbitration Association by one arbitrator mutually agreed upon by the parties. The arbitrator will apply California law, without reference to rules of conflicts of law or rules of statutory arbitration, to the resolution of any dispute. Except as set forth in Subparagraph (e) above, the arbitrator shall not have authority to modify the terms of this Agreement. The Company shall pay the costs of the arbitration proceeding. Each party shall, unless otherwise determined by the arbitrator, bear its or his own attorneys' fees and expenses, provided however that if Executive prevails in an arbitration proceeding, the Company shall reimburse Executive for his reasonable attorneys' fees and costs. Judgment on the award rendered by the arbitrator may be entered in any court having jurisdiction thereof. Notwithstanding the foregoing, the Company and Executive may apply to any court of competent jurisdiction for preliminary or interim equitable

relief, or to compel arbitration in accordance with this paragraph, without breach of this arbitration provision.

(g) Legal Fees and Expenses. The parties shall each bear their own expenses, legal fees and other fees incurred in connection with the execution of this Agreement.

(h) No Assignment of Benefits. The rights of any person to payments or benefits under this Agreement shall not be made subject to option or assignment, either by voluntary or involuntary assignment or by operation of law, including (without limitation) bankruptcy, garnishment, attachment or other creditor's process, and any action in violation of this Section 7(h) shall be void.

(i) Assignment by Company. The Company may assign its rights under this Agreement to an affiliate, and an affiliate may assign its rights under this Agreement to another affiliate of the Company or to the Company. In the case of any such assignment, the term "Company" when used in a section of this Agreement shall mean the corporation that actually employs the Executive.

(j) Counterparts. This Agreement may be executed in counterparts, each of which shall be deemed an original, but all of which together will constitute one and the same instrument.

IN WITNESS WHEREOF, the parties have executed this Agreement as of the date written below.

/s/ Paul B. Nahi _____

PAUL B. NAHI

Address: _____

Date: 6/14/11 _____

ENPHASE ENERGY, INC.

/s/ Sanjeev Kumar _____

Name: Sanjeev Kumar

Title: Chief Financial Officer

Date: 6/14/11 _____

EXHIBIT A
RELEASE AGREEMENT

I understand and agree completely to the terms set forth in the Enphase Energy, Inc. Executive Severance Agreement (the "**Agreement**").

I understand that this Release, together with the Agreement, constitutes the complete, final and exclusive embodiment of the entire agreement between the Company, affiliates of the Company and me with regard to the subject matter hereof. I am not relying on any promise or representation by the Company that is not expressly stated therein. Certain capitalized terms used in this Release are defined in the Agreement.

I hereby confirm my obligations under my Employee Invention Assignment and Confidentiality Agreement with the Company.

Except as otherwise set forth in this Release, I hereby generally and completely release the Company and its current and former directors, officers, Executives, shareholders, partners, agents, attorneys, predecessors, successors, parent and subsidiary entities, insurers, affiliates, and assigns (collectively, the "**Released Parties**") from any and all claims, liabilities and obligations, both known and unknown, that arise out of or are in any way related to events, acts, conduct, or omissions occurring prior to my signing this Release (collectively, the "**Released Claims**"). The Released Claims include, but are not limited to: (1) all claims arising out of or in any way related to my employment with the Company or its affiliates, or the termination of that employment; (2) all claims related to my compensation or benefits, including salary, bonuses, commissions, vacation pay, expense reimbursements, severance pay, fringe benefits, stock, stock options, or any other ownership interests in the Company or its affiliates; (3) all claims for breach of contract, wrongful termination, and breach of the implied covenant of good faith and fair dealing; (4) all tort claims, including claims for fraud, defamation, emotional distress, and discharge in violation of public policy; and (5) all federal, state, and local statutory claims, including claims for discrimination, harassment, retaliation, attorneys' fees, or other claims arising under the federal Civil Rights Act of 1964 (as amended), the federal Americans with Disabilities Act of 1990, the federal Age Discrimination in Employment Act of 1967 (as amended) ("**ADEA**"), the federal Employee Retirement Income Security Act of 1974 (as amended), and the California Fair Employment and Housing Act (as amended). Notwithstanding the foregoing, the following are not included in the Released Claims (the "**Excluded Claims**"): (1) any rights or claims for indemnification I may have pursuant to any written indemnification agreement with the Company to which I am a party, the charter or bylaws of the Company, or under applicable law; or (2) any rights which are not waivable as a matter of law. In addition, nothing in this Release prevents me from filing, cooperating with, or participating in any proceeding before the Equal Employment Opportunity Commission, the Department of Labor, the California Department of Fair Employment and Housing, or any other local, state, or federal administrative body or government agency that is authorized to enforce or administer laws related to employment, against the Company, except that I hereby waive my right to any

monetary benefits in connection with any such claim, charge or proceeding. I hereby represent and warrant that, other than the Excluded Claims, I am not aware of any claims I have or might have against any of the Released Parties that are not included in the Released Claims.

I acknowledge that I am knowingly and voluntarily waiving and releasing any rights I may have under the ADEA. I also acknowledge that the consideration given for the Released Claims is in addition to anything of value to which I was already entitled. I further acknowledge that I have been advised by this writing, as required by the ADEA, that: (a) the Released Claims do not apply to any rights or claims that arise after the date I sign this Release; (b) I should consult with an attorney prior to signing this Release (although I may choose voluntarily not to do so); (c) I have forty-five (45) days to consider this Release (although I may choose to voluntarily sign it sooner); (d) I have seven (7) days following the date I sign this Release to revoke the Release by providing written notice to an officer of the Company; and (e) the Release will not be effective until the date upon which the revocation period has expired unexercised, which will be the eighth day after I sign this Release (“**Effective Date**”).

I have received with this Release all of the information required by the ADEA, including without limitation a detailed list of the job titles and ages of all Executives who were terminated in this group termination and the ages of all Executives of the Company in the same job classification or organizational unit who were not terminated, along with information on the eligibility factors used to select Executives for the group termination and any time limits applicable to this group termination program.

I acknowledge that I have read and understand Section 1542 of the California Civil Code which reads as follows: “**A general release does not extend to claims which the creditor does not know or suspect to exist in his or her favor at the time of executing the release, which if known by him or her must have materially affected his or her settlement with the debtor.**” I hereby expressly waive and relinquish all rights and benefits under that section and any law of any jurisdiction of similar effect with respect to my release of any claims hereunder.

I hereby represent that I have been paid all compensation owed and for all hours worked, I have received all the leave and leave benefits and protections for which I am eligible, and I have not suffered any on-the-job injury for which I have not already filed a workers’ compensation claim.

I hereby agree not to disparage the Company, or its officers, directors, Executives, shareholders or agents, in any manner likely to be harmful to its or their business, business reputation, or personal reputation; *provided, however*, that I will respond accurately and fully to any question, inquiry or request for information when required by legal process.

I acknowledge that to become effective, I must sign and return this Release to the Company so that it is received not later than forty-five (45) days following the date it is provided to me, and I must not revoke it thereafter.

PAUL B. NAHI

Name: _____

Date: _____

EXHIBIT B
RELEASE AGREEMENT

I understand and agree completely to the terms set forth in the Enphase Energy, Inc. Executive Severance Agreement (the "**Agreement**").

I understand that this Release, together with the Agreement, constitutes the complete, final and exclusive embodiment of the entire agreement between the Company, affiliates of the Company and me with regard to the subject matter hereof. I am not relying on any promise or representation by the Company that is not expressly stated therein. Certain capitalized terms used in this Release are defined in the Agreement.

I hereby confirm my obligations under my Employee Invention Assignment and Confidentiality Agreement with the Company.

Except as otherwise set forth in this Release, I hereby generally and completely release the Company and its current and former directors, officers, Executives, shareholders, partners, agents, attorneys, predecessors, successors, parent and subsidiary entities, insurers, affiliates, and assigns (collectively, the "**Released Parties**") from any and all claims, liabilities and obligations, both known and unknown, that arise out of or are in any way related to events, acts, conduct, or omissions occurring prior to my signing this Release (collectively, the "**Released Claims**"). The Released Claims include, but are not limited to: (1) all claims arising out of or in any way related to my employment with the Company or its affiliates, or the termination of that employment; (2) all claims related to my compensation or benefits, including salary, bonuses, commissions, vacation pay, expense reimbursements, severance pay, fringe benefits, stock, stock options, or any other ownership interests in the Company or its affiliates; (3) all claims for breach of contract, wrongful termination, and breach of the implied covenant of good faith and fair dealing; (4) all tort claims, including claims for fraud, defamation, emotional distress, and discharge in violation of public policy; and (5) all federal, state, and local statutory claims, including claims for discrimination, harassment, retaliation, attorneys' fees, or other claims arising under the federal Civil Rights Act of 1964 (as amended), the federal Americans with Disabilities Act of 1990, the federal Age Discrimination in Employment Act of 1967 (as amended) ("**ADEA**"), the federal Executive Retirement Income Security Act of 1974 (as amended), and the California Fair Employment and Housing Act (as amended). Notwithstanding the foregoing, the following are not included in the Released Claims (the "**Excluded Claims**"): (1) any rights or claims for indemnification I may have pursuant to any written indemnification agreement with the Company to which I am a party, the charter or bylaws of the Company, or under applicable law; or (2) any rights which are not waivable as a matter of law. In addition, nothing in this Release prevents me from filing, cooperating with, or participating in any proceeding before the Equal Employment Opportunity Commission, the Department of Labor, the California Department of Fair Employment and Housing, or any other local, state, or federal administrative body or government agency that is authorized to enforce or administer laws related to employment, against the Company, except that I hereby waive my right to any monetary benefits in connection with any such claim, charge or proceeding. I hereby represent

and warrant that, other than the Excluded Claims, I am not aware of any claims I have or might have against any of the Released Parties that are not included in the Released Claims.

I acknowledge that I am knowingly and voluntarily waiving and releasing any rights I may have under the ADEA. I also acknowledge that the consideration given for the Released Claims is in addition to anything of value to which I was already entitled. I further acknowledge that I have been advised by this writing, as required by the ADEA, that: (a) the Released Claims do not apply to any rights or claims that arise after the date I sign this Release; (b) I should consult with an attorney prior to signing this Release (although I may choose voluntarily not to do so); (c) I have twenty-one (21) days to consider this Release (although I may choose to voluntarily sign it sooner); (d) I have seven (7) days following the date I sign this Release to revoke the Release by providing written notice to an officer of the Company; and (e) the Release will not be effective until the date upon which the revocation period has expired unexercised, which will be the eighth day after I sign this Release ("**Effective Date**").

I acknowledge that I have read and understand Section 1542 of the California Civil Code which reads as follows: "**A general release does not extend to claims which the creditor does not know or suspect to exist in his or her favor at the time of executing the release, which if known by him or her must have materially affected his or her settlement with the debtor.**" I hereby expressly waive and relinquish all rights and benefits under that section and any law of any jurisdiction of similar effect with respect to my release of any claims hereunder.

I hereby represent that I have been paid all compensation owed and for all hours worked, I have received all the leave and leave benefits and protections for which I am eligible, and I have not suffered any on-the-job injury for which I have not already filed a workers' compensation claim.

I hereby agree not to disparage the Company, or its officers, directors, Executives, shareholders or agents, in any manner likely to be harmful to its or their business, business reputation, or personal reputation; *provided, however*, that I will respond accurately and fully to any question, inquiry or request for information when required by legal process.

I acknowledge that to become effective, I must sign and return this Release to the Company so that it is received not later than twenty-one (21) days following the date it is provided to me, and I must not revoke it thereafter.

PAUL B. NAHI

Name: _____

Date: _____

ENPHASE ENERGY, INC.

CHANGE IN CONTROL AND SEVERANCE AGREEMENT

This Change in Control and Severance Agreement (the “**Agreement**”) is dated as of June 14, 2011, by and between Sanjeev Kumar (“**Executive**”) and Enphase Energy, Inc., a Delaware corporation (the “**Company**”). This Agreement is intended to provide Executive with certain benefits described herein upon the occurrence of specific events.

RECITALS

A. It is expected that another company may from time to time consider the possibility of acquiring the Company or that a Change in Control may otherwise occur, with or without the approval of the Company’s Board of Directors (the “**Board**”). The Board recognizes that such consideration can be a distraction to Executive and can cause Executive to consider alternative employment opportunities. The Board has determined that it is in the best interests of the Company and its stockholders to assure that the Company will have the continued dedication and objectivity of the Executive, notwithstanding the possibility, threat or occurrence of a Change in Control (as defined below) of the Company.

B. The Company’s Board believes it is in the best interests of the Company and its shareholders to retain Executive and provide incentives to Executive to continue in the service of the Company.

C. The Board further believes that it is imperative to provide Executive with certain benefits upon termination of Executive’s employment in connection with a Change in Control, which benefits are intended to provide Executive with financial security and provide sufficient income and encouragement to Executive to remain with the Company, notwithstanding the possibility of a Change in Control.

D. To accomplish the foregoing objectives, the Board has directed the Company, upon execution of this Agreement by Executive, to agree to the terms provided in this Agreement.

Now therefore, in consideration of the mutual promises, covenants and agreements contained herein, and in consideration of the continuing employment of Executive by the Company, the parties hereto agree as follows:

1. At-Will Employment. Executive’s employment is at-will, which means that the Company may terminate Executive’s employment at any time, with or without advance notice, and with or without Cause. Similarly, Executive may resign Executive’s employment at any time, with or without advance notice or Good Reason. Executive shall not receive any compensation of any kind, including, without limitation, equity award vesting acceleration and severance benefits, following Executive’s last day of employment with the Company, except as expressly provided herein. Executive shall devote all reasonable efforts to the performance of Executive’s duties, and shall perform such duties in good faith.

2. Benefits Upon Termination of Employment.

(a) **Termination in connection with or following a Change in Control.** If Executive's employment is terminated without Cause (and other than as a result of Executive's death or disability) or Executive resigns for Good Reason, in either case in connection with or within twenty four (24) months after a Change in Control, and provided such termination constitutes a "separation from service" (within the meaning of Treasury Regulation Section 1.409A-1(h), a "**Separation from Service**"), and provided Executive signs and allows to become effective a release substantially in the form attached hereto as **EXHIBIT A** or **EXHIBIT B**, as applicable (the "**Release**") within the time period provided therein, then the Company shall provide Executive with the following severance benefits (the "**Separation Benefits**"):

(i) The Company shall pay Executive an amount equal to six (6) months of Executive's then current base salary, ignoring any decrease in base salary that forms the basis for Good Reason, less all applicable withholdings and deductions, paid over such 6-month period (the "**Salary Continuation**"). The Salary Continuation will be paid in equal installments on the Company's regular payroll schedule and will be subject to applicable tax withholdings over the period outlined above following the date of Executive's Separation from Service as set forth in Section 3 below.

(ii) Should Executive elect to continue his health insurance benefits pursuant to the Consolidated Omnibus Budget Reconciliation Act of 1985 ("**COBRA**") and any analogous provisions of applicable state law, the Company shall pay Executive's COBRA group health insurance premiums for Executive and his eligible dependents for a period of six (6) months following the effective date of such termination of employment described in Section 2(a) (the "**COBRA Payment Period**"). References to COBRA premiums shall not include any amounts payable by Executive under an Internal Revenue Code Section 125 health care reimbursement plan. Notwithstanding the foregoing, if the Company determines, in its sole discretion, that the Company cannot provide the COBRA premium benefits without potentially incurring financial costs or penalties under applicable law (including, without limitation, Section 2716 of the Public Health Service Act), the Company shall in lieu thereof pay Executive a taxable cash amount, which payment shall be made regardless of whether Executive or Executive's eligible family members elect health care continuation coverage (the "**Health Care Benefit Payment**"). The Health Care Benefit Payment shall be paid in monthly installments on the same schedule that the COBRA Premiums would otherwise have been paid to the insurer. The Health Care Benefit Payment shall be equal to the amount that the Company would have otherwise paid for COBRA insurance premiums (which amount shall be calculated based on the premium for the first month of coverage), and shall be paid until the expiration of the COBRA Payment Period.

(iii) The vesting and/or exercisability of any outstanding equity awards held by Executive at the time of Executive's Separation from Service shall be accelerated as to 100% of the then unvested portions of such outstanding equity awards as of the date of Executive's Separation from Service.

3. Limitations And Conditions On Separation Benefits

(a) Release Prior to Payment of Benefits. Prior to the payment of any of the Separation Benefits, Executive shall execute, and allow to become effective, the Release within the time frame set forth therein, but not later than sixty (60) days following Executive's Separation from Service (the "**Release Effective Date**"). Such Release shall specifically relate to all of Executive's rights and claims in existence at the time of such execution and shall confirm Executive's continuing obligations to the Company (including but not limited to obligations under any confidentiality and/or non-solicitation agreement with the Company). No Separation Benefits will be paid prior to the Release Effective Date. Within five (5) days following the Release Effective Date, the Company will pay Executive the Separation Benefits Executive would otherwise have received on or prior to such date but for the delay in payment related to the effectiveness of the Release, with the balance of the benefits being paid as originally scheduled. Unless a Change in Control has occurred, the Board, in its sole discretion, may modify the form of the required Release to comply with applicable law and shall determine the form of the required Release, which may be incorporated into a termination agreement or other agreement with Executive. Notwithstanding the foregoing, if the Company (or, if applicable, the successor entity thereto) determines that any of the Separation Benefits constitute "deferred compensation" under Section 409A (defined below), then, solely to the extent necessary to avoid the incurrence of the adverse personal tax consequences under Section 409A, no Separation Benefits will be paid prior to the sixtieth (60th) day following Executive's Separation from Service. On the sixtieth (60th) day following the date of Separation from Service, the Company will pay to Executive in a lump sum the applicable Separation Benefits that Employee would otherwise have received on or prior to such date, with the balance of the Separation Benefits being paid as originally scheduled.

(b) Income and Employment Taxes. Executives agrees that Executive shall be responsible for any applicable taxes of any nature (including any penalties or interest that may apply to such taxes) that the Company reasonably determines apply to any payment made hereunder, that Executive's receipt of any benefit hereunder is conditioned on Executive's satisfaction of any applicable withholding or similar obligations that apply to such benefit, and that any cash payment owed hereunder will be reduced to satisfy any such withholding or similar obligations that may apply.

(c) Compliance with Section 409A. It is intended that each installment of the payments and benefits provided for in this Agreement is a separate "payment" for purposes of Treasury Regulation Section 1.409A-2(b)(2)(i). For the avoidance of doubt, it is intended that payments of the amounts set forth in this Agreement satisfy, to the greatest extent possible, the exemptions from the application of Section 409A of the Internal Revenue Code of 1986, as amended (the "**Code**") (Section 409A of the Code, together, with any state law of similar effect, "**Section 409A**") provided under Treasury Regulations 1.409A-1(b)(4), 1.409A-1(b)(5) and 1.409A-1(b)(9). However, if the Company (or, if applicable, the successor entity thereto) determines that the severance payments and benefits provided under this Agreement (the "**Agreement Payments**") constitute "deferred compensation" under Section 409A and Executive is, on the date of his Separation from Service, a "specified Executive" of the Company or any successor entity thereto, as such term is defined in Section 409A(a)(2)(B)(i) of the Code (a "**Specified Executive**"), then, solely to the extent necessary to avoid the incurrence of the

adverse personal tax consequences under Section 409A, the timing of the Separation Benefit described in Section 2(a)(i) shall be delayed as follows: on the earlier to occur of (i) the date that is six months and one day after Executive's Separation from Service or (ii) the date of Executive's death (such earlier date, the "**Delayed Initial Payment Date**"), the Company (or the successor entity thereto, as applicable) shall pay to Executive a lump sum amount equal to the applicable benefit that Executive would otherwise have received through the Delayed Initial Payment Date if the commencement of the payment of the benefit had not been so delayed pursuant to this Section 3(c).

(d) Conflicts. Executive represents that his performance of all the terms of this Agreement will not breach any other agreement to which Executive is a party. Executive has not, and will not during the term of this Agreement, enter into any oral or written agreement in conflict with any of the provisions of this Agreement. Executive further represents that Executive is entering into or has entered into an employment relationship with the Company of his own free will and that Executive has not been solicited as an employee in any way by the Company.

(e) Successors. Any successor to the Company (whether direct or indirect and whether by purchase, lease, merger, consolidation, liquidation or otherwise) to all or substantially all of the Company's business and/or assets shall assume the obligations under this Agreement and agree expressly to perform the obligations under this Agreement in the same manner and to the same extent as the Company would be required to perform such obligations in the absence of a succession. The terms of this Agreement and all of Executive's rights hereunder and thereunder shall inure to the benefit of, and be enforceable by, Executive's personal or legal representatives, executors, administrators, successors, heirs, distributees, devisees and legatees.

(f) Notice. Notices and all other communications contemplated by this Agreement shall be in writing and shall be deemed to have been duly given when personally delivered or when mailed by U.S. registered or certified mail, return receipt requested and postage prepaid. Mailed notices to Executive shall be addressed to Executive at the home address which Executive most recently communicated to the Company in writing. In the case of the Company, mailed notices shall be addressed to its corporate headquarters, and all notices shall be directed to the attention of its Chief Financial Officer.

4. Definitions.

(a) Cause. For purposes of this Agreement, "**Cause**", as determined by the Board acting in good faith and based on information then known to it, means: (A) gross negligence or willful misconduct in the performance of duties to the Company where such gross negligence or willful misconduct has resulted or is likely to result in substantial and material damage to the Company or its subsidiaries; (B) a material failure to comply with the Company's written policies after having received from the Company notice of, and a reasonable time to cure, such failure; (C) repeated unexplained or unjustified absence from the Company; (D) conviction of a felony or a crime involving moral turpitude causing material harm to the standing and reputation of the Company; or (E) unauthorized use or disclosure of any proprietary information or trade secrets of the Company or any other party to whom Executive owes an obligation of non-disclosure as a result of Executive's relationship with the Company, which use or disclosure causes or is likely to cause material harm to the Company.

(b) Good Reason. For purposes of this Agreement, “Good Reason” for Executive’s resignation of his employment will exist following the occurrence of any of the following without Executive’s written consent: (A) a material reduction or change in job duties, responsibilities or authority inconsistent with Executive’s position with the Company and Executive’s prior duties, responsibilities or authority, provided, however, that any change in Executive’s position after a Change in Control shall not constitute grounds for a termination for Good Reason so long as Executive remains a member of the Company’s senior management (or becomes a member of the senior management of the surviving or acquiring entity) at the same or higher base salary as immediately prior to the Change in Control with equivalent authority and responsibility; (B) a material reduction of Executive’s then current base salary, representing a reduction of more than 10 percent (10%), provided that an across-the-board reduction in the salary level of other executives of the Company by the same percentage amount as part of a general salary level reduction shall not constitute such a material salary reduction; (C) a relocation of the principal place for performance of Executive’s duties to the Company to a location more than forty (40) miles from the Company’s then current location; or (D) any material breach by the Company of this Agreement or Executive’s Employment Agreement (as defined below); provided that Executive gives written notice to the Company of the event forming the basis of the Good Reason resignation within sixty (60) days of the date the Company gives written notice to Executive of its affirmative decision to take an action set forth in (A), (B), (C) or (D) above, the Company fails to cure such basis for the Good Reason resignation within thirty (30) days after receipt of Executive’s written notice and Executive terminates his employment within thirty (30) days following the expiration of the cure period.

(c) Change in Control. For purposes of this Agreement, “*Change in Control*” means the occurrence of any of the following events: (i) any sale or exchange of the capital stock by the shareholders of the Company in one transaction or series of related transactions where more than 50% of the outstanding voting power of the Company is acquired by a person or entity or group of related persons or entities; or (ii) any reorganization, consolidation or merger of the Company where the outstanding voting securities of the Company immediately before the transaction represent or are converted into less than fifty percent 50% of the outstanding voting power of the surviving entity (or its parent corporation) immediately after the transaction; or (iii) the consummation of any transaction or series of related transactions that results in the sale of all or substantially all of the assets of the Company; or (iv) any “person” or “group” (as defined in the Securities Exchange Act of 1934, as amended (the “*Exchange Act*”)) becoming the “beneficial owner” (as defined in Rule 13d-3 under the Exchange Act) directly or indirectly of securities representing more than fifty percent (50%) of the voting power of the Company then outstanding.

5. Parachute Payments.

(a) If any payment or benefit (including payments and benefits pursuant to this Agreement) that Executive would receive in connection with a Change in Control from the Company or otherwise (“*Transaction Payment*”) would (i) constitute a “parachute payment” within the meaning of Section 280G of the Code, and (ii) but for this sentence, be subject to the excise tax imposed by Section 4999 of the Code (the “*Excise Tax*”), then the Company shall cause to be determined, before any amounts of the Transaction Payment are paid to Executive, which of the following two alternative forms of payment would result in Executive’s receipt, on

an after-tax basis, of the greater amount of the Transaction Payment notwithstanding that all or some portion of the Transaction Payment may be subject to the Excise Tax: (1) payment in full of the entire amount of the Transaction Payment (a "**Full Payment**"), or (2) payment of only a part of the Transaction Payment so that Executive receives the largest payment possible without the imposition of the Excise Tax (a "**Reduced Payment**"). For purposes of determining whether to make a Full Payment or a Reduced Payment, the Company shall cause to be taken into account all applicable federal, state and local income and employment taxes and the Excise Tax (all computed at the highest applicable marginal rate, net of the maximum reduction in federal income taxes which could be obtained from a deduction of such state and local taxes). If a Reduced Payment is made, (x) Executive shall have no rights to any additional payments and/or benefits constituting the Transaction Payment, and (y) reduction in payments and/or benefits shall occur in the manner that results in the greatest economic benefit to Executive as determined in this paragraph. If more than one method of reduction will result in the same economic benefit, the portions of the Transaction Payment shall be reduced pro rata.

(b) The professional firm engaged by the Company for general tax purposes as of the day prior to the effective date of the Change in Control shall make all determinations required to be made under this Section 5. If the professional firm so engaged by the Company is serving as accountant or auditor for the individual, entity or group effecting the Change in Control, the Company shall appoint a nationally recognized independent registered public accounting firm to make the determinations required hereunder. The Company shall bear all expenses with respect to the determinations by such professional firm required to be made hereunder.

(c) The professional firm engaged to make the determinations hereunder shall provide its calculations, together with detailed supporting documentation, to the Company and Executive within fifteen (15) calendar days after the date on which Executive's right to a Transaction Payment is triggered or such other time as reasonably requested by the Company or Executive. If the professional firm determines that no Excise Tax is payable with respect to the Transaction Payment, either before or after the application of the Reduced Amount, it shall furnish the Company and Executive with detailed supporting calculations of its determinations that no Excise Tax will be imposed with respect to such Transaction Payment. Any good faith determinations of the professional firm made hereunder shall be final, binding and conclusive upon the Company and Executive.

6. Other Employment Terms and Conditions. The employment relationship between the parties shall be governed by the general employment policies and procedures of the Company, including those relating to the protection of confidential information and assignment of inventions; provided, however, that when the terms of this Agreement differ from or are in conflict with the Company's general employment policies or procedures, this Agreement shall control.

7. Miscellaneous Provisions.

(a) **No Duty to Mitigate.** Executive shall not be required to mitigate the amount of any payment contemplated by this Agreement (whether by seeking new employment or in any other manner), nor shall any such payment be reduced by any earnings that Executive may receive from any other source.

(b) Waiver. No provision of this Agreement shall be modified, waived or discharged unless the modification, waiver or discharge is agreed to in writing and signed by Executive and by an authorized officer of the Company (other than Executive). No waiver by either party of any breach of, or of compliance with, any condition or provision of this Agreement by the other party shall be considered a waiver of any other condition or provision or of the same condition or provision at another time.

(c) Whole Agreement. No agreements, representations or understandings (whether oral or written and whether express or implied) which are not expressly set forth in this Agreement have been made or entered into by either party with respect to the subject matter hereof. This Agreement supersedes any agreement (or portion thereof) concerning similar subject matter dated prior to the date of this Agreement, including but not limited to Executive's offer letter with the Company dated November 12, 2009 (the "**Employment Agreement**"), and by execution of this Agreement both parties agree that any such predecessor agreement (or portion thereof) shall be deemed null and void. For the avoidance of doubt, the parties agree that this Agreement does not supersede the provisions of the Employee Agreement that do not address termination or severance benefits, the provisions of any equity plan of the Company that provides for vesting acceleration benefits on the event of a Change in Control in which the successor corporation does not assume or substitute for outstanding equity awards or Executive's Employee Invention Assignment and Confidentiality Agreement with the Company.

(d) Choice of Law. The validity, interpretation, construction and performance of this Agreement shall be governed by the laws of the State of California without reference to conflict of laws provisions.

(e) Severability. If any term or provision of this Agreement or the application thereof to any circumstance shall, in any jurisdiction and to any extent, be invalid or unenforceable, such term or provision shall be ineffective as to such jurisdiction to the extent of such invalidity or unenforceability without invalidating or rendering unenforceable the remaining terms and provisions of this Agreement or the application of such terms and provisions to circumstances other than those as to which it is held invalid or unenforceable, and a suitable and equitable term or provision shall be substituted therefor to carry out, insofar as may be valid and enforceable, the intent and purpose of the invalid or unenforceable term or provision.

(f) Arbitration. Executive and the Company agree to attempt to settle any disputes arising in connection with this Agreement through good faith consultation. In the event that Executive and the Company are not able to resolve any such disputes within fifteen (15) days after notification in writing to the other, Executive and the Company agree that any dispute or claim arising out of or in connection with this Agreement will be finally settled by binding arbitration in Sonoma County, California in accordance with the rules of the American Arbitration Association by one arbitrator mutually agreed upon by the parties. The arbitrator will apply California law, without reference to rules of conflicts of law or rules of statutory arbitration, to the resolution of any dispute. Except as set forth in Subparagraph (e) above, the arbitrator shall not have authority to modify the terms of this Agreement. The Company shall pay the costs of the arbitration proceeding. Each party shall, unless otherwise determined by the arbitrator, bear its or his own attorneys' fees and expenses, provided however that if Executive prevails in an arbitration proceeding, the Company shall reimburse Executive for his reasonable attorneys' fees and costs. Judgment on the award rendered by the arbitrator may be entered in

any court having jurisdiction thereof. Notwithstanding the foregoing, the Company and Executive may apply to any court of competent jurisdiction for preliminary or interim equitable relief, or to compel arbitration in accordance with this paragraph, without breach of this arbitration provision.

(g) Legal Fees and Expenses. The parties shall each bear their own expenses, legal fees and other fees incurred in connection with the execution of this Agreement.

(h) No Assignment of Benefits. The rights of any person to payments or benefits under this Agreement shall not be made subject to option or assignment, either by voluntary or involuntary assignment or by operation of law, including (without limitation) bankruptcy, garnishment, attachment or other creditor's process, and any action in violation of this Section 7(h) shall be void.

(i) Assignment by Company. The Company may assign its rights under this Agreement to an affiliate, and an affiliate may assign its rights under this Agreement to another affiliate of the Company or to the Company. In the case of any such assignment, the term "Company" when used in a section of this Agreement shall mean the corporation that actually employs the Executive.

(j) Counterparts. This Agreement may be executed in counterparts, each of which shall be deemed an original, but all of which together will constitute one and the same instrument.

IN WITNESS WHEREOF, the parties have executed this Agreement as of the date written below.

/s/ Sanjeev Kumar

SANJEEV KUMAR

Address: _____

Date: 6/14/11

ENPHASE ENERGY, INC.

/s/ Paul B. Nahi

Name: Paul Nahi

Title: Chief Executive Officer

Date: 6/14/11

EXHIBIT A
RELEASE AGREEMENT

I understand and agree completely to the terms set forth in the Enphase Energy, Inc. Change in Control and Severance Agreement (the "**Agreement**").

I understand that this Release, together with the Agreement, constitutes the complete, final and exclusive embodiment of the entire agreement between the Company, affiliates of the Company and me with regard to the subject matter hereof. I am not relying on any promise or representation by the Company that is not expressly stated therein. Certain capitalized terms used in this Release are defined in the Agreement.

I hereby confirm my obligations under my Employee Invention Assignment and Confidentiality Agreement with the Company.

Except as otherwise set forth in this Release, I hereby generally and completely release the Company and its current and former directors, officers, Executives, shareholders, partners, agents, attorneys, predecessors, successors, parent and subsidiary entities, insurers, affiliates, and assigns (collectively, the "**Released Parties**") from any and all claims, liabilities and obligations, both known and unknown, that arise out of or are in any way related to events, acts, conduct, or omissions occurring prior to my signing this Release (collectively, the "**Released Claims**"). The Released Claims include, but are not limited to: (1) all claims arising out of or in any way related to my employment with the Company or its affiliates, or the termination of that employment; (2) all claims related to my compensation or benefits, including salary, bonuses, commissions, vacation pay, expense reimbursements, severance pay, fringe benefits, stock, stock options, or any other ownership interests in the Company or its affiliates; (3) all claims for breach of contract, wrongful termination, and breach of the implied covenant of good faith and fair dealing; (4) all tort claims, including claims for fraud, defamation, emotional distress, and discharge in violation of public policy; and (5) all federal, state, and local statutory claims, including claims for discrimination, harassment, retaliation, attorneys' fees, or other claims arising under the federal Civil Rights Act of 1964 (as amended), the federal Americans with Disabilities Act of 1990, the federal Age Discrimination in Employment Act of 1967 (as amended) ("**ADEA**"), the federal Employee Retirement Income Security Act of 1974 (as amended), and the California Fair Employment and Housing Act (as amended). Notwithstanding the foregoing, the following are not included in the Released Claims (the "**Excluded Claims**"): (1) any rights or claims for indemnification I may have pursuant to any written indemnification agreement with the Company to which I am a party, the charter or bylaws of the Company, or under applicable law; or (2) any rights which are not waivable as a matter of law. In addition, nothing in this Release prevents me from filing, cooperating with, or participating in any proceeding before the Equal Employment Opportunity Commission, the Department of Labor, the California Department of Fair Employment and Housing, or any other local, state, or federal administrative body or government agency that is authorized to enforce or administer laws related to employment, against the Company, except that I hereby waive my right to any monetary benefits in connection with any such claim, charge or proceeding. I hereby represent

and warrant that, other than the Excluded Claims, I am not aware of any claims I have or might have against any of the Released Parties that are not included in the Released Claims.

I acknowledge that I am knowingly and voluntarily waiving and releasing any rights I may have under the ADEA. I also acknowledge that the consideration given for the Released Claims is in addition to anything of value to which I was already entitled. I further acknowledge that I have been advised by this writing, as required by the ADEA, that: (a) the Released Claims do not apply to any rights or claims that arise after the date I sign this Release; (b) I should consult with an attorney prior to signing this Release (although I may choose voluntarily not to do so); (c) I have forty-five (45) days to consider this Release (although I may choose to voluntarily sign it sooner); (d) I have seven (7) days following the date I sign this Release to revoke the Release by providing written notice to an officer of the Company; and (e) the Release will not be effective until the date upon which the revocation period has expired unexercised, which will be the eighth day after I sign this Release (“**Effective Date**”).

I have received with this Release all of the information required by the ADEA, including without limitation a detailed list of the job titles and ages of all Executives who were terminated in this group termination and the ages of all Executives of the Company in the same job classification or organizational unit who were not terminated, along with information on the eligibility factors used to select Executives for the group termination and any time limits applicable to this group termination program.

I acknowledge that I have read and understand Section 1542 of the California Civil Code which reads as follows: “**A general release does not extend to claims which the creditor does not know or suspect to exist in his or her favor at the time of executing the release, which if known by him or her must have materially affected his or her settlement with the debtor.**” I hereby expressly waive and relinquish all rights and benefits under that section and any law of any jurisdiction of similar effect with respect to my release of any claims hereunder.

I hereby represent that I have been paid all compensation owed and for all hours worked, I have received all the leave and leave benefits and protections for which I am eligible, and I have not suffered any on-the-job injury for which I have not already filed a workers’ compensation claim.

I hereby agree not to disparage the Company, or its officers, directors, Executives, shareholders or agents, in any manner likely to be harmful to its or their business, business reputation, or personal reputation; *provided, however*, that I will respond accurately and fully to any question, inquiry or request for information when required by legal process.

I acknowledge that to become effective, I must sign and return this Release to the Company so that it is received not later than forty-five (45) days following the date it is provided to me, and I must not revoke it thereafter.

SANJEEV KUMAR

Name: _____

Date: _____

3.

EXHIBIT B
RELEASE AGREEMENT

I understand and agree completely to the terms set forth in the Enphase Energy, Inc. Change in Control and Severance Agreement (the "**Agreement**").

I understand that this Release, together with the Agreement, constitutes the complete, final and exclusive embodiment of the entire agreement between the Company, affiliates of the Company and me with regard to the subject matter hereof. I am not relying on any promise or representation by the Company that is not expressly stated therein. Certain capitalized terms used in this Release are defined in the Agreement.

I hereby confirm my obligations under my Employee Invention Assignment and Confidentiality Agreement with the Company.

Except as otherwise set forth in this Release, I hereby generally and completely release the Company and its current and former directors, officers, Executives, shareholders, partners, agents, attorneys, predecessors, successors, parent and subsidiary entities, insurers, affiliates, and assigns (collectively, the "**Released Parties**") from any and all claims, liabilities and obligations, both known and unknown, that arise out of or are in any way related to events, acts, conduct, or omissions occurring prior to my signing this Release (collectively, the "**Released Claims**"). The Released Claims include, but are not limited to: (1) all claims arising out of or in any way related to my employment with the Company or its affiliates, or the termination of that employment; (2) all claims related to my compensation or benefits, including salary, bonuses, commissions, vacation pay, expense reimbursements, severance pay, fringe benefits, stock, stock options, or any other ownership interests in the Company or its affiliates; (3) all claims for breach of contract, wrongful termination, and breach of the implied covenant of good faith and fair dealing; (4) all tort claims, including claims for fraud, defamation, emotional distress, and discharge in violation of public policy; and (5) all federal, state, and local statutory claims, including claims for discrimination, harassment, retaliation, attorneys' fees, or other claims arising under the federal Civil Rights Act of 1964 (as amended), the federal Americans with Disabilities Act of 1990, the federal Age Discrimination in Employment Act of 1967 (as amended) ("**ADEA**"), the federal Executive Retirement Income Security Act of 1974 (as amended), and the California Fair Employment and Housing Act (as amended). Notwithstanding the foregoing, the following are not included in the Released Claims (the "**Excluded Claims**"): (1) any rights or claims for indemnification I may have pursuant to any written indemnification agreement with the Company to which I am a party, the charter or bylaws of the Company, or under applicable law; or (2) any rights which are not waivable as a matter of law. In addition, nothing in this Release prevents me from filing, cooperating with, or participating in any proceeding before the Equal Employment Opportunity Commission, the Department of Labor, the California Department of Fair Employment and Housing, or any other local, state, or federal administrative body or government agency that is authorized to enforce or administer laws related to employment, against the Company, except that I hereby waive my right to any monetary benefits in connection with any such claim, charge or proceeding. I hereby represent

and warrant that, other than the Excluded Claims, I am not aware of any claims I have or might have against any of the Released Parties that are not included in the Released Claims.

I acknowledge that I am knowingly and voluntarily waiving and releasing any rights I may have under the ADEA. I also acknowledge that the consideration given for the Released Claims is in addition to anything of value to which I was already entitled. I further acknowledge that I have been advised by this writing, as required by the ADEA, that: (a) the Released Claims do not apply to any rights or claims that arise after the date I sign this Release; (b) I should consult with an attorney prior to signing this Release (although I may choose voluntarily not to do so); (c) I have twenty-one (21) days to consider this Release (although I may choose to voluntarily sign it sooner); (d) I have seven (7) days following the date I sign this Release to revoke the Release by providing written notice to an officer of the Company; and (e) the Release will not be effective until the date upon which the revocation period has expired unexercised, which will be the eighth day after I sign this Release ("**Effective Date**").

I acknowledge that I have read and understand Section 1542 of the California Civil Code which reads as follows: "**A general release does not extend to claims which the creditor does not know or suspect to exist in his or her favor at the time of executing the release, which if known by him or her must have materially affected his or her settlement with the debtor.**" I hereby expressly waive and relinquish all rights and benefits under that section and any law of any jurisdiction of similar effect with respect to my release of any claims hereunder.

I hereby represent that I have been paid all compensation owed and for all hours worked, I have received all the leave and leave benefits and protections for which I am eligible, and I have not suffered any on-the-job injury for which I have not already filed a workers' compensation claim.

I hereby agree not to disparage the Company, or its officers, directors, Executives, shareholders or agents, in any manner likely to be harmful to its or their business, business reputation, or personal reputation; *provided, however*, that I will respond accurately and fully to any question, inquiry or request for information when required by legal process.

I acknowledge that to become effective, I must sign and return this Release to the Company so that it is received not later than twenty-one (21) days following the date it is provided to me, and I must not revoke it thereafter.

SANJEEV KUMAR

Name: _____

Date: _____

ENPHASE ENERGY, INC.

EXECUTIVE SEVERANCE AGREEMENT

This Executive Severance Agreement (the "**Agreement**") is dated as of June 14, 2011, by and between Martin Fornage ("**Executive**") and Enphase Energy, Inc., a Delaware corporation (the "**Company**"). This Agreement is intended to provide Executive with certain benefits described herein upon the occurrence of specific events.

RECITALS

A. The Company's Board of Directors (the "**Board**") believes it is in the best interests of the Company and its stockholders to retain Executive and provide incentives to Executive to continue in the service of the Company.

B. The Board further believes that it is imperative to provide Executive with certain benefits upon termination of Executive's employment, which benefits are intended to provide Executive with financial security and provide sufficient income and encouragement to Executive to remain with the Company.

C. To accomplish the foregoing objectives, the Board has directed the Company, upon execution of this Agreement by Executive, to agree to the terms provided in this Agreement.

Now therefore, in consideration of the mutual promises, covenants and agreements contained herein, and in consideration of the continuing employment of Executive by the Company, the parties hereto agree as follows:

1. At-Will Employment. Executive's employment is at-will, which means that the Company may terminate Executive's employment at any time, with or without advance notice, and with or without Cause. Similarly, Executive may resign Executive's employment at any time, with or without advance notice or Good Reason. Executive shall not receive any compensation of any kind, including, without limitation, equity award vesting acceleration and severance benefits, following Executive's last day of employment with the Company, except as expressly provided herein. Executive shall devote all reasonable efforts to the performance of Executive's duties, and shall perform such duties in good faith.

2. Benefits Upon Termination of Employment. If Executive's employment is terminated without Cause (and other than as a result of Executive's death or disability) or Executive resigns for Good Reason, and provided such termination constitutes a "separation from service" (within the meaning of Treasury Regulation Section 1.409A-1(h), a "**Separation from Service**"), and provided Executive signs and allows to become effective a release substantially in the form attached hereto as **EXHIBIT A** or **EXHIBIT B**, as applicable (the "**Release**") within the time period provided therein, then the Company shall provide Executive with the following severance benefits (the "**Separation Benefits**"):

1.

(a) The Company shall pay Executive an amount equal to six (6) months of Executive's then current base salary and annual cash bonus (if any), ignoring any decrease in base salary that forms the basis for Good Reason, less all applicable withholdings and deductions, paid over such 6-month period (the "**Salary Continuation**"). The Salary Continuation will be paid in equal installments on the Company's regular payroll schedule and will be subject to applicable tax withholdings over the period outlined above following the date of Executive's Separation from Service as set forth in Section 3 below.

(b) Should Executive elect to continue his health insurance benefits pursuant to the Consolidated Omnibus Budget Reconciliation Act of 1985 ("**COBRA**") and any analogous provisions of applicable state law, the Company shall pay Executive's COBRA group health insurance premiums for Executive and his eligible dependents for a period of six (6) months following the effective date of such termination of employment described in Section 2(a) (the "**COBRA Payment Period**"). References to COBRA premiums shall not include any amounts payable by Executive under an Internal Revenue Code Section 125 health care reimbursement plan. Notwithstanding the foregoing, if the Company determines, in its sole discretion, that the Company cannot provide the COBRA premium benefits without potentially incurring financial costs or penalties under applicable law (including, without limitation, Section 2716 of the Public Health Service Act), the Company shall in lieu thereof pay Executive a taxable cash amount, which payment shall be made regardless of whether Executive or Executive's eligible family members elect health care continuation coverage (the "**Health Care Benefit Payment**"). The Health Care Benefit Payment shall be paid in monthly installments on the same schedule that the COBRA Premiums would otherwise have been paid to the insurer. The Health Care Benefit Payment shall be equal to the amount that the Company would have otherwise paid for COBRA insurance premiums (which amount shall be calculated based on the premium for the first month of coverage), and shall be paid until the expiration of the COBRA Payment Period.

(c) The vesting and/or exercisability of any outstanding equity awards held by Executive at the time of Executive's Separation from Service shall be accelerated as to 100% of the then unvested portions of such outstanding equity awards as of the date of Executive's Separation from Service.

3. Limitations And Conditions On Separation Benefits

(a) **Release Prior to Payment of Benefits.** Prior to the payment of any of the Separation Benefits, Executive shall execute, and allow to become effective, the Release within the time frame set forth therein, but not later than sixty (60) days following Executive's Separation from Service (the "**Release Effective Date**"). Such Release shall specifically relate to all of Executive's rights and claims in existence at the time of such execution and shall confirm Executive's continuing obligations to the Company (including but not limited to obligations under any confidentiality and/or non-solicitation agreement with the Company). No Separation Benefits will be paid prior to the Release Effective Date. Within five (5) days following the Release Effective Date, the Company will pay Executive the Separation Benefits Executive would otherwise have received on or prior to such date but for the delay in payment related to the effectiveness of the Release, with the balance of the benefits being paid as originally scheduled. Unless a Separation from Service has occurred, the Board, in its sole discretion, may modify the form of the required Release to comply with applicable law and shall determine the form of the

required Release, which may be incorporated into a termination agreement or other agreement with Executive. Notwithstanding the foregoing, if the Company (or, if applicable, the successor entity thereto) determines that any of the Separation Benefits constitute “deferred compensation” under Section 409A (defined below), then, solely to the extent necessary to avoid the incurrence of the adverse personal tax consequences under Section 409A, no Separation Benefits will be paid prior to the sixtieth (60th) day following Executive’s Separation from Service. On the sixtieth (60th) day following the date of Separation from Service, the Company will pay to Executive in a lump sum the applicable Separation Benefits that Employee would otherwise have received on or prior to such date, with the balance of the Separation Benefits being paid as originally scheduled.

(b) Income and Employment Taxes. Executives agrees that Executive shall be responsible for any applicable taxes of any nature (including any penalties or interest that may apply to such taxes) that the Company reasonably determines apply to any payment made hereunder, that Executive’s receipt of any benefit hereunder is conditioned on Executive’s satisfaction of any applicable withholding or similar obligations that apply to such benefit, and that any cash payment owed hereunder will be reduced to satisfy any such withholding or similar obligations that may apply.

(c) Compliance with Section 409A. It is intended that each installment of the payments and benefits provided for in this Agreement is a separate “payment” for purposes of Treasury Regulation Section 1.409A-2(b)(2)(i). For the avoidance of doubt, it is intended that payments of the amounts set forth in this Agreement satisfy, to the greatest extent possible, the exemptions from the application of Section 409A of the Internal Revenue Code of 1986, as amended (the “Code”) (Section 409A of the Code, together, with any state law of similar effect, “Section 409A”) provided under Treasury Regulations 1.409A-1(b)(4), 1.409A-1(b)(5) and 1.409A-1(b)(9). However, if the Company (or, if applicable, the successor entity thereto) determines that the severance payments and benefits provided under this Agreement (the “Agreement Payments”) constitute “deferred compensation” under Section 409A and Executive is, on the date of his Separation from Service, a “specified Executive” of the Company or any successor entity thereto, as such term is defined in Section 409A(a)(2)(B)(i) of the Code (a “Specified Executive”), then, solely to the extent necessary to avoid the incurrence of the adverse personal tax consequences under Section 409A, the timing of the Separation Benefit described in Section 2(a) shall be delayed as follows: on the earlier to occur of (i) the date that is six months and one day after Executive’s Separation from Service or (ii) the date of Executive’s death (such earlier date, the “Delayed Initial Payment Date”), the Company (or the successor entity thereto, as applicable) shall pay to Executive a lump sum amount equal to the applicable benefit that Executive would otherwise have received through the Delayed Initial Payment Date if the commencement of the payment of the benefit had not been so delayed pursuant to this Section 3(c).

(d) Conflicts. Executive represents that his performance of all the terms of this Agreement will not breach any other agreement to which Executive is a party. Executive has not, and will not during the term of this Agreement, enter into any oral or written agreement in conflict with any of the provisions of this Agreement. Executive further represents that Executive is entering into or has entered into an employment relationship with the Company of

his own free will and that Executive has not been solicited as an employee in any way by the Company.

(e) Successors. Any successor to the Company (whether direct or indirect and whether by purchase, lease, merger, consolidation, liquidation or otherwise) to all or substantially all of the Company's business and/or assets shall assume the obligations under this Agreement and agree expressly to perform the obligations under this Agreement in the same manner and to the same extent as the Company would be required to perform such obligations in the absence of a succession. The terms of this Agreement and all of Executive's rights hereunder and thereunder shall inure to the benefit of, and be enforceable by, Executive's personal or legal representatives, executors, administrators, successors, heirs, distributees, devisees and legatees.

(f) Notice. Notices and all other communications contemplated by this Agreement shall be in writing and shall be deemed to have been duly given when personally delivered or when mailed by U.S. registered or certified mail, return receipt requested and postage prepaid. Mailed notices to Executive shall be addressed to Executive at the home address which Executive most recently communicated to the Company in writing. In the case of the Company, mailed notices shall be addressed to its corporate headquarters, and all notices shall be directed to the attention of its Chief Financial Officer.

4. Definitions.

(a) Cause. For purposes of this Agreement, "**Cause**", as determined by the Board acting in good faith and based on information then known to it, means: (A) gross negligence or willful misconduct in the performance of duties to the Company where such gross negligence or willful misconduct has resulted or is likely to result in substantial and material damage to the Company or its subsidiaries; (B) a material failure to comply with the Company's written policies after having received from the Company notice of, and a reasonable time to cure, such failure; (C) repeated unexplained or unjustified absence from the Company; (D) conviction of a felony or a crime involving moral turpitude causing material harm to the standing and reputation of the Company; or (E) unauthorized use or disclosure of any proprietary information or trade secrets of the Company or any other party to whom Executive owes an obligation of non-disclosure as a result of Executive's relationship with the Company, which use or disclosure causes or is likely to cause material harm to the Company.

(b) Good Reason. For purposes of this Agreement, "**Good Reason**" for Executive's resignation of his employment will exist following the occurrence of any of the following without Executive's written consent: (A) a material reduction or change in job duties, responsibilities or authority inconsistent with Executive's position with the Company and Executive's prior duties, responsibilities or authority, provided, however, that any change in Executive's position after a Change in Control shall not constitute grounds for a termination for Good Reason so long as Executive remains a member of the Company's senior management (or becomes a member of the senior management of the surviving or acquiring entity) at the same or higher base salary as immediately prior to the Change in Control with equivalent authority and responsibility; (B) a material reduction of Executive's then current base salary, representing a reduction of more than 10 percent (10%), provided that an across-the-board reduction in the salary level of other executives of the Company by the same percentage amount as part of a

general salary level reduction shall not constitute such a material salary reduction; (C) a relocation of the principal place for performance of Executive's duties to the Company to a location more than forty (40) miles from the Company's then current location; or (D) any material breach by the Company of this Agreement or Executive's Employment Agreement (as defined below); provided that Executive gives written notice to the Company of the event forming the basis of the Good Reason resignation within sixty (60) days of the date the Company gives written notice to Executive of its affirmative decision to take an action set forth in (A), (B), (C) or (D) above, the Company fails to cure such basis for the Good Reason resignation within thirty (30) days after receipt of Executive's written notice and Executive terminates his employment within thirty (30) days following the expiration of the cure period.

(c) Change in Control. For purposes of this Agreement, "**Change in Control**" means the occurrence of any of the following events: (i) any sale or exchange of the capital stock by the shareholders of the Company in one transaction or series of related transactions where more than 50% of the outstanding voting power of the Company is acquired by a person or entity or group of related persons or entities; or (ii) any reorganization, consolidation or merger of the Company where the outstanding voting securities of the Company immediately before the transaction represent or are converted into less than fifty percent 50% of the outstanding voting power of the surviving entity (or its parent corporation) immediately after the transaction; or (iii) the consummation of any transaction or series of related transactions that results in the sale of all or substantially all of the assets of the Company; or (iv) any "person" or "group" (as defined in the Securities Exchange Act of 1934, as amended (the "*Exchange Act*")) becoming the "beneficial owner" (as defined in Rule 13d-3 under the Exchange Act) directly or indirectly of securities representing more than fifty percent (50%) of the voting power of the Company then outstanding.

5. Parachute Payments.

(a) If any payment or benefit (including payments and benefits pursuant to this Agreement) that Executive would receive in connection with a Change in Control from the Company or otherwise ("**Transaction Payment**") would (i) constitute a "parachute payment" within the meaning of Section 280G of the Code, and (ii) but for this sentence, be subject to the excise tax imposed by Section 4999 of the Code (the "**Excise Tax**"), then the Company shall cause to be determined, before any amounts of the Transaction Payment are paid to Executive, which of the following two alternative forms of payment would result in Executive's receipt, on an after-tax basis, of the greater amount of the Transaction Payment notwithstanding that all or some portion of the Transaction Payment may be subject to the Excise Tax: (1) payment in full of the entire amount of the Transaction Payment (a "**Full Payment**"), or (2) payment of only a part of the Transaction Payment so that Executive receives the largest payment possible without the imposition of the Excise Tax (a "**Reduced Payment**"). For purposes of determining whether to make a Full Payment or a Reduced Payment, the Company shall cause to be taken into account all applicable federal, state and local income and employment taxes and the Excise Tax (all computed at the highest applicable marginal rate, net of the maximum reduction in federal income taxes which could be obtained from a deduction of such state and local taxes). If a Reduced Payment is made, (x) Executive shall have no rights to any additional payments and/or benefits constituting the Transaction Payment, and (y) reduction in payments and/or benefits shall occur in the manner that results in the greatest economic benefit to Executive as determined

in this paragraph. If more than one method of reduction will result in the same economic benefit, the portions of the Transaction Payment shall be reduced pro rata.

(b) The professional firm engaged by the Company for general tax purposes as of the day prior to the effective date of the Change in Control shall make all determinations required to be made under this Section 5. If the professional firm so engaged by the Company is serving as accountant or auditor for the individual, entity or group effecting the Change in Control, the Company shall appoint a nationally recognized independent registered public accounting firm to make the determinations required hereunder. The Company shall bear all expenses with respect to the determinations by such professional firm required to be made hereunder.

(c) The professional firm engaged to make the determinations hereunder shall provide its calculations, together with detailed supporting documentation, to the Company and Executive within fifteen (15) calendar days after the date on which Executive's right to a Transaction Payment is triggered or such other time as reasonably requested by the Company or Executive. If the professional firm determines that no Excise Tax is payable with respect to the Transaction Payment, either before or after the application of the Reduced Amount, it shall furnish the Company and Executive with detailed supporting calculations of its determinations that no Excise Tax will be imposed with respect to such Transaction Payment. Any good faith determinations of the professional firm made hereunder shall be final, binding and conclusive upon the Company and Executive.

6. Other Employment Terms and Conditions. The employment relationship between the parties shall be governed by the general employment policies and procedures of the Company, including those relating to the protection of confidential information and assignment of inventions; provided, however, that when the terms of this Agreement differ from or are in conflict with the Company's general employment policies or procedures, this Agreement shall control.

7. Miscellaneous Provisions.

(a) **No Duty to Mitigate.** Executive shall not be required to mitigate the amount of any payment contemplated by this Agreement (whether by seeking new employment or in any other manner), nor shall any such payment be reduced by any earnings that Executive may receive from any other source.

(b) **Waiver.** No provision of this Agreement shall be modified, waived or discharged unless the modification, waiver or discharge is agreed to in writing and signed by Executive and by an authorized officer of the Company (other than Executive). No waiver by either party of any breach of, or of compliance with, any condition or provision of this Agreement by the other party shall be considered a waiver of any other condition or provision or of the same condition or provision at another time.

(c) **Whole Agreement.** No agreements, representations or understandings (whether oral or written and whether express or implied) which are not expressly set forth in this Agreement have been made or entered into by either party with respect to the subject matter

hereof. This Agreement supersedes any agreement (or portion thereof) concerning similar subject matter dated prior to the date of this Agreement, including but not limited to Executive's Employment Agreement with the Company dated as of March 1, 2006, as amended (the "**Employment Agreement**"), and by execution of this Agreement both parties agree that any such predecessor agreement (or portion thereof) shall be deemed null and void. For the avoidance of doubt, the parties agree that this Agreement does not supersede the provisions of the Employment Agreement other than the sections related to "Constructive Termination" and "Termination without Cause" (as such terms are defined in the Employment Agreement), the provisions of any equity plan of the Company that provides for vesting acceleration benefits on the event of a Change in Control in which the successor corporation does not assume or substitute for outstanding equity awards or Executive's Employee Invention Assignment and Confidentiality Agreement with the Company.

(d) Choice of Law. The validity, interpretation, construction and performance of this Agreement shall be governed by the laws of the State of California without reference to conflict of laws provisions.

(e) Severability. If any term or provision of this Agreement or the application thereof to any circumstance shall, in any jurisdiction and to any extent, be invalid or unenforceable, such term or provision shall be ineffective as to such jurisdiction to the extent of such invalidity or unenforceability without invalidating or rendering unenforceable the remaining terms and provisions of this Agreement or the application of such terms and provisions to circumstances other than those as to which it is held invalid or unenforceable, and a suitable and equitable term or provision shall be substituted therefor to carry out, insofar as may be valid and enforceable, the intent and purpose of the invalid or unenforceable term or provision.

(f) Arbitration. Executive and the Company agree to attempt to settle any disputes arising in connection with this Agreement through good faith consultation. In the event that Executive and the Company are not able to resolve any such disputes within fifteen (15) days after notification in writing to the other, Executive and the Company agree that any dispute or claim arising out of or in connection with this Agreement will be finally settled by binding arbitration in Sonoma County, California in accordance with the rules of the American Arbitration Association by one arbitrator mutually agreed upon by the parties. The arbitrator will apply California law, without reference to rules of conflicts of law or rules of statutory arbitration, to the resolution of any dispute. Except as set forth in Subparagraph (e) above, the arbitrator shall not have authority to modify the terms of this Agreement. The Company shall pay the costs of the arbitration proceeding. Each party shall, unless otherwise determined by the arbitrator, bear its or his own attorneys' fees and expenses, provided however that if Executive prevails in an arbitration proceeding, the Company shall reimburse Executive for his reasonable attorneys' fees and costs. Judgment on the award rendered by the arbitrator may be entered in any court having jurisdiction thereof. Notwithstanding the foregoing, the Company and Executive may apply to any court of competent jurisdiction for preliminary or interim equitable relief, or to compel arbitration in accordance with this paragraph, without breach of this arbitration provision.

(g) Legal Fees and Expenses. The parties shall each bear their own expenses, legal fees and other fees incurred in connection with the execution of this Agreement.

(h) No Assignment of Benefits. The rights of any person to payments or benefits under this Agreement shall not be made subject to option or assignment, either by voluntary or involuntary assignment or by operation of law, including (without limitation) bankruptcy, garnishment, attachment or other creditor's process, and any action in violation of this Section 7(h) shall be void.

(i) Assignment by Company. The Company may assign its rights under this Agreement to an affiliate, and an affiliate may assign its rights under this Agreement to another affiliate of the Company or to the Company. In the case of any such assignment, the term "Company" when used in a section of this Agreement shall mean the corporation that actually employs the Executive.

(j) Counterparts. This Agreement may be executed in counterparts, each of which shall be deemed an original, but all of which together will constitute one and the same instrument.

IN WITNESS WHEREOF, the parties have executed this Agreement as of the date written below.

/s/ Martin Fornage

MARTIN FORNAGE

Address: _____

Date: 6/14/11

ENPHASE ENERGY, INC.

/s/ Paul B. Nahi

Name: Paul Nahi

Title: Chief Executive Officer

Date: 6/14/11

EXHIBIT A
RELEASE AGREEMENT

I understand and agree completely to the terms set forth in the Enphase Energy, Inc. Executive Severance Agreement (the "**Agreement**").

I understand that this Release, together with the Agreement, constitutes the complete, final and exclusive embodiment of the entire agreement between the Company, affiliates of the Company and me with regard to the subject matter hereof. I am not relying on any promise or representation by the Company that is not expressly stated therein. Certain capitalized terms used in this Release are defined in the Agreement.

I hereby confirm my obligations under my Employee Invention Assignment and Confidentiality Agreement with the Company.

Except as otherwise set forth in this Release, I hereby generally and completely release the Company and its current and former directors, officers, Executives, shareholders, partners, agents, attorneys, predecessors, successors, parent and subsidiary entities, insurers, affiliates, and assigns (collectively, the "**Released Parties**") from any and all claims, liabilities and obligations, both known and unknown, that arise out of or are in any way related to events, acts, conduct, or omissions occurring prior to my signing this Release (collectively, the "**Released Claims**"). The Released Claims include, but are not limited to: (1) all claims arising out of or in any way related to my employment with the Company or its affiliates, or the termination of that employment; (2) all claims related to my compensation or benefits, including salary, bonuses, commissions, vacation pay, expense reimbursements, severance pay, fringe benefits, stock, stock options, or any other ownership interests in the Company or its affiliates; (3) all claims for breach of contract, wrongful termination, and breach of the implied covenant of good faith and fair dealing; (4) all tort claims, including claims for fraud, defamation, emotional distress, and discharge in violation of public policy; and (5) all federal, state, and local statutory claims, including claims for discrimination, harassment, retaliation, attorneys' fees, or other claims arising under the federal Civil Rights Act of 1964 (as amended), the federal Americans with Disabilities Act of 1990, the federal Age Discrimination in Employment Act of 1967 (as amended) ("**ADEA**"), the federal Employee Retirement Income Security Act of 1974 (as amended), and the California Fair Employment and Housing Act (as amended). Notwithstanding the foregoing, the following are not included in the Released Claims (the "**Excluded Claims**"): (1) any rights or claims for indemnification I may have pursuant to any written indemnification agreement with the Company to which I am a party, the charter or bylaws of the Company, or under applicable law; or (2) any rights which are not waivable as a matter of law. In addition, nothing in this Release prevents me from filing, cooperating with, or participating in any proceeding before the Equal Employment Opportunity Commission, the Department of Labor, the California Department of Fair Employment and Housing, or any other local, state, or federal administrative body or government agency that is authorized to enforce or administer laws related to employment, against the Company, except that I hereby waive my right to any monetary benefits in connection with any such claim, charge or proceeding. I hereby represent

and warrant that, other than the Excluded Claims, I am not aware of any claims I have or might have against any of the Released Parties that are not included in the Released Claims.

I acknowledge that I am knowingly and voluntarily waiving and releasing any rights I may have under the ADEA. I also acknowledge that the consideration given for the Released Claims is in addition to anything of value to which I was already entitled. I further acknowledge that I have been advised by this writing, as required by the ADEA, that: (a) the Released Claims do not apply to any rights or claims that arise after the date I sign this Release; (b) I should consult with an attorney prior to signing this Release (although I may choose voluntarily not to do so); (c) I have forty-five (45) days to consider this Release (although I may choose to voluntarily sign it sooner); (d) I have seven (7) days following the date I sign this Release to revoke the Release by providing written notice to an officer of the Company; and (e) the Release will not be effective until the date upon which the revocation period has expired unexercised, which will be the eighth day after I sign this Release ("**Effective Date**").

I have received with this Release all of the information required by the ADEA, including without limitation a detailed list of the job titles and ages of all Executives who were terminated in this group termination and the ages of all Executives of the Company in the same job classification or organizational unit who were not terminated, along with information on the eligibility factors used to select Executives for the group termination and any time limits applicable to this group termination program.

I acknowledge that I have read and understand Section 1542 of the California Civil Code which reads as follows: "**A general release does not extend to claims which the creditor does not know or suspect to exist in his or her favor at the time of executing the release, which if known by him or her must have materially affected his or her settlement with the debtor.**" I hereby expressly waive and relinquish all rights and benefits under that section and any law of any jurisdiction of similar effect with respect to my release of any claims hereunder.

I hereby represent that I have been paid all compensation owed and for all hours worked, I have received all the leave and leave benefits and protections for which I am eligible, and I have not suffered any on-the-job injury for which I have not already filed a workers' compensation claim.

I hereby agree not to disparage the Company, or its officers, directors, Executives, shareholders or agents, in any manner likely to be harmful to its or their business, business reputation, or personal reputation; *provided, however*, that I will respond accurately and fully to any question, inquiry or request for information when required by legal process.

I acknowledge that to become effective, I must sign and return this Release to the Company so that it is received not later than forty-five (45) days following the date it is provided to me, and I must not revoke it thereafter.

MARTIN FORNAGE

Name: _____

Date: _____

3.

EXHIBIT B
RELEASE AGREEMENT

I understand and agree completely to the terms set forth in the Enphase Energy, Inc. Executive Severance Agreement (the "**Agreement**").

I understand that this Release, together with the Agreement, constitutes the complete, final and exclusive embodiment of the entire agreement between the Company, affiliates of the Company and me with regard to the subject matter hereof. I am not relying on any promise or representation by the Company that is not expressly stated therein. Certain capitalized terms used in this Release are defined in the Agreement.

I hereby confirm my obligations under my Employee Invention Assignment and Confidentiality Agreement with the Company.

Except as otherwise set forth in this Release, I hereby generally and completely release the Company and its current and former directors, officers, Executives, shareholders, partners, agents, attorneys, predecessors, successors, parent and subsidiary entities, insurers, affiliates, and assigns (collectively, the "**Released Parties**") from any and all claims, liabilities and obligations, both known and unknown, that arise out of or are in any way related to events, acts, conduct, or omissions occurring prior to my signing this Release (collectively, the "**Released Claims**"). The Released Claims include, but are not limited to: (1) all claims arising out of or in any way related to my employment with the Company or its affiliates, or the termination of that employment; (2) all claims related to my compensation or benefits, including salary, bonuses, commissions, vacation pay, expense reimbursements, severance pay, fringe benefits, stock, stock options, or any other ownership interests in the Company or its affiliates; (3) all claims for breach of contract, wrongful termination, and breach of the implied covenant of good faith and fair dealing; (4) all tort claims, including claims for fraud, defamation, emotional distress, and discharge in violation of public policy; and (5) all federal, state, and local statutory claims, including claims for discrimination, harassment, retaliation, attorneys' fees, or other claims arising under the federal Civil Rights Act of 1964 (as amended), the federal Americans with Disabilities Act of 1990, the federal Age Discrimination in Employment Act of 1967 (as amended) ("**ADEA**"), the federal Executive Retirement Income Security Act of 1974 (as amended), and the California Fair Employment and Housing Act (as amended). Notwithstanding the foregoing, the following are not included in the Released Claims (the "**Excluded Claims**"): (1) any rights or claims for indemnification I may have pursuant to any written indemnification agreement with the Company to which I am a party, the charter or bylaws of the Company, or under applicable law; or (2) any rights which are not waivable as a matter of law. In addition, nothing in this Release prevents me from filing, cooperating with, or participating in any proceeding before the Equal Employment Opportunity Commission, the Department of Labor, the California Department of Fair Employment and Housing, or any other local, state, or federal administrative body or government agency that is authorized to enforce or administer laws related to employment, against the Company, except that I hereby waive my right to any monetary benefits in connection with any such claim, charge or proceeding. I hereby represent and warrant that, other than the Excluded Claims, I am not aware of any claims I have or might have against any of the Released Parties that are not included in the Released Claims.

I acknowledge that I am knowingly and voluntarily waiving and releasing any rights I may have under the ADEA. I also acknowledge that the consideration given for the Released Claims is in addition to anything of value to which I was already entitled. I further acknowledge that I have been advised by this writing, as required by the ADEA, that: (a) the Released Claims do not apply to any rights or claims that arise after the date I sign this Release; (b) I should consult with an attorney prior to signing this Release (although I may choose voluntarily not to do so); (c) I have twenty-one (21) days to consider this Release (although I may choose to voluntarily sign it sooner); (d) I have seven (7) days following the date I sign this Release to revoke the Release by providing written notice to an officer of the Company; and (e) the Release will not be effective until the date upon which the revocation period has expired unexercised, which will be the eighth day after I sign this Release (“*Effective Date*”).

I acknowledge that I have read and understand Section 1542 of the California Civil Code which reads as follows: “**A general release does not extend to claims which the creditor does not know or suspect to exist in his or her favor at the time of executing the release, which if known by him or her must have materially affected his or her settlement with the debtor.**” I hereby expressly waive and relinquish all rights and benefits under that section and any law of any jurisdiction of similar effect with respect to my release of any claims hereunder.

I hereby represent that I have been paid all compensation owed and for all hours worked, I have received all the leave and leave benefits and protections for which I am eligible, and I have not suffered any on-the-job injury for which I have not already filed a workers’ compensation claim.

I hereby agree not to disparage the Company, or its officers, directors, Executives, shareholders or agents, in any manner likely to be harmful to its or their business, business reputation, or personal reputation; *provided, however*, that I will respond accurately and fully to any question, inquiry or request for information when required by legal process.

I acknowledge that to become effective, I must sign and return this Release to the Company so that it is received not later than twenty-one (21) days following the date it is provided to me, and I must not revoke it thereafter.

MARTIN FORNAGE

Name: _____

Date: _____

ENPHASE ENERGY, INC.

CHANGE IN CONTROL AND SEVERANCE AGREEMENT

This Change in Control and Severance Agreement (the "**Agreement**") is dated as of June 14, 2011, by and between Jeff Loebbaka ("**Executive**") and Enphase Energy, Inc., a Delaware corporation (the "**Company**"). This Agreement is intended to provide Executive with certain benefits described herein upon the occurrence of specific events.

RECITALS

A. It is expected that another company may from time to time consider the possibility of acquiring the Company or that a Change in Control may otherwise occur, with or without the approval of the Company's Board of Directors (the "**Board**"). The Board recognizes that such consideration can be a distraction to Executive and can cause Executive to consider alternative employment opportunities. The Board has determined that it is in the best interests of the Company and its stockholders to assure that the Company will have the continued dedication and objectivity of the Executive, notwithstanding the possibility, threat or occurrence of a Change in Control (as defined below) of the Company.

B. The Company's Board believes it is in the best interests of the Company and its shareholders to retain Executive and provide incentives to Executive to continue in the service of the Company.

C. The Board further believes that it is imperative to provide Executive with certain benefits upon termination of Executive's employment in connection with a Change in Control, which benefits are intended to provide Executive with financial security and provide sufficient income and encouragement to Executive to remain with the Company, notwithstanding the possibility of a Change in Control.

D. To accomplish the foregoing objectives, the Board has directed the Company, upon execution of this Agreement by Executive, to agree to the terms provided in this Agreement.

Now therefore, in consideration of the mutual promises, covenants and agreements contained herein, and in consideration of the continuing employment of Executive by the Company, the parties hereto agree as follows:

1. At-Will Employment. Executive's employment is at-will, which means that the Company may terminate Executive's employment at any time, with or without advance notice, and with or without Cause. Similarly, Executive may resign Executive's employment at any time, with or without advance notice or Good Reason. Executive shall not receive any compensation of any kind, including, without limitation, equity award vesting acceleration and severance benefits, following Executive's last day of employment with the Company, except as expressly provided herein. Executive shall devote all reasonable efforts to the performance of Executive's duties, and shall perform such duties in good faith.

2. Benefits Upon Termination of Employment.

(a) **Termination in connection with or following a Change in Control.** If Executive's employment is terminated without Cause (and other than as a result of Executive's death or disability) or Executive resigns for Good Reason, in either case in connection with or within twenty four (24) months after a Change in Control, and provided such termination constitutes a "separation from service" (within the meaning of Treasury Regulation Section 1.409A-1(h), a "**Separation from Service**"), and provided Executive signs and allows to become effective a release substantially in the form attached hereto as **EXHIBIT A** or **EXHIBIT B**, as applicable (the "**Release**") within the time period provided therein, then the Company shall provide Executive with the following severance benefits (the "**Separation Benefits**"):

(i) The Company shall pay Executive an amount equal to three (3) months of Executive's then current base salary, ignoring any decrease in base salary that forms the basis for Good Reason, less all applicable withholdings and deductions, paid over such 3-month period (the "**Salary Continuation**"). The Salary Continuation will be paid in equal installments on the Company's regular payroll schedule and will be subject to applicable tax withholdings over the period outlined above following the date of Executive's Separation from Service as set forth in Section 3 below.

(ii) Should Executive elect to continue his health insurance benefits pursuant to the Consolidated Omnibus Budget Reconciliation Act of 1985 ("**COBRA**") and any analogous provisions of applicable state law, the Company shall pay Executive's COBRA group health insurance premiums for Executive and his eligible dependents for a period of three (3) months following the effective date of such termination of employment described in Section 2(a) (the "**COBRA Payment Period**"). References to COBRA premiums shall not include any amounts payable by Executive under an Internal Revenue Code Section 125 health care reimbursement plan. Notwithstanding the foregoing, if the Company determines, in its sole discretion, that the Company cannot provide the COBRA premium benefits without potentially incurring financial costs or penalties under applicable law (including, without limitation, Section 2716 of the Public Health Service Act), the Company shall in lieu thereof pay Executive a taxable cash amount, which payment shall be made regardless of whether Executive or Executive's eligible family members elect health care continuation coverage (the "**Health Care Benefit Payment**"). The Health Care Benefit Payment shall be paid in monthly installments on the same schedule that the COBRA Premiums would otherwise have been paid to the insurer. The Health Care Benefit Payment shall be equal to the amount that the Company would have otherwise paid for COBRA insurance premiums (which amount shall be calculated based on the premium for the first month of coverage), and shall be paid until the expiration of the COBRA Payment Period.

(iii) The vesting and/or exercisability of any outstanding equity awards held by Executive at the time of Executive's Separation from Service shall be accelerated as to 100% of the then unvested portions of such outstanding equity awards as of the date of Executive's Separation from Service.

3. Limitations And Conditions On Separation Benefits

(a) Release Prior to Payment of Benefits. Prior to the payment of any of the Separation Benefits, Executive shall execute, and allow to become effective, the Release within the time frame set forth therein, but not later than sixty (60) days following Executive's Separation from Service (the "**Release Effective Date**"). Such Release shall specifically relate to all of Executive's rights and claims in existence at the time of such execution and shall confirm Executive's continuing obligations to the Company (including but not limited to obligations under any confidentiality and/or non-solicitation agreement with the Company). No Separation Benefits will be paid prior to the Release Effective Date. Within five (5) days following the Release Effective Date, the Company will pay Executive the Separation Benefits Executive would otherwise have received on or prior to such date but for the delay in payment related to the effectiveness of the Release, with the balance of the benefits being paid as originally scheduled. Unless a Change in Control has occurred, the Board, in its sole discretion, may modify the form of the required Release to comply with applicable law and shall determine the form of the required Release, which may be incorporated into a termination agreement or other agreement with Executive. Notwithstanding the foregoing, if the Company (or, if applicable, the successor entity thereto) determines that any of the Separation Benefits constitute "deferred compensation" under Section 409A (defined below), then, solely to the extent necessary to avoid the incurrence of the adverse personal tax consequences under Section 409A, no Separation Benefits will be paid prior to the sixtieth (60th) day following Executive's Separation from Service. On the sixtieth (60th) day following the date of Separation from Service, the Company will pay to Executive in a lump sum the applicable Separation Benefits that Employee would otherwise have received on or prior to such date, with the balance of the Separation Benefits being paid as originally scheduled.

(b) Income and Employment Taxes. Executives agrees that Executive shall be responsible for any applicable taxes of any nature (including any penalties or interest that may apply to such taxes) that the Company reasonably determines apply to any payment made hereunder, that Executive's receipt of any benefit hereunder is conditioned on Executive's satisfaction of any applicable withholding or similar obligations that apply to such benefit, and that any cash payment owed hereunder will be reduced to satisfy any such withholding or similar obligations that may apply.

(c) Compliance with Section 409A. It is intended that each installment of the payments and benefits provided for in this Agreement is a separate "payment" for purposes of Treasury Regulation Section 1.409A-2(b)(2)(i). For the avoidance of doubt, it is intended that payments of the amounts set forth in this Agreement satisfy, to the greatest extent possible, the exemptions from the application of Section 409A of the Internal Revenue Code of 1986, as amended (the "**Code**") (Section 409A of the Code, together, with any state law of similar effect, "**Section 409A**") provided under Treasury Regulations 1.409A-1(b)(4), 1.409A-1(b)(5) and 1.409A-1(b)(9). However, if the Company (or, if applicable, the successor entity thereto) determines that the severance payments and benefits provided under this Agreement (the "**Agreement Payments**") constitute "deferred compensation" under Section 409A and Executive is, on the date of his Separation from Service, a "specified Executive" of the Company or any successor entity thereto, as such term is defined in Section 409A(a)(2)(B)(i) of the Code (a "**Specified Executive**"), then, solely to the extent necessary to avoid the incurrence of the adverse personal tax consequences under Section 409A, the timing of the Separation Benefit

described in Section 2(a)(i) shall be delayed as follows: on the earlier to occur of (i) the date that is six months and one day after Executive's Separation from Service or (ii) the date of Executive's death (such earlier date, the "**Delayed Initial Payment Date**"), the Company (or the successor entity thereto, as applicable) shall pay to Executive a lump sum amount equal to the applicable benefit that Executive would otherwise have received through the Delayed Initial Payment Date if the commencement of the payment of the benefit had not been so delayed pursuant to this Section 3(c).

(d) Conflicts. Executive represents that his performance of all the terms of this Agreement will not breach any other agreement to which Executive is a party. Executive has not, and will not during the term of this Agreement, enter into any oral or written agreement in conflict with any of the provisions of this Agreement. Executive further represents that Executive is entering into or has entered into an employment relationship with the Company of his own free will and that Executive has not been solicited as an employee in any way by the Company.

(e) Successors. Any successor to the Company (whether direct or indirect and whether by purchase, lease, merger, consolidation, liquidation or otherwise) to all or substantially all of the Company's business and/or assets shall assume the obligations under this Agreement and agree expressly to perform the obligations under this Agreement in the same manner and to the same extent as the Company would be required to perform such obligations in the absence of a succession. The terms of this Agreement and all of Executive's rights hereunder and thereunder shall inure to the benefit of, and be enforceable by, Executive's personal or legal representatives, executors, administrators, successors, heirs, distributees, devisees and legatees.

(f) Notice. Notices and all other communications contemplated by this Agreement shall be in writing and shall be deemed to have been duly given when personally delivered or when mailed by U.S. registered or certified mail, return receipt requested and postage prepaid. Mailed notices to Executive shall be addressed to Executive at the home address which Executive most recently communicated to the Company in writing. In the case of the Company, mailed notices shall be addressed to its corporate headquarters, and all notices shall be directed to the attention of its Chief Financial Officer.

4. Definitions.

(a) Cause. For purposes of this Agreement, "**Cause**", as determined by the Board acting in good faith and based on information then known to it, means: (A) gross negligence or willful misconduct in the performance of duties to the Company where such gross negligence or willful misconduct has resulted or is likely to result in substantial and material damage to the Company or its subsidiaries; (B) a material failure to comply with the Company's written policies after having received from the Company notice of, and a reasonable time to cure, such failure; (C) repeated unexplained or unjustified absence from the Company; (D) conviction of a felony or a crime involving moral turpitude causing material harm to the standing and reputation of the Company; or (E) unauthorized use or disclosure of any proprietary information or trade secrets of the Company or any other party to whom Executive owes an obligation of non-disclosure as a result of Executive's relationship with the Company, which use or disclosure causes or is likely to cause material harm to the Company.

(b) Good Reason. For purposes of this Agreement, “**Good Reason**” for Executive’s resignation of his employment will exist following the occurrence of any of the following without Executive’s written consent: (A) a material reduction or change in job duties, responsibilities or authority inconsistent with Executive’s position with the Company and Executive’s prior duties, responsibilities or authority, provided, however, that any change in Executive’s position after a Change in Control shall not constitute grounds for a termination for Good Reason so long as Executive remains a member of the Company’s senior management (or becomes a member of the senior management of the surviving or acquiring entity) at the same or higher base salary as immediately prior to the Change in Control with equivalent authority and responsibility; (B) a material reduction of Executive’s then current base salary, representing a reduction of more than 10 percent (10%), provided that an across-the-board reduction in the salary level of other executives of the Company by the same percentage amount as part of a general salary level reduction shall not constitute such a material salary reduction; (C) a relocation of the principal place for performance of Executive’s duties to the Company to a location more than forty (40) miles from the Company’s then current location; or (D) any material breach by the Company of this Agreement or Executive’s Employment Agreement (as defined below); provided that Executive gives written notice to the Company of the event forming the basis of the Good Reason resignation within sixty (60) days of the date the Company gives written notice to Executive of its affirmative decision to take an action set forth in (A), (B), (C) or (D) above, the Company fails to cure such basis for the Good Reason resignation within thirty (30) days after receipt of Executive’s written notice and Executive terminates his employment within thirty (30) days following the expiration of the cure period.

(c) Change in Control. For purposes of this Agreement, “**Change in Control**” means the occurrence of any of the following events: (i) any sale or exchange of the capital stock by the shareholders of the Company in one transaction or series of related transactions where more than 50% of the outstanding voting power of the Company is acquired by a person or entity or group of related persons or entities; or (ii) any reorganization, consolidation or merger of the Company where the outstanding voting securities of the Company immediately before the transaction represent or are converted into less than fifty percent 50% of the outstanding voting power of the surviving entity (or its parent corporation) immediately after the transaction; or (iii) the consummation of any transaction or series of related transactions that results in the sale of all or substantially all of the assets of the Company; or (iv) any “person” or “group” (as defined in the Securities Exchange Act of 1934, as amended (the “*Exchange Act*”)) becoming the “beneficial owner” (as defined in Rule 13d-3 under the Exchange Act) directly or indirectly of securities representing more than fifty percent (50%) of the voting power of the Company then outstanding.

5. Parachute Payments.

(a) If any payment or benefit (including payments and benefits pursuant to this Agreement) that Executive would receive in connection with a Change in Control from the Company or otherwise (“**Transaction Payment**”) would (i) constitute a “parachute payment” within the meaning of Section 280G of the Code, and (ii) but for this sentence, be subject to the excise tax imposed by Section 4999 of the Code (the “**Excise Tax**”), then the Company shall cause to be determined, before any amounts of the Transaction Payment are paid to Executive, which of the following two alternative forms of payment would result in Executive’s receipt, on an after-tax basis, of the greater amount of the Transaction Payment notwithstanding that all or

some portion of the Transaction Payment may be subject to the Excise Tax: (1) payment in full of the entire amount of the Transaction Payment (a “**Full Payment**”), or (2) payment of only a part of the Transaction Payment so that Executive receives the largest payment possible without the imposition of the Excise Tax (a “**Reduced Payment**”). For purposes of determining whether to make a Full Payment or a Reduced Payment, the Company shall cause to be taken into account all applicable federal, state and local income and employment taxes and the Excise Tax (all computed at the highest applicable marginal rate, net of the maximum reduction in federal income taxes which could be obtained from a deduction of such state and local taxes). If a Reduced Payment is made, (x) Executive shall have no rights to any additional payments and/or benefits constituting the Transaction Payment, and (y) reduction in payments and/or benefits shall occur in the manner that results in the greatest economic benefit to Executive as determined in this paragraph. If more than one method of reduction will result in the same economic benefit, the portions of the Transaction Payment shall be reduced pro rata.

(b) The professional firm engaged by the Company for general tax purposes as of the day prior to the effective date of the Change in Control shall make all determinations required to be made under this Section 5. If the professional firm so engaged by the Company is serving as accountant or auditor for the individual, entity or group effecting the Change in Control, the Company shall appoint a nationally recognized independent registered public accounting firm to make the determinations required hereunder. The Company shall bear all expenses with respect to the determinations by such professional firm required to be made hereunder.

(c) The professional firm engaged to make the determinations hereunder shall provide its calculations, together with detailed supporting documentation, to the Company and Executive within fifteen (15) calendar days after the date on which Executive’s right to a Transaction Payment is triggered or such other time as reasonably requested by the Company or Executive. If the professional firm determines that no Excise Tax is payable with respect to the Transaction Payment, either before or after the application of the Reduced Amount, it shall furnish the Company and Executive with detailed supporting calculations of its determinations that no Excise Tax will be imposed with respect to such Transaction Payment. Any good faith determinations of the professional firm made hereunder shall be final, binding and conclusive upon the Company and Executive.

6. Other Employment Terms and Conditions. The employment relationship between the parties shall be governed by the general employment policies and procedures of the Company, including those relating to the protection of confidential information and assignment of inventions; provided, however, that when the terms of this Agreement differ from or are in conflict with the Company’s general employment policies or procedures, this Agreement shall control.

7. Miscellaneous Provisions.

(a) **No Duty to Mitigate.** Executive shall not be required to mitigate the amount of any payment contemplated by this Agreement (whether by seeking new employment or in any other manner), nor shall any such payment be reduced by any earnings that Executive may receive from any other source.

(b) Waiver. No provision of this Agreement shall be modified, waived or discharged unless the modification, waiver or discharge is agreed to in writing and signed by Executive and by an authorized officer of the Company (other than Executive). No waiver by either party of any breach of, or of compliance with, any condition or provision of this Agreement by the other party shall be considered a waiver of any other condition or provision or of the same condition or provision at another time.

(c) Whole Agreement. No agreements, representations or understandings (whether oral or written and whether express or implied) which are not expressly set forth in this Agreement have been made or entered into by either party with respect to the subject matter hereof. This Agreement supersedes any agreement (or portion thereof) concerning similar subject matter dated prior to the date of this Agreement, including but not limited to Executive's offer letter with the Company dated April 19, 2010 (the "**Employment Agreement**"), and by execution of this Agreement both parties agree that any such predecessor agreement (or portion thereof) shall be deemed null and void. For the avoidance of doubt, the parties agree that this Agreement does not supersede the provisions of the Employee Agreement that do not address termination or severance benefits, the provisions of any equity plan of the Company that provides for vesting acceleration benefits on the event of a Change in Control in which the successor corporation does not assume or substitute for outstanding equity awards or Executive's Employee Invention Assignment and Confidentiality Agreement with the Company.

(d) Choice of Law. The validity, interpretation, construction and performance of this Agreement shall be governed by the laws of the State of California without reference to conflict of laws provisions.

(e) Severability. If any term or provision of this Agreement or the application thereof to any circumstance shall, in any jurisdiction and to any extent, be invalid or unenforceable, such term or provision shall be ineffective as to such jurisdiction to the extent of such invalidity or unenforceability without invalidating or rendering unenforceable the remaining terms and provisions of this Agreement or the application of such terms and provisions to circumstances other than those as to which it is held invalid or unenforceable, and a suitable and equitable term or provision shall be substituted therefor to carry out, insofar as may be valid and enforceable, the intent and purpose of the invalid or unenforceable term or provision.

(f) Arbitration. Executive and the Company agree to attempt to settle any disputes arising in connection with this Agreement through good faith consultation. In the event that Executive and the Company are not able to resolve any such disputes within fifteen (15) days after notification in writing to the other, Executive and the Company agree that any dispute or claim arising out of or in connection with this Agreement will be finally settled by binding arbitration in Sonoma County, California in accordance with the rules of the American Arbitration Association by one arbitrator mutually agreed upon by the parties. The arbitrator will apply California law, without reference to rules of conflicts of law or rules of statutory arbitration, to the resolution of any dispute. Except as set forth in Subparagraph (e) above, the arbitrator shall not have authority to modify the terms of this Agreement. The Company shall pay the costs of the arbitration proceeding. Each party shall, unless otherwise determined by the arbitrator, bear its or his own attorneys' fees and expenses, provided however that if Executive prevails in an arbitration proceeding, the Company shall reimburse Executive for his reasonable attorneys' fees and costs. Judgment on the award rendered by the arbitrator may be entered in

any court having jurisdiction thereof. Notwithstanding the foregoing, the Company and Executive may apply to any court of competent jurisdiction for preliminary or interim equitable relief, or to compel arbitration in accordance with this paragraph, without breach of this arbitration provision.

(g) Legal Fees and Expenses. The parties shall each bear their own expenses, legal fees and other fees incurred in connection with the execution of this Agreement.

(h) No Assignment of Benefits. The rights of any person to payments or benefits under this Agreement shall not be made subject to option or assignment, either by voluntary or involuntary assignment or by operation of law, including (without limitation) bankruptcy, garnishment, attachment or other creditor's process, and any action in violation of this Section 7(h) shall be void.

(i) Assignment by Company. The Company may assign its rights under this Agreement to an affiliate, and an affiliate may assign its rights under this Agreement to another affiliate of the Company or to the Company. In the case of any such assignment, the term "Company" when used in a section of this Agreement shall mean the corporation that actually employs the Executive.

(j) Counterparts. This Agreement may be executed in counterparts, each of which shall be deemed an original, but all of which together will constitute one and the same instrument.

IN WITNESS WHEREOF, the parties have executed this Agreement as of the date written below.

/s/ Jeff Loebbaka _____

JEFF LOEBBAKA

Address: _____

Date: 6/14/11 _____

ENPHASE ENERGY, INC.

/s/ Paul B. Nahi _____

Name: Paul Nahi

Title: Chief Executive Officer

Date: 6/14/11 _____

EXHIBIT A
RELEASE AGREEMENT

I understand and agree completely to the terms set forth in the Enphase Energy, Inc. Change in Control and Severance Agreement (the "**Agreement**").

I understand that this Release, together with the Agreement, constitutes the complete, final and exclusive embodiment of the entire agreement between the Company, affiliates of the Company and me with regard to the subject matter hereof. I am not relying on any promise or representation by the Company that is not expressly stated therein. Certain capitalized terms used in this Release are defined in the Agreement.

I hereby confirm my obligations under my Employee Invention Assignment and Confidentiality Agreement with the Company.

Except as otherwise set forth in this Release, I hereby generally and completely release the Company and its current and former directors, officers, Executives, shareholders, partners, agents, attorneys, predecessors, successors, parent and subsidiary entities, insurers, affiliates, and assigns (collectively, the "**Released Parties**") from any and all claims, liabilities and obligations, both known and unknown, that arise out of or are in any way related to events, acts, conduct, or omissions occurring prior to my signing this Release (collectively, the "**Released Claims**"). The Released Claims include, but are not limited to: (1) all claims arising out of or in any way related to my employment with the Company or its affiliates, or the termination of that employment; (2) all claims related to my compensation or benefits, including salary, bonuses, commissions, vacation pay, expense reimbursements, severance pay, fringe benefits, stock, stock options, or any other ownership interests in the Company or its affiliates; (3) all claims for breach of contract, wrongful termination, and breach of the implied covenant of good faith and fair dealing; (4) all tort claims, including claims for fraud, defamation, emotional distress, and discharge in violation of public policy; and (5) all federal, state, and local statutory claims, including claims for discrimination, harassment, retaliation, attorneys' fees, or other claims arising under the federal Civil Rights Act of 1964 (as amended), the federal Americans with Disabilities Act of 1990, the federal Age Discrimination in Employment Act of 1967 (as amended) ("**ADEA**"), the federal Employee Retirement Income Security Act of 1974 (as amended), and the California Fair Employment and Housing Act (as amended). Notwithstanding the foregoing, the following are not included in the Released Claims (the "**Excluded Claims**"): (1) any rights or claims for indemnification I may have pursuant to any written indemnification agreement with the Company to which I am a party, the charter or bylaws of the Company, or under applicable law; or (2) any rights which are not waivable as a matter of law. In addition, nothing in this Release prevents me from filing, cooperating with, or participating in any proceeding before the Equal Employment Opportunity Commission, the Department of Labor, the California Department of Fair Employment and Housing, or any other local, state, or federal administrative body or government agency that is authorized to enforce or administer laws related to employment, against the Company, except that I hereby waive my right to any monetary benefits in connection with any such claim, charge or proceeding. I hereby represent and warrant that, other than the Excluded Claims, I am not aware of any claims I have or might have against any of the Released Parties that are not included in the Released Claims.

I acknowledge that I am knowingly and voluntarily waiving and releasing any rights I may have under the ADEA. I also acknowledge that the consideration given for the Released Claims is in addition to anything of value to which I was already entitled. I further acknowledge that I have been advised by this writing, as required by the ADEA, that: (a) the Released Claims do not apply to any rights or claims that arise after the date I sign this Release; (b) I should consult with an attorney prior to signing this Release (although I may choose voluntarily not to do so); (c) I have forty-five (45) days to consider this Release (although I may choose to voluntarily sign it sooner); (d) I have seven (7) days following the date I sign this Release to revoke the Release by providing written notice to an officer of the Company; and (e) the Release will not be effective until the date upon which the revocation period has expired unexercised, which will be the eighth day after I sign this Release ("**Effective Date**").

I have received with this Release all of the information required by the ADEA, including without limitation a detailed list of the job titles and ages of all Executives who were terminated in this group termination and the ages of all Executives of the Company in the same job classification or organizational unit who were not terminated, along with information on the eligibility factors used to select Executives for the group termination and any time limits applicable to this group termination program.

I acknowledge that I have read and understand Section 1542 of the California Civil Code which reads as follows: "**A general release does not extend to claims which the creditor does not know or suspect to exist in his or her favor at the time of executing the release, which if known by him or her must have materially affected his or her settlement with the debtor.**" I hereby expressly waive and relinquish all rights and benefits under that section and any law of any jurisdiction of similar effect with respect to my release of any claims hereunder.

I hereby represent that I have been paid all compensation owed and for all hours worked, I have received all the leave and leave benefits and protections for which I am eligible, and I have not suffered any on-the-job injury for which I have not already filed a workers' compensation claim.

I hereby agree not to disparage the Company, or its officers, directors, Executives, shareholders or agents, in any manner likely to be harmful to its or their business, business reputation, or personal reputation; *provided, however*, that I will respond accurately and fully to any question, inquiry or request for information when required by legal process.

I acknowledge that to become effective, I must sign and return this Release to the Company so that it is received not later than forty-five (45) days following the date it is provided to me, and I must not revoke it thereafter.

JEFF LOEBBAKA

Date: _____

EXHIBIT B
RELEASE AGREEMENT

I understand and agree completely to the terms set forth in the Enphase Energy, Inc. Change in Control and Severance Agreement (the "**Agreement**").

I understand that this Release, together with the Agreement, constitutes the complete, final and exclusive embodiment of the entire agreement between the Company, affiliates of the Company and me with regard to the subject matter hereof. I am not relying on any promise or representation by the Company that is not expressly stated therein. Certain capitalized terms used in this Release are defined in the Agreement.

I hereby confirm my obligations under my Employee Invention Assignment and Confidentiality Agreement with the Company.

Except as otherwise set forth in this Release, I hereby generally and completely release the Company and its current and former directors, officers, Executives, shareholders, partners, agents, attorneys, predecessors, successors, parent and subsidiary entities, insurers, affiliates, and assigns (collectively, the "**Released Parties**") from any and all claims, liabilities and obligations, both known and unknown, that arise out of or are in any way related to events, acts, conduct, or omissions occurring prior to my signing this Release (collectively, the "**Released Claims**"). The Released Claims include, but are not limited to: (1) all claims arising out of or in any way related to my employment with the Company or its affiliates, or the termination of that employment; (2) all claims related to my compensation or benefits, including salary, bonuses, commissions, vacation pay, expense reimbursements, severance pay, fringe benefits, stock, stock options, or any other ownership interests in the Company or its affiliates; (3) all claims for breach of contract, wrongful termination, and breach of the implied covenant of good faith and fair dealing; (4) all tort claims, including claims for fraud, defamation, emotional distress, and discharge in violation of public policy; and (5) all federal, state, and local statutory claims, including claims for discrimination, harassment, retaliation, attorneys' fees, or other claims arising under the federal Civil Rights Act of 1964 (as amended), the federal Americans with Disabilities Act of 1990, the federal Age Discrimination in Employment Act of 1967 (as amended) ("**ADEA**"), the federal Executive Retirement Income Security Act of 1974 (as amended), and the California Fair Employment and Housing Act (as amended). Notwithstanding the foregoing, the following are not included in the Released Claims (the "**Excluded Claims**"): (1) any rights or claims for indemnification I may have pursuant to any written indemnification agreement with the Company to which I am a party, the charter or bylaws of the Company, or under applicable law; or (2) any rights which are not waivable as a matter of law. In addition, nothing in this Release prevents me from filing, cooperating with, or participating in any proceeding before the Equal Employment Opportunity Commission, the Department of Labor, the California Department of Fair Employment and Housing, or any other local, state, or federal administrative body or government agency that is authorized to enforce or administer laws related to employment, against the Company, except that I hereby waive my right to any monetary benefits in connection with any such claim, charge or proceeding. I hereby represent

and warrant that, other than the Excluded Claims, I am not aware of any claims I have or might have against any of the Released Parties that are not included in the Released Claims.

I acknowledge that I am knowingly and voluntarily waiving and releasing any rights I may have under the ADEA. I also acknowledge that the consideration given for the Released Claims is in addition to anything of value to which I was already entitled. I further acknowledge that I have been advised by this writing, as required by the ADEA, that: (a) the Released Claims do not apply to any rights or claims that arise after the date I sign this Release; (b) I should consult with an attorney prior to signing this Release (although I may choose voluntarily not to do so); (c) I have twenty-one (21) days to consider this Release (although I may choose to voluntarily sign it sooner); (d) I have seven (7) days following the date I sign this Release to revoke the Release by providing written notice to an officer of the Company; and (e) the Release will not be effective until the date upon which the revocation period has expired unexercised, which will be the eighth day after I sign this Release ("**Effective Date**").

I acknowledge that I have read and understand Section 1542 of the California Civil Code which reads as follows: "**A general release does not extend to claims which the creditor does not know or suspect to exist in his or her favor at the time of executing the release, which if known by him or her must have materially affected his or her settlement with the debtor.**" I hereby expressly waive and relinquish all rights and benefits under that section and any law of any jurisdiction of similar effect with respect to my release of any claims hereunder.

I hereby represent that I have been paid all compensation owed and for all hours worked, I have received all the leave and leave benefits and protections for which I am eligible, and I have not suffered any on-the-job injury for which I have not already filed a workers' compensation claim.

I hereby agree not to disparage the Company, or its officers, directors, Executives, shareholders or agents, in any manner likely to be harmful to its or their business, business reputation, or personal reputation; *provided, however*, that I will respond accurately and fully to any question, inquiry or request for information when required by legal process.

I acknowledge that to become effective, I must sign and return this Release to the Company so that it is received not later than twenty-one (21) days following the date it is provided to me, and I must not revoke it thereafter.

JEFF LOEBBAKA

Date: _____

ENPHASE ENERGY, INC.

EXECUTIVE SEVERANCE AGREEMENT

This Executive Severance Agreement (the “**Agreement**”) is dated as of June 14, 2011, by and between Raghuv eer R. Belur (“**Executive**”) and Enphase Energy, Inc., a Delaware corporation (the “**Company**”). This Agreement is intended to provide Executive with certain benefits described herein upon the occurrence of specific events.

RECITALS

A. The Company’s Board of Directors (the “**Board**”) believes it is in the best interests of the Company and its stockholders to retain Executive and provide incentives to Executive to continue in the service of the Company.

B. The Board further believes that it is imperative to provide Executive with certain benefits upon termination of Executive’s employment, which benefits are intended to provide Executive with financial security and provide sufficient income and encouragement to Executive to remain with the Company.

C. To accomplish the foregoing objectives, the Board has directed the Company, upon execution of this Agreement by Executive, to agree to the terms provided in this Agreement.

Now therefore, in consideration of the mutual promises, covenants and agreements contained herein, and in consideration of the continuing employment of Executive by the Company, the parties hereto agree as follows:

1. At-Will Employment. Executive’s employment is at-will, which means that the Company may terminate Executive’s employment at any time, with or without advance notice, and with or without Cause. Similarly, Executive may resign Executive’s employment at any time, with or without advance notice or Good Reason. Executive shall not receive any compensation of any kind, including, without limitation, equity award vesting acceleration and severance benefits, following Executive’s last day of employment with the Company, except as expressly provided herein. Executive shall devote all reasonable efforts to the performance of Executive’s duties, and shall perform such duties in good faith.

2. Benefits Upon Termination of Employment. If Executive’s employment is terminated without Cause (and other than as a result of Executive’s death or disability) or Executive resigns for Good Reason, and provided such termination constitutes a “separation from service” (within the meaning of Treasury Regulation Section 1.409A-1(h), a “**Separation from Service**”), and provided Executive signs and allows to become effective a release substantially in the form attached hereto as **EXHIBIT A** or **EXHIBIT B**, as applicable (the “**Release**”) within the time period provided therein, then the Company shall provide Executive with the following severance benefits (the “**Separation Benefits**”):

1.

(a) The Company shall pay Executive an amount equal to six (6) months of Executive's then current base salary and annual cash bonus (if any), ignoring any decrease in base salary that forms the basis for Good Reason, less all applicable withholdings and deductions, paid over such 6-month period (the "**Salary Continuation**"). The Salary Continuation will be paid in equal installments on the Company's regular payroll schedule and will be subject to applicable tax withholdings over the period outlined above following the date of Executive's Separation from Service as set forth in Section 3 below.

(b) Should Executive elect to continue his health insurance benefits pursuant to the Consolidated Omnibus Budget Reconciliation Act of 1985 ("**COBRA**") and any analogous provisions of applicable state law, the Company shall pay Executive's COBRA group health insurance premiums for Executive and his eligible dependents for a period of six (6) months following the effective date of such termination of employment described in Section 2(a) (the "**COBRA Payment Period**"). References to COBRA premiums shall not include any amounts payable by Executive under an Internal Revenue Code Section 125 health care reimbursement plan. Notwithstanding the foregoing, if the Company determines, in its sole discretion, that the Company cannot provide the COBRA premium benefits without potentially incurring financial costs or penalties under applicable law (including, without limitation, Section 2716 of the Public Health Service Act), the Company shall in lieu thereof pay Executive a taxable cash amount, which payment shall be made regardless of whether Executive or Executive's eligible family members elect health care continuation coverage (the "**Health Care Benefit Payment**"). The Health Care Benefit Payment shall be paid in monthly installments on the same schedule that the COBRA Premiums would otherwise have been paid to the insurer. The Health Care Benefit Payment shall be equal to the amount that the Company would have otherwise paid for COBRA insurance premiums (which amount shall be calculated based on the premium for the first month of coverage), and shall be paid until the expiration of the COBRA Payment Period.

(c) The vesting and/or exercisability of any outstanding equity awards held by Executive at the time of Executive's Separation from Service shall be accelerated as to 100% of the then unvested portions of such outstanding equity awards as of the date of Executive's Separation from Service.

3. Limitations And Conditions On Separation Benefits

(a) **Release Prior to Payment of Benefits.** Prior to the payment of any of the Separation Benefits, Executive shall execute, and allow to become effective, the Release within the time frame set forth therein, but not later than sixty (60) days following Executive's Separation from Service (the "**Release Effective Date**"). Such Release shall specifically relate to all of Executive's rights and claims in existence at the time of such execution and shall confirm Executive's continuing obligations to the Company (including but not limited to obligations under any confidentiality and/or non-solicitation agreement with the Company). No Separation Benefits will be paid prior to the Release Effective Date. Within five (5) days following the Release Effective Date, the Company will pay Executive the Separation Benefits Executive would otherwise have received on or prior to such date but for the delay in payment related to the effectiveness of the Release, with the balance of the benefits being paid as originally scheduled. Unless a Separation from Service has occurred, the Board, in its sole discretion, may modify the form of the required Release to comply with applicable law and shall determine the form of the

required Release, which may be incorporated into a termination agreement or other agreement with Executive. Notwithstanding the foregoing, if the Company (or, if applicable, the successor entity thereto) determines that any of the Separation Benefits constitute “deferred compensation” under Section 409A (defined below), then, solely to the extent necessary to avoid the incurrence of the adverse personal tax consequences under Section 409A, no Separation Benefits will be paid prior to the sixtieth (60th) day following Executive’s Separation from Service. On the sixtieth (60th) day following the date of Separation from Service, the Company will pay to Executive in a lump sum the applicable Separation Benefits that Employee would otherwise have received on or prior to such date, with the balance of the Separation Benefits being paid as originally scheduled.

(b) Income and Employment Taxes. Executives agrees that Executive shall be responsible for any applicable taxes of any nature (including any penalties or interest that may apply to such taxes) that the Company reasonably determines apply to any payment made hereunder, that Executive’s receipt of any benefit hereunder is conditioned on Executive’s satisfaction of any applicable withholding or similar obligations that apply to such benefit, and that any cash payment owed hereunder will be reduced to satisfy any such withholding or similar obligations that may apply.

(c) Compliance with Section 409A. It is intended that each installment of the payments and benefits provided for in this Agreement is a separate “payment” for purposes of Treasury Regulation Section 1.409A-2(b)(2)(i). For the avoidance of doubt, it is intended that payments of the amounts set forth in this Agreement satisfy, to the greatest extent possible, the exemptions from the application of Section 409A of the Internal Revenue Code of 1986, as amended (the “Code”) (Section 409A of the Code, together, with any state law of similar effect, “Section 409A”) provided under Treasury Regulations 1.409A-1(b)(4), 1.409A-1(b)(5) and 1.409A-1(b)(9). However, if the Company (or, if applicable, the successor entity thereto) determines that the severance payments and benefits provided under this Agreement (the “Agreement Payments”) constitute “deferred compensation” under Section 409A and Executive is, on the date of his Separation from Service, a “specified Executive” of the Company or any successor entity thereto, as such term is defined in Section 409A(a)(2)(B)(i) of the Code (a “Specified Executive”), then, solely to the extent necessary to avoid the incurrence of the adverse personal tax consequences under Section 409A, the timing of the Separation Benefit described in Section 2(a) shall be delayed as follows: on the earlier to occur of (i) the date that is six months and one day after Executive’s Separation from Service or (ii) the date of Executive’s death (such earlier date, the “Delayed Initial Payment Date”), the Company (or the successor entity thereto, as applicable) shall pay to Executive a lump sum amount equal to the applicable benefit that Executive would otherwise have received through the Delayed Initial Payment Date if the commencement of the payment of the benefit had not been so delayed pursuant to this Section 3(c).

(d) Conflicts. Executive represents that his performance of all the terms of this Agreement will not breach any other agreement to which Executive is a party. Executive has not, and will not during the term of this Agreement, enter into any oral or written agreement in conflict with any of the provisions of this Agreement. Executive further represents that Executive is entering into or has entered into an employment relationship with the Company of

his own free will and that Executive has not been solicited as an employee in any way by the Company.

(e) Successors. Any successor to the Company (whether direct or indirect and whether by purchase, lease, merger, consolidation, liquidation or otherwise) to all or substantially all of the Company's business and/or assets shall assume the obligations under this Agreement and agree expressly to perform the obligations under this Agreement in the same manner and to the same extent as the Company would be required to perform such obligations in the absence of a succession. The terms of this Agreement and all of Executive's rights hereunder and thereunder shall inure to the benefit of, and be enforceable by, Executive's personal or legal representatives, executors, administrators, successors, heirs, distributees, devisees and legatees.

(f) Notice. Notices and all other communications contemplated by this Agreement shall be in writing and shall be deemed to have been duly given when personally delivered or when mailed by U.S. registered or certified mail, return receipt requested and postage prepaid. Mailed notices to Executive shall be addressed to Executive at the home address which Executive most recently communicated to the Company in writing. In the case of the Company, mailed notices shall be addressed to its corporate headquarters, and all notices shall be directed to the attention of its Chief Financial Officer.

4. Definitions.

(a) Cause. For purposes of this Agreement, "Cause", as determined by the Board acting in good faith and based on information then known to it, means: (A) gross negligence or willful misconduct in the performance of duties to the Company where such gross negligence or willful misconduct has resulted or is likely to result in substantial and material damage to the Company or its subsidiaries; (B) a material failure to comply with the Company's written policies after having received from the Company notice of, and a reasonable time to cure, such failure; (C) repeated unexplained or unjustified absence from the Company; (D) conviction of a felony or a crime involving moral turpitude causing material harm to the standing and reputation of the Company; or (E) unauthorized use or disclosure of any proprietary information or trade secrets of the Company or any other party to whom Executive owes an obligation of non-disclosure as a result of Executive's relationship with the Company, which use or disclosure causes or is likely to cause material harm to the Company.

(b) Good Reason. For purposes of this Agreement, "**Good Reason**" for Executive's resignation of his employment will exist following the occurrence of any of the following without Executive's written consent: (A) a material reduction or change in job duties, responsibilities or authority inconsistent with Executive's position with the Company and Executive's prior duties, responsibilities or authority, provided, however, that any change in Executive's position after a Change in Control shall not constitute grounds for a termination for Good Reason so long as Executive remains a member of the Company's senior management (or becomes a member of the senior management of the surviving or acquiring entity) at the same or higher base salary as immediately prior to the Change in Control with equivalent authority and responsibility; (B) a material reduction of Executive's then current base salary, representing a reduction of more than 10 percent (10%), provided that an across-the-board reduction in the salary level of other executives of the Company by the same percentage amount as part of a

general salary level reduction shall not constitute such a material salary reduction; (C) a relocation of the principal place for performance of Executive's duties to the Company to a location more than forty (40) miles from the Company's then current location; or (D) any material breach by the Company of this Agreement or Executive's Employment Agreement (as defined below); provided that Executive gives written notice to the Company of the event forming the basis of the Good Reason resignation within sixty (60) days of the date the Company gives written notice to Executive of its affirmative decision to take an action set forth in (A), (B), (C) or (D) above, the Company fails to cure such basis for the Good Reason resignation within thirty (30) days after receipt of Executive's written notice and Executive terminates his employment within thirty (30) days following the expiration of the cure period.

(c) Change in Control. For purposes of this Agreement, "**Change in Control**" means the occurrence of any of the following events: (i) any sale or exchange of the capital stock by the shareholders of the Company in one transaction or series of related transactions where more than 50% of the outstanding voting power of the Company is acquired by a person or entity or group of related persons or entities; or (ii) any reorganization, consolidation or merger of the Company where the outstanding voting securities of the Company immediately before the transaction represent or are converted into less than fifty percent 50% of the outstanding voting power of the surviving entity (or its parent corporation) immediately after the transaction; or (iii) the consummation of any transaction or series of related transactions that results in the sale of all or substantially all of the assets of the Company; or (iv) any "person" or "group" (as defined in the Securities Exchange Act of 1934, as amended (the "*Exchange Act*")) becoming the "beneficial owner" (as defined in Rule 13d-3 under the Exchange Act) directly or indirectly of securities representing more than fifty percent (50%) of the voting power of the Company then outstanding.

5. Parachute Payments.

(a) If any payment or benefit (including payments and benefits pursuant to this Agreement) that Executive would receive in connection with a Change in Control from the Company or otherwise ("**Transaction Payment**") would (i) constitute a "parachute payment" within the meaning of Section 280G of the Code, and (ii) but for this sentence, be subject to the excise tax imposed by Section 4999 of the Code (the "**Excise Tax**"), then the Company shall cause to be determined, before any amounts of the Transaction Payment are paid to Executive, which of the following two alternative forms of payment would result in Executive's receipt, on an after-tax basis, of the greater amount of the Transaction Payment notwithstanding that all or some portion of the Transaction Payment may be subject to the Excise Tax: (1) payment in full of the entire amount of the Transaction Payment (a "**Full Payment**"), or (2) payment of only a part of the Transaction Payment so that Executive receives the largest payment possible without the imposition of the Excise Tax (a "**Reduced Payment**"). For purposes of determining whether to make a Full Payment or a Reduced Payment, the Company shall cause to be taken into account all applicable federal, state and local income and employment taxes and the Excise Tax (all computed at the highest applicable marginal rate, net of the maximum reduction in federal income taxes which could be obtained from a deduction of such state and local taxes). If a Reduced Payment is made, (x) Executive shall have no rights to any additional payments and/or benefits constituting the Transaction Payment, and (y) reduction in payments and/or benefits shall occur in the manner that results in the greatest economic benefit to Executive as determined

in this paragraph. If more than one method of reduction will result in the same economic benefit, the portions of the Transaction Payment shall be reduced pro rata.

(b) The professional firm engaged by the Company for general tax purposes as of the day prior to the effective date of the Change in Control shall make all determinations required to be made under this Section 5. If the professional firm so engaged by the Company is serving as accountant or auditor for the individual, entity or group effecting the Change in Control, the Company shall appoint a nationally recognized independent registered public accounting firm to make the determinations required hereunder. The Company shall bear all expenses with respect to the determinations by such professional firm required to be made hereunder.

(c) The professional firm engaged to make the determinations hereunder shall provide its calculations, together with detailed supporting documentation, to the Company and Executive within fifteen (15) calendar days after the date on which Executive's right to a Transaction Payment is triggered or such other time as reasonably requested by the Company or Executive. If the professional firm determines that no Excise Tax is payable with respect to the Transaction Payment, either before or after the application of the Reduced Amount, it shall furnish the Company and Executive with detailed supporting calculations of its determinations that no Excise Tax will be imposed with respect to such Transaction Payment. Any good faith determinations of the professional firm made hereunder shall be final, binding and conclusive upon the Company and Executive.

6. Other Employment Terms and Conditions. The employment relationship between the parties shall be governed by the general employment policies and procedures of the Company, including those relating to the protection of confidential information and assignment of inventions; provided, however, that when the terms of this Agreement differ from or are in conflict with the Company's general employment policies or procedures, this Agreement shall control.

7. Miscellaneous Provisions.

(a) **No Duty to Mitigate.** Executive shall not be required to mitigate the amount of any payment contemplated by this Agreement (whether by seeking new employment or in any other manner), nor shall any such payment be reduced by any earnings that Executive may receive from any other source.

(b) **Waiver.** No provision of this Agreement shall be modified, waived or discharged unless the modification, waiver or discharge is agreed to in writing and signed by Executive and by an authorized officer of the Company (other than Executive). No waiver by either party of any breach of, or of compliance with, any condition or provision of this Agreement by the other party shall be considered a waiver of any other condition or provision or of the same condition or provision at another time.

(c) **Whole Agreement.** No agreements, representations or understandings (whether oral or written and whether express or implied) which are not expressly set forth in this Agreement have been made or entered into by either party with respect to the subject matter

hereof. This Agreement supersedes any agreement (or portion thereof) concerning similar subject matter dated prior to the date of this Agreement, including but not limited to Executive's Employment Agreement with the Company dated as of March 1, 2006, as amended (the "**Employment Agreement**"), and by execution of this Agreement both parties agree that any such predecessor agreement (or portion thereof) shall be deemed null and void. For the avoidance of doubt, the parties agree that this Agreement does not supersede the provisions of the Employment Agreement other than the sections related to "Constructive Termination" and "Termination without Cause" (as such terms are defined in the Employment Agreement), the provisions of any equity plan of the Company that provides for vesting acceleration benefits on the event of a Change in Control in which the successor corporation does not assume or substitute for outstanding equity awards or Executive's Employee Invention Assignment and Confidentiality Agreement with the Company.

(d) Choice of Law. The validity, interpretation, construction and performance of this Agreement shall be governed by the laws of the State of California without reference to conflict of laws provisions.

(e) Severability. If any term or provision of this Agreement or the application thereof to any circumstance shall, in any jurisdiction and to any extent, be invalid or unenforceable, such term or provision shall be ineffective as to such jurisdiction to the extent of such invalidity or unenforceability without invalidating or rendering unenforceable the remaining terms and provisions of this Agreement or the application of such terms and provisions to circumstances other than those as to which it is held invalid or unenforceable, and a suitable and equitable term or provision shall be substituted therefor to carry out, insofar as may be valid and enforceable, the intent and purpose of the invalid or unenforceable term or provision.

(f) Arbitration. Executive and the Company agree to attempt to settle any disputes arising in connection with this Agreement through good faith consultation. In the event that Executive and the Company are not able to resolve any such disputes within fifteen (15) days after notification in writing to the other, Executive and the Company agree that any dispute or claim arising out of or in connection with this Agreement will be finally settled by binding arbitration in Sonoma County, California in accordance with the rules of the American Arbitration Association by one arbitrator mutually agreed upon by the parties. The arbitrator will apply California law, without reference to rules of conflicts of law or rules of statutory arbitration, to the resolution of any dispute. Except as set forth in Subparagraph (e) above, the arbitrator shall not have authority to modify the terms of this Agreement. The Company shall pay the costs of the arbitration proceeding. Each party shall, unless otherwise determined by the arbitrator, bear its or his own attorneys' fees and expenses, provided however that if Executive prevails in an arbitration proceeding, the Company shall reimburse Executive for his reasonable attorneys' fees and costs. Judgment on the award rendered by the arbitrator may be entered in any court having jurisdiction thereof. Notwithstanding the foregoing, the Company and Executive may apply to any court of competent jurisdiction for preliminary or interim equitable relief, or to compel arbitration in accordance with this paragraph, without breach of this arbitration provision.

(g) Legal Fees and Expenses. The parties shall each bear their own expenses, legal fees and other fees incurred in connection with the execution of this Agreement.

(h) No Assignment of Benefits. The rights of any person to payments or benefits under this Agreement shall not be made subject to option or assignment, either by voluntary or involuntary assignment or by operation of law, including (without limitation) bankruptcy, garnishment, attachment or other creditor's process, and any action in violation of this Section 7(h) shall be void.

(i) Assignment by Company. The Company may assign its rights under this Agreement to an affiliate, and an affiliate may assign its rights under this Agreement to another affiliate of the Company or to the Company. In the case of any such assignment, the term "Company" when used in a section of this Agreement shall mean the corporation that actually employs the Executive.

(j) Counterparts. This Agreement may be executed in counterparts, each of which shall be deemed an original, but all of which together will constitute one and the same instrument.

IN WITNESS WHEREOF, the parties have executed this Agreement as of the date written below.

/s/ Raghuvveer R. Belur

RAGHUVVEER R. BELUR

Address: _____

Date: 6/14/11

ENPHASE ENERGY, INC.

/s/ Paul B. Nahi

Name: Paul Nahi

Title: Chief Executive Officer

Date: 6/14/11

EXHIBIT A
RELEASE AGREEMENT

I understand and agree completely to the terms set forth in the Enphase Energy, Inc. Executive Severance Agreement (the "**Agreement**").

I understand that this Release, together with the Agreement, constitutes the complete, final and exclusive embodiment of the entire agreement between the Company, affiliates of the Company and me with regard to the subject matter hereof. I am not relying on any promise or representation by the Company that is not expressly stated therein. Certain capitalized terms used in this Release are defined in the Agreement.

I hereby confirm my obligations under my Employee Invention Assignment and Confidentiality Agreement with the Company.

Except as otherwise set forth in this Release, I hereby generally and completely release the Company and its current and former directors, officers, Executives, shareholders, partners, agents, attorneys, predecessors, successors, parent and subsidiary entities, insurers, affiliates, and assigns (collectively, the "**Released Parties**") from any and all claims, liabilities and obligations, both known and unknown, that arise out of or are in any way related to events, acts, conduct, or omissions occurring prior to my signing this Release (collectively, the "**Released Claims**"). The Released Claims include, but are not limited to: (1) all claims arising out of or in any way related to my employment with the Company or its affiliates, or the termination of that employment; (2) all claims related to my compensation or benefits, including salary, bonuses, commissions, vacation pay, expense reimbursements, severance pay, fringe benefits, stock, stock options, or any other ownership interests in the Company or its affiliates; (3) all claims for breach of contract, wrongful termination, and breach of the implied covenant of good faith and fair dealing; (4) all tort claims, including claims for fraud, defamation, emotional distress, and discharge in violation of public policy; and (5) all federal, state, and local statutory claims, including claims for discrimination, harassment, retaliation, attorneys' fees, or other claims arising under the federal Civil Rights Act of 1964 (as amended), the federal Americans with Disabilities Act of 1990, the federal Age Discrimination in Employment Act of 1967 (as amended) ("**ADEA**"), the federal Employee Retirement Income Security Act of 1974 (as amended), and the California Fair Employment and Housing Act (as amended). Notwithstanding the foregoing, the following are not included in the Released Claims (the "**Excluded Claims**"): (1) any rights or claims for indemnification I may have pursuant to any written indemnification agreement with the Company to which I am a party, the charter or bylaws of the Company, or under applicable law; or (2) any rights which are not waivable as a matter of law. In addition, nothing in this Release prevents me from filing, cooperating with, or participating in any proceeding before the Equal Employment Opportunity Commission, the Department of Labor, the California Department of Fair Employment and Housing, or any other local, state, or federal administrative body or government agency that is authorized to enforce or administer laws related to employment, against the Company, except that I hereby waive my right to any monetary benefits in connection with any such claim, charge or proceeding. I hereby represent

and warrant that, other than the Excluded Claims, I am not aware of any claims I have or might have against any of the Released Parties that are not included in the Released Claims.

I acknowledge that I am knowingly and voluntarily waiving and releasing any rights I may have under the ADEA. I also acknowledge that the consideration given for the Released Claims is in addition to anything of value to which I was already entitled. I further acknowledge that I have been advised by this writing, as required by the ADEA, that: (a) the Released Claims do not apply to any rights or claims that arise after the date I sign this Release; (b) I should consult with an attorney prior to signing this Release (although I may choose voluntarily not to do so); (c) I have forty-five (45) days to consider this Release (although I may choose to voluntarily sign it sooner); (d) I have seven (7) days following the date I sign this Release to revoke the Release by providing written notice to an officer of the Company; and (e) the Release will not be effective until the date upon which the revocation period has expired unexercised, which will be the eighth day after I sign this Release (“**Effective Date**”).

I have received with this Release all of the information required by the ADEA, including without limitation a detailed list of the job titles and ages of all Executives who were terminated in this group termination and the ages of all Executives of the Company in the same job classification or organizational unit who were not terminated, along with information on the eligibility factors used to select Executives for the group termination and any time limits applicable to this group termination program.

I acknowledge that I have read and understand Section 1542 of the California Civil Code which reads as follows: “**A general release does not extend to claims which the creditor does not know or suspect to exist in his or her favor at the time of executing the release, which if known by him or her must have materially affected his or her settlement with the debtor.**” I hereby expressly waive and relinquish all rights and benefits under that section and any law of any jurisdiction of similar effect with respect to my release of any claims hereunder.

I hereby represent that I have been paid all compensation owed and for all hours worked, I have received all the leave and leave benefits and protections for which I am eligible, and I have not suffered any on-the-job injury for which I have not already filed a workers’ compensation claim.

I hereby agree not to disparage the Company, or its officers, directors, Executives, shareholders or agents, in any manner likely to be harmful to its or their business, business reputation, or personal reputation; *provided, however*, that I will respond accurately and fully to any question, inquiry or request for information when required by legal process.

I acknowledge that to become effective, I must sign and return this Release to the Company so that it is received not later than forty-five (45) days following the date it is provided to me, and I must not revoke it thereafter.

RAGHUVeer R. BELUR

Name: _____

Date: _____

3.

EXHIBIT B
RELEASE AGREEMENT

I understand and agree completely to the terms set forth in the Enphase Energy, Inc. Executive Severance Agreement (the "**Agreement**").

I understand that this Release, together with the Agreement, constitutes the complete, final and exclusive embodiment of the entire agreement between the Company, affiliates of the Company and me with regard to the subject matter hereof. I am not relying on any promise or representation by the Company that is not expressly stated therein. Certain capitalized terms used in this Release are defined in the Agreement.

I hereby confirm my obligations under my Employee Invention Assignment and Confidentiality Agreement with the Company.

Except as otherwise set forth in this Release, I hereby generally and completely release the Company and its current and former directors, officers, Executives, shareholders, partners, agents, attorneys, predecessors, successors, parent and subsidiary entities, insurers, affiliates, and assigns (collectively, the "**Released Parties**") from any and all claims, liabilities and obligations, both known and unknown, that arise out of or are in any way related to events, acts, conduct, or omissions occurring prior to my signing this Release (collectively, the "**Released Claims**"). The Released Claims include, but are not limited to: (1) all claims arising out of or in any way related to my employment with the Company or its affiliates, or the termination of that employment; (2) all claims related to my compensation or benefits, including salary, bonuses, commissions, vacation pay, expense reimbursements, severance pay, fringe benefits, stock, stock options, or any other ownership interests in the Company or its affiliates; (3) all claims for breach of contract, wrongful termination, and breach of the implied covenant of good faith and fair dealing; (4) all tort claims, including claims for fraud, defamation, emotional distress, and discharge in violation of public policy; and (5) all federal, state, and local statutory claims, including claims for discrimination, harassment, retaliation, attorneys' fees, or other claims arising under the federal Civil Rights Act of 1964 (as amended), the federal Americans with Disabilities Act of 1990, the federal Age Discrimination in Employment Act of 1967 (as amended) ("**ADEA**"), the federal Executive Retirement Income Security Act of 1974 (as amended), and the California Fair Employment and Housing Act (as amended). Notwithstanding the foregoing, the following are not included in the Released Claims (the "**Excluded Claims**"): (1) any rights or claims for indemnification I may have pursuant to any written indemnification agreement with the Company to which I am a party, the charter or bylaws of the Company, or under applicable law; or (2) any rights which are not waivable as a matter of law. In addition, nothing in this Release prevents me from filing, cooperating with, or participating in any proceeding before the Equal Employment Opportunity Commission, the Department of Labor, the California Department of Fair Employment and Housing, or any other local, state, or federal administrative body or government agency that is authorized to enforce or administer laws related to employment, against the Company, except that I hereby waive my right to any monetary benefits in connection with any such claim, charge or proceeding. I hereby represent

and warrant that, other than the Excluded Claims, I am not aware of any claims I have or might have against any of the Released Parties that are not included in the Released Claims.

I acknowledge that I am knowingly and voluntarily waiving and releasing any rights I may have under the ADEA. I also acknowledge that the consideration given for the Released Claims is in addition to anything of value to which I was already entitled. I further acknowledge that I have been advised by this writing, as required by the ADEA, that: (a) the Released Claims do not apply to any rights or claims that arise after the date I sign this Release; (b) I should consult with an attorney prior to signing this Release (although I may choose voluntarily not to do so); (c) I have twenty-one (21) days to consider this Release (although I may choose to voluntarily sign it sooner); (d) I have seven (7) days following the date I sign this Release to revoke the Release by providing written notice to an officer of the Company; and (e) the Release will not be effective until the date upon which the revocation period has expired unexercised, which will be the eighth day after I sign this Release ("**Effective Date**").

I acknowledge that I have read and understand Section 1542 of the California Civil Code which reads as follows: "**A general release does not extend to claims which the creditor does not know or suspect to exist in his or her favor at the time of executing the release, which if known by him or her must have materially affected his or her settlement with the debtor.**" I hereby expressly waive and relinquish all rights and benefits under that section and any law of any jurisdiction of similar effect with respect to my release of any claims hereunder.

I hereby represent that I have been paid all compensation owed and for all hours worked, I have received all the leave and leave benefits and protections for which I am eligible, and I have not suffered any on-the-job injury for which I have not already filed a workers' compensation claim.

I hereby agree not to disparage the Company, or its officers, directors, Executives, shareholders or agents, in any manner likely to be harmful to its or their business, business reputation, or personal reputation; *provided, however*, that I will respond accurately and fully to any question, inquiry or request for information when required by legal process.

I acknowledge that to become effective, I must sign and return this Release to the Company so that it is received not later than twenty-one (21) days following the date it is provided to me, and I must not revoke it thereafter.

RAGHUVeer R. BELUR

Name: _____

Date: _____



15 November 2007

Gregory S. Steele
6018 Melita Glen Place
Santa Rosa, CA 95409

Dear Greg:

Enphase Energy, Inc. (the "**Company**") is pleased to offer you employment on the following terms:

- 1. Position.** Your title will be Vice President of Operations, and you will report to the Chief Executive Officer. This is a full-time position. While you render services to the Company, you will not engage in any other employment, consulting or other business activity (whether full-time or part-time) that would create a conflict of interest with your duties to the Company. By signing this letter agreement, you confirm to that Company that you have no contractual commitments or other legal obligations that would prohibit you from performing your duties for the Company.
- 2. Cash Compensation.** Your compensation plan is defined in Exhibit B. Your salary will be subject to adjustment pursuant to the Company's employee compensation policies in effect from time to time.
- 3. Employee Benefits.** As a regular employee of the Company, you will be eligible to participate in regular health insurance, profit sharing, bonus, and other employee benefit plans if and as established by the Company for its employees from time to time. In addition to your gross salary, the Company will make an annual contribution on your behalf to the Company's 401(k) Plan of three percent (3%) of your "compensation", as set forth in the Company's 401(k) plan, for the preceding 12-month period, subject to the provisions of the Company's 401 (k) Plan. The Company may change or cease to make these contributions at any time for any reason, with or without notice, provided, however, to the extent the Company reduces its contributions from this three percent (3%) level, your salary will be increased by an equivalent amount. In addition, you will be entitled to paid vacation in accordance with the Company's vacation policy, as in effect from time to time.

4. **Expenses.** You will be reimbursed for reasonable legitimate business expenses incurred in the performance of your duties in accordance with the Company's expense reimbursement policies, as in effect from time to time.

5. **Stock Grant.** Following execution of this letter agreement, we will recommend to the Board of Directors of the Company that you be granted the opportunity to purchase up to One Hundred and Thirty Five Thousand, Seven Hundred and Fifty Five (135,755) shares of Common Stock of the Company under the Company's 2006 Equity Incentive plan (the "**Plan**"). The price per share will be equal to the fair market value per share on the date the Board approves such grant or on your first day of employment, whichever is later. The shares will be subject to the terms and conditions applicable to shares granted under the Plan, as described in and subject to the plan and the applicable stock option or purchase agreement. Subject to your continued employment and the terms and conditions of the plan and applicable agreement twenty-five percent (25%) of the shares will vest twelve(12) months following your first date of employment, and the balance will vest in equal monthly installments over the next thirty-six (36) months of continuous service, as described in the applicable stock purchase agreement.

With respect to the foregoing, the grant of the opportunity to purchase such shares by the Company is subject to the Board's approval and this promise to recommended such approval is not a promise of compensation and is not intended to create any obligation on the part of the Company.

6. **Confidentiality.** As an employee of the Company, you will have access to certain confidential information of the Company and you may, during the course of your employment, develop certain information or inventions that will be the property of the Company. To protect the interests of the Company, you will need to sign the company's standard "Employee Invention Assignment and Confidentiality Agreement" attached hereto as Exhibit A as a condition of your employment. We wish to impress upon you that we do not want you to, and we hereby direct you not to, bring with you any confidential or proprietary material of any former employer or to violate any other obligations you may have to any former employer. During the period that you render services to the Company, you agree to not engage in any employment, business or activity that is in any way competitive with the business or proposed business of the Company. You will disclose to the Company in writing any other gainful employment, business or activity that you are currently associated with or participate in that

competes with the Company. You will not assist any other person or organization in competing with the Company or in preparing to engage in competition with the business or proposed business of the Company. You represent that your signing of this offer letter, agreement(s) concerning stock granted to you, if any, under the Plan and the Company's Employee Invention Assignment and Confidentiality Agreement and your commencement of employment with the Company will not violate any agreement currently in place between yourself and current or past employers.

7. Employment Relationship. Employment with the Company is for no specific period of time. Your employment with the Company will be "at will," meaning that either you or the Company may terminate your employment at any time and for any reason, with or without cause. Any contrary representations that may have been made to you are superseded by this letter Agreement. This is the full and complete agreement between you and the Company on this term. Although your job duties, title, compensation and benefits, as well as the Company's personnel policies and procedures, any change from time to time, the "at will" nature of your employment may only be changed in an express written agreement signed by you and duly authorized officer of the Company (other than you).

8. Withholding Taxes. All forms of compensation referred to in this letter agreement are subject to reduction to reflect applicable withholding and payroll taxes and other deductions required by law.

9. Interpretation, Amendment and Enforcement. This letter agreement and Exhibit A constitute the complete agreement between you and the Company, contain all of the terms of your employment with the Company and supersede any prior agreements, representations or understandings (whether written, oral or implied) between you and the Company. This letter agreement may not be amended or modified, except by an express written agreement signed by both you and a duly authorized officer of the Company. The terms of this letter agreement and the resolution of any disputes as to the meaning, effect, performance or validity of this letter agreement or arising out of, related to, or in any way connected with, this letter agreement, your employment with the Company or any other relationship between you and the Company (the "**Disputes**") will be governed by California law, excluding laws relating to conflicts or choice of law. You and the Company submit to the exclusive personal jurisdiction of the federal and state courts located in San Francisco and

Sonoma County in connection with any Dispute or any Claim related to any Dispute.

* * * * *

We hope that you will accept our offer to join the Company on the terms of this letter. You may indicate your agreement with these terms and accept this offer by signing and dating both the enclosed duplicate original of this letter agreement and the enclosed Proprietary Information and Inventions Agreement and returning them to me. This offer, if not accepted, will expire at the close of business on 15 November 2007. As required by law, your employment with the Company is contingent upon your providing legal proof of your identity and authorization to work in the United States. Your employment is also contingent upon your starting work with the Company on or before 28 January 2008.

Very truly yours,

ENPHASE ENERGY, INC.

By: /s/ Paul B Nahi
Paul B Nahi

Title: President and CEO

I have read and accept this employment offer:

/s/ Gregory S. Steele

Signature of Gregory S. Steele

Dated: 11/15/07

Attachment

Exhibit A: Employee Invention Assignment and Confidentiality Agreement

Exhibit B: Compensation Plan

EXHIBIT A

Employee Invention Assignment and Confidentiality Agreement

In consideration of, and as a condition of my employment with Enphase Energy, Inc., a Delaware corporation (the “*Company*”), I hereby represent to, and agree with the Company as follows:

Purpose of Agreement. I understand that the Company is engaged in a continuous program of research, development, production and marketing in connection with its business and that it is critical for the Company to preserve and protect its “*Proprietary Information*” (as defined in Section 7 below), its rights in “*Inventions*” (as defined in Section 2 below) and in all related intellectual property rights. Accordingly, I am entering into this Employee Invention Assignment and Confidentiality Agreement (this “*Agreement*”) as a condition of my employment with the Company, whether or not I am expected to create inventions of value for the Company.

Disclosure of Inventions. I will promptly disclose in confidence to the Company all inventions, improvements, designs, original works of authorship, formulas, processes, compositions of matter, computer software programs, databases, mask works, designs and trade secrets that I make or conceive or first reduce to practice or create, either alone or jointly with others, during the period of my employment, whether or not in the course of my employment, and whether or not patentable, copyrightable or protectable as trade secrets (the “*Inventions*”).

Work for Hire; Assignment of Inventions. I acknowledge and agree that any copyrightable works prepared by me within the scope of my employment are “works for hire” under the Copyright Act and that the Company will be considered the author and owner of such copyrightable works. I agree that all Inventions that (i) are developed using equipment, supplies, facilities or trade secrets of the Company, (ii) result from work performed by me for the Company, or (iii) relate to the Company’s business or current or anticipated research and development (the “*Assigned Inventions*”), will be the sole and exclusive property of the Company and are hereby irrevocably assigned by me to the Company.

Labor Code Section 2870 Notice. I have been notified and understand that the provisions of Sections 3 and 5 of this Agreement do not apply to any

Assigned Invention that qualifies fully under the provisions of Section 2870 of the California Labor Code, which states as follows:

ANY PROVISION IN AN EMPLOYMENT AGREEMENT WHICH PROVIDES THAT AN EMPLOYEE SHALL ASSIGN, OR OFFER TO ASSIGN, ANY OF HIS OR HER RIGHTS IN AN INVENTION TO HIS OR HER EMPLOYER SHALL NOT APPLY TO AN INVENTION THAT THE EMPLOYEE DEVELOPED ENTIRELY ON HIS OR HER OWN TIME WITHOUT USING THE EMPLOYER'S EQUIPMENT, SUPPLIES, FACILITIES, OR TRADE SECRET INFORMATION EXCEPT FOR THOSE INVENTIONS THAT EITHER: (1) RELEASE AT THE TIME OF CONCEPTION OR REDUCTION TO PRACTICE OF THE INVENTION TO THE EMPLOYER'S BUSINESS, OR ACTUAL OR DEMONSTRABLY ANTICIPATED RESEARCH OR DEVELOPMENT OF THE EMPLOYER; OR (2) RESULT FROM ANY WORK PERFORMED BY THE EMPLOYEE FOR THE EMPLOYER. TO THE EXTENT A PROVISION IN AN EMPLOYMENT AGREEMENT PURPORTS TO REQUIRE AN EMPLOYEE TO ASSIGN AN INVENTION OTHERWISE EXCLUDED FROM BEING REQUIRED TO BE ASSIGNED UNDER CALIFORNIA LABOR CODE SECTION 2870(a), THE PROVISION IS AGAINST THE PUBLIC POLICY OF THIS STATE AND IS UNENFORCEABLE.

Assignment of Other Rights. In addition to the foregoing assignment of Assigned Inventions to the Company, I hereby irrevocably transfer and assign to the Company: (i) all worldwide patents, patent applications, copyrights, mask works, trade secrets and other intellectual property rights, including but not limited to rights in databases, in any Assigned Inventions, along with any registrations of or applications to register such rights; and (ii) any and all "Moral

Rights” (as defined below) that I may have in or with respects to any Assigned Inventions. I also hereby forever waive and agree never to assert any and all Moral Rights I may have in or with respect to any Assigned Inventions, even after termination of my work on behalf of the Company. “**Moral Rights**” mean any rights to claim authorship of or credit on an Assigned Inventions, to object to or prevent the modification or destruction of any Assigned Inventions, or to withdraw from circulation or control the publication or distribution of any Assigned Inventions, and any similar right, existing under judicial or statutory law of any country or subdivision thereof in the world, or under any treaty, regardless of whether or not such right is denominated or generally referred to as a “moral right.”

Assistance. I agree to assist the Company in every proper way to obtain for the Company and enforce patents, copyrights, mask work rights, trade secret rights and other legal protections for the Company’s Assigned Inventions in any and all countries. I will execute any documents that the Company may reasonably request for use in obtaining or enforcing such patents, copyrights, mask work rights, trade secrets and other legal protections. My obligations under this paragraph will continue beyond the termination of my employment with the Company, provided that the Company will compensate me at a reasonable rate after such termination for time or expenses actually spent by me at the Company’s request on such assistance. I appoint the Secretary of the Company as my attorney-in-fact to execute documents on my behalf for this purpose.

Proprietary Information. I understand that my employment by the Company creates a relationship of confidence and trust with respect to any information of a confidential or secret nature that may be disclosed to me by the Company or a third party that relates to the business of the Company or to the business of any parent, subsidiary, affiliate, customer or supplier of the Company or any other party with whom the Company agrees to hold information of such party in confidence (the “**Proprietary Information**”). Such Proprietary Information includes, but is not limited to, Assigned Inventions, marketing plans, product plans, business strategies, financial information, forecasts, personnel information customer lists and data, and domain names.

Confidentiality. At all times, both during my employment and after its termination, I will keep and hold all such Proprietary Information in strict confidence trust. I will not use or disclose any Proprietary Information without the prior written consent of the Company, except as may be necessary to

perform my duties as an employee of the Company for the benefit of the Company. Upon termination of my employment with the Company, I will promptly deliver to the Company all documents and materials of any nature pertaining to my work with the Company and, upon Company request will execute a document confirming my agreement to honor my responsibilities contained in this Agreement. I will not take with me or retain any documents or materials or copies thereof containing any Proprietary Information.

No Breach of Prior Agreement. I represent that my performance of all the terms of this Agreement and my duties as an employee of the Company will not breach any invention assignment, proprietary information, confidentiality or similar agreement with any former employer or other party. I represent that I will not bring with me to the Company or use in the performance of my duties for the Company any documents or materials or intangibles of a former employer or third party that are not generally available to the public or have not been legally transferred to the Company.

Efforts; Duty Not to Compete. I understand that my employment with the Company requires my undivided attention and effort during normal business hours. While I am employed by the Company, I will not, without the Company's express prior written consent, provide services to, or assist in any manner, any business or third party if such services or assistance would be in direct conflict with the Company's business interests.

Notification. I hereby authorize the Company to notify third parties, including, without limitation, customers and actual or potential employers, of the terms of this Agreement and my responsibilities hereunder.

Non-Solicitation of Employees/Consultants. During my employment with the Company and for a period of one (1) year thereafter, I will not directly or indirectly solicit away employees or consultants of the Company for my own benefit of any other person or entity.

Non-Solicitation of Suppliers/Customers. During my employment with the Company and after termination of my employment, I will not directly or indirectly solicit or take away suppliers or customers of the Company if the identity of the supplier or customer or information about the supplier or customer relationship is a trade secret or is otherwise deemed confidential information within the meaning of California law.

Name and Likeness Rights. I hereby authorize the Company to use, reuse, and to grant others the right to use and reuse, my name, photograph, likeness (including caricature), voice, and biographical information, and any reproduction or simulation thereof, in any form of media or technology now known or hereafter developed (including, but not limited to, film, video and digital or other electronic media), both during and, after my employment, for any purposes related to the Company's business, such as marketing, advertising, credits, and presentations.

Injunctive Relief. I understand that in the event of a breach or threatened breach of this Agreement by me the Company may suffer irreparable harm and will therefore be entitled to injunctive relief to enforce this Agreement.

Governing Law; Severability. This Agreement will be governed by and construed in accordance with the laws of the State of California, without giving effect to its laws pertaining to conflict of laws. If any provision of this Agreement is determined by any court of arbitrator of competent jurisdiction to be invalid, illegal or unenforceable in any respect, such provision will be enforced to the maximum extent possible given the intent of the parties hereto. If such clause of provision cannot be so enforced, such provision shall be stricken from this Agreement and the remainder of this Agreement shall be enforced as if such invalid, illegal or unenforceable clause of provision had (to the extent not enforceable) never been contained in this Agreement.

Counterparts. This Agreement may be executed in any number of counterparts, each of which when so executed and delivered will be deemed an original, and all of which together shall constitute one and the same agreement.

Entire Agreement. This Agreement and the documents referred to herein constitute the entire agreement and understanding of the parties with respect to the subject matter of this Agreement, and supersede all prior understandings and agreements, whether oral or written, between or among the parties hereto with respect to the specific subject matter hereof.

Amendment and Waivers. This Agreement may be amended only by a written agreement executed by each of the parties hereto. No amendment or waiver of, or modification of any obligation under this Agreement will be enforceable unless set forth in a writing signed by the party against which enforcement is sought. Any amendment effected in accordance with this section

will be binding upon all parties hereto and each of their respective successors and assigns. No delay or failure to require performance of any provision of this Agreement shall constitute a waiver of that provision as to that or any other instance. No waiver granted under this Agreement as to any one provision herein shall constitute a subsequent waiver of such provision of any other provision herein, nor shall it constitute the waiver of any performance other than the actual performance specifically waived.

Successors and Assigns; Assignment. Except as otherwise provided in this Agreement, this Agreement, and the rights and obligations of the parties hereunder, will be binding upon and inure to the benefit of their respective successors, assigns, heirs, executors, administrators and legal representatives. The Company may assign any of its rights and obligations under this Agreement. No other party to this Agreement may assign, whether voluntarily or by operation of law, any of its rights and obligations under this Agreement, except with the prior written consent of the Company.

Further Assurances. The parties agree to execute such further documents and instruments and to take such further actions as may be reasonably necessary to carry out the purposes and intent of this Agreement.

“At Will” Employment. I understand that this Agreement does not constitute a contract of employment or obligate the Company to employ me for any stated period of time. I understand that I am an “at will” employee of the Company and that my employment can be terminated at any time, with or without notice and with or without cause, for any reason or for no reason, by either the Company or myself. I acknowledge that any statements of representations to the contrary are ineffective, unless put into a writing signed by the Company. I further acknowledge that my participation in any stock option or benefit program is not to be construed as any assurance of continuing employment of any particular period of time. This Agreement shall be effective as of the first day of my employment by the Company, which is 28 January 2008.

* * * * *

EXHIBIT B

Compensation Plan

Your total compensation will consist of a Base Salary and a Bonus Plan.

Base salary: The Company will pay you a starting base salary at the rate of One Hundred and Thirty Six Thousand Dollars (\$136,000) per year, payable in accordance with the Company's standard payroll schedule.

Bonus Plan: Your 2007 Bonus Plan will consist of up to Fifteen Thousand Dollars (\$15,000), payable semi-annually (once every six months), with respect to portions of such Bonus Plan achieved, if any, during the preceding six months. The Bonus Plan is subject to your achieving the following goals to the satisfaction of the Chief Executive Officer:

- 1) **Cost reduction:** Continuous and significant cost reductions through vendor or negotiations, strategic component selection, manufacturing efficiencies, judicious use of oversees manufacturing and engineering guidance.
- 2) **Product quality:** Ensuring that each and every unit is fully tested and qualified for production use. The Company's stated goal for 2008 is to have no defects and no returns. This will include development of the manufacturing test programs, establishing a quality verification process at the contract manufacturer's interfacing with engineering to ensure DFM and DFT compliance, failure analysis and any other tool or procedure to necessary to guarantee quality.
- 3) **Just in time delivery:** Ensuring that delivery schedules are understood and met. Includes development of the scheduling process as well as its consistent implementation.
- 4) **Establishment of all relevant process and procedures:** Create and utilize all necessary processes and procedure required to accomplish all the above goals and ensure a well functioning organization.

In Witness Whereof, the parties have executed this Agreement as of the 15 November 2007.

Enphase Energy, Inc.:

Employee:

By: /s/ Paul B Nahi
Signature
Name: Paul B Nahi
Title: President and CEO

 /s/ Gregory S. Steele
Signature
Gregory S. Steele

Signature Page to Employee Invention Assignment and Confidentiality Agreement



August 23, 2010

Bill Rossi
Palo Alto, California

Dear Bill:

Enphase Energy, Inc. (the "**Company**") is pleased to offer you employment on the following terms:

1. Position. Your title will be Chief Marketing Officer and you will report to Paul Nahi, President and CEO. This is a full-time position. While you render services to the Company, you will not engage in any other employment, consulting or other business activity (whether full-time or part time) that would create a conflict of interest with your duties to the Company. By signing this letter agreement, you confirm to the Company that you have no contractual commitments or other legal obligations that would prohibit you from performing your duties for the Company.

In connection with your joining the Company, our mutual understanding and agreement is that you will relocate to Northern California by September 2011.

2. Cash Compensation. The Company will pay you a starting salary at the rate of Two Hundred Twenty-Five Thousand Dollars (\$225,000) per year, payable in accordance with the Company's standard payroll schedule. Your salary will be subject to adjustment pursuant to the Company's employee compensation policies in effect from time to time. In addition, during your first twelve months of employment, and subject to your continued employment with the Company, you will be eligible to receive a cash bonus of up to Forty Thousand Dollars (\$40,000) (the "**First Year Bonus**"), based upon completion of objectives to be mutually agreed upon by you and the Company's Chief Executive Officer (the "**First Year MBO's**"). Bonuses in future periods, subject to your continued employment with the Company, are to be mutually agreed upon by you and the Company's Chief Executive Officer. Bonus payment(s) will be paid to you within 60 days following the date that the Company determines that the applicable bonus has been earned, if any. You must be an employee in good standing on the date that an incentive compensation payment is to be paid in order to earn such payment.

3. **Relocation Expenses.** You will be eligible for reimbursement of up to Twenty Thousand Dollars (\$20,000) in qualified relocation expenses for your move to Northern California in accordance with the Company's expense reimbursement policies provided that you complete your relocation by September 2011 and that you are an employee in good standing on the date on which you submit the qualified expenses for reimbursement. You will be responsible for all state and federal income and employment taxes associated with these expense payments.

4. **Employee Benefits.** As a regular employee of the Company, you will be eligible to participate in regular health insurance, profit sharing, bonus, and other employee benefit plans if and as established by the Company for its employees from time to time. In addition to your gross salary, the Company will make an annual contribution on your behalf to the Company's 401(k) Plan of three percent (3%) of your "compensation", as set forth in the Company's 401(k) Plan, for the preceding 12-month period, subject to the provisions of the Company's 401(k) Plan. The Company may change or cease to make these contributions in future calendar years by providing notice in advance of the beginning of the next plan year. In addition, you will be entitled to paid vacation in accordance with the Company's vacation policy, as in effect from time to time.

5. **Expense.** You will be reimbursed for reasonable legitimate business expenses incurred in the performance of your duties in accordance with the Company's expense reimbursement policies, as in effect from time to time.

6. **Stock Option Grant.** Following execution of this letter agreement, we will recommend to the Board of Directors of the Company that you be granted a stock option (the "**Option**") to purchase up to Two Million, Two Hundred Seventeen Thousand, One Hundred Eighty-Three (2,217,183) shares of Common Stock of the Company under the Company's 2006 Equity Incentive Plan (the "**Plan**"). The exercise price per share will be equal to the fair market value per share on the date the Board approves such Option grant or on your first day of employment, whichever is later. The Option will be subject to the terms and conditions applicable to options granted under the Plan, as described in and subject to the Plan and the applicable stock option agreement. Subject to your continued employment and the terms and conditions of the Plan and applicable agreement and except as otherwise described in Section 7 below, twenty-five percent (25%) of the Option shares will vest and become exercisable twelve (12) months following your first day of employment, and the balance will vest and

become exercisable in equal monthly installments over the next thirty-six (36) months of continuous service, as described in the applicable stock option agreement.

With respect to the foregoing, the grant of the opportunity to purchase such shares by the Company is subject to the Board's approval and this premise to recommend such approval is not a promise of compensation and is not intended to create any obligation on the part of the Company.

7. Stock Option Vesting Acceleration Upon Termination of Employment Following a Change of Control. In the event of a Change of Control and, following such Change of Control, your employment is terminated by the Company or the surviving entity as a result of an involuntary termination other than for Cause at any time within 24 months of your first day of employment with the Company, then the Option referenced in Section 6 shall become immediately vested as to 50% of the total number of Option shares (including shares previously vested). No benefits under this Section 7 will apply after 24 months of your first day of employment with the Company, and the foregoing option vesting arrangement will only apply to the Option (your initial option grant referenced in Section 6), unless otherwise approved by the Board.

8. Parachute Payments. In the event that the acceleration and severance benefits provided for in this letter agreement and otherwise (A) constitute "parachute payments" within the meaning of Section 280G of the Internal Revenue Code of 1986, as amended (the "Code") and (B) but for this paragraph, would be subject to the excise tax imposed by Section 4999 of the Code, then your benefits hereunder shall be payable either: (X) in full, or (Y) as to such lesser amount which would result in no portion of such severance benefits being subject to excise tax under Section 4999 of the Code, whichever of the foregoing amounts, taking into account the applicable federal, state and local income taxes and the excise tax imposed by Section 4999, results in the receipt by you on an after-tax basis, of the greatest amount of benefits hereunder, notwithstanding that all or some portion of such benefits may be taxable under Section 4999 of the Code. Unless the Company and you otherwise agree in writing, any determination required under this paragraph shall be made in writing by the public accountants designated by the Company (the "Accountants"), whose determination shall be conclusive and binding upon you and the Company for all purposes. For purposes of making the calculations required by this paragraph, the Accountants may make reasonable assumptions and approximations concerning

applicable taxes and may rely on reasonable, good faith interpretations concerning the application of Section 280G and 4999 of the Code. The Company and you shall furnish to the Accountants such information and documents as the Accountants may reasonably request in order to make a determination under this paragraph. The Company shall bear all costs the Accountants may reasonably incur in connection with any calculations contemplated by this paragraph. In the event that a reduction in payments and/or benefits is required under this paragraph, such reduction shall occur in the following order: (1) reduction of cash payments; (2) reduction of acceleration of vesting of options and shares; and (3) reduction of other benefits paid to you. If the acceleration of vesting of options and shares is to be reduced, such acceleration of vesting shall be cancelled in the reverse order of the highest price option grant or highest purchase price per share down to the lowest priced option grant or lowest purchase price per share.

9. Employment Relationship. Employment with the Company is for no specific period of time. Your employment with the Company will be “at will,” meaning that either you or the Company may terminate your employment at any time and for any reason, with or without cause. Any contrary representations that may have been made to you are superseded by this letter agreement. This is the full and complete agreement between you and the Company on this term. Although your job duties, title, compensation and benefits, as well as the Company’s personnel policies and procedures, may change from time to time, the “at will” nature of your employment may only be changed in an express written agreement signed by you and a duly authorized officer of the Company (other than you).

Notwithstanding the foregoing, if your employment is terminated by the Company as a result of an involuntary termination other than for Cause at any time within 12 months of your first day of employment with the Company, then, subject to the terms set forth in this letter agreement, you will be entitled to receive severance benefits as follows: (i) severance payments for a period of three (3) months following the date of your termination (the “**Severance Period**”) equal to your then current base salary, which payments shall be paid during the severance Period in accordance with the Company’s standard payroll practices, and (ii) continuation of the health insurance benefits provided to you for you and your eligible dependents at Company expense pursuant to the terms of the Consolidated Omnibus Budget Reconciliation Act of 1985, as amended (“**COBRA**”) or other applicable law through the earlier of the end of the Severance Period or the date upon which you are no longer eligible for such

COBRA or other benefits under applicable law. For the avoidance of doubt, no benefits under this paragraph will apply after 12 months of your first day of employment with the Company.

10. Limitations and Conditions on Benefits.

(a) **Income and Employment Taxes.** You agree that you shall be responsible for any applicable taxes of any nature (including any penalties or interest that may apply to such taxes) that the Company reasonably determines apply to any payment made under this letter agreement, that your receipt of any benefit hereunder is conditioned on your satisfaction of any applicable withholding or similar obligations that apply to such benefit, and that any cash payment owed hereunder will be reduced to satisfy any such withholding or similar obligations that may apply.

(b) **Code Section 409A.** All payments to be made upon a termination of employment under this Agreement may be made only upon a “separation from service” within the meaning of Section 409A of the Internal Revenue Code of 1986, as amended (the “Code”), and the Department of Treasury regulations and other guidance promulgated thereunder (a “**Separation from Service**”). Notwithstanding any provision of this Agreement to the contrary, if, at the time of your termination of employment with the Company, you are a “specified employee” (as defined in Section 409A of the Code) and the deferral of the commencement of any severance payments or benefits otherwise payable pursuant to this letter agreement as a result of such termination of employment is necessary in order to prevent any accelerated or additional tax under Section 409A of the Code, then the Company will defer the commencement of the payment of any such severance payments or benefits hereunder (without any reduction in such payments or benefits ultimately paid or provided to you) that will not and could not under any circumstances, regardless of when such termination occurs, be paid in full by March 15 of the year following your termination and are in excess of the lesser of (i) two (2) times your then annual compensation or (ii) two (2) times the limit on compensation then set forth in Section 401(a)(17) of the Code and will not be paid by the end of the second calendar year following the year in which the termination occurs, until the first payroll date that occurs after the date that is six (6) months following your Separation from Service with the Company (as defined under Code Section 409A). If any payments are deferred due to such requirements, such amounts will be paid in a lump sum to you on the earliest of (a) your death following the date

of your termination of employment with the Company or (ii) the first payroll date that occurs after the date that is six (6) months following your Separation from Service with the Company. For these purposes, each severance payment or benefit is hereby designated as a separate payment or benefit and will not collectively be treated as a single payment or benefit. This paragraph is intended to comply with the requirements of Section 409A of the Code so that none of the severance payments and benefits to be provided hereunder will be subject to the additional tax imposed under Section 409A of the Code and any ambiguities herein will be interpreted to so comply. You and the Company agree to work together in good faith to consider amendments to this Agreement and to take such reasonable actions which are necessary, appropriate or desirable to avoid imposition of any additional tax or income recognition prior to actual payment to you under Section 409A of the Code.

To the extent that any reimbursements or expense payments payable to you are subject to the provisions of Section 409A of the Code, any such reimbursements or payments shall be paid no later than December 31 of the year following the year in which, the expense was incurred, the amount of expenses reimbursed in one year shall not affect the amount eligible for reimbursement in any subsequent year, and the right to reimbursement will not be subject to liquidation or exchange for another benefit.

(c) **Release Prior to Receipt of Benefits.** As a condition of receiving the termination benefits under this letter agreement, you shall execute, and allow to become effective, a release of claims agreement (the "Release") not later than fifty (50) days following your Separation from Service in the form provided by the Company. Such Release shall specifically relate to all of your rights and claims in existence at the time of such execution and shall confirm your obligations under the Company's standard Employee Invention Assignment and Confidentiality Agreement. Unless the Release is timely executed by you, delivered to the Company, and becomes effective within the required period (the date on which the Release becomes effective, the "Release Date"), you will not receive any of the benefits provided for under this letter agreement. In no event will benefits be provided to you until the Release becomes effective. Any lump sum payment owed to you shall be paid within ten (10) business days following the Release Date, but in no event later than March 15 of the year following the year in which the applicable event occurs.

11. **Confidentiality.** As an employee of the Company, you will have access to certain confidential information of the Company and you may, during the course of your employment, develop certain information or inventions that will be the property of the Company. To protect the interests of the company, you will need to sign the Company's standard "Employee Invention Assignment and Confidentiality Agreement" attached hereto as Exhibit A as a condition of your employment. We wish to impress upon you that we do not want you to, and we hereby direct you not to, bring with you any confidential or proprietary material of any former employer or to violate any other obligations you may have to any former employer. During the period that you render services to the Company, you agree to not engage in any employment, business or activity that in any way competitive with the business or proposed business of the company. You will disclose to the Company in writing any other gainful employment, business or activity that you are currently associated with or participate in that competes with the Company. You will not assist any other person or organization in competing with the Company or in preparing to engage in competition with the business or proposed business of the Company. You represent that your signing of this offer letter, agreement(s) concerning stock options granted to you, if any, under the Plan and the Company's Employee Invention Assignment and Confidentiality Agreement and your commencement of employment with the Company will not violate any agreement currently in place between yourself and current or past employers.

12. **Definition of Terms.** The following terms referred to in this letter agreement shall have the following meanings:

(a) **Change of Control.** "Change of Control" shall mean a sale of all substantially all of the Company's assets, or any merger or consolidation of company with or into another corporation other than a merger or consolidation in which the holders of more than 50% of the shares of capital stock of the Company outstanding immediately prior to such transaction continue to hold (either by voting securities remaining outstanding or by their being converted into voting securities of the surviving entity) more than 50% of the total voting power represented by the voting securities of the Company, or such surviving entity, outstanding immediately after such transaction. For purposes of clarification, neither an equity financing occurring prior to an IPO nor an IPO will be a Change of Control, even if equity securities representing greater than 50% of the total voting power of the Company are sold in the transaction.

(b) **Cause.** “Cause” shall mean, as determined by the Board of Directors of the Company acting in good faith and based on information then known to it: (A) gross negligence or willful misconduct in the performance of duties to the Company where such gross negligence or willful misconduct has resulted or is likely to result in substantial and material damage to the Company or its subsidiaries; (B) a material failure to comply with the Company’s written policies after having received from the Company notice of, and a reasonable time to cure, such failure; (C) repeated unexplained or unjustified absence from the Company; (D) conviction of a felony or a crime involving moral turpitude causing material harm to the standing and reputation of the company; (E) unauthorized use or disclosure of any proprietary information or trade secrets of the Company or any other party to whom you owe an obligation of non-disclosure as a result of your relationship with the Company, which use or disclosure causes or is likely to cause material harm to the Company; or (F) your death or Permanent Disability.

(c) **Permanent Disability.** “Permanent Disability” shall mean your inability to engage in any substantial gainful activity by reason of any medically determinable physical or mental impairment which can be expected to result in death or which has lasted or can be expected to last for a continuous period of not less than six (6) months.

13. **Interpretation, Amendment and Enforcement.** This letter agreement and Exhibit A constitute the complete agreement between you and the Company, contain all of the terms of your employment with the Company and supersede any prior agreements, representations or understandings (whether written, oral or implied) between you and the Company. This letter agreement may not be amended or modified, except by an express written agreement signed by both you and a duly authorized officer of the Company. The terms of this letter agreement and the resolution of any disputes as to the meaning, effect, performance or validity of this letter agreement or arising out of, related to, or in any way connected with, this letter agreement, your employment with the Company or any other relationship between you and the Company (the “*Disputes*”) will be governed by California law, excluding laws relating to conflicts or choice of law. You and the Company submit to the exclusive personal jurisdiction of the federal and state courts located in San Francisco and Sonoma County in connection with any Dispute or any claim related to any Dispute.

* * * * *

We hope that you will accept our offer to join the Company on the terms of this letter agreement. You may indicate your agreement with these terms and accept this offer by signing and dating both the enclosed duplicate original of this letter agreement and the enclosed Proprietary Information and Inventions Agreement and returning them to me. This offer, if not accepted, will expire at the close of business on August 27, 2010. As required by law, your employment with the Company is contingent upon your providing legal proof of your identity and authorization to work in the United States. Your employment is also contingent upon your starting work with the Company on or before September 1, 2010.

Very truly yours,

ENPHASE ENERGY, INC.

By: /s/ Paul Nahi
Paul Nahi

Title: President and CEO

I have read and accept this employment offer:

 /s/ Bill Rossi

Signature of Bill Rossi

Dated: 9/1/10

Attachment

Exhibit A: Employee Invention Assignment and Confidentiality Agreement

EXHIBIT A

EMPLOYEE INVENTION ASSIGNMENT AND CONFIDENTIALITY AGREEMENT

In consideration of, and as a condition of my employment with Emphase Energy, Inc., a Delaware corporation (the “*Company*”), I hereby represent to, and agree with the Company as follows:

Purpose of Agreement. I understand that the Company is engaged in a continuous program of research, development, production and marketing in connection with its business and that it is critical for the Company to preserve and protect its Proprietary Information (as defined in Section 7 below), its rights in Inventions (as defined in Section 2 below) and in all related intellectual property rights. Accordingly, I am entering into this Employee Invention Assignment and Confidentiality Agreement (this “*Agreement*”) as a condition of my employment with the Company, whether or not I am expected to create inventions of value for the Company.

Disclosure of Inventions. I will promptly disclose in confidence to the Company all inventions, improvements, designs, original works of authorship, formulas, processes, compositions of matter, computer software programs, databases, mask ;works, designs and trade secrets that I make or conceive or first reduce to practice or create, either alone or jointly with others, during the period of my employment, whether or not in the course of my employment, and whether or not patentable, copyrightable or protectable as trade secrets (the “*Inventions*”).

Inventions Retained and Licensed. I have attached hereto, as Exhibit A, a list describing with particularity all inventions, original works of authorship, developments, improvements, and trade secrets which were made by me prior to the commencement of my employment with the Company (collectively referred to as “*Prior Inventions*”), which belong solely to me or belong to me jointly with another, which relate in any way to any of the Company’s proposed businesses, products or research and development, and which are not assigned to the Company hereunder; or, if no such list is attached, I represent that there are no such prior Inventions. If, in the course of my employment with the Company, I incorporate into a Company product, process or machine a Prior Invention owned by me or in which I have an interest, the Company is hereby granted and shall have a non-exclusive, royalty-free, irrevocable, perpetual, worldwide license (with the right to sublicense) to make, have made, copy, modify, make derivative

works of, use, sell and otherwise distribute such Prior Invention as part of or in connection with such product, process or machine.

Work for Hire: Assignment of Inventions. I acknowledge and agree that any copyrightable works prepared by me within the scope of my employment are “works for hire” under the Copyright Act and that the Company will be considered the author and owner of such copyrightable works. I agree that all Inventions that (i) are developed using equipment, supplies, facilities or trade secrets of the Company, (ii) result from work performed by me for the Company, or (iii) relate to the Company’s business or current or anticipated research and development (the “**Assigned Inventions**”), will be the sole and exclusive property of the Company and are hereby irrevocably assigned by me to the Company.

Labor Code Section 2870 Notice. I have been notified and understand that the provisions of Sections 3 and 5 of this Agreement do not apply to any Assigned Invention that qualifies fully under the provisions of Section 2870 of the California Labor Code, which states as follows:

ANY PROVISION IN AN EMPLOYMENT AGREEMENT WHICH PROVIDES THAT AN EMPLOYEE SHALL ASSIGN, OR OFFER TO ASSIGN, ANY OF HIS OR HER RIGHTS IN AN INVENTION TO HIS OR HER EMPLOYER SHALL NOT APPLY TO AN INVENTION THAT THE EMPLOYEE DEVELOPED ENTIRELY ON HIS OR HER OWN TIME WITHOUT USING THE EMPLOYER’S EQUIPMENT, SUPPLIES, FACILITIES, OR TRADE SECRET INFORMATION EXCEPT FOR THOSE INVENTIONS THAT EITHER: (1) RELATE AT THE TIME OF CONCEPTION OR REDUCTION TO PRACTICE OF THE INVENTION TO THE EMPLOYER’S BUSINESS, OR ACTUAL OR DEMONSTRABLY ANTICIPATED RESEARCH OR DEVELOPMENT OR THE EMPLOYER; OR (2) RESULT FROM ANY WORK PERFORMED BY THE EMPLOYEE FOR THE EMPLOYER. TO THE EXTENT A PROVISION IN AN

EMPLOYMENT AGREEMENT PURPORTS TO REQUIRE AN EMPLOYEE TO ASSIGN AN INVENTION OTHERWISE EXCLUDED FROM BEING REQUIRED TO BE ASSIGNED UNDER CALIFORNIA LABOR CODE SECTION 2870(a), THE PROVISION IS AGAINST THE PUBLIC POLICY OF THIS STATE AND IS UNENFORCEABLE.

Assignment of Other Rights. In addition to the foregoing assignment of Assigned Inventions to the Company, I hereby irrevocably transfer and assign to the Company: (i) all worldwide patents, patent applications, copyrights, mask works, trade secrets and other intellectual property rights, including but not limited to rights in databases, in any Assigned Inventions, along with any registrations of or applications to register such rights, and (ii) any and all “Moral Rights” (as defined below) that I may have in or with respect to any Assigned Inventions. I also hereby forever waive and agree never to assert any and all Moral Rights I may have in or with respect to any Assigned Inventions, even after termination of my work on behalf of the Company. **“Moral Rights”** mean any rights to claim authorship of or credit on an Assigned Inventions, to object to or prevent the modification or destruction of any Assigned Inventions, or to withdraw from circulation or control the publication or distribution of any Assigned Inventions, and any similar right, existing under judicial or statutory law of any country or subdivision thereof in the world, or under any treaty, regardless of whether or not such right is denominated or generally referred to as a “moral right.”

Assistance. I agree to assist the Company in every proper way to obtain for the Company and enforce patents, copyrights, mask work rights, trade secret rights and other legal protections for the Company’s Assigned Inventions in any and all countries. I will execute any documents that the Company may reasonably request for use in obtaining or enforcing such patents, copyrights, mask work rights, trade secrets and other legal protections. My obligations under this paragraph will continue beyond the termination of my employment with the Company, provided that the Company will compensate me at a reasonable rate after such termination for time or expenses actually spent by me at the Company’s request on such assistance. I appoint the Secretary of the Company as my attorney-in-fact to execute documents on my behalf for this purpose.

Proprietary Information. I understand that my employment by the Company creates a relationship of confidence and trust with respect to any information of a confidential or secret nature that may be disclosed to me by the Company or a third party that relates to the business of the Company or to the business of any parent, subsidiary, affiliate, customer or supplier of the Company or any other party with whom the Company agrees to hold information of such party in confidence (the “**Proprietary Information**”). Such Proprietary Information includes, but is not limited to, Assigned Inventions, marketing plans, product plans, business strategies, financial information, forecasts, personnel information, customer lists and data, and domain names.

Confidentiality. At all times, both during my employment and after its termination, I will keep and hold all such Proprietary Information in strict confidence and trust. I will not use or disclose any Proprietary Information without the prior written consent of the Company, except as may be necessary to perform my duties as an employee of the Company for the benefit of the Company. Upon termination of my employment with the Company, I will promptly deliver to the Company all documents and materials of any nature pertaining to my work with the Company and, upon Company request, will execute a document confirming my agreement to honor my responsibilities contained in this Agreement. I will not take with me or retain any documents or materials or copies thereof containing any Proprietary Information.

No Breach of Prior Agreement. I represent that my performance of all the terms of this Agreement and my duties as an employee of the Company will not breach any invention assignment, proprietary information, confidentiality or similar agreement with any former employer or other party. I represent that I will not bring with me to the Company or use in the performance of my duties for the Company any documents or materials or intangibles of a former employer or third party that are not generally available to the public or have not been legally transferred to the Company.

Efforts: Duty Not to Compete. I understand that my employment with the Company requires my undivided attention and effort during normal business hours. While I am employed by the Company, I will not, without the Company’s express prior written consent, provide services to, or assist in any manner, any business or third party if such services or assistance would be in direct conflict with the Company’s business interests.

Notification. I hereby authorize the Company to notify third parties including, without limitation, customers and actual or potential employers, of the terms of this Agreement and my responsibilities hereunder.

Non-Solicitation of Employees/Consultants. During my employment with the Company and for a period of one (1) year thereafter, I will not directly or indirectly solicit away employees or consultants of the Company for my own benefit or for the benefit of any other person or entity.

Non-Solicitation of Suppliers/Customers. During my employment with the Company and after termination of my employment, I will not directly or indirectly solicit or take away suppliers or customers of the Company if the identity of the supplier or customer or information about the supplier or customer relationship is a trade secret or is otherwise deemed confidential information within the meaning of California law.

Name and Likeness Rights. I hereby authorize the Company to use, reuse, and to grant others the right to use and reuse, my name, photograph, likeness (including caricature), voice, and biographical information, and any reproduction or simulation thereof, in any form of media or technology now known or hereafter developed (including, but not limited to, film, video and digital or other electronic media), both during and after my employment, for any purposes related to the Company's business, such as marketing, advertising, credits, and presentations.

Injunctive Relief. I understand that in the event of a breach or threatened breach of this Agreement by me the Company may suffer irreparable harm and will therefore be entitled to injunctive relief to enforce this Agreement.

Governing Law; Severability. This Agreement will be governed by and construed in accordance with the laws of the State of California, without giving effect to its laws pertaining to conflict of laws. If any provision of this Agreement is determined by any court or arbitrator of competent jurisdiction to be invalid, illegal or unenforceable in any respect, such provision will be enforced to the maximum extent possible given the intent of the parties hereto. If such clause or provision cannot be so enforced, such provision shall be stricken from this Agreement and the remainder of this Agreement shall be enforced as if such invalid, illegal or unenforceable clause or provision had (to the extent not enforceable) never been contained in this Agreement.

Counterparts. This Agreement may be executed in any number of counterparts, each of which when so executed and delivered will be deemed an original, and all of which together shall constitute one and the same agreement.

Entire Agreement. This Agreement and the documents referred to herein constitute the entire agreement and understanding of the parties with respect to the subject matter of this Agreement, and supersede all prior understandings and agreements, whether oral or written, between or among the parties hereto with respect to the specific subject matter hereof.

Amendment and Waivers. This Agreement may be amended only by a written agreement executed by each of the parties hereto. No amendment or waiver of, or modification of any obligation under this Agreement will be enforceable unless set forth in a writing signed by the party against which enforcement is sought. Any amendment effected in accordance with this section will be binding upon all parties hereto and each of their respective successors and assigns. No delay or failure to require performance of any provision of this Agreement shall constitute a waiver of that provision as to that or any other instance. No waiver granted under this Agreement as to any one provision herein shall constitute a subsequent waiver of such provision or of any other provision herein, nor shall it constitute the waiver of any performance other than the actual performance specially waived.

Successors and Assigns; Assignment. Except as otherwise provided in this Agreement, this Agreement, and the rights and obligations of the parties hereunder, will be binding upon and inure to the benefit of their respective successors, assigns, heirs, executors, administrators and legal representatives. The Company may assign any of its rights and obligations under this Agreement. No other party to this Agreement may assign, whether voluntarily or by operation of law, any of its rights and obligations under this Agreement, except with the prior written consent of the Company.

Further Assurances. The parties agree to execute such further documents and instruments and to take such further actions as may be reasonably necessary to carry out the purposes and intent of this Agreement.

“At Will” Employment. I understand that this Agreement does not constitute a contract of employment or obligate the Company to employ me for any stated period of time. I understand that I am an “at will” employee of the

Company and that my employment can be terminated at any time, with or without notice and with or without cause, for any reason or for no reason, by either the Company or myself. I acknowledge that any statements or representations to the contrary are ineffective, unless put into a writing signed by the Company. I further acknowledge that my participation in any stock option or benefit program is not to be construed as any assurance of continuing employment for any particular period of time. This Agreement shall be effective as of the first day of my employment by the Company, which is May 3, 2010.

* * * * *

In Witness Whereof, the parties have executed this Agreement as of 1st Sept 2010

Enphase Energy, Inc.:

Employee:

By: /s/ Paul Nahi

 /s/ Bill Rossi

Name: Paul Nahi
Title: President and CEO

Signature
Bill Rossi

Signature Page to Employee Invention Assignment and Confidentiality Agreement

EXHIBIT A

**LIST OF PRIOR INVENTIONS
AND ORIGINAL WORKS OF AUTHORSHIP**

Title

Date

Identifying Number
or Breach Description

- No inventions or improvements
 Additional Sheets Attached

Signature of Employee: /s/ Bill Rossi
Print Name of Employee: Bill Rossi

Date: 9/1/10



December 14, 2010

Dennis Hollenbeck
Santa Rosa, CA

Dear Dennis:

Enphase Energy, Inc. (the "**Company**") is pleased to offer you employment on the following terms:

- 1. Position.** Your title will be Vice President of Engineering and you will report to Paul Nahi, President and CEO. This is a full-time position. While you render services to the Company, you will not engage in any other employment, consulting or other business activity (whether full-time or part-time) that would create a conflict of interest with your duties to the Company. By signing this letter agreement, you confirm to the Company that you have no contractual commitments or other legal obligations that would prohibit you from performing your duties for the Company.
- 2. Cash Compensation.** The Company will pay you a starting salary at the rate of Two Hundred Fifty Thousand Dollars (\$250,000) per year, payable in accordance with the Company's standard payroll schedule. Your salary will be subject to adjustment pursuant to the Company's employee compensation policies in effect from time to time. In addition, during your first twelve months of employment, and subject to your continued employment with the Company, you will be eligible to receive a cash bonus of up to Fifty Thousand Dollars (\$50,000) (the "**First Year Bonus**"), based upon completion of objectives to be mutually agreed upon by you and the Company's Chief Executive Officer (the "**First Year MBO'S**"). Bonuses in future periods, subject to your continued employment with the Company, are to be mutually agreed upon by you and the Company's Chief Executive Officer. Bonus payment(s) will be paid to you within 60 days following the date that the Company determines that the applicable bonus has been earned, if any. You must be an employee in good standing on the date that an incentive compensation payment is to be paid in order to earn such payment.
- 3. Employee Benefits.** As a regular employee of the Company, you will be eligible to participate in regular health insurance, profit sharing, bonus, and other employee benefit plans if and as established by the Company for its employee from time to time. In addition to your gross salary, the Company will make an annual contribution on your behalf to the Company's 401(k) Plan of three percent (3%) of your "compensation", as set forth in the Company's 401(k)

Plan, for the preceding 12-month period, subject to the provision of the Company's 401 (k) Plan. The Company may change or ceases to make these contributions in future calendar years by providing notice in advance of the beginning of the next plan year. In addition, you will be entitled to paid vacation in accordance with the Company's vacation policy, as in effect from time to time.

4. Expenses. You will be reimbursed for reasonable legitimate business expenses incurred in the performance of your duties in accordance with the Company's expense reimbursement policies, as in effect from time to time.

5. Stock Option Grant. Following execution of this letter agreement, we will recommend to the Board of Directors of the Company that you be granted a stock option (the "**Option**") to purchase up to One Million, Nine Hundred Twenty-One Thousand, Five Hundred Fifty-Eight (1,921,558) shares of Common Stock of the Company under the Company's 2006 Equity Incentive Plan (the "**Plan**"). The exercise price per share will be equal to the fair market value per share on the date the Board approves such Option grant or on your first day of employment, whichever is later. The Option will be subject to the terms and conditions applicable to options granted under the Plan, as described in and subject to the Plan and the applicable stock option agreement. Subject to your continued employment and the terms and conditions of the Plan and applicable agreement and except as otherwise described in Section 7 below, twenty-five percent (25%) of the Option shares will vest and become exercisable twelve (12) months following your first day of employment, and the balance will vest and become exercisable in equal monthly installments over the next thirty-six (36) months of continuous services as described in the applicable stock option agreement.

With respect to the foregoing, the grant of the opportunity to purchase such shares by the Company is subject to the Board's approval and this promise to recommend such approval is not a promise of compensation and is not intended to create any obligation on the part of the Company.

6. Confidentiality. As an employee of the Company, you will have access to certain confidential information of the Company and you may, during the course of your employment, develop certain information or inventions that will be the property of the Company. To protect the interests of the Company, you will need to sign the Company's standard "Employee Invention Assignment and Confidentiality Agreement" attached hereto as Exhibit A as a condition of your employment. We wish to impress upon you that we do not want you to, and we

hereby direct you not to, bring with you any confidential or proprietary material of any former employer or to violate any other obligations you may have to any former employer. During the period that you render services to the Company, you agree to not engage in any employment, business or activity that is in any way competitive with the business or proposed business of the Company. You will disclose to the Company in writing any other gainful employment, business or activity that you are currently associated with or participate in that competes with the Company. You will not assist any other person or organization in competing with the Company or in preparing to engage in competition with the business or proposed business of the Company. You represent that your signing of this offer letter, agreement(s) concerning stock granted to you, if any, under the Plan and the Company's Employee Invention Assignment and Confidentiality Agreement and your commencement of employment with the Company will not violate any agreement currently in place between yourself and current or past employers.

7. Employment Relationship. Employment with the Company is for no specific period of time. Your employment with the Company will be "at will," meaning that either you or the Company may terminate your employment at any time and for any reason with or without cause. Any contrary representations that may have been made to you are superseded by this letter agreement. This is the full and complete agreement between you and the Company on this term. Although your job duties title, compensation and benefits, as well as the Company's personnel policies and procedures, may change from time to time, the "at will" nature of your employment may only be changed in an express written agreement signed by you and a duly authorized officer of the Company (other than you).

8. Withholding Taxes. All forms of compensation referred to in this letter agreement are subject to reduction to reflect applicable withholding and payroll taxes and other deductions required by law.

9. Interpretation, Amendment and Enforcement. This letter agreement and Exhibit A constitute the complete agreement between you and the Company, contain all of the terms of your employment with the Company and supersede any prior agreements, representations or understandings (whether written, oral or implied) between you and the Company. This letter agreement may not be amended or modified, except by an express written agreement signed by both you and a duly authorized officer of the Company. The terms of this letter agreement and the resolution of any disputes as to the meaning, effect, performance or validity of this letter agreement or arising out of, related to, or in

any way connected with, this letter agreement, your employment with the Company or any other relationship between you and the Company (the “*Disputes*”) will be governed by California law, excluding laws relating to conflicts or choice of law. You and the Company submit to the exclusive personal jurisdiction of the federal and state courts located in San Francisco and Sonoma County in connection with any Dispute or any claim related to any Dispute.

* * * * *

We hope that you will accept our offer to join the Company on the terms of this letter. You may indicate your agreement with these terms and accept this offer by signing and dating both the enclosed duplicate original of this letter agreement and the enclosed Proprietary Information and Inventions Agreement and returning them to me. This offer, if not accepted, will expire at the close of business on December 15, 2010. As required by law, your employment with the Company is contingent upon your providing legal proof of your identity and authorization to work in the United States. Your employment is also contingent upon your starting work with the Company on or before December 20, 2010.

Very truly yours,

ENPHASE ENERGY, INC.

By: /s/ Paul Nahi
Paul Nahi

Title: President and CEO

I have read and accept this employment offer:

 /s/ Dennis Hollenbeck

Signature of Dennis Hollenbeck

Dated: 16 Dec 2010

Attachment

Exhibit A: Employee Invention Assignment and Confidentiality Agreement

EXHIBIT A

EMPLOYEE INVENTION ASSIGNMENT AND CONFIDENTIALITY AGREEMENT

In consideration of, and as a condition of my employment with Enphase Energy Inc., a Delaware corporation (the “*Company*”), I hereby represent to, and agree with the Company as follows:

Purpose of Agreement. I understand that the Company is engaged in a continuous program of research, development, production and marketing in connection with its business and that it is critical for the Company to preserve and protect its Proprietary Information (as defined in Section 7 below), its rights in Inventions (as defined in Section 2 below) and in all related intellectual property rights. Accordingly, I am entering into this Employee Invention Assignment and Confidentiality Agreement (this “*Agreement*”) as a condition of my employment with the Company, whether or not I am expected to create inventions of value for the Company.

Disclosure of Inventions. I will promptly disclose in confidence to the Company all inventions, improvements, designs, original works of authorship, formulas, processes, compositions of matter, computer software programs, database, mask works, designs and trade secrets that I make or conceive or first reduce to practice or create, either alone or jointly with others, during the period of my employment, whether or not in the course of my employment, and whether or not patentable, copyrightable or protectable as trade secrets (the “*Inventions*”).

Inventions Retained and Licensed. I have attached hereto, as Exhibit A, a list describing with particularity all inventions, original works of authorship, developments, improvements, and trade secrets which were made by me prior to the commencement of my employment with the Company (collectively referred to as “*Prior Inventions*”), which belong solely to me or belong to me jointly with another, which relate in any way to any of the Company’s proposed businesses, products or research and development, and which are not assigned to the Company hereunder; or, if no such list is attached, I represent that there are no such Prior Inventions. If, in the course of my employment with the Company, I incorporate into a Company product, process or machine a Prior Invention owned by me or in which I have an interest, the Company is hereby granted and shall have a non-exclusive, royalty-free, irrevocable, perpetual, worldwide license (with the right to sublicense) to make, have made, copy, modify, make derivative

works of, use, sell and otherwise distribute such Prior Invention as part of or in connection with such product, process or machine.

Work for Hire; Assignment of Inventions. I acknowledge and agree that any copyrightable works prepared by me within the scope of my employment are “works for hire” under the Copyright Act and that the Company will be considered the author and owner of such copyrightable works. I agree that all Inventions that (i) are developed using equipment, supplies, facilities or trade secrets of the Company, (ii) result from work performed by me for the Company, or (iii) relate to the Company’s business or current or anticipated research and development (the “***Assigned Inventions***”), will be the sole and exclusive property of the Company and are hereby irrevocably assigned by me to the Company.

Labor Code Section 2870 Notice. I have been notified and understand that the provisions of Sections 3 and 5 of this Agreement do not apply to any Assigned Invention that qualifies fully under the provisions of Section 2870 of the California Labor Code, which states as follows:

ANY PROVISION IN AN EMPLOYMENT AGREEMENT WHICH PROVIDES THAT AN EMPLOYEE SHALL ASSIGN, OR OFFER TO ASSIGN ANY OF HIS OR HER RIGHTS IN AN INVENTION TO HIS OR HER EMPLOYER SHALL NOT APPLY TO AN INVENTION THAT THE EMPLOYEE DEVELOPED ENTIRELY ON HIS OR HER OWN TIME WITHOUT USING THE EMPLOYER’S EQUIPMENT, SUPPLIES, FACILITIES, OR TRADE SECRET INFORMATION EXCEPT FOR THOSE INVENTIONS THAT EITHER: (1) RELATE AT THE TIME OF CONCEPTION OR REDUCTION TO PRACTICE OF THE INVENTION TO THE EMPLOYER’S BUSINESS, OR ACTUAL OR DEMONSTRABLY ANTICIPATED RESEARCH OR DEVELOPMENT OF THE EMPLOYER; OR (2) RESULT FROM ANY WORK PERFORMED BY THE EMPLOYEE FOR THE EMPLOYER. TO THE EXTENT A PROVISION IN AN

EMPLOYMENT AGREEMENT PURPORTS TO REQUIRE AN EMPLOYEE TO ASSIGN AN INVENTION OTHERWISE EXCLUDED FROM BEING REQUIRED TO BE ASSIGNED UNDER CALIFORNIA LABOR CODE SECTION 2870(a), THE PROVISION IS AGAINST THE PUBLIC POLICY OF THIS STATE AND IS UNENFORCEABLE.

Assignment of Other Rights. In addition to the foregoing assignment of Assigned Inventions to the Company, I hereby irrevocably transfer and assign to the Company: (i) all worldwide patents, patent applications, copyrights, mask works, trade secrets and other intellectual property rights including but not limited to rights in databases, in any Assigned inventions, along with any registrations of or applications to register such rights; and (ii) any and all “Moral Rights” (as defined below) that I may have in or with respect to any Assigned Inventions. I also hereby forever waive and agree never to assert any and all Moral Rights I may have in or with respect to any Assigned Inventions, even after termination of my work on behalf of the Company. “***Moral Rights***” mean any rights to claim authorship of or credit on an Assigned Inventions, to object to or prevent to modification or destruction of any Assigned Inventions, or to withdraw from circulation or control the publication or distribution or any Assigned Inventions, and any similar right existing under judicial or statutory law of any country or subdivision thereof in the world, or under any treaty, regardless of whether or not such right is denominated or generally referred to as a “moral right.”

Assistance. I agree to assist the Company in every proper way to obtain for the Company and enforce patents, copyrights, mask work rights, trade secret rights and other legal protections for the Company’s Assigned Inventions in any and all countries. I will execute any documents that the Company may reasonably request for use in obtaining or enforcing such patents, copyrights, mask work rights, trade secrets and other legal protections. My obligations under this paragraph will continue beyond the termination of my employment with the Company provided that the Company will compensate me at a reasonable rate after such termination for time or expenses actually spent by me at the Company’s request on such assistance. I appoint the Secretary of the Company as my-attorney-in-fact to execute documents on my behalf for this purpose.

Proprietary Information. I understand that my employment by the Company creates a relationship of confidence and trust with respect to any information of a confidential or secret nature that may be disclosed to me by the Company or a third party that relates to the business of the Company or to the business of any parent, subsidiary, affiliate, customer or supplier of the Company or any other party with whom the Company agrees to hold information of such party in confidence (the “***Proprietary Information***”). Such Proprietary Information includes, but is not limited to, Assigned Inventions, marketing plans, product plans, business strategies, financial information, forecasts, personnel information, customer lists and data, and domain names.

Confidentiality. At all times, both during my employment and after its termination, I will keep and hold all such Proprietary Information in strict confidence and trust. I will not use or disclose any Proprietary Information without the prior written consent of the Company, except as may be necessary to perform my duties as an employee of the Company for the benefit of the Company. Upon termination of my employment with the Company, I will promptly deliver to the Company all document and materials of any nature pertaining to my work with the Company and, upon Company request, will execute a document confirming my agreement to honor my responsibilities contained in this Agreement. I will not take with me or retain any documents or materials or copies thereof containing any Proprietary Information.

No Breach of Prior Agreement. I represent that my performance of all the terms of this Agreement and my duties as an employee of the Company will not breach any invention assignment, proprietary information, confidentiality or similar agreement with any former employer or other party. I represent that I will not bring with me to the Company or use in the performance of my duties for the Company any documents or materials or intangibles of a former employer or third party that are not generally available to the public or have not been legally transferred to the Company.

Efforts; Duty Not to Compete. I understand that my employment with the Company requires my undivided attention and effort during normal business hours. While I am employed by the Company, I will not, without the Company’s express prior written consent, provide services to, or assist in any manner, any business or third party if such services or assistance would be in direct conflict with the Company’s business interests.

Notification. I hereby authorize the Company to notify third parties including, without limitation, customers and actual or potential employers, of the terms of this Agreement and my responsibilities hereunder.

Non-Solicitation of Employees/Consultants. During my employment with the Company and for a period of one (1) year thereafter, I will not directly or indirectly solicit away employees or consultants of the Company for my own benefit or for the benefit of any other person or entity.

Non-Solicitation of Suppliers/Customers. During my employment with the Company and after termination of my employment, I will not directly or indirectly solicit or take away suppliers or customers of the Company if the identity of the supplier or customer or information about the supplier or customer relationship is a trade secret or is otherwise deemed confidential information within the meaning of California law.

Name and Likeness Rights. I hereby authorize the Company to use, reuse, and to grant others the right to use and reuse, my name, photograph, likeness (including caricature) voice, and biographical information, and any reproduction or simulation thereof, in any form of media or technology now known or hereafter developed (including, but not limited to, film, video and digital or other electronic media), both during and after my employment, for any purposes related to the Company's business, such as marketing, advertising, credits, and presentations.

Injunctive Relief. I understand that in the event of a breach or threatened breach of this Agreement by me the Company may suffer irreparable harm and will therefore be entitled to injunctive relief to enforce this Agreement.

Governing Law; Severability. This Agreement will be governed by and construed in accordance with the laws of the State of California, without giving effect to its laws pertaining to conflict of laws. If any provision of this Agreement is determined by any court or arbitrator of competent jurisdiction to be invalid, illegal or unenforceable in any respect, such provision will be enforced to the maximum extent possible given the intent of the parties hereto. If such clause or provision cannot be so enforced, such provision shall be stricken from this Agreement and the remainder of this Agreement shall be enforced as if such invalid, illegal or unenforceable clause or provision had (to the extent not enforceable) never been contained in this Agreement.

Counterparts. This Agreement may be executed in any number of counterparts, each of which when so executed and delivered will be deemed an original, and all of which together shall constitute one and the same agreement.

Entire Agreement. This Agreement and the documents referred to herein constitute the entire agreement and understanding of the parties with respect to the subject matter of this Agreement, and supersede all prior understanding and agreements, whether oral or written, between or among the parties hereto with respect to the specific subject matter hereof.

Amendment and Waivers. This Agreement may be amended only by a written agreement executed by each the parties hereto. No amendment of or waiver of, or modification of any obligation under this Agreement will be enforceable unless set forth in a writing signed by the party against which enforcement is sought. Any amendment effected in accordance with this section will be binding upon all parties hereto and each of their respective successors and assigns. No delay or failure to require performance of any provision of this Agreement shall constitute a waiver of that provision as to that or any other instance. No waiver granted under this Agreement as to any one provision herein shall constitute a subsequent waiver of such provision or of any other provision herein, nor shall it constitute the waiver of any performance other than the actual performance specifically waived.

Successors and Assigns Assignment. Except as otherwise provided in this Agreement, this Agreement, and the rights and obligations of the parties hereunder will be binding upon and inure to the benefit of their respective successors, assigns, heirs, executors, administrators and legal representatives. The Company may assign any of its rights and obligations under this Agreement. No other party to this Agreement may assign, whether voluntarily or by operation of law, any of its rights and obligations under this Agreement, except with the prior written consent of the Company.

Further Assurances. The parties agree to execute such further documents and instruments and to take such further actions as may be reasonably necessary to carry out the purposes and intent of this Agreement.

“At Will” Employment. I understand that this Agreement does not constitute a contract of employment or obligate the Company to employ me for any stated period of time. I understand that I am an “at will” employee of the

Company and that my employment can be terminated at any time, with or without notice and with or without cause, for any reason or for no reason, by either the Company or myself. I acknowledge that any statements or representations to the contrary are ineffective, unless put into a writing signed by the Company, I further acknowledge that my participation in any stock option or benefit program is not to be construed as any assurance of continuing employment for any particular period of time. This Agreement shall be effective as of the first day of my employment by the Company, which is December 20, 2010.

In Witness Whereof, the parties have executed this Agreement as of the 16, Dec 2010

Enphase Energy, Inc.:

Employee:

By: /s/ Paul Nahi

/s/ Dennis Hollenbeck

Name: Paul Nahi
Title: President and CEO

Signature
Dennis Hollenbeck

Signature Page to Employee Invention Assignment and Confidentiality Agreement

EXHIBIT A

**LIST OF PRIOR INVENTIONS
AND ORIGINAL WORKS OF AUTHORSHIP**

Title	Date	Identifying Number or Brief Description
Media Defect Management	3 April 1990	U.S. Patent No. # 4,914,530

No inventions or improvements

Additional Sheets Attached

Signature of Employee: /s/ Dennis Hollenbeck

Print Name of Employee: Dennis Hollenbeck

Date: 16 December 2010

ENPHASE ENERGY, INC.

CHANGE IN CONTROL AND SEVERANCE AGREEMENT

This Change in Control and Severance Agreement (the "**Agreement**") is dated as of June 14, 2011, by and between Gregory S. Steele ("**Executive**") and Enphase Energy, Inc., a Delaware corporation (the "**Company**"). This Agreement is intended to provide Executive with certain benefits described herein upon the occurrence of specific events.

RECITALS

A. It is expected that another company may from time to time consider the possibility of acquiring the Company or that a Change in Control may otherwise occur, with or without the approval of the Company's Board of Directors (the "**Board**"). The Board recognizes that such consideration can be a distraction to Executive and can cause Executive to consider alternative employment opportunities. The Board has determined that it is in the best interests of the Company and its stockholders to assure that the Company will have the continued dedication and objectivity of the Executive, notwithstanding the possibility, threat or occurrence of a Change in Control (as defined below) of the Company.

B. The Company's Board believes it is in the best interests of the Company and its shareholders to retain Executive and provide incentives to Executive to continue in the service of the Company.

C. The Board further believes that it is imperative to provide Executive with certain benefits upon termination of Executive's employment in connection with a Change in Control, which benefits are intended to provide Executive with financial security and provide sufficient income and encouragement to Executive to remain with the Company, notwithstanding the possibility of a Change in Control.

D. To accomplish the foregoing objectives, the Board has directed the Company, upon execution of this Agreement by Executive, to agree to the terms provided in this Agreement.

Now therefore, in consideration of the mutual promises, covenants and agreements contained herein, and in consideration of the continuing employment of Executive by the Company, the parties hereto agree as follows:

1. At-Will Employment. Executive's employment is at-will, which means that the Company may terminate Executive's employment at any time, with or without advance notice, and with or without Cause. Similarly, Executive may resign Executive's employment at any time, with or without advance notice or Good Reason. Executive shall not receive any compensation of any kind, including, without limitation, equity award vesting acceleration and severance benefits, following Executive's last day of employment with the Company, except as expressly provided herein. Executive shall devote all reasonable efforts to the performance of Executive's duties, and shall perform such duties in good faith.

2. Benefits Upon Termination of Employment.

(a) **Termination in connection with or following a Change in Control.** If Executive's employment is terminated without Cause (and other than as a result of Executive's death or disability) or Executive resigns for Good Reason, in either case in connection with or within twenty four (24) months after a Change in Control, and provided such termination constitutes a "separation from service" (within the meaning of Treasury Regulation Section 1.409A-1(h), a "**Separation from Service**"), and provided Executive signs and allows to become effective a release substantially in the form attached hereto as **EXHIBIT A** or **EXHIBIT B**, as applicable (the "**Release**") within the time period provided therein, then the Company shall provide Executive with the following severance benefits (the "**Separation Benefits**"):

(i) The Company shall pay Executive an amount equal to three (3) months of Executive's then current base salary, ignoring any decrease in base salary that forms the basis for Good Reason, less all applicable withholdings and deductions, paid over such 3-month period (the "**Salary Continuation**"). The Salary Continuation will be paid in equal installments on the Company's regular payroll schedule and will be subject to applicable tax withholdings over the period outlined above following the date of Executive's Separation from Service as set forth in Section 3 below.

(ii) Should Executive elect to continue his health insurance benefits pursuant to the Consolidated Omnibus Budget Reconciliation Act of 1985 ("**COBRA**") and any analogous provisions of applicable state law, the Company shall pay Executive's COBRA group health insurance premiums for Executive and his eligible dependents for a period of three (3) months following the effective date of such termination of employment described in Section 2(a) (the "**COBRA Payment Period**"). References to COBRA premiums shall not include any amounts payable by Executive under an Internal Revenue Code Section 125 health care reimbursement plan. Notwithstanding the foregoing, if the Company determines, in its sole discretion, that the Company cannot provide the COBRA premium benefits without potentially incurring financial costs or penalties under applicable law (including, without limitation, Section 2716 of the Public Health Service Act), the Company shall in lieu thereof pay Executive a taxable cash amount, which payment shall be made regardless of whether Executive or Executive's eligible family members elect health care continuation coverage (the "**Health Care Benefit Payment**"). The Health Care Benefit Payment shall be paid in monthly installments on the same schedule that the COBRA Premiums would otherwise have been paid to the insurer. The Health Care Benefit Payment shall be equal to the amount that the Company would have otherwise paid for COBRA insurance premiums (which amount shall be calculated based on the premium for the first month of coverage), and shall be paid until the expiration of the COBRA Payment Period.

(iii) The vesting and/or exercisability of any outstanding equity awards held by Executive at the time of Executive's Separation from Service shall be accelerated as to 100% of the then unvested portions of such outstanding equity awards as of the date of Executive's Separation from Service.

3. Limitations And Conditions On Separation Benefits

(a) Release Prior to Payment of Benefits. Prior to the payment of any of the Separation Benefits, Executive shall execute, and allow to become effective, the Release within the time frame set forth therein, but not later than sixty (60) days following Executive's Separation from Service (the "**Release Effective Date**"). Such Release shall specifically relate to all of Executive's rights and claims in existence at the time of such execution and shall confirm Executive's continuing obligations to the Company (including but not limited to obligations under any confidentiality and/or non-solicitation agreement with the Company). No Separation Benefits will be paid prior to the Release Effective Date. Within five (5) days following the Release Effective Date, the Company will pay Executive the Separation Benefits Executive would otherwise have received on or prior to such date but for the delay in payment related to the effectiveness of the Release, with the balance of the benefits being paid as originally scheduled. Unless a Change in Control has occurred, the Board, in its sole discretion, may modify the form of the required Release to comply with applicable law and shall determine the form of the required Release, which may be incorporated into a termination agreement or other agreement with Executive. Notwithstanding the foregoing, if the Company (or, if applicable, the successor entity thereto) determines that any of the Separation Benefits constitute "deferred compensation" under Section 409A (defined below), then, solely to the extent necessary to avoid the incurrence of the adverse personal tax consequences under Section 409A, no Separation Benefits will be paid prior to the sixtieth (60th) day following Executive's Separation from Service. On the sixtieth (60th) day following the date of Separation from Service, the Company will pay to Executive in a lump sum the applicable Separation Benefits that Employee would otherwise have received on or prior to such date, with the balance of the Separation Benefits being paid as originally scheduled.

(b) Income and Employment Taxes. Executives agrees that Executive shall be responsible for any applicable taxes of any nature (including any penalties or interest that may apply to such taxes) that the Company reasonably determines apply to any payment made hereunder, that Executive's receipt of any benefit hereunder is conditioned on Executive's satisfaction of any applicable withholding or similar obligations that apply to such benefit, and that any cash payment owed hereunder will be reduced to satisfy any such withholding or similar obligations that may apply.

(c) Compliance with Section 409A. It is intended that each installment of the payments and benefits provided for in this Agreement is a separate "payment" for purposes of Treasury Regulation Section 1.409A-2(b)(2)(i). For the avoidance of doubt, it is intended that payments of the amounts set forth in this Agreement satisfy, to the greatest extent possible, the exemptions from the application of Section 409A of the Internal Revenue Code of 1986, as amended (the "**Code**") (Section 409A of the Code, together, with any state law of similar effect, "**Section 409A**") provided under Treasury Regulations 1.409A-1(b)(4), 1.409A-1(b)(5) and 1.409A-1(b)(9). However, if the Company (or, if applicable, the successor entity thereto) determines that the severance payments and benefits provided under this Agreement (the "**Agreement Payments**") constitute "deferred compensation" under Section 409A and Executive is, on the date of his Separation from Service, a "specified Executive" of the Company or any successor entity thereto, as such term is defined in Section 409A(a)(2)(B)(i) of the Code (a "**Specified Executive**"), then, solely to the extent necessary to avoid the incurrence of the adverse personal tax consequences under Section 409A, the timing of the Separation Benefit

described in Section 2(a)(i) shall be delayed as follows: on the earlier to occur of (i) the date that is six months and one day after Executive's Separation from Service or (ii) the date of Executive's death (such earlier date, the "**Delayed Initial Payment Date**"), the Company (or the successor entity thereto, as applicable) shall pay to Executive a lump sum amount equal to the applicable benefit that Executive would otherwise have received through the Delayed Initial Payment Date if the commencement of the payment of the benefit had not been so delayed pursuant to this Section 3(c).

(d) Conflicts. Executive represents that his performance of all the terms of this Agreement will not breach any other agreement to which Executive is a party. Executive has not, and will not during the term of this Agreement, enter into any oral or written agreement in conflict with any of the provisions of this Agreement. Executive further represents that Executive is entering into or has entered into an employment relationship with the Company of his own free will and that Executive has not been solicited as an employee in any way by the Company.

(e) Successors. Any successor to the Company (whether direct or indirect and whether by purchase, lease, merger, consolidation, liquidation or otherwise) to all or substantially all of the Company's business and/or assets shall assume the obligations under this Agreement and agree expressly to perform the obligations under this Agreement in the same manner and to the same extent as the Company would be required to perform such obligations in the absence of a succession. The terms of this Agreement and all of Executive's rights hereunder and thereunder shall inure to the benefit of, and be enforceable by, Executive's personal or legal representatives, executors, administrators, successors, heirs, distributees, devisees and legatees.

(f) Notice. Notices and all other communications contemplated by this Agreement shall be in writing and shall be deemed to have been duly given when personally delivered or when mailed by U.S. registered or certified mail, return receipt requested and postage prepaid. Mailed notices to Executive shall be addressed to Executive at the home address which Executive most recently communicated to the Company in writing. In the case of the Company, mailed notices shall be addressed to its corporate headquarters, and all notices shall be directed to the attention of its Chief Financial Officer.

4. Definitions.

(a) Cause. For purposes of this Agreement, "**Cause**", as determined by the Board acting in good faith and based on information then known to it, means: (A) gross negligence or willful misconduct in the performance of duties to the Company where such gross negligence or willful misconduct has resulted or is likely to result in substantial and material damage to the Company or its subsidiaries; (B) a material failure to comply with the Company's written policies after having received from the Company notice of, and a reasonable time to cure, such failure; (C) repeated unexplained or unjustified absence from the Company; (D) conviction of a felony or a crime involving moral turpitude causing material harm to the standing and reputation of the Company; or (E) unauthorized use or disclosure of any proprietary information or trade secrets of the Company or any other party to whom Executive owes an obligation of non-disclosure as a result of Executive's relationship with the Company, which use or disclosure causes or is likely to cause material harm to the Company.

(b) Good Reason. For purposes of this Agreement, “**Good Reason**” for Executive’s resignation of his employment will exist following the occurrence of any of the following without Executive’s written consent: (A) a material reduction or change in job duties, responsibilities or authority inconsistent with Executive’s position with the Company and Executive’s prior duties, responsibilities or authority, provided, however, that any change in Executive’s position after a Change in Control shall not constitute grounds for a termination for Good Reason so long as Executive remains a member of the Company’s senior management (or becomes a member of the senior management of the surviving or acquiring entity) at the same or higher base salary as immediately prior to the Change in Control with equivalent authority and responsibility; (B) a material reduction of Executive’s then current base salary, representing a reduction of more than 10 percent (10%), provided that an across-the-board reduction in the salary level of other executives of the Company by the same percentage amount as part of a general salary level reduction shall not constitute such a material salary reduction; (C) a relocation of the principal place for performance of Executive’s duties to the Company to a location more than forty (40) miles from the Company’s then current location; or (D) any material breach by the Company of this Agreement or Executive’s Employment Agreement (as defined below); provided that Executive gives written notice to the Company of the event forming the basis of the Good Reason resignation within sixty (60) days of the date the Company gives written notice to Executive of its affirmative decision to take an action set forth in (A), (B), (C) or (D) above, the Company fails to cure such basis for the Good Reason resignation within thirty (30) days after receipt of Executive’s written notice and Executive terminates his employment within thirty (30) days following the expiration of the cure period.

(c) Change in Control. For purposes of this Agreement, “**Change in Control**” means the occurrence of any of the following events: (i) any sale or exchange of the capital stock by the shareholders of the Company in one transaction or series of related transactions where more than 50% of the outstanding voting power of the Company is acquired by a person or entity or group of related persons or entities; or (ii) any reorganization, consolidation or merger of the Company where the outstanding voting securities of the Company immediately before the transaction represent or are converted into less than fifty percent 50% of the outstanding voting power of the surviving entity (or its parent corporation) immediately after the transaction; or (iii) the consummation of any transaction or series of related transactions that results in the sale of all or substantially all of the assets of the Company; or (iv) any “person” or “group” (as defined in the Securities Exchange Act of 1934, as amended (the “**Exchange Act**”)) becoming the “beneficial owner” (as defined in Rule 13d-3 under the Exchange Act) directly or indirectly of securities representing more than fifty percent (50%) of the voting power of the Company then outstanding.

5. Parachute Payments.

(a) If any payment or benefit (including payments and benefits pursuant to this Agreement) that Executive would receive in connection with a Change in Control from the Company or otherwise (“**Transaction Payment**”) would (i) constitute a “parachute payment” within the meaning of Section 280G of the Code, and (ii) but for this sentence, be subject to the excise tax imposed by Section 4999 of the Code (the “**Excise Tax**”), then the Company shall cause to be determined, before any amounts of the Transaction Payment are paid to Executive, which of the following two alternative forms of payment would result in Executive’s receipt, on an after-tax basis, of the greater amount of the Transaction Payment notwithstanding that all or

some portion of the Transaction Payment may be subject to the Excise Tax: (1) payment in full of the entire amount of the Transaction Payment (a “**Full Payment**”), or (2) payment of only a part of the Transaction Payment so that Executive receives the largest payment possible without the imposition of the Excise Tax (a “**Reduced Payment**”). For purposes of determining whether to make a Full Payment or a Reduced Payment, the Company shall cause to be taken into account all applicable federal, state and local income and employment taxes and the Excise Tax (all computed at the highest applicable marginal rate, net of the maximum reduction in federal income taxes which could be obtained from a deduction of such state and local taxes). If a Reduced Payment is made, (x) Executive shall have no rights to any additional payments and/or benefits constituting the Transaction Payment, and (y) reduction in payments and/or benefits shall occur in the manner that results in the greatest economic benefit to Executive as determined in this paragraph. If more than one method of reduction will result in the same economic benefit, the portions of the Transaction Payment shall be reduced pro rata.

(b) The professional firm engaged by the Company for general tax purposes as of the day prior to the effective date of the Change in Control shall make all determinations required to be made under this Section 5. If the professional firm so engaged by the Company is serving as accountant or auditor for the individual, entity or group effecting the Change in Control, the Company shall appoint a nationally recognized independent registered public accounting firm to make the determinations required hereunder. The Company shall bear all expenses with respect to the determinations by such professional firm required to be made hereunder.

(c) The professional firm engaged to make the determinations hereunder shall provide its calculations, together with detailed supporting documentation, to the Company and Executive within fifteen (15) calendar days after the date on which Executive’s right to a Transaction Payment is triggered or such other time as reasonably requested by the Company or Executive. If the professional firm determines that no Excise Tax is payable with respect to the Transaction Payment, either before or after the application of the Reduced Amount, it shall furnish the Company and Executive with detailed supporting calculations of its determinations that no Excise Tax will be imposed with respect to such Transaction Payment. Any good faith determinations of the professional firm made hereunder shall be final, binding and conclusive upon the Company and Executive.

6. Other Employment Terms and Conditions. The employment relationship between the parties shall be governed by the general employment policies and procedures of the Company, including those relating to the protection of confidential information and assignment of inventions; provided, however, that when the terms of this Agreement differ from or are in conflict with the Company’s general employment policies or procedures, this Agreement shall control.

7. Miscellaneous Provisions.

(a) **No Duty to Mitigate.** Executive shall not be required to mitigate the amount of any payment contemplated by this Agreement (whether by seeking new employment or in any other manner), nor shall any such payment be reduced by any earnings that Executive may receive from any other source.

(b) Waiver. No provision of this Agreement shall be modified, waived or discharged unless the modification, waiver or discharge is agreed to in writing and signed by Executive and by an authorized officer of the Company (other than Executive). No waiver by either party of any breach of, or of compliance with, any condition or provision of this Agreement by the other party shall be considered a waiver of any other condition or provision or of the same condition or provision at another time.

(c) Whole Agreement. No agreements, representations or understandings (whether oral or written and whether express or implied) which are not expressly set forth in this Agreement have been made or entered into by either party with respect to the subject matter hereof. This Agreement supersedes any agreement (or portion thereof) concerning similar subject matter dated prior to the date of this Agreement, including but not limited to Executive's offer letter with the Company dated November 15, 2007 (the "**Employment Agreement**"), and by execution of this Agreement both parties agree that any such predecessor agreement (or portion thereof) shall be deemed null and void. For the avoidance of doubt, the parties agree that this Agreement does not supersede the provisions of the Employee Agreement that do not address termination or severance benefits, the provisions of any equity plan of the Company that provides for vesting acceleration benefits on the event of a Change in Control in which the successor corporation does not assume or substitute for outstanding equity awards or Executive's Employee Invention Assignment and Confidentiality Agreement with the Company.

(d) Choice of Law. The validity, interpretation, construction and performance of this Agreement shall be governed by the laws of the State of California without reference to conflict of laws provisions.

(e) Severability. If any term or provision of this Agreement or the application thereof to any circumstance shall, in any jurisdiction and to any extent, be invalid or unenforceable, such term or provision shall be ineffective as to such jurisdiction to the extent of such invalidity or unenforceability without invalidating or rendering unenforceable the remaining terms and provisions of this Agreement or the application of such terms and provisions to circumstances other than those as to which it is held invalid or unenforceable, and a suitable and equitable term or provision shall be substituted therefor to carry out, insofar as may be valid and enforceable, the intent and purpose of the invalid or unenforceable term or provision.

(f) Arbitration. Executive and the Company agree to attempt to settle any disputes arising in connection with this Agreement through good faith consultation. In the event that Executive and the Company are not able to resolve any such disputes within fifteen (15) days after notification in writing to the other, Executive and the Company agree that any dispute or claim arising out of or in connection with this Agreement will be finally settled by binding arbitration in Sonoma County, California in accordance with the rules of the American Arbitration Association by one arbitrator mutually agreed upon by the parties. The arbitrator will apply California law, without reference to rules of conflicts of law or rules of statutory arbitration, to the resolution of any dispute. Except as set forth in Subparagraph (e) above, the arbitrator shall not have authority to modify the terms of this Agreement. The Company shall pay the costs of the arbitration proceeding. Each party shall, unless otherwise determined by the arbitrator, bear its or his own attorneys' fees and expenses, provided however that if Executive prevails in an arbitration proceeding, the Company shall reimburse Executive for his reasonable attorneys' fees and costs. Judgment on the award rendered by the arbitrator may be entered in

any court having jurisdiction thereof. Notwithstanding the foregoing, the Company and Executive may apply to any court of competent jurisdiction for preliminary or interim equitable relief, or to compel arbitration in accordance with this paragraph, without breach of this arbitration provision.

(g) Legal Fees and Expenses. The parties shall each bear their own expenses, legal fees and other fees incurred in connection with the execution of this Agreement.

(h) No Assignment of Benefits. The rights of any person to payments or benefits under this Agreement shall not be made subject to option or assignment, either by voluntary or involuntary assignment or by operation of law, including (without limitation) bankruptcy, garnishment, attachment or other creditor's process, and any action in violation of this Section 7(h) shall be void.

(i) Assignment by Company. The Company may assign its rights under this Agreement to an affiliate, and an affiliate may assign its rights under this Agreement to another affiliate of the Company or to the Company. In the case of any such assignment, the term "Company" when used in a section of this Agreement shall mean the corporation that actually employs the Executive.

(j) Counterparts. This Agreement may be executed in counterparts, each of which shall be deemed an original, but all of which together will constitute one and the same instrument.

IN WITNESS WHEREOF, the parties have executed this Agreement as of the date written below.

/s/ Gregory S. Steele

GREGORY S. STEELE

Address: _____

Date: 6/14/11

ENPHASE ENERGY, INC.

/s/ Paul Nahi

Name: Paul Nahi

Title: Chief Executive Officer

Date: 6/14/11

EXHIBIT A

RELEASE AGREEMENT

I understand and agree completely to the terms set forth in the Enphase Energy, Inc. Change in Control and Severance Agreement (the "**Agreement**").

I understand that this Release, together with the Agreement, constitutes the complete, final and exclusive embodiment of the entire agreement between the Company, affiliates of the Company and me with regard to the subject matter hereof. I am not relying on any promise or representation by the Company that is not expressly stated therein. Certain capitalized terms used in this Release are defined in the Agreement.

I hereby confirm my obligations under my Employee Invention Assignment and Confidentiality Agreement with the Company.

Except as otherwise set forth in this Release, I hereby generally and completely release the Company and its current and former directors, officers, Executives, shareholders, partners, agents, attorneys, predecessors, successors, parent and subsidiary entities, insurers, affiliates, and assigns (collectively, the "**Released Parties**") from any and all claims, liabilities and obligations, both known and unknown, that arise out of or are in any way related to events, acts, conduct, or omissions occurring prior to my signing this Release (collectively, the "**Released Claims**"). The Released Claims include, but are not limited to: (1) all claims arising out of or in any way related to my employment with the Company or its affiliates, or the termination of that employment; (2) all claims related to my compensation or benefits, including salary, bonuses, commissions, vacation pay, expense reimbursements, severance pay, fringe benefits, stock, stock options, or any other ownership interests in the Company or its affiliates; (3) all claims for breach of contract, wrongful termination, and breach of the implied covenant of good faith and fair dealing; (4) all tort claims, including claims for fraud, defamation, emotional distress, and discharge in violation of public policy; and (5) all federal, state, and local statutory claims, including claims for discrimination, harassment, retaliation, attorneys' fees, or other claims arising under the federal Civil Rights Act of 1964 (as amended), the federal Americans with Disabilities Act of 1990, the federal Age Discrimination in Employment Act of 1967 (as amended) ("**ADEA**"), the federal Employee Retirement Income Security Act of 1974 (as amended), and the California Fair Employment and Housing Act (as amended). Notwithstanding the foregoing, the following are not included in the Released Claims (the "**Excluded Claims**"): (1) any rights or claims for indemnification I may have pursuant to any written indemnification agreement with the Company to which I am a party, the charter or bylaws of the Company, or under applicable law; or (2) any rights which are not waivable as a matter of law. In addition, nothing in this Release prevents me from filing, cooperating with, or participating in any proceeding before the Equal Employment Opportunity Commission, the Department of Labor, the California Department of Fair Employment and Housing, or any other local, state, or federal administrative body or government agency that is authorized to enforce or administer laws related to employment, against the Company, except that I hereby waive my right to any monetary benefits in connection with any such claim, charge or proceeding. I hereby represent and warrant that, other than the Excluded Claims, I am not aware of any claims I have or might have against any of the Released Parties that are not included in the Released Claims.

I acknowledge that I am knowingly and voluntarily waiving and releasing any rights I may have under the ADEA. I also acknowledge that the consideration given for the Released Claims is in addition to anything of value to which I was already entitled. I further acknowledge that I have been advised by this writing, as required by the ADEA, that: (a) the Released Claims do not apply to any rights or claims that arise after the date I sign this Release; (b) I should consult with an attorney prior to signing this Release (although I may choose voluntarily not to do so); (c) I have forty-five (45) days to consider this Release (although I may choose to voluntarily sign it sooner); (d) I have seven (7) days following the date I sign this Release to revoke the Release by providing written notice to an officer of the Company; and (e) the Release will not be effective until the date upon which the revocation period has expired unexercised, which will be the eighth day after I sign this Release ("**Effective Date**").

I have received with this Release all of the information required by the ADEA, including without limitation a detailed list of the job titles and ages of all Executives who were terminated in this group termination and the ages of all Executives of the Company in the same job classification or organizational unit who were not terminated, along with information on the eligibility factors used to select Executives for the group termination and any time limits applicable to this group termination program.

I acknowledge that I have read and understand Section 1542 of the California Civil Code which reads as follows: "**A general release does not extend to claims which the creditor does not know or suspect to exist in his or her favor at the time of executing the release, which if known by him or her must have materially affected his or her settlement with the debtor.**" I hereby expressly waive and relinquish all rights and benefits under that section and any law of any jurisdiction of similar effect with respect to my release of any claims hereunder.

I hereby represent that I have been paid all compensation owed and for all hours worked, I have received all the leave and leave benefits and protections for which I am eligible, and I have not suffered any on-the-job injury for which I have not already filed a workers' compensation claim.

I hereby agree not to disparage the Company, or its officers, directors, Executives, shareholders or agents, in any manner likely to be harmful to its or their business, business reputation, or personal reputation; *provided, however*, that I will respond accurately and fully to any question, inquiry or request for information when required by legal process.

I acknowledge that to become effective, I must sign and return this Release to the Company so that it is received not later than forty-five (45) days following the date it is provided to me, and I must not revoke it thereafter.

GREGORY S. STEELE

Date: _____

EXHIBIT B
RELEASE AGREEMENT

I understand and agree completely to the terms set forth in the Enphase Energy, Inc. Change in Control and Severance Agreement (the "**Agreement**").

I understand that this Release, together with the Agreement, constitutes the complete, final and exclusive embodiment of the entire agreement between the Company, affiliates of the Company and me with regard to the subject matter hereof. I am not relying on any promise or representation by the Company that is not expressly stated therein. Certain capitalized terms used in this Release are defined in the Agreement.

I hereby confirm my obligations under my Employee Invention Assignment and Confidentiality Agreement with the Company.

Except as otherwise set forth in this Release, I hereby generally and completely release the Company and its current and former directors, officers, Executives, shareholders, partners, agents, attorneys, predecessors, successors, parent and subsidiary entities, insurers, affiliates, and assigns (collectively, the "**Released Parties**") from any and all claims, liabilities and obligations, both known and unknown, that arise out of or are in any way related to events, acts, conduct, or omissions occurring prior to my signing this Release (collectively, the "**Released Claims**"). The Released Claims include, but are not limited to: (1) all claims arising out of or in any way related to my employment with the Company or its affiliates, or the termination of that employment; (2) all claims related to my compensation or benefits, including salary, bonuses, commissions, vacation pay, expense reimbursements, severance pay, fringe benefits, stock, stock options, or any other ownership interests in the Company or its affiliates; (3) all claims for breach of contract, wrongful termination, and breach of the implied covenant of good faith and fair dealing; (4) all tort claims, including claims for fraud, defamation, emotional distress, and discharge in violation of public policy; and (5) all federal, state, and local statutory claims, including claims for discrimination, harassment, retaliation, attorneys' fees, or other claims arising under the federal Civil Rights Act of 1964 (as amended), the federal Americans with Disabilities Act of 1990, the federal Age Discrimination in Employment Act of 1967 (as amended) ("**ADEA**"), the federal Executive Retirement Income Security Act of 1974 (as amended), and the California Fair Employment and Housing Act (as amended). Notwithstanding the foregoing, the following are not included in the Released Claims (the "**Excluded Claims**"): (1) any rights or claims for indemnification I may have pursuant to any written indemnification agreement with the Company to which I am a party, the charter or bylaws of the Company, or under applicable law; or (2) any rights which are not waivable as a matter of law. In addition, nothing in this Release prevents me from filing, cooperating with, or participating in any proceeding before the Equal Employment Opportunity Commission, the Department of Labor, the California Department of Fair Employment and Housing, or any other local, state, or federal administrative body or government agency that is authorized to enforce or administer laws related to employment, against the Company, except that I hereby waive my right to any monetary benefits in connection with any such claim, charge or proceeding. I hereby represent

and warrant that, other than the Excluded Claims, I am not aware of any claims I have or might have against any of the Released Parties that are not included in the Released Claims.

I acknowledge that I am knowingly and voluntarily waiving and releasing any rights I may have under the ADEA. I also acknowledge that the consideration given for the Released Claims is in addition to anything of value to which I was already entitled. I further acknowledge that I have been advised by this writing, as required by the ADEA, that: (a) the Released Claims do not apply to any rights or claims that arise after the date I sign this Release; (b) I should consult with an attorney prior to signing this Release (although I may choose voluntarily not to do so); (c) I have twenty-one (21) days to consider this Release (although I may choose to voluntarily sign it sooner); (d) I have seven (7) days following the date I sign this Release to revoke the Release by providing written notice to an officer of the Company; and (e) the Release will not be effective until the date upon which the revocation period has expired unexercised, which will be the eighth day after I sign this Release ("**Effective Date**").

I acknowledge that I have read and understand Section 1542 of the California Civil Code which reads as follows: "**A general release does not extend to claims which the creditor does not know or suspect to exist in his or her favor at the time of executing the release, which if known by him or her must have materially affected his or her settlement with the debtor.**" I hereby expressly waive and relinquish all rights and benefits under that section and any law of any jurisdiction of similar effect with respect to my release of any claims hereunder.

I hereby represent that I have been paid all compensation owed and for all hours worked, I have received all the leave and leave benefits and protections for which I am eligible, and I have not suffered any on-the-job injury for which I have not already filed a workers' compensation claim.

I hereby agree not to disparage the Company, or its officers, directors, Executives, shareholders or agents, in any manner likely to be harmful to its or their business, business reputation, or personal reputation; *provided, however*, that I will respond accurately and fully to any question, inquiry or request for information when required by legal process.

I acknowledge that to become effective, I must sign and return this Release to the Company so that it is received not later than twenty-one (21) days following the date it is provided to me, and I must not revoke it thereafter.

GREGORY S. STEELE

Date: _____

ENPHASE ENERGY, INC.

CHANGE IN CONTROL AND SEVERANCE AGREEMENT

This Change in Control and Severance Agreement (the “**Agreement**”) is dated as of June 14, 2011, by and between Bill Rossi (“**Executive**”) and Enphase Energy, Inc., a Delaware corporation (the “**Company**”). This Agreement is intended to provide Executive with certain benefits described herein upon the occurrence of specific events.

RECITALS

A. It is expected that another company may from time to time consider the possibility of acquiring the Company or that a Change in Control may otherwise occur, with or without the approval of the Company’s Board of Directors (the “**Board**”). The Board recognizes that such consideration can be a distraction to Executive and can cause Executive to consider alternative employment opportunities. The Board has determined that it is in the best interests of the Company and its stockholders to assure that the Company will have the continued dedication and objectivity of the Executive, notwithstanding the possibility, threat or occurrence of a Change in Control (as defined below) of the Company.

B. The Company’s Board believes it is in the best interests of the Company and its shareholders to retain Executive and provide incentives to Executive to continue in the service of the Company.

C. The Board further believes that it is imperative to provide Executive with certain benefits upon termination of Executive’s employment in connection with a Change in Control, which benefits are intended to provide Executive with financial security and provide sufficient income and encouragement to Executive to remain with the Company, notwithstanding the possibility of a Change in Control.

D. To accomplish the foregoing objectives, the Board has directed the Company, upon execution of this Agreement by Executive, to agree to the terms provided in this Agreement.

Now therefore, in consideration of the mutual promises, covenants and agreements contained herein, and in consideration of the continuing employment of Executive by the Company, the parties hereto agree as follows:

1. At-Will Employment. Executive’s employment is at-will, which means that the Company may terminate Executive’s employment at any time, with or without advance notice, and with or without Cause. Similarly, Executive may resign Executive’s employment at any time, with or without advance notice or Good Reason. Executive shall not receive any compensation of any kind, including, without limitation, equity award vesting acceleration and severance benefits, following Executive’s last day of employment with the Company, except as expressly provided herein. Executive shall devote all reasonable efforts to the performance of Executive’s duties, and shall perform such duties in good faith.

1.

2. Benefits Upon Termination of Employment.

(a) **Termination in connection with or following a Change in Control.** If Executive's employment is terminated without Cause (and other than as a result of Executive's death or disability) or Executive resigns for Good Reason, in either case in connection with or within twenty four (24) months after a Change in Control, and provided such termination constitutes a "separation from service" (within the meaning of Treasury Regulation Section 1.409A-1(h), a "**Separation from Service**"), and provided Executive signs and allows to become effective a release substantially in the form attached hereto as **EXHIBIT A** or **EXHIBIT B**, as applicable (the "**Release**") within the time period provided therein, then the Company shall provide Executive with the following severance benefits (the "**Separation Benefits**"):

(i) The Company shall pay Executive an amount equal to three (3) months of Executive's then current base salary, ignoring any decrease in base salary that forms the basis for Good Reason, less all applicable withholdings and deductions, paid over such 3-month period (the "**Salary Continuation**"). The Salary Continuation will be paid in equal installments on the Company's regular payroll schedule and will be subject to applicable tax withholdings over the period outlined above following the date of Executive's Separation from Service as set forth in Section 3 below.

(ii) Should Executive elect to continue his health insurance benefits pursuant to the Consolidated Omnibus Budget Reconciliation Act of 1985 ("**COBRA**") and any analogous provisions of applicable state law, the Company shall pay Executive's COBRA group health insurance premiums for Executive and his eligible dependents for a period of three (3) months following the effective date of such termination of employment described in Section 2(a) (the "**COBRA Payment Period**"). References to COBRA premiums shall not include any amounts payable by Executive under an Internal Revenue Code Section 125 health care reimbursement plan. Notwithstanding the foregoing, if the Company determines, in its sole discretion, that the Company cannot provide the COBRA premium benefits without potentially incurring financial costs or penalties under applicable law (including, without limitation, Section 2716 of the Public Health Service Act), the Company shall in lieu thereof pay Executive a taxable cash amount, which payment shall be made regardless of whether Executive or Executive's eligible family members elect health care continuation coverage (the "**Health Care Benefit Payment**"). The Health Care Benefit Payment shall be paid in monthly installments on the same schedule that the COBRA Premiums would otherwise have been paid to the insurer. The Health Care Benefit Payment shall be equal to the amount that the Company would have otherwise paid for COBRA insurance premiums (which amount shall be calculated based on the premium for the first month of coverage), and shall be paid until the expiration of the COBRA Payment Period.

(iii) The vesting and/or exercisability of any outstanding equity awards held by Executive at the time of Executive's Separation from Service shall be accelerated as to 100% of the then unvested portions of such outstanding equity awards as of the date of Executive's Separation from Service.

3. Limitations And Conditions On Separation Benefits

(a) Release Prior to Payment of Benefits. Prior to the payment of any of the Separation Benefits, Executive shall execute, and allow to become effective, the Release within the time frame set forth therein, but not later than sixty (60) days following Executive's Separation from Service (the "**Release Effective Date**"). Such Release shall specifically relate to all of Executive's rights and claims in existence at the time of such execution and shall confirm Executive's continuing obligations to the Company (including but not limited to obligations under any confidentiality and/or non-solicitation agreement with the Company). No Separation Benefits will be paid prior to the Release Effective Date. Within five (5) days following the Release Effective Date, the Company will pay Executive the Separation Benefits Executive would otherwise have received on or prior to such date but for the delay in payment related to the effectiveness of the Release, with the balance of the benefits being paid as originally scheduled. Unless a Change in Control has occurred, the Board, in its sole discretion, may modify the form of the required Release to comply with applicable law and shall determine the form of the required Release, which may be incorporated into a termination agreement or other agreement with Executive. Notwithstanding the foregoing, if the Company (or, if applicable, the successor entity thereto) determines that any of the Separation Benefits constitute "deferred compensation" under Section 409A (defined below), then, solely to the extent necessary to avoid the incurrence of the adverse personal tax consequences under Section 409A, no Separation Benefits will be paid prior to the sixtieth (60th) day following Executive's Separation from Service. On the sixtieth (60th) day following the date of Separation from Service, the Company will pay to Executive in a lump sum the applicable Separation Benefits that Employee would otherwise have received on or prior to such date, with the balance of the Separation Benefits being paid as originally scheduled.

(b) Income and Employment Taxes. Executives agrees that Executive shall be responsible for any applicable taxes of any nature (including any penalties or interest that may apply to such taxes) that the Company reasonably determines apply to any payment made hereunder, that Executive's receipt of any benefit hereunder is conditioned on Executive's satisfaction of any applicable withholding or similar obligations that apply to such benefit, and that any cash payment owed hereunder will be reduced to satisfy any such withholding or similar obligations that may apply.

(c) Compliance with Section 409A. It is intended that each installment of the payments and benefits provided for in this Agreement is a separate "payment" for purposes of Treasury Regulation Section 1.409A-2(b)(2)(i). For the avoidance of doubt, it is intended that payments of the amounts set forth in this Agreement satisfy, to the greatest extent possible, the exemptions from the application of Section 409A of the Internal Revenue Code of 1986, as amended (the "**Code**") (Section 409A of the Code, together, with any state law of similar effect, "**Section 409A**") provided under Treasury Regulations 1.409A-1(b)(4), 1.409A-1(b)(5) and 1.409A-1(b)(9). However, if the Company (or, if applicable, the successor entity thereto) determines that the severance payments and benefits provided under this Agreement (the "**Agreement Payments**") constitute "deferred compensation" under Section 409A and Executive is, on the date of his Separation from Service, a "specified Executive" of the Company or any successor entity thereto, as such term is defined in Section 409A(a)(2)(B)(i) of the Code (a "**Specified Executive**"), then, solely to the extent necessary to avoid the incurrence of the adverse personal tax consequences under Section 409A, the timing of the Separation Benefit

described in Section 2(a)(i) shall be delayed as follows: on the earlier to occur of (i) the date that is six months and one day after Executive's Separation from Service or (ii) the date of Executive's death (such earlier date, the "**Delayed Initial Payment Date**"), the Company (or the successor entity thereto, as applicable) shall pay to Executive a lump sum amount equal to the applicable benefit that Executive would otherwise have received through the Delayed Initial Payment Date if the commencement of the payment of the benefit had not been so delayed pursuant to this Section 3(c).

(d) Conflicts. Executive represents that his performance of all the terms of this Agreement will not breach any other agreement to which Executive is a party. Executive has not, and will not during the term of this Agreement, enter into any oral or written agreement in conflict with any of the provisions of this Agreement. Executive further represents that Executive is entering into or has entered into an employment relationship with the Company of his own free will and that Executive has not been solicited as an employee in any way by the Company.

(e) Successors. Any successor to the Company (whether direct or indirect and whether by purchase, lease, merger, consolidation, liquidation or otherwise) to all or substantially all of the Company's business and/or assets shall assume the obligations under this Agreement and agree expressly to perform the obligations under this Agreement in the same manner and to the same extent as the Company would be required to perform such obligations in the absence of a succession. The terms of this Agreement and all of Executive's rights hereunder and thereunder shall inure to the benefit of, and be enforceable by, Executive's personal or legal representatives, executors, administrators, successors, heirs, distributees, devisees and legatees.

(f) Notice. Notices and all other communications contemplated by this Agreement shall be in writing and shall be deemed to have been duly given when personally delivered or when mailed by U.S. registered or certified mail, return receipt requested and postage prepaid. Mailed notices to Executive shall be addressed to Executive at the home address which Executive most recently communicated to the Company in writing. In the case of the Company, mailed notices shall be addressed to its corporate headquarters, and all notices shall be directed to the attention of its Chief Financial Officer.

4. Definitions.

(a) Cause. For purposes of this Agreement, "**Cause**", as determined by the Board acting in good faith and based on information then known to it, means: (A) gross negligence or willful misconduct in the performance of duties to the Company where such gross negligence or willful misconduct has resulted or is likely to result in substantial and material damage to the Company or its subsidiaries; (B) a material failure to comply with the Company's written policies after having received from the Company notice of, and a reasonable time to cure, such failure; (C) repeated unexplained or unjustified absence from the Company; (D) conviction of a felony or a crime involving moral turpitude causing material harm to the standing and reputation of the Company; or (E) unauthorized use or disclosure of any proprietary information or trade secrets of the Company or any other party to whom Executive owes an obligation of non-disclosure as a result of Executive's relationship with the Company, which use or disclosure causes or is likely to cause material harm to the Company.

(b) Good Reason. For purposes of this Agreement, “Good Reason” for Executive’s resignation of his employment will exist following the occurrence of any of the following without Executive’s written consent: (A) a material reduction or change in job duties, responsibilities or authority inconsistent with Executive’s position with the Company and Executive’s prior duties, responsibilities or authority, provided, however, that any change in Executive’s position after a Change in Control shall not constitute grounds for a termination for Good Reason so long as Executive remains a member of the Company’s senior management (or becomes a member of the senior management of the surviving or acquiring entity) at the same or higher base salary as immediately prior to the Change in Control with equivalent authority and responsibility; (B) a material reduction of Executive’s then current base salary, representing a reduction of more than 10 percent (10%), provided that an across-the-board reduction in the salary level of other executives of the Company by the same percentage amount as part of a general salary level reduction shall not constitute such a material salary reduction; (C) a relocation of the principal place for performance of Executive’s duties to the Company to a location more than forty (40) miles from the Company’s then current location; or (D) any material breach by the Company of this Agreement or Executive’s Employment Agreement (as defined below); provided that Executive gives written notice to the Company of the event forming the basis of the Good Reason resignation within sixty (60) days of the date the Company gives written notice to Executive of its affirmative decision to take an action set forth in (A), (B), (C) or (D) above, the Company fails to cure such basis for the Good Reason resignation within thirty (30) days after receipt of Executive’s written notice and Executive terminates his employment within thirty (30) days following the expiration of the cure period.

(c) Change in Control. For purposes of this Agreement, “*Change in Control*” means the occurrence of any of the following events: (i) any sale or exchange of the capital stock by the shareholders of the Company in one transaction or series of related transactions where more than 50% of the outstanding voting power of the Company is acquired by a person or entity or group of related persons or entities; or (ii) any reorganization, consolidation or merger of the Company where the outstanding voting securities of the Company immediately before the transaction represent or are converted into less than fifty percent 50% of the outstanding voting power of the surviving entity (or its parent corporation) immediately after the transaction; or (iii) the consummation of any transaction or series of related transactions that results in the sale of all or substantially all of the assets of the Company; or (iv) any “person” or “group” (as defined in the Securities Exchange Act of 1934, as amended (the “*Exchange Act*”)) becoming the “beneficial owner” (as defined in Rule 13d-3 under the Exchange Act) directly or indirectly of securities representing more than fifty percent (50%) of the voting power of the Company then outstanding.

5. Parachute Payments.

(a) If any payment or benefit (including payments and benefits pursuant to this Agreement) that Executive would receive in connection with a Change in Control from the Company or otherwise (“*Transaction Payment*”) would (i) constitute a “parachute payment” within the meaning of Section 280G of the Code, and (ii) but for this sentence, be subject to the excise tax imposed by Section 4999 of the Code (the “*Excise Tax*”), then the Company shall cause to be determined, before any amounts of the Transaction Payment are paid to Executive, which of the following two alternative forms of payment would result in Executive’s receipt, on an after-tax basis, of the greater amount of the Transaction Payment notwithstanding that all or

some portion of the Transaction Payment may be subject to the Excise Tax: (1) payment in full of the entire amount of the Transaction Payment (a “**Full Payment**”), or (2) payment of only a part of the Transaction Payment so that Executive receives the largest payment possible without the imposition of the Excise Tax (a “**Reduced Payment**”). For purposes of determining whether to make a Full Payment or a Reduced Payment, the Company shall cause to be taken into account all applicable federal, state and local income and employment taxes and the Excise Tax (all computed at the highest applicable marginal rate, net of the maximum reduction in federal income taxes which could be obtained from a deduction of such state and local taxes). If a Reduced Payment is made, (x) Executive shall have no rights to any additional payments and/or benefits constituting the Transaction Payment, and (y) reduction in payments and/or benefits shall occur in the manner that results in the greatest economic benefit to Executive as determined in this paragraph. If more than one method of reduction will result in the same economic benefit, the portions of the Transaction Payment shall be reduced pro rata.

(b) The professional firm engaged by the Company for general tax purposes as of the day prior to the effective date of the Change in Control shall make all determinations required to be made under this Section 5. If the professional firm so engaged by the Company is serving as accountant or auditor for the individual, entity or group effecting the Change in Control, the Company shall appoint a nationally recognized independent registered public accounting firm to make the determinations required hereunder. The Company shall bear all expenses with respect to the determinations by such professional firm required to be made hereunder.

(c) The professional firm engaged to make the determinations hereunder shall provide its calculations, together with detailed supporting documentation, to the Company and Executive within fifteen (15) calendar days after the date on which Executive’s right to a Transaction Payment is triggered or such other time as reasonably requested by the Company or Executive. If the professional firm determines that no Excise Tax is payable with respect to the Transaction Payment, either before or after the application of the Reduced Amount, it shall furnish the Company and Executive with detailed supporting calculations of its determinations that no Excise Tax will be imposed with respect to such Transaction Payment. Any good faith determinations of the professional firm made hereunder shall be final, binding and conclusive upon the Company and Executive.

6. Other Employment Terms and Conditions. The employment relationship between the parties shall be governed by the general employment policies and procedures of the Company, including those relating to the protection of confidential information and assignment of inventions; provided, however, that when the terms of this Agreement differ from or are in conflict with the Company’s general employment policies or procedures, this Agreement shall control.

7. Miscellaneous Provisions.

(a) **No Duty to Mitigate.** Executive shall not be required to mitigate the amount of any payment contemplated by this Agreement (whether by seeking new employment or in any other manner), nor shall any such payment be reduced by any earnings that Executive may receive from any other source.

(b) Waiver. No provision of this Agreement shall be modified, waived or discharged unless the modification, waiver or discharge is agreed to in writing and signed by Executive and by an authorized officer of the Company (other than Executive). No waiver by either party of any breach of, or of compliance with, any condition or provision of this Agreement by the other party shall be considered a waiver of any other condition or provision or of the same condition or provision at another time.

(c) Whole Agreement. No agreements, representations or understandings (whether oral or written and whether express or implied) which are not expressly set forth in this Agreement have been made or entered into by either party with respect to the subject matter hereof. This Agreement supersedes any agreement (or portion thereof) concerning similar subject matter dated prior to the date of this Agreement, including but not limited to Executive's offer letter with the Company dated August 23, 2010 (the "**Employment Agreement**"), and by execution of this Agreement both parties agree that any such predecessor agreement (or portion thereof) shall be deemed null and void. For the avoidance of doubt, the parties agree that this Agreement does not supersede the provisions of the Employee Agreement that do not address termination or severance benefits, the provisions of any equity plan of the Company that provides for vesting acceleration benefits on the event of a Change in Control in which the successor corporation does not assume or substitute for outstanding equity awards or Executive's Employee Invention Assignment and Confidentiality Agreement with the Company.

(d) Choice of Law. The validity, interpretation, construction and performance of this Agreement shall be governed by the laws of the State of California without reference to conflict of laws provisions.

(e) Severability. If any term or provision of this Agreement or the application thereof to any circumstance shall, in any jurisdiction and to any extent, be invalid or unenforceable, such term or provision shall be ineffective as to such jurisdiction to the extent of such invalidity or unenforceability without invalidating or rendering unenforceable the remaining terms and provisions of this Agreement or the application of such terms and provisions to circumstances other than those as to which it is held invalid or unenforceable, and a suitable and equitable term or provision shall be substituted therefor to carry out, insofar as may be valid and enforceable, the intent and purpose of the invalid or unenforceable term or provision.

(f) Arbitration. Executive and the Company agree to attempt to settle any disputes arising in connection with this Agreement through good faith consultation. In the event that Executive and the Company are not able to resolve any such disputes within fifteen (15) days after notification in writing to the other, Executive and the Company agree that any dispute or claim arising out of or in connection with this Agreement will be finally settled by binding arbitration in Sonoma County, California in accordance with the rules of the American Arbitration Association by one arbitrator mutually agreed upon by the parties. The arbitrator will apply California law, without reference to rules of conflicts of law or rules of statutory arbitration, to the resolution of any dispute. Except as set forth in Subparagraph (e) above, the arbitrator shall not have authority to modify the terms of this Agreement. The Company shall pay the costs of the arbitration proceeding. Each party shall, unless otherwise determined by the arbitrator, bear its or his own attorneys' fees and expenses, provided however that if Executive prevails in an arbitration proceeding, the Company shall reimburse Executive for his reasonable attorneys' fees and costs. Judgment on the award rendered by the arbitrator may be entered in

any court having jurisdiction thereof. Notwithstanding the foregoing, the Company and Executive may apply to any court of competent jurisdiction for preliminary or interim equitable relief, or to compel arbitration in accordance with this paragraph, without breach of this arbitration provision.

(g) Legal Fees and Expenses. The parties shall each bear their own expenses, legal fees and other fees incurred in connection with the execution of this Agreement.

(h) No Assignment of Benefits. The rights of any person to payments or benefits under this Agreement shall not be made subject to option or assignment, either by voluntary or involuntary assignment or by operation of law, including (without limitation) bankruptcy, garnishment, attachment or other creditor's process, and any action in violation of this Section 7(h) shall be void.

(i) Assignment by Company. The Company may assign its rights under this Agreement to an affiliate, and an affiliate may assign its rights under this Agreement to another affiliate of the Company or to the Company. In the case of any such assignment, the term "Company" when used in a section of this Agreement shall mean the corporation that actually employs the Executive.

(j) Counterparts. This Agreement may be executed in counterparts, each of which shall be deemed an original, but all of which together will constitute one and the same instrument.

IN WITNESS WHEREOF, the parties have executed this Agreement as of the date written below.

/s/ Bill Rossi

BILL ROSSI

Address: _____

Date: 6/14/11

ENPHASE ENERGY, INC.

/s/ Paul Nahi

Name: Paul Nahi

Title: Chief Executive Officer

Date: 6/14/11

EXHIBIT A
RELEASE AGREEMENT

I understand and agree completely to the terms set forth in the Enphase Energy, Inc. Change in Control and Severance Agreement (the "**Agreement**").

I understand that this Release, together with the Agreement, constitutes the complete, final and exclusive embodiment of the entire agreement between the Company, affiliates of the Company and me with regard to the subject matter hereof. I am not relying on any promise or representation by the Company that is not expressly stated therein. Certain capitalized terms used in this Release are defined in the Agreement.

I hereby confirm my obligations under my Employee Invention Assignment and Confidentiality Agreement with the Company.

Except as otherwise set forth in this Release, I hereby generally and completely release the Company and its current and former directors, officers, Executives, shareholders, partners, agents, attorneys, predecessors, successors, parent and subsidiary entities, insurers, affiliates, and assigns (collectively, the "**Released Parties**") from any and all claims, liabilities and obligations, both known and unknown, that arise out of or are in any way related to events, acts, conduct, or omissions occurring prior to my signing this Release (collectively, the "**Released Claims**"). The Released Claims include, but are not limited to: (1) all claims arising out of or in any way related to my employment with the Company or its affiliates, or the termination of that employment; (2) all claims related to my compensation or benefits, including salary, bonuses, commissions, vacation pay, expense reimbursements, severance pay, fringe benefits, stock, stock options, or any other ownership interests in the Company or its affiliates; (3) all claims for breach of contract, wrongful termination, and breach of the implied covenant of good faith and fair dealing; (4) all tort claims, including claims for fraud, defamation, emotional distress, and discharge in violation of public policy; and (5) all federal, state, and local statutory claims, including claims for discrimination, harassment, retaliation, attorneys' fees, or other claims arising under the federal Civil Rights Act of 1964 (as amended), the federal Americans with Disabilities Act of 1990, the federal Age Discrimination in Employment Act of 1967 (as amended) ("**ADEA**"), the federal Employee Retirement Income Security Act of 1974 (as amended), and the California Fair Employment and Housing Act (as amended). Notwithstanding the foregoing, the following are not included in the Released Claims (the "**Excluded Claims**"): (1) any rights or claims for indemnification I may have pursuant to any written indemnification agreement with the Company to which I am a party, the charter or bylaws of the Company, or under applicable law; or (2) any rights which are not waivable as a matter of law. In addition, nothing in this Release prevents me from filing, cooperating with, or participating in any proceeding before the Equal Employment Opportunity Commission, the Department of Labor, the California Department of Fair Employment and Housing, or any other local, state, or federal administrative body or government agency that is authorized to enforce or administer laws related to employment, against the Company, except that I hereby waive my right to any monetary benefits in connection with any such claim, charge or proceeding. I hereby represent and warrant that, other than the Excluded Claims, I am not aware of any claims I have or might have against any of the Released Parties that are not included in the Released Claims.

I acknowledge that I am knowingly and voluntarily waiving and releasing any rights I may have under the ADEA. I also acknowledge that the consideration given for the Released Claims is in addition to anything of value to which I was already entitled. I further acknowledge that I have been advised by this writing, as required by the ADEA, that: (a) the Released Claims do not apply to any rights or claims that arise after the date I sign this Release; (b) I should consult with an attorney prior to signing this Release (although I may choose voluntarily not to do so); (c) I have forty-five (45) days to consider this Release (although I may choose to voluntarily sign it sooner); (d) I have seven (7) days following the date I sign this Release to revoke the Release by providing written notice to an officer of the Company; and (e) the Release will not be effective until the date upon which the revocation period has expired unexercised, which will be the eighth day after I sign this Release ("**Effective Date**").

I have received with this Release all of the information required by the ADEA, including without limitation a detailed list of the job titles and ages of all Executives who were terminated in this group termination and the ages of all Executives of the Company in the same job classification or organizational unit who were not terminated, along with information on the eligibility factors used to select Executives for the group termination and any time limits applicable to this group termination program.

I acknowledge that I have read and understand Section 1542 of the California Civil Code which reads as follows: "**A general release does not extend to claims which the creditor does not know or suspect to exist in his or her favor at the time of executing the release, which if known by him or her must have materially affected his or her settlement with the debtor.**" I hereby expressly waive and relinquish all rights and benefits under that section and any law of any jurisdiction of similar effect with respect to my release of any claims hereunder.

I hereby represent that I have been paid all compensation owed and for all hours worked, I have received all the leave and leave benefits and protections for which I am eligible, and I have not suffered any on-the-job injury for which I have not already filed a workers' compensation claim.

I hereby agree not to disparage the Company, or its officers, directors, Executives, shareholders or agents, in any manner likely to be harmful to its or their business, business reputation, or personal reputation; *provided, however*, that I will respond accurately and fully to any question, inquiry or request for information when required by legal process.

I acknowledge that to become effective, I must sign and return this Release to the Company so that it is received not later than forty-five (45) days following the date it is provided to me, and I must not revoke it thereafter.

BILL ROSSI

Date: _____

EXHIBIT B
RELEASE AGREEMENT

I understand and agree completely to the terms set forth in the Enphase Energy, Inc. Change in Control and Severance Agreement (the "**Agreement**").

I understand that this Release, together with the Agreement, constitutes the complete, final and exclusive embodiment of the entire agreement between the Company, affiliates of the Company and me with regard to the subject matter hereof. I am not relying on any promise or representation by the Company that is not expressly stated therein. Certain capitalized terms used in this Release are defined in the Agreement.

I hereby confirm my obligations under my Employee Invention Assignment and Confidentiality Agreement with the Company.

Except as otherwise set forth in this Release, I hereby generally and completely release the Company and its current and former directors, officers, Executives, shareholders, partners, agents, attorneys, predecessors, successors, parent and subsidiary entities, insurers, affiliates, and assigns (collectively, the "**Released Parties**") from any and all claims, liabilities and obligations, both known and unknown, that arise out of or are in any way related to events, acts, conduct, or omissions occurring prior to my signing this Release (collectively, the "**Released Claims**"). The Released Claims include, but are not limited to: (1) all claims arising out of or in any way related to my employment with the Company or its affiliates, or the termination of that employment; (2) all claims related to my compensation or benefits, including salary, bonuses, commissions, vacation pay, expense reimbursements, severance pay, fringe benefits, stock, stock options, or any other ownership interests in the Company or its affiliates; (3) all claims for breach of contract, wrongful termination, and breach of the implied covenant of good faith and fair dealing; (4) all tort claims, including claims for fraud, defamation, emotional distress, and discharge in violation of public policy; and (5) all federal, state, and local statutory claims, including claims for discrimination, harassment, retaliation, attorneys' fees, or other claims arising under the federal Civil Rights Act of 1964 (as amended), the federal Americans with Disabilities Act of 1990, the federal Age Discrimination in Employment Act of 1967 (as amended) ("**ADEA**"), the federal Executive Retirement Income Security Act of 1974 (as amended), and the California Fair Employment and Housing Act (as amended). Notwithstanding the foregoing, the following are not included in the Released Claims (the "**Excluded Claims**"): (1) any rights or claims for indemnification I may have pursuant to any written indemnification agreement with the Company to which I am a party, the charter or bylaws of the Company, or under applicable law; or (2) any rights which are not waivable as a matter of law. In addition, nothing in this Release prevents me from filing, cooperating with, or participating in any proceeding before the Equal Employment Opportunity Commission, the Department of Labor, the California Department of Fair Employment and Housing, or any other local, state, or federal administrative body or government agency that is authorized to enforce or administer laws related to employment, against the Company, except that I hereby waive my right to any monetary benefits in connection with any such claim, charge or proceeding. I hereby represent

and warrant that, other than the Excluded Claims, I am not aware of any claims I have or might have against any of the Released Parties that are not included in the Released Claims.

I acknowledge that I am knowingly and voluntarily waiving and releasing any rights I may have under the ADEA. I also acknowledge that the consideration given for the Released Claims is in addition to anything of value to which I was already entitled. I further acknowledge that I have been advised by this writing, as required by the ADEA, that: (a) the Released Claims do not apply to any rights or claims that arise after the date I sign this Release; (b) I should consult with an attorney prior to signing this Release (although I may choose voluntarily not to do so); (c) I have twenty-one (21) days to consider this Release (although I may choose to voluntarily sign it sooner); (d) I have seven (7) days following the date I sign this Release to revoke the Release by providing written notice to an officer of the Company; and (e) the Release will not be effective until the date upon which the revocation period has expired unexercised, which will be the eighth day after I sign this Release ("**Effective Date**").

I acknowledge that I have read and understand Section 1542 of the California Civil Code which reads as follows: "**A general release does not extend to claims which the creditor does not know or suspect to exist in his or her favor at the time of executing the release, which if known by him or her must have materially affected his or her settlement with the debtor.**" I hereby expressly waive and relinquish all rights and benefits under that section and any law of any jurisdiction of similar effect with respect to my release of any claims hereunder.

I hereby represent that I have been paid all compensation owed and for all hours worked, I have received all the leave and leave benefits and protections for which I am eligible, and I have not suffered any on-the-job injury for which I have not already filed a workers' compensation claim.

I hereby agree not to disparage the Company, or its officers, directors, Executives, shareholders or agents, in any manner likely to be harmful to its or their business, business reputation, or personal reputation; *provided, however*, that I will respond accurately and fully to any question, inquiry or request for information when required by legal process.

I acknowledge that to become effective, I must sign and return this Release to the Company so that it is received not later than twenty-one (21) days following the date it is provided to me, and I must not revoke it thereafter.

BILL ROSSI

Date: _____

ENPHASE ENERGY, INC.

CHANGE IN CONTROL AND SEVERANCE AGREEMENT

This Change in Control and Severance Agreement (the “**Agreement**”) is dated as of June 14, 2011, by and between Dennis Hollenbeck (“**Executive**”) and Enphase Energy, Inc., a Delaware corporation (the “**Company**”). This Agreement is intended to provide Executive with certain benefits described herein upon the occurrence of specific events.

RECITALS

A. It is expected that another company may from time to time consider the possibility of acquiring the Company or that a Change in Control may otherwise occur, with or without the approval of the Company’s Board of Directors (the “**Board**”). The Board recognizes that such consideration can be a distraction to Executive and can cause Executive to consider alternative employment opportunities. The Board has determined that it is in the best interests of the Company and its stockholders to assure that the Company will have the continued dedication and objectivity of the Executive, notwithstanding the possibility, threat or occurrence of a Change in Control (as defined below) of the Company.

B. The Company’s Board believes it is in the best interests of the Company and its shareholders to retain Executive and provide incentives to Executive to continue in the service of the Company.

C. The Board further believes that it is imperative to provide Executive with certain benefits upon termination of Executive’s employment in connection with a Change in Control, which benefits are intended to provide Executive with financial security and provide sufficient income and encouragement to Executive to remain with the Company, notwithstanding the possibility of a Change in Control.

D. To accomplish the foregoing objectives, the Board has directed the Company, upon execution of this Agreement by Executive, to agree to the terms provided in this Agreement.

Now therefore, in consideration of the mutual promises, covenants and agreements contained herein, and in consideration of the continuing employment of Executive by the Company, the parties hereto agree as follows:

1. At-Will Employment. Executive’s employment is at-will, which means that the Company may terminate Executive’s employment at any time, with or without advance notice, and with or without Cause. Similarly, Executive may resign Executive’s employment at any time, with or without advance notice or Good Reason. Executive shall not receive any compensation of any kind, including, without limitation, equity award vesting acceleration and severance benefits, following Executive’s last day of employment with the Company, except as expressly provided herein. Executive shall devote all reasonable efforts to the performance of Executive’s duties, and shall perform such duties in good faith.

2. Benefits Upon Termination of Employment.

(a) **Termination in connection with or following a Change in Control.** If Executive's employment is terminated without Cause (and other than as a result of Executive's death or disability) or Executive resigns for Good Reason, in either case in connection with or within twenty four (24) months after a Change in Control, and provided such termination constitutes a "separation from service" (within the meaning of Treasury Regulation Section 1.409A-1(h), a "**Separation from Service**"), and provided Executive signs and allows to become effective a release substantially in the form attached hereto as **EXHIBIT A** or **EXHIBIT B**, as applicable (the "**Release**") within the time period provided therein, then the Company shall provide Executive with the following severance benefits (the "**Separation Benefits**"):

(i) The Company shall pay Executive an amount equal to three (3) months of Executive's then current base salary, ignoring any decrease in base salary that forms the basis for Good Reason, less all applicable withholdings and deductions, paid over such 3-month period (the "**Salary Continuation**"). The Salary Continuation will be paid in equal installments on the Company's regular payroll schedule and will be subject to applicable tax withholdings over the period outlined above following the date of Executive's Separation from Service as set forth in Section 3 below.

(ii) Should Executive elect to continue his health insurance benefits pursuant to the Consolidated Omnibus Budget Reconciliation Act of 1985 ("**COBRA**") and any analogous provisions of applicable state law, the Company shall pay Executive's COBRA group health insurance premiums for Executive and his eligible dependents for a period of three (3) months following the effective date of such termination of employment described in Section 2(a) (the "**COBRA Payment Period**"). References to COBRA premiums shall not include any amounts payable by Executive under an Internal Revenue Code Section 125 health care reimbursement plan. Notwithstanding the foregoing, if the Company determines, in its sole discretion, that the Company cannot provide the COBRA premium benefits without potentially incurring financial costs or penalties under applicable law (including, without limitation, Section 2716 of the Public Health Service Act), the Company shall in lieu thereof pay Executive a taxable cash amount, which payment shall be made regardless of whether Executive or Executive's eligible family members elect health care continuation coverage (the "**Health Care Benefit Payment**"). The Health Care Benefit Payment shall be paid in monthly installments on the same schedule that the COBRA Premiums would otherwise have been paid to the insurer. The Health Care Benefit Payment shall be equal to the amount that the Company would have otherwise paid for COBRA insurance premiums (which amount shall be calculated based on the premium for the first month of coverage), and shall be paid until the expiration of the COBRA Payment Period.

(iii) The vesting and/or exercisability of any outstanding equity awards held by Executive at the time of Executive's Separation from Service shall be accelerated as to 100% of the then unvested portions of such outstanding equity awards as of the date of Executive's Separation from Service.

3. Limitations And Conditions On Separation Benefits

(a) Release Prior to Payment of Benefits. Prior to the payment of any of the Separation Benefits, Executive shall execute, and allow to become effective, the Release within the time frame set forth therein, but not later than sixty (60) days following Executive's Separation from Service (the "**Release Effective Date**"). Such Release shall specifically relate to all of Executive's rights and claims in existence at the time of such execution and shall confirm Executive's continuing obligations to the Company (including but not limited to obligations under any confidentiality and/or non-solicitation agreement with the Company). No Separation Benefits will be paid prior to the Release Effective Date. Within five (5) days following the Release Effective Date, the Company will pay Executive the Separation Benefits Executive would otherwise have received on or prior to such date but for the delay in payment related to the effectiveness of the Release, with the balance of the benefits being paid as originally scheduled. Unless a Change in Control has occurred, the Board, in its sole discretion, may modify the form of the required Release to comply with applicable law and shall determine the form of the required Release, which may be incorporated into a termination agreement or other agreement with Executive. Notwithstanding the foregoing, if the Company (or, if applicable, the successor entity thereto) determines that any of the Separation Benefits constitute "deferred compensation" under Section 409A (defined below), then, solely to the extent necessary to avoid the incurrence of the adverse personal tax consequences under Section 409A, no Separation Benefits will be paid prior to the sixtieth (60th) day following Executive's Separation from Service. On the sixtieth (60th) day following the date of Separation from Service, the Company will pay to Executive in a lump sum the applicable Separation Benefits that Employee would otherwise have received on or prior to such date, with the balance of the Separation Benefits being paid as originally scheduled.

(b) Income and Employment Taxes. Executives agrees that Executive shall be responsible for any applicable taxes of any nature (including any penalties or interest that may apply to such taxes) that the Company reasonably determines apply to any payment made hereunder, that Executive's receipt of any benefit hereunder is conditioned on Executive's satisfaction of any applicable withholding or similar obligations that apply to such benefit, and that any cash payment owed hereunder will be reduced to satisfy any such withholding or similar obligations that may apply.

(c) Compliance with Section 409A. It is intended that each installment of the payments and benefits provided for in this Agreement is a separate "payment" for purposes of Treasury Regulation Section 1.409A-2(b)(2)(i). For the avoidance of doubt, it is intended that payments of the amounts set forth in this Agreement satisfy, to the greatest extent possible, the exemptions from the application of Section 409A of the Internal Revenue Code of 1986, as amended (the "**Code**") (Section 409A of the Code, together, with any state law of similar effect, "**Section 409A**") provided under Treasury Regulations 1.409A-1(b)(4), 1.409A-1(b)(5) and 1.409A-1(b)(9). However, if the Company (or, if applicable, the successor entity thereto) determines that the severance payments and benefits provided under this Agreement (the "**Agreement Payments**") constitute "deferred compensation" under Section 409A and Executive is, on the date of his Separation from Service, a "specified Executive" of the Company or any successor entity thereto, as such term is defined in Section 409A(a)(2)(B)(i) of the Code (a "**Specified Executive**"), then, solely to the extent necessary to avoid the incurrence of the adverse personal tax consequences under Section 409A, the timing of the Separation Benefit

described in Section 2(a)(i) shall be delayed as follows: on the earlier to occur of (i) the date that is six months and one day after Executive's Separation from Service or (ii) the date of Executive's death (such earlier date, the "**Delayed Initial Payment Date**"), the Company (or the successor entity thereto, as applicable) shall pay to Executive a lump sum amount equal to the applicable benefit that Executive would otherwise have received through the Delayed Initial Payment Date if the commencement of the payment of the benefit had not been so delayed pursuant to this Section 3(c).

(d) Conflicts. Executive represents that his performance of all the terms of this Agreement will not breach any other agreement to which Executive is a party. Executive has not, and will not during the term of this Agreement, enter into any oral or written agreement in conflict with any of the provisions of this Agreement. Executive further represents that Executive is entering into or has entered into an employment relationship with the Company of his own free will and that Executive has not been solicited as an employee in any way by the Company.

(e) Successors. Any successor to the Company (whether direct or indirect and whether by purchase, lease, merger, consolidation, liquidation or otherwise) to all or substantially all of the Company's business and/or assets shall assume the obligations under this Agreement and agree expressly to perform the obligations under this Agreement in the same manner and to the same extent as the Company would be required to perform such obligations in the absence of a succession. The terms of this Agreement and all of Executive's rights hereunder and thereunder shall inure to the benefit of, and be enforceable by, Executive's personal or legal representatives, executors, administrators, successors, heirs, distributees, devisees and legatees.

(f) Notice. Notices and all other communications contemplated by this Agreement shall be in writing and shall be deemed to have been duly given when personally delivered or when mailed by U.S. registered or certified mail, return receipt requested and postage prepaid. Mailed notices to Executive shall be addressed to Executive at the home address which Executive most recently communicated to the Company in writing. In the case of the Company, mailed notices shall be addressed to its corporate headquarters, and all notices shall be directed to the attention of its Chief Financial Officer.

4. Definitions.

(a) Cause. For purposes of this Agreement, "**Cause**", as determined by the Board acting in good faith and based on information then known to it, means: (A) gross negligence or willful misconduct in the performance of duties to the Company where such gross negligence or willful misconduct has resulted or is likely to result in substantial and material damage to the Company or its subsidiaries; (B) a material failure to comply with the Company's written policies after having received from the Company notice of, and a reasonable time to cure, such failure; (C) repeated unexplained or unjustified absence from the Company; (D) conviction of a felony or a crime involving moral turpitude causing material harm to the standing and reputation of the Company; or (E) unauthorized use or disclosure of any proprietary information or trade secrets of the Company or any other party to whom Executive owes an obligation of non-disclosure as a result of Executive's relationship with the Company, which use or disclosure causes or is likely to cause material harm to the Company.

(b) Good Reason. For purposes of this Agreement, “**Good Reason**” for Executive’s resignation of his employment will exist following the occurrence of any of the following without Executive’s written consent: (A) a material reduction or change in job duties, responsibilities or authority inconsistent with Executive’s position with the Company and Executive’s prior duties, responsibilities or authority, provided, however, that any change in Executive’s position after a Change in Control shall not constitute grounds for a termination for Good Reason so long as Executive remains a member of the Company’s senior management (or becomes a member of the senior management of the surviving or acquiring entity) at the same or higher base salary as immediately prior to the Change in Control with equivalent authority and responsibility; (B) a material reduction of Executive’s then current base salary, representing a reduction of more than 10 percent (10%), provided that an across-the-board reduction in the salary level of other executives of the Company by the same percentage amount as part of a general salary level reduction shall not constitute such a material salary reduction; (C) a relocation of the principal place for performance of Executive’s duties to the Company to a location more than forty (40) miles from the Company’s then current location; or (D) any material breach by the Company of this Agreement or Executive’s Employment Agreement (as defined below); provided that Executive gives written notice to the Company of the event forming the basis of the Good Reason resignation within sixty (60) days of the date the Company gives written notice to Executive of its affirmative decision to take an action set forth in (A), (B), (C) or (D) above, the Company fails to cure such basis for the Good Reason resignation within thirty (30) days after receipt of Executive’s written notice and Executive terminates his employment within thirty (30) days following the expiration of the cure period.

(c) Change in Control. For purposes of this Agreement, “**Change in Control**” means the occurrence of any of the following events: (i) any sale or exchange of the capital stock by the shareholders of the Company in one transaction or series of related transactions where more than 50% of the outstanding voting power of the Company is acquired by a person or entity or group of related persons or entities; or (ii) any reorganization, consolidation or merger of the Company where the outstanding voting securities of the Company immediately before the transaction represent or are converted into less than fifty percent 50% of the outstanding voting power of the surviving entity (or its parent corporation) immediately after the transaction; or (iii) the consummation of any transaction or series of related transactions that results in the sale of all or substantially all of the assets of the Company; or (iv) any “person” or “group” (as defined in the Securities Exchange Act of 1934, as amended (the “*Exchange Act*”)) becoming the “beneficial owner” (as defined in Rule 13d-3 under the Exchange Act) directly or indirectly of securities representing more than fifty percent (50%) of the voting power of the Company then outstanding.

5. Parachute Payments.

(a) If any payment or benefit (including payments and benefits pursuant to this Agreement) that Executive would receive in connection with a Change in Control from the Company or otherwise (“**Transaction Payment**”) would (i) constitute a “parachute payment” within the meaning of Section 280G of the Code, and (ii) but for this sentence, be subject to the excise tax imposed by Section 4999 of the Code (the “**Excise Tax**”), then the Company shall cause to be determined, before any amounts of the Transaction Payment are paid to Executive, which of the following two alternative forms of payment would result in Executive’s receipt, on an after-tax basis, of the greater amount of the Transaction Payment notwithstanding that all or

some portion of the Transaction Payment may be subject to the Excise Tax: (1) payment in full of the entire amount of the Transaction Payment (a “**Full Payment**”), or (2) payment of only a part of the Transaction Payment so that Executive receives the largest payment possible without the imposition of the Excise Tax (a “**Reduced Payment**”). For purposes of determining whether to make a Full Payment or a Reduced Payment, the Company shall cause to be taken into account all applicable federal, state and local income and employment taxes and the Excise Tax (all computed at the highest applicable marginal rate, net of the maximum reduction in federal income taxes which could be obtained from a deduction of such state and local taxes). If a Reduced Payment is made, (x) Executive shall have no rights to any additional payments and/or benefits constituting the Transaction Payment, and (y) reduction in payments and/or benefits shall occur in the manner that results in the greatest economic benefit to Executive as determined in this paragraph. If more than one method of reduction will result in the same economic benefit, the portions of the Transaction Payment shall be reduced pro rata.

(b) The professional firm engaged by the Company for general tax purposes as of the day prior to the effective date of the Change in Control shall make all determinations required to be made under this Section 5. If the professional firm so engaged by the Company is serving as accountant or auditor for the individual, entity or group effecting the Change in Control, the Company shall appoint a nationally recognized independent registered public accounting firm to make the determinations required hereunder. The Company shall bear all expenses with respect to the determinations by such professional firm required to be made hereunder.

(c) The professional firm engaged to make the determinations hereunder shall provide its calculations, together with detailed supporting documentation, to the Company and Executive within fifteen (15) calendar days after the date on which Executive’s right to a Transaction Payment is triggered or such other time as reasonably requested by the Company or Executive. If the professional firm determines that no Excise Tax is payable with respect to the Transaction Payment, either before or after the application of the Reduced Amount, it shall furnish the Company and Executive with detailed supporting calculations of its determinations that no Excise Tax will be imposed with respect to such Transaction Payment. Any good faith determinations of the professional firm made hereunder shall be final, binding and conclusive upon the Company and Executive.

6. Other Employment Terms and Conditions. The employment relationship between the parties shall be governed by the general employment policies and procedures of the Company, including those relating to the protection of confidential information and assignment of inventions; provided, however, that when the terms of this Agreement differ from or are in conflict with the Company’s general employment policies or procedures, this Agreement shall control.

7. Miscellaneous Provisions.

(a) **No Duty to Mitigate.** Executive shall not be required to mitigate the amount of any payment contemplated by this Agreement (whether by seeking new employment or in any other manner), nor shall any such payment be reduced by any earnings that Executive may receive from any other source.

(b) Waiver. No provision of this Agreement shall be modified, waived or discharged unless the modification, waiver or discharge is agreed to in writing and signed by Executive and by an authorized officer of the Company (other than Executive). No waiver by either party of any breach of, or of compliance with, any condition or provision of this Agreement by the other party shall be considered a waiver of any other condition or provision or of the same condition or provision at another time.

(c) Whole Agreement. No agreements, representations or understandings (whether oral or written and whether express or implied) which are not expressly set forth in this Agreement have been made or entered into by either party with respect to the subject matter hereof. This Agreement supersedes any agreement (or portion thereof) concerning similar subject matter dated prior to the date of this Agreement, including but not limited to Executive's offer letter with the Company dated December 14, 2010 (the "**Employment Agreement**"), and by execution of this Agreement both parties agree that any such predecessor agreement (or portion thereof) shall be deemed null and void. For the avoidance of doubt, the parties agree that this Agreement does not supersede the provisions of the Employee Agreement that do not address termination or severance benefits, the provisions of any equity plan of the Company that provides for vesting acceleration benefits on the event of a Change in Control in which the successor corporation does not assume or substitute for outstanding equity awards or Executive's Employee Invention Assignment and Confidentiality Agreement with the Company.

(d) Choice of Law. The validity, interpretation, construction and performance of this Agreement shall be governed by the laws of the State of California without reference to conflict of laws provisions.

(e) Severability. If any term or provision of this Agreement or the application thereof to any circumstance shall, in any jurisdiction and to any extent, be invalid or unenforceable, such term or provision shall be ineffective as to such jurisdiction to the extent of such invalidity or unenforceability without invalidating or rendering unenforceable the remaining terms and provisions of this Agreement or the application of such terms and provisions to circumstances other than those as to which it is held invalid or unenforceable, and a suitable and equitable term or provision shall be substituted therefor to carry out, insofar as may be valid and enforceable, the intent and purpose of the invalid or unenforceable term or provision.

(f) Arbitration. Executive and the Company agree to attempt to settle any disputes arising in connection with this Agreement through good faith consultation. In the event that Executive and the Company are not able to resolve any such disputes within fifteen (15) days after notification in writing to the other, Executive and the Company agree that any dispute or claim arising out of or in connection with this Agreement will be finally settled by binding arbitration in Sonoma County, California in accordance with the rules of the American Arbitration Association by one arbitrator mutually agreed upon by the parties. The arbitrator will apply California law, without reference to rules of conflicts of law or rules of statutory arbitration, to the resolution of any dispute. Except as set forth in Subparagraph (e) above, the arbitrator shall not have authority to modify the terms of this Agreement. The Company shall pay the costs of the arbitration proceeding. Each party shall, unless otherwise determined by the arbitrator, bear its or his own attorneys' fees and expenses, provided however that if Executive prevails in an arbitration proceeding, the Company shall reimburse Executive for his reasonable attorneys' fees and costs. Judgment on the award rendered by the arbitrator may be entered in

any court having jurisdiction thereof. Notwithstanding the foregoing, the Company and Executive may apply to any court of competent jurisdiction for preliminary or interim equitable relief, or to compel arbitration in accordance with this paragraph, without breach of this arbitration provision.

(g) Legal Fees and Expenses. The parties shall each bear their own expenses, legal fees and other fees incurred in connection with the execution of this Agreement.

(h) No Assignment of Benefits. The rights of any person to payments or benefits under this Agreement shall not be made subject to option or assignment, either by voluntary or involuntary assignment or by operation of law, including (without limitation) bankruptcy, garnishment, attachment or other creditor's process, and any action in violation of this Section 7(h) shall be void.

(i) Assignment by Company. The Company may assign its rights under this Agreement to an affiliate, and an affiliate may assign its rights under this Agreement to another affiliate of the Company or to the Company. In the case of any such assignment, the term "Company" when used in a section of this Agreement shall mean the corporation that actually employs the Executive.

(j) Counterparts. This Agreement may be executed in counterparts, each of which shall be deemed an original, but all of which together will constitute one and the same instrument.

IN WITNESS WHEREOF, the parties have executed this Agreement as of the date written below.

/s/ Dennis Hollenbeck

DENNIS HOLLENBECK

Address: _____

Date: 6/14/11

ENPHASE ENERGY, INC.

/s/ Paul Nahi

Name: Paul Nahi

Title: Chief Executive Officer

Date: 6/14/11

EXHIBIT A

RELEASE AGREEMENT

I understand and agree completely to the terms set forth in the Enphase Energy, Inc. Change in Control and Severance Agreement (the "**Agreement**").

I understand that this Release, together with the Agreement, constitutes the complete, final and exclusive embodiment of the entire agreement between the Company, affiliates of the Company and me with regard to the subject matter hereof. I am not relying on any promise or representation by the Company that is not expressly stated therein. Certain capitalized terms used in this Release are defined in the Agreement.

I hereby confirm my obligations under my Employee Invention Assignment and Confidentiality Agreement with the Company.

Except as otherwise set forth in this Release, I hereby generally and completely release the Company and its current and former directors, officers, Executives, shareholders, partners, agents, attorneys, predecessors, successors, parent and subsidiary entities, insurers, affiliates, and assigns (collectively, the "**Released Parties**") from any and all claims, liabilities and obligations, both known and unknown, that arise out of or are in any way related to events, acts, conduct, or omissions occurring prior to my signing this Release (collectively, the "**Released Claims**"). The Released Claims include, but are not limited to: (1) all claims arising out of or in any way related to my employment with the Company or its affiliates, or the termination of that employment; (2) all claims related to my compensation or benefits, including salary, bonuses, commissions, vacation pay, expense reimbursements, severance pay, fringe benefits, stock, stock options, or any other ownership interests in the Company or its affiliates; (3) all claims for breach of contract, wrongful termination, and breach of the implied covenant of good faith and fair dealing; (4) all tort claims, including claims for fraud, defamation, emotional distress, and discharge in violation of public policy; and (5) all federal, state, and local statutory claims, including claims for discrimination, harassment, retaliation, attorneys' fees, or other claims arising under the federal Civil Rights Act of 1964 (as amended), the federal Americans with Disabilities Act of 1990, the federal Age Discrimination in Employment Act of 1967 (as amended) ("**ADEA**"), the federal Employee Retirement Income Security Act of 1974 (as amended), and the California Fair Employment and Housing Act (as amended). Notwithstanding the foregoing, the following are not included in the Released Claims (the "**Excluded Claims**"): (1) any rights or claims for indemnification I may have pursuant to any written indemnification agreement with the Company to which I am a party, the charter or bylaws of the Company, or under applicable law; or (2) any rights which are not waivable as a matter of law. In addition, nothing in this Release prevents me from filing, cooperating with, or participating in any proceeding before the Equal Employment Opportunity Commission, the Department of Labor, the California Department of Fair Employment and Housing, or any other local, state, or federal administrative body or government agency that is authorized to enforce or administer laws related to employment, against the Company, except that I hereby waive my right to any monetary benefits in connection with any such claim, charge or proceeding. I hereby represent and warrant that, other than the Excluded Claims, I am not aware of any claims I have or might have against any of the Released Parties that are not included in the Released Claims.

I acknowledge that I am knowingly and voluntarily waiving and releasing any rights I may have under the ADEA. I also acknowledge that the consideration given for the Released Claims is in addition to anything of value to which I was already entitled. I further acknowledge that I have been advised by this writing, as required by the ADEA, that: (a) the Released Claims do not apply to any rights or claims that arise after the date I sign this Release; (b) I should consult with an attorney prior to signing this Release (although I may choose voluntarily not to do so); (c) I have forty-five (45) days to consider this Release (although I may choose to voluntarily sign it sooner); (d) I have seven (7) days following the date I sign this Release to revoke the Release by providing written notice to an officer of the Company; and (e) the Release will not be effective until the date upon which the revocation period has expired unexercised, which will be the eighth day after I sign this Release ("**Effective Date**").

I have received with this Release all of the information required by the ADEA, including without limitation a detailed list of the job titles and ages of all Executives who were terminated in this group termination and the ages of all Executives of the Company in the same job classification or organizational unit who were not terminated, along with information on the eligibility factors used to select Executives for the group termination and any time limits applicable to this group termination program.

I acknowledge that I have read and understand Section 1542 of the California Civil Code which reads as follows: "**A general release does not extend to claims which the creditor does not know or suspect to exist in his or her favor at the time of executing the release, which if known by him or her must have materially affected his or her settlement with the debtor.**" I hereby expressly waive and relinquish all rights and benefits under that section and any law of any jurisdiction of similar effect with respect to my release of any claims hereunder.

I hereby represent that I have been paid all compensation owed and for all hours worked, I have received all the leave and leave benefits and protections for which I am eligible, and I have not suffered any on-the-job injury for which I have not already filed a workers' compensation claim.

I hereby agree not to disparage the Company, or its officers, directors, Executives, shareholders or agents, in any manner likely to be harmful to its or their business, business reputation, or personal reputation; *provided, however*, that I will respond accurately and fully to any question, inquiry or request for information when required by legal process.

I acknowledge that to become effective, I must sign and return this Release to the Company so that it is received not later than forty-five (45) days following the date it is provided to me, and I must not revoke it thereafter.

DENNIS HOLLENBECK

Date: _____

EXHIBIT B
RELEASE AGREEMENT

I understand and agree completely to the terms set forth in the Enphase Energy, Inc. Change in Control and Severance Agreement (the "**Agreement**").

I understand that this Release, together with the Agreement, constitutes the complete, final and exclusive embodiment of the entire agreement between the Company, affiliates of the Company and me with regard to the subject matter hereof. I am not relying on any promise or representation by the Company that is not expressly stated therein. Certain capitalized terms used in this Release are defined in the Agreement.

I hereby confirm my obligations under my Employee Invention Assignment and Confidentiality Agreement with the Company.

Except as otherwise set forth in this Release, I hereby generally and completely release the Company and its current and former directors, officers, Executives, shareholders, partners, agents, attorneys, predecessors, successors, parent and subsidiary entities, insurers, affiliates, and assigns (collectively, the "**Released Parties**") from any and all claims, liabilities and obligations, both known and unknown, that arise out of or are in any way related to events, acts, conduct, or omissions occurring prior to my signing this Release (collectively, the "**Released Claims**"). The Released Claims include, but are not limited to: (1) all claims arising out of or in any way related to my employment with the Company or its affiliates, or the termination of that employment; (2) all claims related to my compensation or benefits, including salary, bonuses, commissions, vacation pay, expense reimbursements, severance pay, fringe benefits, stock, stock options, or any other ownership interests in the Company or its affiliates; (3) all claims for breach of contract, wrongful termination, and breach of the implied covenant of good faith and fair dealing; (4) all tort claims, including claims for fraud, defamation, emotional distress, and discharge in violation of public policy; and (5) all federal, state, and local statutory claims, including claims for discrimination, harassment, retaliation, attorneys' fees, or other claims arising under the federal Civil Rights Act of 1964 (as amended), the federal Americans with Disabilities Act of 1990, the federal Age Discrimination in Employment Act of 1967 (as amended) ("**ADEA**"), the federal Executive Retirement Income Security Act of 1974 (as amended), and the California Fair Employment and Housing Act (as amended). Notwithstanding the foregoing, the following are not included in the Released Claims (the "**Excluded Claims**"): (1) any rights or claims for indemnification I may have pursuant to any written indemnification agreement with the Company to which I am a party, the charter or bylaws of the Company, or under applicable law; or (2) any rights which are not waivable as a matter of law. In addition, nothing in this Release prevents me from filing, cooperating with, or participating in any proceeding before the Equal Employment Opportunity Commission, the Department of Labor, the California Department of Fair Employment and Housing, or any other local, state, or federal administrative body or government agency that is authorized to enforce or administer laws related to employment, against the Company, except that I hereby waive my right to any monetary benefits in connection with any such claim, charge or proceeding. I hereby represent

and warrant that, other than the Excluded Claims, I am not aware of any claims I have or might have against any of the Released Parties that are not included in the Released Claims.

I acknowledge that I am knowingly and voluntarily waiving and releasing any rights I may have under the ADEA. I also acknowledge that the consideration given for the Released Claims is in addition to anything of value to which I was already entitled. I further acknowledge that I have been advised by this writing, as required by the ADEA, that: (a) the Released Claims do not apply to any rights or claims that arise after the date I sign this Release; (b) I should consult with an attorney prior to signing this Release (although I may choose voluntarily not to do so); (c) I have twenty-one (21) days to consider this Release (although I may choose to voluntarily sign it sooner); (d) I have seven (7) days following the date I sign this Release to revoke the Release by providing written notice to an officer of the Company; and (e) the Release will not be effective until the date upon which the revocation period has expired unexercised, which will be the eighth day after I sign this Release ("**Effective Date**").

I acknowledge that I have read and understand Section 1542 of the California Civil Code which reads as follows: "**A general release does not extend to claims which the creditor does not know or suspect to exist in his or her favor at the time of executing the release, which if known by him or her must have materially affected his or her settlement with the debtor.**" I hereby expressly waive and relinquish all rights and benefits under that section and any law of any jurisdiction of similar effect with respect to my release of any claims hereunder.

I hereby represent that I have been paid all compensation owed and for all hours worked, I have received all the leave and leave benefits and protections for which I am eligible, and I have not suffered any on-the-job injury for which I have not already filed a workers' compensation claim.

I hereby agree not to disparage the Company, or its officers, directors, Executives, shareholders or agents, in any manner likely to be harmful to its or their business, business reputation, or personal reputation; *provided, however*, that I will respond accurately and fully to any question, inquiry or request for information when required by legal process.

I acknowledge that to become effective, I must sign and return this Release to the Company so that it is received not later than twenty-one (21) days following the date it is provided to me, and I must not revoke it thereafter.

DENNIS HOLLENBECK

Date: _____

CONSENT OF INDEPENDENT REGISTERED PUBLIC ACCOUNTING FIRM

We consent to the use in this Amendment No. 1 to Registration Statement No. 333-174925 on Form S-1 of our report dated April 29, 2011 (June 15, 2011 as to Note 15) relating to the consolidated financial statements of Enphase Energy, Inc. appearing in the Prospectus, which is part of this Registration Statement.

We also consent to the reference to us under the heading "Experts" in such Prospectus.

/s/ DELOITTE & TOUCHE LLP
San Francisco, California
July 22, 2011



John H. Sellers
(650) 843-5070
jsellers@cooley.com

VIA EDGAR AND OVERNIGHT DELIVERY

July 25, 2011

Securities and Exchange Commission
Division of Corporation Finance
100 F Street, N.E.
Washington, D.C. 20249
Attn: Russell Mancuso
Ruairi Regan

**RE: Enphase Energy, Inc.
Amendment No. 1 to Registration Statement on Form S-1
Filed July 22, 2011
File No. 333-174925**

Ladies and Gentlemen:

On behalf of Enphase Energy, Inc. (the "**Company**" or "**Enphase**"), we are transmitting for filing Amendment No. 1 (the "**Amendment**") to the Registration Statement on Form S-1, File No. 333-174925 (the "**Registration Statement**"). We are sending a copy of this letter, the Amendment and certain supplemental materials in the traditional non-EDGAR format, including a version that is marked to show changes to the Registration Statement filed with the U.S. Securities and Exchange Commission (the "**Commission**") on June 15, 2011, and will forward a courtesy package of these documents for the staff of the Commission (the "**Staff**"), in care of Mr. Ruairi Regan.

The Amendment is being filed in response to comments received from the Staff, by letter dated July 12, 2011, with respect to the Registration Statement (the "**Comments**"). The numbering of the paragraphs below corresponds to the numbering of the Comments, which, for the Staff's convenience, have been incorporated into this response letter. Page references in the text of this response letter correspond to the page numbers of the Amendment.

Inside Cover Page

1. *Please revise your graphics as follows:*

- *If significant text, technical terms or jargon like you have included is necessary to understand graphics, the presentation generally is inappropriate for the prospectus cover. If you elect to include graphics, please revise so that they do not require the current lengthy text, jargon or technical explanations. Likewise, revise the inside back cover of the prospectus to eliminate the jargon that may be appropriate to market your product but not for a securities offering disclosure document.*

FIVE PALO ALTO SQUARE, 3000 EL CAMINO REAL, PALO ALTO, CA 94306-2155 T: (650) 843-5000 F: (650) 849-7400 WWW.COOLEY.COM

- *From the first full-page graphic and the picture of the house on the following page, it appears that you sell solar panels. If this is not true, please revise to remove any implication to the contrary.*

In response to the Staff's comment, the Company has revised the inside cover and inside back cover of the prospectus to simplify the language and to remove any implication that the Company is selling solar panels instead of its microinverters.

Table of Contents

2. *Please tell us how you believe the last sentence of the second paragraph following your table of contents is consistent with Section 12(a)(2) of the Securities Act.*

The Company appreciates the Staff's comment. The Company submits that the referenced sentence is intended to make a factual statement that the information contained in the prospectus can only be accurate as of its date. The sentence is not intended to attempt to limit any liability under Section 12(a)(2) of the Securities Act of 1933, as amended (the "**Securities Act**"). Consistent with Section 12(a)(2), if prior to completion of the offering any of the statements in the prospectus become untrue in a manner that implicates the materiality standard of Section 12(a)(2), the Company intends to inform prospective investors of such event through a prospectus supplement or other means permitted by the Securities Act.

Prospectus Summary, page 1

3. *It is unclear whether all of the information regarding your solutions, strengths and strategies is appropriate for a prospectus summary; see Updated Staff Legal Bulletin No. 7 (June 7, 1999) sample comments 28 and 29. If the disclosure is appropriate for a summary, please explain to us why and ensure that you provide equally prominent disclosure of negative elements of this offering and your business. We note that you present separately captioned and explained bullet points regarding your strengths and strategy but provide only brief bullet points regarding your challenges on page 5. Also, if your system requires a higher initial investment than competitive systems, has a limited market due to its wattage, has lower conversion efficiencies than competitive products, or faces competition from significant new entrants into the market producing products like yours, please highlight these issues clearly and directly. In this regard, we note that the bullet point on page 6 merely suggests that you are expecting additional competition generally and that you are not aware of any actual specific significant new competitive threats.*

In response to the Staff's comment, the Company has revised its prospectus summary to further condense its summary of its solutions, strengths and strategies and to provide a more balanced disclosure of its challenges on page 5 of the Amendment.

Enphase Energy, Inc., page 1

4. *Please provide us independent, objective support for your claim that your technology is fundamentally new in the first sentence. Also, provide us such support for the following statements that you make:*
- *your product is “industry leading,” in the first bullet on page 3 and on page 66;*
 - *your claim regarding greater system uptime on page 3;*
 - *your claim of industry leading reliability on page 4;*
 - *that you were first to market, in the third bullet, on page 4. Address how you concluded that other companies did not market microinverters in the past;*
 - *you are the “leading supplier of microinverters,” on page 5.*
 - *SunWize Technologies, Inc., Focused Energy LLC, SolarNet Holdings, LLC, Conergy AG and AEE Solar Inc. are among the largest solar distributors, on page 79; and*
 - *Wesco and GexPro are some of the largest electrical contractor distributors in North America, on page 79.*

The Company respectfully advises the Staff that its microinverter system is a fundamentally new technology for the solar industry because of its system design, which combines power electronics, purpose-built semiconductor content and proprietary communications technology. This differentiates the Company’s system from traditional central inverter products. While other companies tried the single inverter per module approach, prior to Enphase’s successful commercialization, none of them successfully incorporated significant purpose-built semiconductor content or included communications technology in their products.

With regard to the statement that the Company’s product is “industry leading” and that the Company is the “leading supplier of microinverters,” the Company advises the Staff that its statements are based on the IMS Research data, which is provided supplementally to the Staff. Based on the IMS Research data, in 2010, Enphase had 10.6% of total North America inverter revenue (including both central and microinverter revenue). Only SMA Solar Technology AG, Advanced Energy Industries, Inc. and Satcon Technology Corporation had a greater share of total North America inverter revenue. Based on the Company’s review of publicly available information, the Company believes that none of these companies offers a microinverter product, supporting the claim that Enphase is the leading microinverter technology vendor.

In connection with the Company’s statement regarding greater system uptime, the Company advises the Staff that it removed the references to the “greater” system uptime from pages 3 and 67 of the Amendment. With regard to the Company’s statements regarding system uptime, the Company advises the Staff that “system uptime” accounts for times when a solar PV system is not functioning due to failure or maintenance. Traditional central inverters fail more frequently than Enphase microinverters, and when they fail it results in lost energy production from the entire array. Field data collected by Westinghouse over a period of two years, which the Company provides supplementally to the Staff, indicates a per unit failure rate of 0.207% for microinverters deployed in residential solar PV systems versus a per unit failure rate of 9.43% for traditional central inverters deployed in residential solar PV systems. The lower failure rate per unit, combined with the distributed architecture of the Enphase microinverter system (which allows the overall PV system to keep functioning even if a single unit fails), produces greater system uptime versus solar PV systems deploying traditional central inverters, which act as a single point of failure for the system. In addition to the improved uptime on a per unit basis, the Company advises the Staff that the Westinghouse data suggests that microinverters achieve greater uptime than traditional central inverters on an hourly basis, 99.998% versus 99.952%.

With respect to the statement related to industry leading reliability, the Company advises the Staff that it based its statement on the failure rate data from Westinghouse, which showed Enphase microinverters being 45 times more reliable than central inverters.

With respect to the statement that the Company was first to market, the Company advises the Staff that it believes that it was the first company to successfully market microinverter technology for application in solar PV systems based on its significant commercial success. While other companies have tried a single inverter per module approach, to the Company's knowledge, no other company shipped microinverter technology for solar applications in volume prior to the Company's product success. For example, the Dutch company OKE-Services marketed a microinverter product for solar applications but was bought by SMA Solar Technology AG, a manufacturer of photovoltaic inverters and monitoring systems (SMA) in 2009, and to date SMA has yet to release a microinverter product or begin to market OKE's original product. Similarly, Ascension Technology was purchased by Applied Power Corporation which in turn was purchased by SCHOTT AG in 2002 which then ceased to offer Ascension Technology's microinverter solution in favor of SCHOTT's existing traditional inverter designs. Another example of earlier failures of microinverter solutions can be found in NKF Kabel B.V., which ended production of its microinverter product, or OK4 series, in 2003 when a subsidy program ended. In contrast, Enphase has shipped its microinverter commercially since mid-2008, and has sold more than 750,000 units through May 31, 2011. Based on the foregoing, the Company believes that Enphase is the first company to successfully market microinverter technology for solar applications.

In addition, in response to the Staff's comment, the Company has revised its disclosure on page 79 of the Amendment to delete the reference to the size of the distributors listed there.

5. *Please provide us with copies of reports of Westinghouse Solar where it makes the statements that you cite in the summary. Clearly mark the supporting statements in the supplemental materials.*

The Company supplementally provides to the Staff the data supplied to the Company by Westinghouse Solar that shows a failure rate by traditional central inverters of 9.43% and an Enphase microinverter failure rate of 0.207%, collected by Westinghouse over a period of two years. This demonstrates an Enphase microinverter failure rate that is 45 times less than that of a traditional inverter.

6. *Please tell us whether the chart of "Market Share Evolution" reflects your typical market share. If it is not typical, it is unclear why you believe it is appropriate to highlight it in your prospectus summary. Likewise, where you repeat this data elsewhere in your document, please ensure that you present sufficient context so that investors can evaluate the extent to which it reflects your typical market share.*

The Company supplementally advises the Staff that it believes the "Market Share Evolution" chart is representative of its typical market share because the California market represents the largest single solar market in the U.S., with 30% of all solar installations in the U.S. in 2010, as estimated by the Solar Energy Industries Association (SEIA).

The Company believes that market trends in the California market, the largest solar market in the U.S., are indicative of its expectations for other North American markets. In response to the Staff's comment, the Company has clearly labeled the chart as representing the "California Residential Market Share."

Our Solution, page 3

7. *Please highlight in your prospectus summary your statement on page 54 regarding your insignificant revenue from the web-based monitoring service. Also, if you sell any of the three components separately and those separate sales represent a material portion of your revenue, please highlight that fact here. In an appropriate section of your document, provide the three-year revenue history by product class required by Regulation S-K Item 101(c)(1)(i).*

In response to the Staff's comment, the Company has provided additional disclosure on page 3 of the prospectus summary.

The Company further advises the Staff that while the Company sells its microinverters and communications gateway devices separately, the Company considers these products to be of a single class of product (hardware). Since inception 99% of the Company's net revenues have been derived from the sale of hardware products. In addition, the Company advises the Staff that revenues from the sale of Envoy communications gateway devices (which are part of the hardware product class) represented 9%, 7%, 6% and 6% of total net revenues for 2008, 2009, 2010 and the three months ended March 31, 2011, respectively, and are not expected to increase as a percentage of total net revenues in the future. Therefore, consistent with Regulation S-K Item 101(c)(1)(i), the Company advises the Staff that it does not believe it is required to include any further revenue history by product class.

The Offering, page 7

8. *Please update the disclosure in the bullet points in this section. We note for example the updated information on page 122 and in the penultimate paragraph on page 105.*

In response to the Staff's comment, the Company has revised its disclosure in the Offering section to update the relevant capitalization numbers through June 30, 2011. With respect to the capitalization table on page 34 of the Amendment that relates to the Company's financial statements as of March 31, 2011, the Company advises the Staff that it will update that disclosure in connection with providing the financial results for the second quarter ended June 30, 2011 with its next amendment to the Registration Statement. The Company has provided updated information through June 30, 2011 in the bullet points in this section.

9. *Refer to the last sentence on page 8. Please tell us why you believe it is appropriate to not reflect the effect a split that apparently will occur before investors become owners of your shares.*

The Company acknowledges the Staff's comment and respectfully advises the Staff that the effect of the expected reverse stock split will be reflected in a future amendment to the Registration Statement once the size of the split becomes finalized and approved by the Company's board of directors. The Company intends to finalize and disclose the split prior to printing its preliminary prospectus.

Risk Factors, page 11

10. *In an appropriate risk factor, please describe recent trends experienced by participants in the solar industry.*

In response to the Staff's comment, the Company has provided additional disclosure to describe recent trends experienced by participants in the solar industry on pages 11 and 12 of the Amendment.

If our contract manufacturers are unable to obtain raw materials, page 19

11. *Please describe recent cycles in the availability of silicon. Also, if you will compete with solar panel manufacturers for silicon in times of shortage, please describe this risk.*

The Company respectfully advises the Staff that neither the Company nor its contract manufacturers rely on silicon other than small amounts for its semiconductor chip. Any potential changes in the manufacturing cost of its semiconductor chip due to changes in the price of semiconductor-grade silicon would be minimal and although the Company mentions it in the respective risk factor on page 18, the Company does not feel that it requires further disclosure. The Company does not design, sell or market solar-grade silicon solar modules or any other silicon-based products.

If we fail to maintain an effective system of internal controls..., page 23

12. *Please describe the identified significant deficiencies you mention here.*

In response to the Staff's comment, the Company has revised and expanded the risk factor on page 23 of the Amendment.

Use of Proceeds, page 33

13. *Given that you appear to have no specific plan for the proceeds, please discuss the principal reasons for the offering of this size.*

In response to the Staff's comment, the Company has provided additional disclosure on page 32 of the Amendment. In addition, the Company advises the Staff that it currently does not have any estimates with respect to the specific allocation of the proceeds from this offering.

14. *We note your disclosure that you currently have no agreements or commitments relating to any material acquisitions. Please tell us if you are currently involved in any negotiations regarding material acquisitions and the status of such negotiations.*

The Company respectfully advises the Staff that it is currently not involved in any negotiations regarding material acquisitions.

15. *Although we note your statement that you have no commitment or specific plans to repay debt, Regulation S-K Item 504 requires you to disclose your current intentions regarding the use of the proceeds; see instruction 7 to Item 504. Please revise accordingly, and provide the disclosure required by instruction 4 to Regulation S-K Item 504. Also, with a view toward disclosure, please tell us whether you currently intend to use proceeds for:*
- *the move to the new headquarters mentioned on page 53;*
 - *the expansion into China mentioned on page 72; or*
 - *to repay the debt under your June 14, 2011 convertible facility, which appears, based on your disclosure in the last paragraph on page 51, to mature upon the closing of your initial public offering.*

In response to the Staff's comment, the disclosure on page 32 of the Amendment has been revised to provide more detail regarding the Company's plans for the proceeds. The Company further advises the Staff that it does not believe that the debt under its June 14, 2011 convertible facility would be repaid upon the closing of this offering but the investors would elect to instead convert their notes into the shares of the Company's common stock, since the conversion feature provides for the debt to convert at \$0.98 per share, subject to adjustment for the anticipated reverse stock split referenced in the Registration Statement. To the extent any noteholder under this convertible facility elects not to convert its note into common stock, the Company intends to use existing cash to repay such debt.

Capitalization, page 35

16. *Please revise to remove the caption relating to cash and cash equivalents from your presentation of capitalization, since this item is not a component of capitalization for purposes of this disclosure.*

In response to the Staff's comment, the Company has removed the caption relating to cash and cash equivalents from the presentation of capitalization on page 34 of the Amendment.

Dilution, page 37

17. *Please provide your computations of net tangible book value and pro forma net tangible book value at the end of the fiscal year and interim period.*

In response to the Staff's comment, the Company has provided a more detailed disclosure of the computations as of March 31, 2011 on page 36 of the Amendment and will update such disclosures in future filings. The Company respectfully advises the Staff that it

believes the presentation of net tangible book value and pro forma net tangible book value as of the most recent interim period complies with Regulation S-K Item 506 and inclusion of such amounts as of the most recent fiscal year end is not required.

Results of Operations, page 42

18. *Your explanations for the increase in general and administrative expenses do not appear to explain the entire change. Please explain the balance of the increase.*

In response to the Staff's comment, the Company has revised its disclosure on pages 44 and 46-47 of the Amendment.

19. *Where you attribute changes to multiple causes, like in your discussion of cost of revenues on page 44, please quantify the effect of each material cause.*

In response to the Staff's comment, where changes in results of operations are attributed to multiple causes, the Company has revised its disclosures to quantify the effect of each material cause described on pages 43-47 of the Amendment.

20. *Please tell us why you do not discuss the impact that the increased cost of your 2011 leases will have on your results of operations.*

The Company has revised the disclosure to include a discussion of the expected impact of its new lease obligation on its future results of operations on pages 42 and 52 of the Amendment in response to the Staff's comment.

Net Revenues, pages 44 and 46

21. *Please revise to explain the reason for the decline in average selling price of your microinverter units discussed on pages 44 and 46.*

In response to the Staff's comment, the Company has updated its disclosure on pages 43 and 45 of the Amendment.

Debt Obligations, page 51

22. *Given your previously existing resources, please clarify the purposes for the additional debt you incurred.*

The Company respectfully advises the Staff that the Company believes it is prudent to obtain access to additional funding given that the capital markets have experienced volatility in recent years and there is no assurance that funding through an initial public offering will be available when needed. Conditions in the capital markets could change, potentially delaying our public offering. The Company believes additional available funding from these debt facilities helps provide the flexibility to help withstand these types of conditions.

23. *Given your second risk factor on page 23, please discuss the material debt covenants to which you are subject under your existing loan agreements.*

In response to the Staff's comment, the Company has updated its disclosures in the Management's Discussion and Analysis discussion of its Debt Obligations on pages 50 and 51 of the Amendment and in the footnotes to the consolidated financial statements on pages F-24 of the Amendment to include additional information regarding the material debt covenants under the Company's loan agreements.

Critical Accounting Policies and Significant Estimates

Revenue Recognition, page 54

24. *Please revise to disclose the sales incentives, rebates and discounts offered to customers and distributors, how these incentives, rebates and discounts are estimated and the related accounting treatment.*

The Company has revised its disclosure on page 53 of the Amendment in response to the Staff's comment.

Product Warranty, page 54 Warranty Obligations, page F-9

25. *Please revise to clarify how you determined the estimated accrual for claims under your 15-year and 25-year limited product warranties each period, considering your limited operating history and the fact that this is new technology in the solar industry. Please clarify whether this accrual is based on a percentage of revenue and, if so, how that percentage was determined each period. Please disclose your assumptions regarding estimated failure rates and replacement costs and how these were determined. We also note your reference on page 67 that you provide a "100% system uptime guarantee." Please disclose the nature of this guarantee and clarify how you have estimated your warranty accrual related to this guarantee.*

In response to the Staff's comment, the Company has revised its disclosures on page 54 of the Amendment and pages F-9 and F-10 of the notes to consolidated financial statements to further clarify how its estimated accrual for warranty claims was determined for each period. The Company further advises the Staff that its accrual is not based on a percentage of revenue, but rather on a per unit basis.

The Company further advises the Staff that it provides system owners with a 100% uptime guarantee under its Entrust program, whereby the Company reimburses the system owner for any lost energy for a solar panel for up to one month if a microinverter unit should fail. The Company estimates that its microinverter systems achieve system uptimes of at least 99.8%. The Company has not experienced significant claims or disbursements under this program to date and does not expect to incur significant costs to fulfill its obligations under this program in the future, and therefore no accrual has been recorded for any such future obligations.

Stock-Based Compensation, pages 55 to 59 Note 10. Stock Based Compensation, pages F-19 to F-21

26. *We reference the disclosure on page 55 of the many factors your board of directors, with input from management, considered to determine the fair value of your common stock. We also see on pages 57 through 59 that you subsequently determined that a stock compensation charge should be calculated for the difference between the exercise price at the grant date and the estimated fair value at the grant date, based on an independent valuation report as of January 31, 2011. Please tell us the extent of your reliance on this independent valuation report for the updated estimated fair value of your stock and key assumptions disclosed on pages 57 through 59.*

The Company respectfully advises the Staff that it is responsible for, and provided the independent valuation firm with, all the underlying financial information, including its historical, current and expected future operating performance, financial condition, business milestones and risks, etc. The Company relied, in part, on the work of the independent valuation firm, but only as to the extent of their financial valuation expertise (e.g. determination of the discount rate, lack of marketability, etc.). The Company assumed full responsibility for the inputs provided, and ultimately the Company determined the updated estimated fair value at grant date. In response to the Staff's comment, the Company has added disclosures regarding its consideration of the January 2011 estimated updated fair value on pages 57-59 of the Amendment and clarified that that the Company relied in part on such independent valuation report.

27. *Please revise to disclose the significant assumptions used to determine the estimated fair value of the common shares utilized for stock compensation purposes in fiscal 2010 and 2011 under the income and market approaches and the basis for these assumptions. For example, revise to clarify how you considered lack of marketability of your common stock associated with private company status and how you determined the related discounts each period. In addition, highlight any transactions with unrelated parties believed by management to be particularly evident of an objective fair value per share determination. Please clarify how the issuances of preferred stock were considered in the fair values per share at grant date disclosed on page 56.*

In response to the Staff's comment, the Company has added disclosure on significant events and assumptions regarding the basis for the determination of its lack of marketability discounts and our consideration of the preferred stock issuances on pages 57-60 of the Amendment. The Company further advises the Staff that its consideration of the issuances of Series E convertible preferred stock is disclosed with respect to the November 2010 grant referred to on page 58 and the July 2010 and June 2010 grants described on pages 58-59 of the Amendment; and its consideration of the issuance of Series D convertible preferred stock is disclosed with respect to the January 2010 grant on pages 59-60 of the Amendment. There were no other transactions with unrelated parties believed to be particularly evident of an objective fair value per share determination.

July 25, 2011
Page Eleven

28. *Please indicate when discussions were initiated with your underwriter(s) about possible offering price ranges and provide us a history of those discussions. Please provide us with a chronological bridge of management's fair value per share determinations to the current estimated IPO price per share. We will delay final assessment of stock based compensation pending inclusion of the estimated IPO price in the filing.*

The Company advises the Staff that in March 2011 it issued requests for proposals to potential underwriters for this offering, requesting proposal submissions by mid-April 2011. The Company received proposals and met with investment banks in mid-April 2011. At that time, each of the underwriters provided the Company with its analysis of the Company's business, a summary of how the underwriter would position the Company for an offering, and valuation methodologies and analyses of comparable companies, but the underwriters did not provide the Company with any valuation of the Company or a possible offering price range.

The Company further advises the Staff that although it selected the underwriters for this offering in late-April 2011, none of the investment banks interviewed offered any indications of value, and there remained substantial uncertainty over the Company's ability to complete an offering in light of market conditions. In early May 2011, the Company held its organizational meeting with its underwriters. The initial meetings with the underwriters focused on providing an overview of the Company's business, discussing the offering process and drafting disclosure.

The Company has not held discussions with the underwriters regarding the possible price range for the initial public offering through the date of this letter.

The Company understands that the Staff will delay final assessment of stock based compensation pending inclusion of the estimated IPO price range in the filing.

Business, page 61

29. *Please provide support for the figures presented in the tables on pages 69 and 70. Tell us:*
- *how you determined that the data presented in the tables is fairly representative of all installations;*
 - *whether each installation presented actually uses your product and is achieving the results disclosed;*

- *whether competitors other than providers of traditional central inverters could achieve the same or better results; and*
- *why you have not identified the installer named as a source and provided its consent as an exhibit.*

Also, explain the term energy harvest.

The Company advises the Staff that the two case studies presented on pages 69 and 70 represent actual residential and commercial installations deploying Enphase microinverter systems. For each installation, the installer provided the Company with the location, size of installation and number and cost of solar modules used, as well as the approximate cost of a traditional central inverter for that site and the installer's estimated profit and overhead. The Company combined this installer data with its own estimates of the costs of racking, labor, design, permitting, and Enphase microinverters for that site, as well as the amount of sales tax in each case, to determine the figures presented in the tables under the heading "Total System Cost." The Company advises the Staff that its estimates of the cost of racking and the tax rate were the same in each case for the Enphase microinverter system and the traditional central inverter system.

The installers provided the Company with estimates of the additional energy production that would be achieved by the Enphase microinverter systems over the estimated energy production of a traditional central inverter for an installation at that site as determined by PVWatts. The Company uses the term "Additional Energy Harvest" to refer to this additional energy produced by Enphase microinverter systems as a result of their ability to convert energy at the level of the individual solar module and their greater system uptime. Through its Enlighten web monitoring system, the Company has observed that the Additional Energy Harvest actually achieved by these systems to date has been higher than the installers' estimates.

The Company used estimates from the California Energy Commission ("CEC") to determine the average conversion efficiency of the Enphase microinverter and traditional central inverter systems. The Company advises the Staff that it has revised the CEC efficiency estimate for the Enphase microinverter system used in the residential installation case study based on further discussions with the installer of this system, who has informed the Company that he deployed the second-generation Enphase M190 microinverters in this installation. The Enphase M190 microinverter has a CEC efficiency estimate of 95%.

In each case, the Company estimated the uptime of the installed Enphase microinverter systems to be 99.8% based on the estimated failure rate of Enphase microinverter units, which the Company calculated based upon its analysis of the mean time between failure, or MTBF, of the Company's products and the Company's assumptions regarding the time to replace a failed microinverter unit. Field data collected by Westinghouse over a period of two years, discussed above and provided supplementally to the Staff, indicates a per unit failure rate of 0.207% for microinverters deployed in residential solar PV systems, which is consistent with the Company's estimates. The Company determined the system uptime of traditional central inverter systems based on the default value of 98% used by PVWatts. Based on the Company's discussions with participants in the solar industry, the Company believes 98% system uptime represents a reasonable estimate of system uptime for traditional central inverters.

The Company determined the length of warranties for the installed Enphase microinverters by reference to actual warranties provided by Enphase. The Company determined the length of warranties for the traditional central inverters based on information made publicly available by manufacturers of central inverters. The Company

advises the Staff that it has revised the length of warranty for the Enphase microinverter system used in the residential installation case study based on further discussions with the installer of this system, who has informed the Company that he deployed Enphase M190 microinverters in this installation. The Company provides a 15-year warranty for the Enphase M190 microinverter.

The Company advises the Staff that the \$/Watt DC figure is derived by dividing the line item "Total System Cost" by the size of the system in kilowatts.

The Company further advises the Staff that the LCOE figures represent the ratio of the total system's total life cycle cost, which is the sum of Total System Cost plus the present value of the total lifetime cost of the system, to its total lifetime energy output, as shown in the figure below. The total system's life cycle cost and the total lifetime energy output are the Company's estimates and calculations based on the data explained above.

$$\text{LCOE (\$/kWh)} = \left(\frac{\text{Installed Cost + Total Lifetime Cost of System (\$)}}{\text{Total Lifetime Energy Output (kWh)}} \right)$$

Further, the Company advises the Staff that the IRR figures represent the annualized effective compounded return rate or discount rate that makes the net present value (NPV) of all cash flows (both positive and negative) from the solar installations equal to zero. The IRR figures in the case studies are based on the cash flows (both positive and negative) from the perspective of the system owner.

Based on the information and estimates used to develop its case studies the Company believes that the installation in each case study is fairly representative of an installation of its size.

The Company advises the Staff that, to the best of its knowledge, alternatives to traditional central inverters and microinverters for residential and commercial solar PV installations were not commercially available in North America at the time of the study. Other currently available microinverter products have lower average power conversion efficiency, and therefore, the Company believes would not achieve the same or better results.

The Company further respectfully advises the Staff that, while the installers of the system installations referenced in the tables on pages 69 and 70 provided important data to the Company regarding these installations, it does not believe that it is required to name the installers or to file a consent with respect to the inclusion of such data in the Registration Statement. Rule 436(a) of Regulation C requires that "if any portion of the report or opinion of an expert or counsel is quoted or summarized as such in the registration statement or in a prospectus, the written consent of the expert or counsel shall be filed as an exhibit to the registration statement and shall expressly state that the expert or counsel consents to such quotation or summarization." In addition, Rule 436(b) of Regulation C requires a consent to be filed "if it is stated that any information contained in the Registration Statement has been reviewed or passed upon by any persons and that such information is set forth in the Registration Statement upon the authority of or in reliance upon such person as experts." The Company respectfully submits that neither installer referenced in the Registration Statement is an "expert"

within the SEC definition, that the Company has not relied upon the installers as experts, and that the Company has not made the affirmative statement contemplated by Rule 436(b) such that an expert's consent is required in connection with the tables referencing such installer data.

30. *Please disclose the phase-out dates and termination dates of material incentives that you mention on page 12.*

In response to the Staff's comment, the Company has provided additional disclosure on page 11-12 of the Amendment.

31. *Please describe the product qualification and certification process that you mention on page 15.*

The Company has provided additional disclosures on page 67 of the Amendment in response to the Staff's comment.

32. *Please describe the export control laws, regulations and requirements that limit which products you sell and where and to whom you sell you products as mentioned in the second sentence of the first risk factor on page 26.*

The Company respectfully advises the Staff that it is not aware of any current or proposed export control laws, regulations or requirements that place material limits on its ability to sell its products. The Company's products are not of a nature that implicate technology-specific restrictions under export control laws. In response to the Staff's comment, the Company has revised its disclosure on page 25 of the Amendment.

Industry Overview, page 62

33. *Please tell us whether:*

- *the industry data that you cite here and throughout your document is publicly available;*
- *the data was commissioned by you;*
- *the data was prepared for use in your registration statement;*
- *you have any relationship with the authors; and*
- *you are using the most recently available data.*

Also, tell us whether you obtained the consent of the authors to cite the data as you have done. Include in your response the California Solar Initiative and Westinghouse Solar data that you mention in your prospectus and the other data mentioned in the last paragraph on page 32.

The Company respectfully advises the Staff that (i) the industry data cited throughout the document is either generally available to the public or is available to the public on a subscription or purchase basis, (ii) none of the data used was commissioned by the Company or specifically prepared for use in the Registration Statement and (iii) every industry research firm named as a source is an independent party. The Company confirms that it does not have relationships with the independent research parties cited in the Registration Statement. As disclosed in the Registration Statement, the Company does have a business relationship with Westinghouse, as Westinghouse is a large solar installer that deploys Enphase microinverter solutions along with other inverter products.

The Company further advises the Staff that it believes it has used the most recently available data and has obtained the consent of the authors of the industry data other than the California Solar Initiative (CSI) and SEIA. California Solar Statistics, the official public reporting site of the CSI, presents actual program data exported from CSI weekly and can be viewed by the general public on CSI's website at <http://www.californiasolarstatistics.ca.gov/>. The general public can view program data summaries provided in several figures and tables, and can also download the complete Working Data Set for their own analysis. SEIA's information is also publicly available at <http://www.seia.org>. The Company supplementally provides the data used in the prospectus to the Staff.

Rapidly Expanding Distribution Channels, page 72

34. *Please tell us the criteria you used to determine which parties to name in this section, whether other unnamed parties also satisfy those criteria, how your disclosure fairly presents those parties' contribution to your business, and whether unnamed parties provide a greater contribution to your business. Also provide us this information with regard to the names in the first full sentence on page 79 and your reference to Wesco and GexPro on page 79.*

In response to the Staff's comment, the Company has revised its disclosure on pages 72 and 79. The Company advises the Staff that the solar distributors referenced on page 79 of the Amendment include all of its distributors contributing 5% or more of the Company's sales in the quarter ended March 31, 2011. The Company confirms that there are no unnamed parties who provide a greater contribution to the Company's business than those listed in this section.

The Company also has revised its disclosure on page 79 of the Amendment to delete the reference to Wesco and GexPro in response to the Staff's comment.

Expand our Technology Leadership, page 73

35. *You disclose here that you are developing a module for direct attachment of the microinverter to solar modules. However, your disclosure in this prospectus, including your graphics, suggests that your current module already does this. Please clarify.*

The Company respectfully advises the Staff that its current generation microinverter solutions depicted in the graphics of the Registration Statement mounts to the racking first, then connects to the DC cables from the junction box of the solar module and also has a separate system ground wire. The next-generation “AC Module” is expected to mount directly to the backsheet of the solar module which would eliminate the need for a DC junction box and separate system ground wire and would be considered “attached” in the industry. The Company has revised its disclosure on page 73 of the Amendment in response to the Staff’s comment.

Envoy Communications Gateway, page 75

36. *Please clarify how the device communicates with the “local web” if no broadband connection is available.*

Additional disclosure has been added to page 75 of the Amendment in response to the Staff’s comment.

Web-Based Software, page 78

37. *Please tell us why you do not believe that you must disclose the name of your “datacenter infrastructure provider” and the material terms of your agreement with the provider.*

In response to the Staff’s comment, the Company provided the name of its “datacenter infrastructure provider” on page 78 of the Amendment. The Company further advises the Staff that the Company’s agreement with Rackspace, US Inc. is a standard two-year hosting agreement that does not include any pricing information or any other material terms relevant to investors. The Company has further determined that the hardware and services the Company obtains from Rackspace is available from a number of other quality data center infrastructure providers at competitive prices.

Customers and Sales, page 78

38. *Please provide us with copies of your agreements with your distributors disclosed in the last risk factor on page 19, and tell us how you determined that these agreements need not be filed as exhibits to your registration statement.*

The Company respectfully advises the Staff that it enters into a standard form of an agreement for sale and purchase of its products with its distributors, which are terminable at the Company’s option at any time on ten days’ notice and do not contain any minimum purchasing or pricing terms. The Company supplementally provides copies of the agreements with two of its largest distributors in 2010 to the Staff, but it does not believe these agreements should be filed as exhibits pursuant to Item 601 of the Regulation S-K because they are “made in the ordinary course of business” and are of the type “such as ordinarily accompanies the kind of business conducted” by the Company. In addition, the Company does not substantially depend on any distributor agreement. Further, the form of distribution agreement is itself not material, and the filing of the distribution agreements or the form of distribution agreement would not provide material information to investors. The Company respectfully submits that none of the distribution

agreements or the form of distribution agreement falls within any category set forth in Items 601(b)(10)(ii)(A)-(D) of Regulation S-K requiring the Company to file these agreements as exhibits to the Registration Statement.

In addition, the risk factor on page 19 of the Amendment has been revised to further clarify that the percentages reflect the revenue of the two largest distributors collectively for the period referenced.

39. *Please disclose the material terms of your agreements with your strategic partners including your agreements with Siemens disclosed here and on page 72; include term and termination provisions. Tell us how you determined that you need not file these agreements as exhibits.*

In response to the Staff's comment, the Company has revised its disclosure on pages 72 and 79 of the Amendment. The Company deleted references to Suntech and Canadian Solar because the Company's relationship with Suntech is based only on a memorandum of understanding which merely provides a framework for the formal development agreement currently being negotiated by the parties, and the Canadian Solar development agreement merely formalizes a cooperative development effort that may lead to a supply agreement, but no such agreement has been negotiated yet.

The Company respectfully advises the Staff that the Siemens agreement, a reseller agreement, is an agreement that ordinarily accompanies the kind of business conducted by the Company and has yet to generate any meaningful revenue. Pursuant to Regulation S-K Item 601(b)(10)(ii)(B), if a contract is of a type that ordinarily accompanies the kind of business conducted by the Company, it is deemed to be ordinary course and need not be filed unless it is a "contract upon which the registrant's business is substantially dependent." The Company submits that the Company is not substantially dependent on the Siemens agreement as it has not generated any revenue and therefore does not believe that it is necessary to provide the description of this agreement or to file it as an exhibit to the Registration Statement. The Company supplementally advises the Staff that the Siemens agreement extends until January 31, 2014 and is terminable by either party upon one year prior notice.

40. *Please clarify what you mean by "2,200 installer and integrator partners." Are there parties with which you have a current contractual arrangement, or do you mean parties who have at some time in the past purchased a product from you?*

The Company respectfully advises the Staff that the "2,200 installer and integrator partners" referenced in the Registration Statement represent installers of the Company's products. However, most of the 2,200 installers purchase the Company's product via distributors and hence the Company does not have a contractual relationship with most of them. The Company is able to identify, interact and track the activities of the "2,200 installer and integrator partners" via Enlighten, its installer software portal that allows installers to manage their installations. The Company has clarified its disclosure on page 79 of the Amendment in response to the Staff's comment.

Manufacturing.... page 79

41. *Please disclose the material terms of your relationships with the manufacturers and suppliers disclosed in this section, including the term and termination provisions of material agreements.*

In response to the Staff's comment, the disclosure on pages 79 and 80 of the Amendment has been revised to describe in more detail the agreements and relationships with the Company's manufacturers and suppliers.

Intellectual Property, page 80

42. *We note your disclosure in this section that you license open source software. Please disclose the terms of your material licenses, including duration, termination provisions and material obligations of the parties.*

Additional disclosure has been added to page 81 of the Amendment in response to the Staff's comment.

Competition, page 81

43. *Please address both your competitive position relative to providers of central inverters and relative to providers of alternatives to central inverters. Also discuss competitive conditions; for example, if you aware of significant new competitors, please provide a discussion of these developments.*

The Company advises the Staff that its microinverter system competes with central inverter and other inverter technology as disclosed in the Competition section and the Risk Factors section on page 13. The Company believes that it offers a superior solution to traditional central inverter technology as well as compared to alternatives to central inverters and microinverter technology developed by new technology start-ups as outlined in Our Solution, Competitive Strengths and Our Products sections. The Company is currently not aware of any competing microinverter technology that is commercially as successful as its own although, as disclosed on page 82, there are a number of companies that have announced or are already shipping competing microinverter products. Additional disclosure has been provided on page 82 of the Amendment in response to the Staff's comment.

Executive Officers and Directors, page 83

44. *Please tell us why you have not disclosed Dennis Hollenbeck's business experience from July 2006 to December 2010.*

The Company respectfully advises the Staff that Mr. Hollenbeck attended to private matters during this time (primarily to care for a family member) and hence no business experience can be referenced from July 2006 to December 2010.

Board Composition, page 87

45. *Please tell us when you intend to disclose in the prospectus, relative to the time that you begin any meetings with prospective investors, the composition of each class of directors.*

The Company respectfully advises the Staff that it intends to determine and disclose the composition of each class of directors prior to finalizing its preliminary prospectus and prior to any meetings with prospective investors.

Base Salary, page 92

46. *It appears that your compensation committee considered objective factors - like company performance and individual performance - in determining the increases in base salary of your executive officers. Please provide specific disclosure regarding how the factors were reflected in the compensation decisions. Please refer to Regulation S-K Item 402(b)(2)(v) and (vii).*

In response to the Staff's comment, the Company has provided additional disclosure on pages 94-95 of the Amendment.

Cash Bonuses, page 93

47. *Please clarify how the committee determined the size of the \$133,325 payment to the Vice President of Worldwide Sales. From your disclosure that the payment was made for "exceeding his sales performance targets," it appears that the payment was based on more than a percentage of sales. Please disclose the target and how the amount of payment relative to the target was determined. See instruction 4 to Regulation S-K Item 402(b).*

Additional disclosure has been added to page 96 of the Amendment in response to the Staff's comment.

48. *Please clarify what the CFO did to strengthen your financial and accounting and organizational processes and how the committee determined that \$50,000 was the amount that should be paid for that activity.*

Additional disclosure has been added to page 96 of the Amendment in response to the Staff's comment.

49. *Please tell us why this section does not discuss the Vice President of Products' compensation for 2010.*

The Company respectfully advises the Staff that its Vice President of Products did not receive a cash bonus in 2010. In response to the Staff's comment, the Company has revised its disclosure on page 96 of the Amendment.

Equity Compensation, page 94

50. *Please discuss with specificity how the factors you cite resulted in the size of option that you granted to each named executive officer.*

In response to the Staff's comment, the Company has provided additional disclosure on pages 97- 98 of the Amendment.

Grant of Plan-Based Awards, page 98

51. *Please provide the disclosure in columns (b), (c), (d) and (e) of the table required by Regulation S-K Item 402(d) with regard the compensation plans for your CEO and Vice President of Worldwide Sales that you mention under "Cash Bonuses" on page 93.*

Additional disclosure has been added to page 101 of the Amendment in response to the Staff's comment.

52. *Please tell us how you concluded that the grant date fair value disclosed in the last column in the table does not reflect the actual economic value realized by the named executive officers as you state in the final sentence of footnote (2).*

In response to the Staff's comment, the disclosure in footnote (2) on page 101 of the Amendment has been revised to remove any reference to the actual economic value realized or realizable by the named executive officers.

53. *Please discuss the reasons for setting the vesting commencement dates before the grant date of options.*

The Company respectfully advises the Staff that such vesting terms generally apply to equity awards granted to new hires. The rationale for setting the vesting commencement date before the grant date of an option is to match the vesting commencement date to the date of an employee's commencement of employment with the Company which typically precedes the grant date.

54. *Please reconcile the grant date of Mr. Loebbaka's award disclosed here with the date in the last paragraph on page 102.*

The Company advises the Staff that the authority to grant awards under the 2006 Equity Incentive Plan rests solely with the Board of Directors. As such, all equity grants included in employment offers, including those made to named executive officers, are subject to Board approval. The grant date of June 3, 2010 disclosed in the table on page 101 reflects the date on which the Board approved the equity grant to Mr. Loebbaka. With respect to Mr. Loebbaka's award, the Company has revised the language on page 105 of the Amendment to clarify that the date of April 19, 2010 reflects the date of his employment offer and not the grant date of the award.

Employment Agreements, page 100

55. *Please tell us where you disclose in the prospectus the 6.5% of the outstanding common stock mentioned in Exhibit 10.5.*

Additional disclosure has been added to page 104 of the Amendment in response to the Staff's comment.

56. *Please reconcile your disclosure in the first sentence of your description of Raghuvveer Belur's employment agreement on page 103, regarding his employment on at will basis, with section 4 of Exhibit 10.9.*

The Company respectfully submits that it believes that Mr. Belur's employment is on an "at will" basis despite the term described in section 4 of his agreement because the Company can terminate his employment at any time for any reason, as described in section 7.1 of the agreement. The Company further advises the Staff that the severance provisions of Mr. Belur's employment agreement are described on page 106 of the Amendment, including any severance for termination without "cause".

2010 Potential Payments Upon Termination or Change of Control, page 104

57. *Please quantify how the new 2011 agreements that you disclose beginning on page 101 would change the amounts in the table.*

In response to the Staff's comment, the Company has provided additional disclosure to the table on pages 107-108 of the Amendment.

Compensation Risk Assessment, page 113

58. *Your disclosure suggests that you have not yet reviewed the risks associated with your compensation plans. Please reconcile this disclosure with the requirement of Regulation S-K Item 402(s).*

The Company acknowledges the Staff's comment and respectfully informs the Staff that the Company's board of directors is in the process of performing a comprehensive review of the Company's material compensation plans and programs in light of the requirement of Regulation S-K Item 402(s). The Company expects this review to be completed prior to the distribution of preliminary prospectuses, and the Company will update its disclosure accordingly in a subsequent amendment to the Registration Statement.

Certain Relationships..., page 114

59. *Please disclose the date of each transaction in the table on page 114. Also disclose the material rights of each class of preferred stock that you issued to related parties and the number of shares of common stock into which each share of preferred stock will convert in connection with this offering. If shareholder approval is required for such conversion, please disclose whether you obtained the required approval.*

The Company acknowledges the Staff's comment and respectfully informs the Staff that the various purchase dates of the Company's preferred stock reflected in the table on page 118 are as set forth at the bottom of such table. The table currently indicates that the Company's Series E preferred stock was purchased on three distinct dates and the accompanying footnotes to the

table indicate the particular date on which each purchaser purchased shares of the Company's Series E preferred Stock, as applicable. Additional disclosure has been added to pages 119-121 of the Amendment in response to the remainder of the Staff's comment.

60. *Please tell us why this section does not reflect the March 31, 2009 transaction with "key investors" mentioned on page F-13.*

In response to the Staff's comment, the Company has revised its disclosure on page 119 of the Amendment to reflect the March 31, 2009 transaction with "key investors".

61. *Please tell us which exhibit represents the voting agreement described on page 117.*

The Company acknowledges the Staff's comment and respectfully informs the Staff that the Voting Agreement described on page 123 of the Registration Statement will terminate and no longer be material to the Company upon the effectiveness of the Registration Statement and, as such, the Company believes it should not be filed as an exhibit to the Registration Statement. A clarifying modification has been made to page 123 in response to the Staff's comment.

62. *Please identify the related persons that are subject to this agreement, and disclose the material terms of the agreement, including the rights and covenants that will terminate upon completion of this offering.*

Additional disclosure has been added to page 123 of the Amendment in response to the Staff's comment.

Principal Stockholders, page 119

63. *With respect to each principal shareholder that is a legal entity, please identify clearly all natural persons who exercise the sole or shared voting and/or dispositive powers with respect to the shares held by that shareholder.*

In response to the Staff's comment, the Company has provided additional disclosures on page 126-127 of the Amendment.

Description of Capital Stock, page 122

Preferred Stock, page 122

64. *Please describe the conversion terms of the preferred stock.*

In response to the Staff's comment, the Company has provided additional disclosure on page 129 of the Amendment.

Warrants, page 123

65. *Please file as exhibits to this registration statement the warrants mentioned in the first and third paragraphs of this section.*

July 25, 2011
Page Twenty-Three

In response to the Staff's comment, the Company has filed the warrants as Exhibits 4.3, 4.4, 4.5 and 4.6 to the Amendment.

66. *Please ensure that the disclosure here and throughout your prospectus is current. For example, we note the warrant mentioned on page F-24.*

Additional disclosure has been added to page 130 of the Amendment in response to the Staff's comment.

Anti-Takeover Effects, page 125

67. *The last paragraph of the risk factor that you cite in this section as containing a description of anti-takeover positions indicates that it does not identify all anti-takeover provisions. Please provide complete disclosure required by Regulation S-K Item 202(a)(5).*

The Company has considered the Staff's comment and believes that it has fully described all the material anti-takeover provisions that are likely to apply to potential takeover attempts. Accordingly, in response to the Staff's comment, the Company has revised the relevant sentence on page 29 to remove any implication that there may be additional material anti-takeover provisions.

Material U.S. Federal Income and Estate Tax Consequences...., page 129

68. *It is inappropriate to disclaim liability for your disclosure as you appear to do in the first sentence of the second paragraph and in the last paragraph in this section. Please revise.*

In response to the Staff's comment, the Company has revised its disclosure on pages 136 and 139 of the Amendment.

Underwriting, page 133

69. *Refer to the last paragraph on page 136. Please provide more specific information regarding the financial advisory and investment banking services that the underwriters have provided to you. Also disclose the portion of your business derived from the supply and service agreements, the date the agreements end, and the exercise price of the warrant. File your agreements with the underwriters as exhibits to this registration statement.*

The Company respectfully advises the Staff that the underwriters have not performed financial advisory or investment banking services for the Company other than in connection with the Company's initial public offering. In response to the Staff's comment, the Company has revised the disclosure on page 143 of the Amendment.

Although the commercial supply and services agreements with MS Solar Solutions Corp. ("MSSS") are agreements with an affiliate of one of the underwriters, these agreements relate to the sale by the Company of its microinverters and related services to MSSS in

connection with programs for the installation of solar photovoltaic systems in the United States developed by MSSS, and as such are ordinary course transactions. The Company supplementally advises the Staff that, pursuant to these agreements, which were entered into on February 16, 2010, MSSS and the Company have agreed that MSSS will purchase the Company's microinverters for resale, and the Company will provide MSSS and its customers access to the Company's web-based monitoring software and support services. The commercial supply agreement will terminate on February 16, 2012, and the services agreement will terminate on the later of February 16, 2030 and the twentieth anniversary of the last Enphase solar system deployed by MSSS under the commercial supply agreement, in each case subject to extension by mutual agreement. The Company did not generate any revenues from these agreements through March 31, 2011. In connection with these agreements, on March 4, 2010, the Company issued to MSSS a warrant to purchase up to 100,000 shares at an initial exercise price of \$0.50 per share. This warrant is exercisable for three years from the date of issue, contingent upon MSSS purchasing 200,000 microinverters from the Company by March 2012. The Company believes it is very unlikely that this condition will be met; therefore the warrant will likely expire without being exercised.

There were no understandings between the Company and MSSS that Morgan Stanley & Co. LLC would be selected as an underwriter in the Company's initial public offering; therefore, the commercial supply and services agreements are not "underwriting contract[s] or agreement[s] ... pursuant to which the securities being registered are to be distributed." Accordingly, none of the commercial supply nor services agreements are of the type of contract required to be filed pursuant to Regulation S-K, Item 601(b)(1).

70. *The last paragraph on page 138 indicates that this document is merely a prospectus supplement. Please tell us what prospectus this document supplements and whether you intend to file that prospectus.*

In response to the Staff's comment, the Company has revised its disclosure on page 145 of the Amendment.

Financial Statements

71. *Please update the financial statements when required by Rule 3-12 of Regulation S-X.*

The Company respectfully advises the Staff that it will update its financial statements when required by Rule 3-12 of Regulation S-X.

Recent Sales, page II-2

72. *Please tell us where this section reflects the first common stock sale shown on page F-5.*

The Company respectfully advises the Staff that the first common stock sale shown on page F-5 is reflected in Item 15(a)(4) on page II-2.

73. *Please clarify which transactions you believe were exempt from registration based on Regulation D, and tell us when you filed the Form D for each such transaction.*

Additional disclosure has been added to page II-4 of the Amendment in response to the Staff's comment.

Exhibits and Financial Statement Schedules, page II-3

74. *Except as permitted for exhibits filed pursuant to Regulation S-K Item 601(b)(2), you should file complete copies of all documents you file as exhibits, including all attachments such as schedules, exhibits and annexes. Please refile Exhibits 4.2, 10.7, 10.10, 10.11, 10.12, 10.21, and 10.22 with the attachments that are currently missing.*

In response to the Staff's comment, the Company has filed complete copies of the exhibits that originally did not include all attachments, schedules or annexes, including Exhibits 4.2, 10.7, 10.10, 10.11, 10.12, 10.21 and 10.22. The Company advises the Staff that it will include Exhibits 10.16 through 10.21 with attachments and annexes in connection with the Company's response and amendment to its confidential treatment application.

75. *Please file your agreements with your "other executive officers" mentioned in the penultimate paragraph on page 95.*

In response to the Staff's comment, the Company has filed the agreements with its remaining executive officers, in addition to the agreements with its named executive officers, as Exhibits 10.29, 10.30, 10.31, 10.32, 10.33 and 10.34 to the Amendment.

Consents of Independent Registered Public Accounting Firms – Exhibits 23

76. *To the extent there is a delay in requesting effectiveness of your registration statement, or there is any change, other than typographical, made to the financial statements, or there have been intervening events since the prior filing that are material to the company, please provide a currently dated and signed consent from your independent accountants with your next amendment.*

The Company acknowledges the Staff's comment and confirms that a currently dated and signed consent from its independent accountants is filed with the Amendment.

July 25, 2011
Page Twenty-Six

Please do not hesitate to contact me at (650) 843-5070 if you have any questions or would like any additional information regarding these responses.

Sincerely,

/s/ John H. Sellers

cc: Paul B. Nahi, President and Chief Executive Officer, Enphase Energy, Inc.
Sanjeev Kumar, Chief Financial Officer, Enphase Energy, Inc.
Gary Caine, Deloitte & Touche LLP
Bruce K. Dallas, Davis Polk & Wardwell LLP
Marina Remennik, Cooley LLP

FIVE PALO ALTO SQUARE, 3000 EL CAMINO REAL, PALO ALTO, CA 94306-2155 T: (650) 843-5000 F: (650) 849-7400 WWW.COOLEY.COM